

INCIDENT CARD

599-142 00020 650.11 110000

4. INCIDENT *rec info S99-00242*

5. INCIDENT LOCATION

6. NAME - LAST - FIRST - MI *Shawano Co Sheriff* 7. D.O.B.

8. ADDRESS *7814* TX-HOME

11. CITY STATE ZIP 10. TX-BUSINESS

12. DETAILS
*rec'd they re: possible
 suspect veh re: fatal
 htr 11/10/99*

14. REC'D	15. DISP	16. 10-23	17. 10-24
13. DAY			
SUN 1	THU 5		
MON 2	FRI 6		
TUE 3	SAT 7		
WED 4			

18. ASSIGNED *MISO, 929
 Bushman 441*

19. REC. BY *921* 20. DIS. BY

22. TYPE OF REPORT
 1. INCIDENT
 2. ACCIDENT
 3. CITATION
 4. NONE

21. HOW REC'D.
 1. 911
 2. POLICE RADIO
 3. PHONE
 4. TTY
 5. IN PERSON
 6. ON VIEW
 7. OFF. OFF DUTY
 8. C.B. RADIO
 9. OTHER

23. STATUS
 1. UNFOUNDED
 2. BNL
 3. OTHER
 4. CLEARED
 5. EXCEPT CLEARED

24. DATE CLEARED *01/13/99*

25. OFFENSE TYPE
 1. ADULT NA
 2. JUVENILE
 3. UNKNOWN

21A. M.O.

39. (CODE S-SUSPECT W-WITNESS V-VICTIM O-OTHER)						
CODE	40. NAME-LAST	FIRST	MI	41. D.O.B.	42. ADDRESS	43. TELEPHONE

01/12/99 Arrangements to check this vehicle were made by Lt. Thorrington. When they found the vehicle Shawano Dispatcher phone MISO. The call was forwarded and we had the Officer describe the damage. IT was not what I was looking for and the driver had proof of an accident report car vs deer. M.J. Bushman

45. IF COMPLAINANT DIFFERENT THEN CALLER, ENTER NAME, ADDRESS, D.O.B., TELEPHONE.

46. IF CODE O (OTHER) IS USED IN FIELD #39, EXPLAIN.

INCIDENT REPORT: NOTE: IF SECTION 22 ABOVE HAS NUMBER 4 CHECKED, DO NOT GO BEYOND THIS LINE WITHOUT RECORDS SECTION BEING ADVISED, OR NO RECORD ENTRIES WILL BE MADE BELOW THIS LINE.

PROPERTY VALUE	26. PROPERTY	A. CURRENCY	B. JEWELRY	C. FURS CLOTHING	D. VEHICLE (LOCAL)	E. OFFICE EQUIPMENT	F. RADIO, TV CAMERAS	G. FIREARMS	H. HOUSE-HOLD GOODS
	STOLEN	\$	\$	\$	\$	\$	\$	\$	\$
	RECOVERED	\$	\$	\$	\$	\$	\$	\$	\$
	26. PROPERTY	I. CONSUMABLES	J. LIVESTOCK	K. DRUGS	L. MARINE ITEMS	M. CONSTRUCTION ITEMS	N. LAWN AND GARDEN	O. SPORTING GOODS	P. MISC BICYCLE
STOLEN	\$	\$	\$	\$	\$	\$	\$	\$	
RECOVERED	\$	\$	\$	\$	\$	\$	\$	\$	

27. PROPERTY RECOVERED: LOCALLY _____ OTHER JURISDICTION _____ (INSERT O OR L)

PROPERTY ITEMIZATION	PROPERTY STOLEN/RECOVERED ITEMIZATION, USE THE FOLLOWING FORMAT				
	28. QUANTITY	29. ARTICLE NAME	30. BRAND NAME	31. SERIAL NUMBER	32. CODE
					S R <input type="checkbox"/> <input type="checkbox"/>
					S R <input type="checkbox"/> <input type="checkbox"/>
					S R <input type="checkbox"/> <input type="checkbox"/>
					S R <input type="checkbox"/> <input type="checkbox"/>
					S R <input type="checkbox"/> <input type="checkbox"/>

33. PROPERTY DAMAGE AMOUNT \$ _____ 34. INSURANCE COMPANY _____

35. OFFICER ASSAULTED Y N 36. ARSON Y N 37. STRUCTURE CODE _____ 38. DAMAGE \$ _____

47. CIB	ENTERED <input type="checkbox"/>	CANCELLED <input type="checkbox"/>	48. TOTAL AMOUNT PROPERTY STOLEN \$ _____
NCIC	<input type="checkbox"/>	<input type="checkbox"/>	
OTHER BROADCAST	<input type="checkbox"/>	<input type="checkbox"/>	
			49. TOTAL AMOUNT PROPERTY RECOVERED \$ _____

50. IS REPORT CONTINUED? YES NO 51. CAUTION INDICATORS, ATLS ETC.

52. DATA PROCESS INFORMATION:

COMPUTER ENTERED DATE 10/15/99

MICROFILM INDEXED INITIAL KS

IS CASE CLASSIFICATION CORRECT? N

IF N HAS CORRECTION BEEN MADE? N

53. FILE APPROVAL

BY [Signature] DATE 10/13/99



SHAWANO COUNTY SHERIFF'S DEPARTMENT

N. Main Street Shawano, WI 54166

SHERIFF R.A. "Bob" SCHMIDT



LT. STEVE CONRADT

LT. JOHN GUTHO

Adm. -

Disp. -

FAX -

MILTON MARQUARDT

Chief Deputy

STEVE BORROUGHS

Jail Administrator

FACSIMILE TELEPHONE NUMBER 24 HOURS PER DAY

TELETYPE MNEMONIC: WI0590000 (SHSO)

FACSIMILE TRANSMISSION COVER PAGE

FROM:

ORGANIZATION:

TELEPHONE: 715-838-2111

TO: Lt Tharrington

FAX NO.:

DATE: 1-12-99

NUMBER OF PAGES: 2 (INCLUDING THIS COVER PAGE)

COMMENTS: Statement taken at our dept. Please advise if you need any follow up on this. Thank you!

NOTE: IF YOU DO NOT RECEIVE THE TOTAL NUMBER OF PAGES INDICATED, PLEASE CALL THE SENDING INDIVIDUAL LISTED ABOVE.

OPERATOR #: [Signature] (NUMBER & INITIALS)

SWPD Comp # 99-206

DATE: 1/12/98 CASE# _____ PAGE _____ OF _____

STATEMENT OF: Eugene W. Beer (Full Name & Middle Initial)

ADDRESS: [redacted] Belle Plaine Ave

PHONE: HOME [redacted] WORK _____

DATE OF BIRTH: [redacted]

Tues. morning 11:45 a.m. I saw a 1984-1987 GMC Suburban prime gray with some dark green on top. Parked at Pick 'n Save Shawano.

News last night said 15 year old boy killed near Mantowau (clover) 2 a.m. walking on road. Hit and Run. Gray parts of grill from Suburban^{found}. I thought this might only be a small chance, but you never know.

Eugene W. Beer

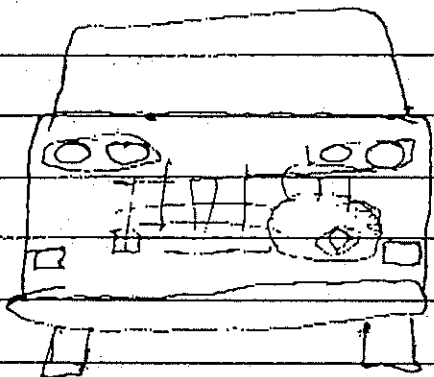

← damaged area

License [redacted]

GMC Suburban 1984-1987

SIGNED BY: Eugene W. Beer

WITNESSED BY: _____

599 IN 00209 107,011, 15,21000

INCIDENT CARD

4. INCIDENT: CS / Fatal H&R

5. INCIDENT LOCATION: 1313 S 12th St.

6. NAME - LAST - FIRST - MI: Anonymous

7. D.O.B.

8. ADDRESS

9. TX-HOME

11. CITY STATE ZIP

10. TX-BUSINESS

12. DETAILS: Reports Shawn Mott ¹⁸⁸⁰³ resides at [redacted] S 12th St phone [redacted] He has a dark blue older blazer and he would be capable of fatal H&R.

18. ASSIGNED: MISO 9219

19. REC. BY: 935

20. DIS. BY:

21. HOW REC'D.: 1. 911, 2. POLICE RADIO, 3. PHONE, 4. TTY, 5. IN PERSON, 6. ON VIEW, 7. OFF. OFF DUTY, 8. C.B. RADIO, 9. OTHER

22. TYPE OF REPORT: 1. INCIDENT, 2. ACCIDENT, 3. CITATION, 4. NONE

23. STATUS: 1. UNFOUNDED, 2. PNL, 3. OTHER, 4. CLEARED, 5. EXCEPT CLEARED

24. DATE CLEARED: 01/12/99

25. OFFENSE TYPE: 1. ADULT, 2. JUVENILE, 3. UNKNOWN

14. REC'D	15. DISP	16. 10-23	17. 10-24
SUN 1	THU 5		
MON 2	FRI 6		
TUE 3	SAT 7		
WED 4			

39. (CODE S-SUSPECT W-WITNESS V-VICTIM O-OTHER)					42. ADDRESS	43. TELEPHONE
CODE	40. NAME-LAST	FIRST	MI	41. D.O.B.		

He does have friends in that area so may possibly been driving on CR. 935/lms

(MTPN)

01-11-99 Officer Weyer checked address and area, no veh. matching in sight. However, Officer Weyer also remembers looking for this veh. and would match description given above, that it was invloled in a H&R in Manitowoc early last summer (someone else was driving). The veh. was found in garage, shades drawn over windows and padlocked. 938/KB KB

01/12/99 Contact was made by Lt. Bushman with Shawn Mott at [redacted] S.12thMtwc. He was very cooperative and invited Off. to accompany him to the locked garage. It was full of personal items from the recent move to the residence. He does not have nor did he have any Chev. matching the suspect vehicle. He did say a friend of his who stops often did have a blue Chev 4WD matching the description. Last name Luedke living on a farm off English Lake Rd. near Newtonburg Road. Vehicle was checked and found to not have damage. M.J. Bushman

599 IN 00297 16,310,1 15,2000

INCIDENT CARD

4. INCIDENT CS/S99-00242

5. INCIDENT LOCATION

6. NAME- LAST - FIRST - MI 7. D.O.B.
 Anonymus 2

8. ADDRESS 9. TX-HOME

11. CITY STATE ZIP 10. TX-BUSINESS

12. DETAILS
 Requesting we check vehicle of Robert E. Hochkammer dob: [redacted] Caller believes he drives a vehicle similar to suspect vehicle in the fatal H&R. Resides [redacted] S. 30th #8 Manitowoc. Caller believes he works at Schneider Cheese. See attached 10-27.

14. REC'D 15. DISP 16. 10-23 17. 10-24

13. DAY
 SUN 1 THU 5
 MON 2 FRI 6
 TUE 3 SAT 7
 WED 4

18. ASSIGNED MT50 929
 Glaeser 417

19. REC. BY 20. DIS. BY
 414

21. HOW REC'D.
 1. 911
 2. POLICE RADIO
 3. PHONE
 4. TTY
 5. IN PERSON
 6. ON VIEW
 7. OFF. OFF DUTY
 8. C.B. RADIO
 9. OTHER

22. TYPE OF REPORT
 1. INCIDENT
 2. ACCIDENT
 3. CITATION
 4. NONE

23. STATUS
 1. UNFOUNDED
 2. PNL
 3. OTHER
 4. CLEARED
 5. EXCEPT CLEARED

24. DATE CLEARED 01/14/99

25. OFFENSE TYPE
 1. ADULT NA
 2. JUVENILE
 3. UNKNOWN

39. (CODE S-SUSPECT W-WITNESS V-VICTIM O-OTHER)						
CODE	40. NAME-LAST	FIRST	MI	41. D.O.B.	42. ADDRESS	43. TELEPHONE
0	HOCHKAMMER	ROBERT	E	[redacted]	[redacted] S 30th St #8, Manitowoc	

01/12/99 @ 0647 Hrs.: I, Deputy E. Glaeser, checked the address of [redacted] S 30th St #8, Manitowoc, reference a possible hit and run vehicle. Telephone contact was made with the owner of the vehicle, ROBERT HOCHKAMMER. HOCHKAMMER was very compliant and did show me his vehicle. The vehicle is a 1986 blue GMC truck bearing WI RP EWA605.

Upon checking the front of the vehicle which was located in a garage at this property, it did have very minor grill damage on the right side consisting of a crack near the frame around the lights, and there was one small area where approximately 3" of 1/2" wide flange was missing.

It should be noted this vehicle does not match the suspect vehicle description.
 EJGlaeser *EJG* /bjc

45. IF COMPLAINANT DIFFERENT THEN CALLER, ENTER NAME, ADDRESS, D.O.B., TELEPHONE.

46. IF CODE O (OTHER) IS USED IN FIELD #39, EXPLAIN.

INCIDENT REPORT: NOTE: IF SECTION 22 ABOVE HAS NUMBER 4 CHECKED, DO NOT GO BEYOND THIS LINE WITHOUT RECORDS SECTION BEING ADVISED, OR NO RECORD ENTRIES WILL BE MADE BELOW THIS LINE.

PROPERTY VALUE	26. PROPERTY	A. CURRENCY	B. JEWELRY	C. FURS CLOTHING	D. VEHICLE (LOCAL)	E. OFFICE EQUIPMENT	F. RADIO, TV CAMERAS	G. FIREARMS	H. HOUSE-HOLD GOODS
	STOLEN	\$	\$	\$	\$	\$	\$	\$	\$
	RECOVERED	\$	\$	\$	\$	\$	\$	\$	\$
	26. PROPERTY	I. CONSUMABLES	J. LIVESTOCK	K. DRUGS	L. MARINE ITEMS	M. CONSTRUCTION ITEMS	N. LAWN AND GARDEN	O. SPORTING GOODS	P. MISC BICYCLE
	STOLEN	\$	\$	\$	\$	\$	\$	\$	\$
	RECOVERED	\$	\$	\$	\$	\$	\$	\$	\$

27. PROPERTY RECOVERED: LOCALLY _____ OTHER JURISDICTION _____ (INSERT O OR L)

PROPERTY ITEMIZATION	PROPERTY STOLEN/RECOVERED ITEMIZATION, USE THE FOLLOWING FORMAT				
	28. QUANTITY	29. ARTICLE NAME	30. BRAND NAME	31. SERIAL NUMBER	32. CODE
					S R <input type="checkbox"/> <input type="checkbox"/>
					S R <input type="checkbox"/> <input type="checkbox"/>
					S R <input type="checkbox"/> <input type="checkbox"/>
					S R <input type="checkbox"/> <input type="checkbox"/>

33. PROPERTY DAMAGE AMOUNT \$ _____ 34. INSURANCE COMPANY _____

35. OFFICER ASSAULTED Y N 36. ARSON Y N 37. STRUCTURE CODE _____ 38. DAMAGE \$ _____

47. CIB	ENTERED <input type="checkbox"/>	CANCELLED <input type="checkbox"/>	48. TOTAL AMOUNT PROPERTY STOLEN \$ _____
NCIC	<input type="checkbox"/>	<input type="checkbox"/>	
OTHER BROADCAST	<input type="checkbox"/>	<input type="checkbox"/>	49. TOTAL AMOUNT PROPERTY RECOVERED \$ _____

50. IS REPORT CONTINUED? YES NO 51. CAUTION INDICATORS, ATLS ETC.

52. DATA PROCESS INFORMATION:

COMPUTER ENTERED DATE 01/15/99

MICROFILM INDEXED INITIAL AS

IS CASE CLASSIFICATION CORRECT? Y N
IF N HAS CORRECTION BEEN MADE? N N

53. FILE APPROVAL
BY [Signature] DATE 01/19/99

399 INE 00502 10.20.99 1521000

4. INCIDENT CS/599-00242

5. INCIDENT LOCATION CR + Silver Creek Rd.

6. NAME - LAST - FIRST - MI Anonymous (a) 7. D.O.B.

8. ADDRESS 9. TX-HOME

11. CITY STATE ZIP 10. TX-BUSINESS

12. DETAILS
 Rpts observing vehicle
 RP # BC 24686 w/o front
 grill parked in Kimberly

INCIDENT CARD

18. ASSIGNED Eushmas 4911

19. REC. BY 901 20. DIS. BY 901

21. HOW REC'D.
 1. 911
 2. POLICE RADIO
 3. PHONE
 4. TTY
 5. IN PERSON
 6. ON VIEW
 7. OFF. OFF DUTY
 8. C.B. RADIO
 9. OTHER

22. TYPE OF REPORT
 1. INCIDENT
 2. ACCIDENT
 3. CITATION
 4. NONE

23. STATUS
 1. UNFOUNDED
 2. PNL
 3. OTHER
 4. CLEARED
 5. EXCEPT CLEARED

24. DATE CLEARED 10/21/99

25. OFFENSE TYPE
 1. ADULT NA
 2. JUVENILE
 3. UNKNOWN

14. REC'D	15. DISP	16. 10-23	17. 10-24
13. DAY			
SUN 1	THU 5		
MON 2	FRI 6		
TUE 3	SAT 7		
WED 4			

39. (CODE S-SUSPECT W-WITNESS V-VICTIM O-OTHER)

CODE	40. NAME - LAST	FIRST	MI	41. D.O.B.	42. ADDRESS	43. TELEPHONE

01/20/99 Teletype sent to Appleton PD and requested assistance, they forwarded to Outagamie Co. SO. Vehicle was currently in the Town of Grand Chute. Off. on scene phoned MTSO with provided number and advised this is not the vehicle we are looking for as the damage is minor. M.J.Eushman

45. IF COMPLAINANT DIFFERENT THEN CALLER, ENTER NAME, ADDRESS, D.O.B., TELEPHONE.

46. IF CODE O (OTHER) IS USED IN FIELD #39, EXPLAIN.

INCIDENT REPORT: NOTE: IF SECTION 22 ABOVE HAS NUMBER 4 CHECKED, DO NOT GO BEYOND THIS LINE WITHOUT RECORDS SECTION BEING ADVISED, OR NO RECORD ENTRIES WILL BE MADE BELOW THIS LINE.

PROPERTY VALUE	26. PROPERTY	A. CURRENCY	B. JEWELRY	C. FURS CLOTHING	D. VEHICLE (LOCAL)	E. OFFICE EQUIPMENT	F. RADIO, TV CAMERAS	G. FIREARMS	H. HOUSE-HOLD GOODS
	STOLEN	\$	\$	\$	\$	\$	\$	\$	\$
	RECOVERED	\$	\$	\$	\$	\$	\$	\$	\$
	26. PROPERTY	I. CONSUMABLES	J. LIVESTOCK	K. DRUGS	L. MARINE ITEMS	M. CONSTRUCTION ITEMS	N. LAWN AND GARDEN	O. SPORTING GOODS	P. MISC BICYCLE
STOLEN	\$	\$	\$	\$	\$	\$	\$	\$	
RECOVERED	\$	\$	\$	\$	\$	\$	\$	\$	

27. PROPERTY RECOVERED: LOCALLY _____ OTHER JURISDICTION _____ (INSERT O OR L)

PROPERTY ITEMIZATION	PROPERTY STOLEN/RECOVERED ITEMIZATION, USE THE FOLLOWING FORMAT				
	28. QUANTITY	29. ARTICLE NAME	30. BRAND NAME	31. SERIAL NUMBER	32. CODE
					S R <input type="checkbox"/> <input type="checkbox"/>
					S R <input type="checkbox"/> <input type="checkbox"/>
					S R <input type="checkbox"/> <input type="checkbox"/>
					S R <input type="checkbox"/> <input type="checkbox"/>
					S R <input type="checkbox"/> <input type="checkbox"/>

33. PROPERTY DAMAGE AMOUNT \$ _____

34. INSURANCE COMPANY _____

35. OFFICER ASSAULTED Y N

36. ARSON Y N

37. STRUCTURE CODE _____ 38. DAMAGE \$ _____

	ENTERED	CANCELLED
47. CIB	<input type="checkbox"/>	<input type="checkbox"/>
NCIC	<input type="checkbox"/>	<input type="checkbox"/>
OTHER BROADCAST	<input type="checkbox"/>	<input type="checkbox"/>

48. TOTAL AMOUNT PROPERTY STOLEN \$ _____

49. TOTAL AMOUNT PROPERTY RECOVERED \$ _____

50. IS REPORT CONTINUED? YES NO

51. CAUTION INDICATORS, ATLS ETC.

52. DATA PROCESS INFORMATION:

COMPUTER ENTERED DATE 10/11/99
 MICROFILM INDEXED INITIAL AS

53. FILE APPROVAL

IS CASE CLASSIFICATION CORRECT? Y N
 IF N HAS CORRECTION BEEN MADE? Y N

BY _____ DATE

899 No 00361 6301, 52000

INCIDENT CARD

18. ASSIGNED *921*
Glaser *4/17*

19. REC. BY *921* 20. DIS. BY

21. HOW REC'D.
 1. 911
 2. POLICE RADIO
 3. PHONE
 4. TTY
 5. IN PERSON
 6. ON VIEW
 7. OFF. OFF DUTY
 8. C.B. RADIO
 9. OTHER

22. TYPE OF REPORT
 1. INCIDENT
 2. ACCIDENT
 3. CITATION
 4. NONE

23. STATUS
 1. UNFOUNDED
 2. PNL
 3. OTHER
 4. CLEARED
 5. EXCEPT CLEARED

24. DATE CLEARED *03/09/99*

25. OFFENSE TYPE
 1. ADULT NA
 2. JUVENILE
 3. UNKNOWN

4. INCIDENT *CS #00242*

5. INCIDENT LOCATION

6. NAME - LAST - FIRST - MI *ANONYMOUS* 7. D.O.B.

8. ADDRESS 9. TX-HOME

11. CITY STATE ZIP 10. TX-BUSINESS

12. DETAILS *see attached*

13. DAY
 SUN 1 THU 5
 MON 2 FRI 6
 TUE 3 SAT 7
 WED

39. (CODE S-SUSPECT W-WITNESS V-VICTIM O-OTHER)						
CODE	40. NAME-LAST	FIRST	MI	41. D.O.B.	42. ADDRESS	43. TELEPHONE

01/22/99 @ 0935 Hrs. I Deputy E. Glaeser checked the area of 800 block of Jay street for a vehicle matching the dscription on this crimestopper report and was unable to locate it or anything close to it. In checking this file it does appear Lt. Thorington may have done some work on this INC also.

NO REPORT ON FILE
899 00242

EG *AVG*

45. IF COMPLAINANT DIFFERENT THEN CALLER, ENTER NAME, ADDRESS, D.O.B., TELEPHONE.

46. IF CODE O (OTHER) IS USED IN FIELD #39, EXPLAIN.

INCIDENT REPORT: NOTE: IF SECTION 22 ABOVE HAS NUMBER 4 CHECKED, DO NOT GO BEYOND THIS LINE WITHOUT RECORDS SECTION BEING ADVISED, OR NO RECORD ENTRIES WILL BE MADE BELOW THIS LINE.

PROPERTY VALUE	26. PROPERTY	A. CURRENCY	B. JEWELRY	C. FURS CLOTHING	D. VEHICLE (LOCAL)	E. OFFICE EQUIPMENT	F. RADIO, TV CAMERAS	G. FIREARMS	H. HOUSE-HOLD GOODS
	STOLEN	\$	\$	\$	\$	\$	\$	\$	\$
	RECOVERED	\$	\$	\$	\$	\$	\$	\$	\$
	26. PROPERTY	I. CONSUM-ABLES	J. LIVESTOCK	K. DRUGS	L. MARINE ITEMS	M. CONSTRUCTION ITEMS	N. LAWN AND GARDEN	O. SPORTING GOODS	P. MISC BICYCLE
	STOLEN	\$	\$	\$	\$	\$	\$	\$	\$
	RECOVERED	\$	\$	\$	\$	\$	\$	\$	\$

27. PROPERTY RECOVERED: LOCALLY ____ OTHER JURISDICTION ____ (INSERT O OR L)

PROPERTY ITEMIZATION	PROPERTY STOLEN/RECOVERED ITEMIZATION, USE THE FOLLOWING FORMAT				31. SERIAL NUMBER	32. CODE		
	28. QUANTITY	29. ARTICLE NAME	30. BRAND NAME					
							S <input type="checkbox"/>	R <input type="checkbox"/>
							S <input type="checkbox"/>	R <input type="checkbox"/>
							S <input type="checkbox"/>	R <input type="checkbox"/>
							S <input type="checkbox"/>	R <input type="checkbox"/>

33. PROPERTY DAMAGE AMOUNT \$ _____

34. INSURANCE COMPANY _____

35. OFFICER ASSAULTED Y N

36. ARSON Y N

37. STRUCTURE CODE _____ 38. DAMAGE \$ _____

47. CIB ENTERED CANCELLED
 NCIC
 OTHER BROADCAST

48. TOTAL AMOUNT PROPERTY STOLEN \$ _____

49. TOTAL AMOUNT PROPERTY RECOVERED \$ _____

50. IS REPORT CONTINUED? YES NO

51. CAUTION INDICATORS, ATLS ETC.

52. DATA PROCESS INFORMATION:

COMPUTER ENTERED DATE
 MICROFILM INDEXED INITIAL _____

53. FILE APPROVAL

IS CASE CLASSIFICATION CORRECT? Y N
 IF N HAS CORRECTION BEEN MADE? Y N

BY 

DATE 030899

S99 NY U0379 16,310,11,11,410,0,2

INCIDENT CARD

4. INCIDENT
CS/S99-00242

5. INCIDENT LOCATION
CTH CR

6. NAME - LAST - FIRST - MI
[REDACTED] 7. D.O.B.
[REDACTED]

8. ADDRESS
[REDACTED] 9. TX HOME
[REDACTED]

11. CITY STATE ZIP
[REDACTED] 10. TX-BUSINESS
[REDACTED]

12. DETAILS
SAW A DK OR BLK CHEV 4x4 PLUP
AT PICK-N-SAVE IN SITEB W/OUT A
GRILL, DENT IN BUMPER ON PASS.
SIDE; PLATE # RSE-298

1-13-99 913

14. REC'D.	15. DISP.	16. 10-23	17. 10-24
13. DAY			
SUN 1	THU 5		
MON 2	FRI 6		
TUE 3	SAT 7		
WED 4			

18. ASSIGNED
MTSC 9/29
Bushman H.H.I.

19. REC. BY 932 20. DIS. BY 932

21. HOW REC'D.
1. 911
2. POLICE RADIO
3. PHONE
4. TTY
5. IN PERSON
6. ON VIEW
7. OFF. OFF DUTY
8. C.B. RADIO
9. OTHER

22. TYPE OF REPORT:
1. INCIDENT
2. ACCIDENT
3. CITATION
4. NONE

23. STATUS
1. UNFOUNDED
2. PNL
3. OTHER
4. CLEARED
5. EXCEPT CLEARED

24. DATE CLEARED 10/12/99

25. OFFENSE TYPE
1. ADULT NA
2. JUVENILE
3. UNKNOWN

21A. M.O.
[REDACTED]

39. (CODE S-SUSPECT W-WITNESS V-VICTIM O-OTHER)						
CODE	40. NAME - LAST	FIRST	MI	41. D.O.B.	42. ADDRESS	43. TELEPHONE

01/13/98 Wrong type vehicle, was not checked by a PD.M.J. Bushman

S/C O A I N I R R C

45. IF COMPLAINANT DIFFERENT THEN CALLER, ENTER NAME, ADDRESS, D.O.B., TELEPHONE.

46. IF CODE O (OTHER) IS USED IN FIELD #39, EXPLAIN.

INCIDENT REPORT: NOTE: IF SECTION 22 ABOVE HAS NUMBER 4 CHECKED, DO NOT GO BEYOND THIS LINE WITHOUT RECORDS SECTION BEING ADVISED, OR NO RECORD ENTRIES WILL BE MADE BELOW THIS LINE.

PROPERTY VALUE	26. PROPERTY	A. CURRENCY	B. JEWELRY	C. FURS CLOTHING	D. VEHICLE (LOCAL)	E. OFFICE EQUIPMENT	F. RADIO, TV CAMERAS	G. FIREARMS	H. HOUSE-HOLD GOODS
	STOLEN	\$	\$	\$	\$	\$	\$	\$	\$
	RECOVERED	\$	\$	\$	\$	\$	\$	\$	\$
	26. PROPERTY	I. CONSUMABLES	J. LIVESTOCK	K. DRUGS	L. MARINE ITEMS	M. CONSTRUCTION ITEMS	N. LAWN AND GARDEN	O. SPORTING GOODS	P. MISC BICYCLE
STOLEN	\$	\$	\$	\$	\$	\$	\$	\$	
RECOVERED	\$	\$	\$	\$	\$	\$	\$	\$	

27. PROPERTY RECOVERED: LOCALLY _____ OTHER JURISDICTION _____ (INSERT O OR L)

PROPERTY ITEMIZATION	PROPERTY STOLEN/RECOVERED ITEMIZATION, USE THE FOLLOWING FORMAT				
	28. QUANTITY	29. ARTICLE NAME	30. BRAND NAME	31. SERIAL NUMBER	32. CODE
					S R <input type="checkbox"/> <input type="checkbox"/>
					S R <input type="checkbox"/> <input type="checkbox"/>
					S R <input type="checkbox"/> <input type="checkbox"/>
					S R <input type="checkbox"/> <input type="checkbox"/>
					S R <input type="checkbox"/> <input type="checkbox"/>

33. PROPERTY DAMAGE AMOUNT \$ _____

34. INSURANCE COMPANY _____

35. OFFICER ASSAULTED Y N

36. ARSON Y N

37. STRUCTURE CODE _____

38. DAMAGE \$ _____

47. CIB ENTERED CANCELLED
 NCIC
 OTHER BROADCAST

48. TOTAL AMOUNT PROPERTY STOLEN \$ _____

49. TOTAL AMOUNT PROPERTY RECOVERED \$ _____

50. IS REPORT CONTINUED? YES NO

51. CAUTION INDICATORS, ATLS ETC.

52. DATA PROCESS INFORMATION:

COMPUTER ENTERED DATE 01/21/99

MICROFILM INDEXED INITIAL KS

IS CASE CLASSIFICATION CORRECT? Y N
 IF N HAS CORRECTION BEEN MADE? Y N

53. FILE APPROVAL

BY *GR*

DATE 01/21/99

45. IF COMPLAINANT DIFFERENT THEN CALLER, ENTER NAME, ADDRESS, D.O.B., TELEPHONE.

46. IF CODE O (OTHER) IS USED IN FIELD #39, EXPLAIN.

INCIDENT REPORT: NOTE: IF SECTION 22 ABOVE HAS NUMBER 4 CHECKED, DO NOT GO BEYOND THIS LINE WITHOUT RECORDS SECTION BEING ADVISED, OR NO RECORD ENTRIES WILL BE MADE BELOW THIS LINE.

PROPERTY VALUE	26. PROPERTY	A. CURRENCY	B. JEWELRY	C. FURS CLOTHING	D. VEHICLE (LOCAL)	E. OFFICE EQUIPMENT	F. RADIO, TV CAMERAS	G. FIREARMS	H. HOUSE-HOLD GOODS
	STOLEN	\$	\$	\$	\$	\$	\$	\$	\$
	RECOVERED	\$	\$	\$	\$	\$	\$	\$	\$
	26. PROPERTY	I. CONSUMABLES	J. LIVESTOCK	K. DRUGS	L. MARINE ITEMS	M. CONSTRUCTION ITEMS	N. LAWN AND GARDEN	O. SPORTING GOODS	P. MISC BICYCLE
STOLEN	\$	\$	\$	\$	\$	\$	\$	\$	
RECOVERED	\$	\$	\$	\$	\$	\$	\$	\$	

27. PROPERTY RECOVERED: LOCALLY _____ OTHER JURISDICTION _____ (INSERT O OR L)

PROPERTY ITEMIZATION	PROPERTY STOLEN/RECOVERED ITEMIZATION, USE THE FOLLOWING FORMAT				
	28. QUANTITY	29. ARTICLE NAME	30. BRAND NAME	31. SERIAL NUMBER	32. CODE
					S R <input type="checkbox"/> <input type="checkbox"/>
					S R <input type="checkbox"/> <input type="checkbox"/>
					S R <input type="checkbox"/> <input type="checkbox"/>
					S R <input type="checkbox"/> <input type="checkbox"/>
					S R <input type="checkbox"/> <input type="checkbox"/>

33. PROPERTY DAMAGE AMOUNT \$ _____

34. INSURANCE COMPANY _____

35. OFFICER ASSAULTED Y N

36. ARSON Y N

37. STRUCTURE CODE _____ 38. DAMAGE \$ _____

47. CIB ENTERED CANCELLED
 NCIC
 OTHER BROADCAST

48. TOTAL AMOUNT PROPERTY STOLEN \$ _____

49. TOTAL AMOUNT PROPERTY RECOVERED \$ _____

50. IS REPORT CONTINUED? YES NO

51. CAUTION INDICATORS, ATLS ETC.

52. DATA PROCESS INFORMATION:

COMPUTER ENTERED DATE 10/20/99

MICROFILM INDEXED INITIAL KS

IS CASE CLASSIFICATION CORRECT? N
 IF N HAS CORRECTION BEEN MADE? N

53. FILE APPROVAL

BY GC

DATE 10/20/99

S99 INC 00554 16,30.11, 16,010.00

4. INCIDENT
CS/599-00242

5. INCIDENT LOCATION

6. NAME LAST FIRST MI (3573) 7. D.O.B.

8. ADDRESS 9. TX-HOME

11. CITY STATE ZIP 10. TX-BUSINESS

12. DETAILS
COMP. BELIEVES SUSPECT IN
FATAL HIT + RUN IS RICHARD
ALAN BARTELME (782)
OWNER OF NORTHEIM TAVERN
SEE ATTACHED

14. REC'D.	15. DISP.	16. 10-23	17. 10-24
13. DAY			
SUN 1	THU 5		
MON 2	FRI 6		
TUE 3	SAT 7		
WED 4			

INCIDENT CARD

18. ASSIGNED
MTSD 9/2/99
RUSHMAN 4/4/1

19. REC. BY 20. DIS. BY
946

21. HOW REC'D.
1. 911
2. POLICE RADIO
3. PHONE
4. TTY
5. IN PERSON
6. ON VIEW
7. OFF. OFF DUTY
8. C.B. RADIO
9. OTHER
21A. M.O.

22. TYPE OF REPORT
1. INCIDENT
2. ACCIDENT
3. CITATION
4. NONE

23. STATUS
1. UNFOUNDED
2. PNL
3. OTHER
4. CLEARED
5. EXCEPT CLEARED

24. DATE CLEARED 01/19/99

25. OFFENSE TYPE
1. ADULT NA
2. JUVENILE
3. UNKNOWN

39. (CODE S-SUSPECT W-WITNESS V-VICTIM O-OTHER)				42. ADDRESS	43. TELEPHONE
CODE	40. NAME-LAST	FIRST	MI	41. D.O.B.	

01/19/99 Bartelme was checked out early on and the vehicle he owned which matched the suspect vehicle is parked and inoperable behind the bar in Northheim. It was smashed up in late summer 1998. There was a neighbor talked too about the possibility of a second vehicle matching desription, it was doubtful, but the neighbor will keep watch. M.J.B.

45. IF COMPLAINANT DIFFERENT THEN CALLER, ENTER NAME, ADDRESS, D.O.B., TELEPHONE.

46. IF CODE O (OTHER) IS USED IN FIELD #39, EXPLAIN.

INCIDENT REPORT: NOTE: IF SECTION 22 ABOVE HAS NUMBER 4 CHECKED, DO NOT GO BEYOND THIS LINE WITHOUT RECORDS SECTION BEING ADVISED, OR NO RECORD ENTRIES WILL BE MADE BELOW THIS LINE.

PROPERTY VALUE	26. PROPERTY	A. CURRENCY	B. JEWELRY	C. FURS CLOTHING	D. VEHICLE (LOCAL)	E. OFFICE EQUIPMENT	F. RADIO, TV CAMERAS	G. FIREARMS	H. HOUSE-HOLD GOODS
	STOLEN	\$	\$	\$	\$	\$	\$	\$	\$
	RECOVERED	\$	\$	\$	\$	\$	\$	\$	\$
	26. PROPERTY	I. CONSUMABLES	J. LIVESTOCK	K. DRUGS	L. MARINE ITEMS	M. CONSTRUCTION ITEMS	N. LAWN AND GARDEN	O. SPORTING GOODS	P. MISC BICYCLE
STOLEN	\$	\$	\$	\$	\$	\$	\$	\$	
RECOVERED	\$	\$	\$	\$	\$	\$	\$	\$	

27. PROPERTY RECOVERED: LOCALLY _____ OTHER JURISDICTION _____ (INSERT O OR L)

PROPERTY ITEMIZATION	PROPERTY STOLEN/RECOVERED ITEMIZATION, USE THE FOLLOWING FORMAT						
	28. QUANTITY	29. ARTICLE NAME	30. BRAND NAME	31. SERIAL NUMBER	32. CODE		
						S	R
						<input type="checkbox"/>	<input type="checkbox"/>
						S	R
						<input type="checkbox"/>	<input type="checkbox"/>
					S	R	
					<input type="checkbox"/>	<input type="checkbox"/>	
					S	R	
					<input type="checkbox"/>	<input type="checkbox"/>	

33. PROPERTY DAMAGE AMOUNT \$ _____

34. INSURANCE COMPANY _____

35. OFFICER ASSAULTED Y N

36. ARSON Y N

37. STRUCTURE CODE _____

38. DAMAGE \$ _____

47. CIB ENTERED CANCELLED
 NCIC
 OTHER BROADCAST

48. TOTAL AMOUNT PROPERTY STOLEN \$ _____

49. TOTAL AMOUNT PROPERTY RECOVERED \$ _____

50. IS REPORT CONTINUED? YES NO

51. CAUTION INDICATORS, ATLS ETC.

52. DATA PROCESS INFORMATION:

COMPUTER ENTERED DATE 10/20/99
 MICROFILM INDEXED INITIAL AS

53. FILE APPROVAL

IS CASE CLASSIFICATION CORRECT?
 IF N HAS CORRECTION BEEN MADE?

Y N
 Y N

BY [Signature]

DATE 10/19/99

399 IV 00002 163011 152000 99 99 99

4. INCIDENT
CRIMESTOPPER / 399-00242

5. INCIDENT LOCATION
S. 30 ST.

6. NAME - LAST-FIRST-MI
[REDACTED]

7. D.O.B.
[REDACTED]

8. ADDRESS
[REDACTED]

9. TX-HOME
[REDACTED]

10. TX-BUSINESS
[REDACTED]

11. CITY STATE ZIP
[REDACTED]

12. DETAILS
REPORTS PICK UP w/ GRILLE DAMAGE
IN SUPER SAVER PARKING LOT TODAYS DATE
PLATE AE21234 RUSTY BROWN & GRAY
10 COLOR WISHES TO REMAIN ANONYMOUS

13. DAY
SUN 1 THU 5
MON 2 FRI 6
TUE 3 SAT 7
WED 4

14. REC'D
15:15

15. DISP
15:15

16. 10-23
15:15

17. 10-24
15:15

18. ASSIGNED INFORMATION 929 91311

19. REC. BY 939

20. DIS. BY

21. HOW REC'D.
1. 911
2. POLICE RADIO
3. PHONE
4. TTY
5. IN PERSON
6. ON VIEW
7. OFF. OFF DUTY
8. C.B. RADIO
9. OTHER

22. TYPE OF REPORT
1. INCIDENT
2. ACCIDENT
3. CITATION
4. NONE

23. STATUS
1. UNFOUNDED
2. PNL
3. OTHER
4. CLEARED
5. EXCEPT CLEARED

24. DATE CLEARED 031099

25. OFFENSE TYPE
1. ADULT NA
2. JUVENILE
3. UNKNOWN

39. (CODE S-SUSPECT W-WITNESS V-VICTIM O-OTHER)					42. ADDRESS	43. TELEPHONE
CODE	40. NAME-LAST	FIRST	MI	41. D.O.B.		

Registered owner - Swoboda, Terry M, dob [REDACTED], m/w, 510/175, Brwn/Brwn.

Manitowoc Police Officer 860 checked [REDACTED] S 21st St and [REDACTED] Division St at 15:49 hrs on 01-12-99 for vehicle. Vehicle was not at either residence, but will check again later this evening. #939/kj

1-21-99 Checked 10-28 does not match our discription

45. IF COMPLAINANT DIFFERENT THEN CALLER, ENTER NAME, ADDRESS, D.O.B., TELEPHONE.

46. IF CODE O (OTHER) IS USED IN FIELD #39, EXPLAIN.

INCIDENT REPORT: NOTE: IF SECTION 22 ABOVE HAS NUMBER 4 CHECKED, DO NOT GO BEYOND THIS LINE WITHOUT RECORDS SECTION BEING ADVISED, OR NO RECORD ENTRIES WILL BE MADE BELOW THIS LINE.

PROPERTY VALUE	26. PROPERTY	A. CURRENCY	B. JEWELRY	C. FURS CLOTHING	D. VEHICLE (LOCAL)	E. OFFICE EQUIPMENT	F. RADIO, TV CAMERAS	G. FIREARMS	H. HOUSE-HOLD GOODS
	STOLEN	\$	\$	\$	\$	\$	\$	\$	\$
	RECOVERED	\$	\$	\$	\$	\$	\$	\$	\$
	26. PROPERTY	I. CONSUMABLES	J. LIVESTOCK	K. DRUGS	L. MARINE ITEMS	M. CONSTRUCTION ITEMS	N. LAWN AND GARDEN	O. SPORTING GOODS	P. MISC BICYCLE
	STOLEN	\$	\$	\$	\$	\$	\$	\$	\$
	RECOVERED	\$	\$	\$	\$	\$	\$	\$	\$

27. PROPERTY RECOVERED: LOCALLY _____ OTHER JURISDICTION _____ (INSERT O OR L)

PROPERTY ITEMIZATION	PROPERTY STOLEN/RECOVERED ITEMIZATION, USE THE FOLLOWING FORMAT				
	28. QUANTITY	29. ARTICLE NAME	30. BRAND NAME	31. SERIAL NUMBER	32. CODE
					S <input type="checkbox"/> R <input type="checkbox"/>
					S <input type="checkbox"/> R <input type="checkbox"/>
					S <input type="checkbox"/> R <input type="checkbox"/>
					S <input type="checkbox"/> R <input type="checkbox"/>

33. PROPERTY DAMAGE AMOUNT \$ _____ 34. INSURANCE COMPANY _____

35. OFFICER ASSAULTED Y N 36. ARSON Y N 37. STRUCTURE CODE _____ 38. DAMAGE \$ _____

47. CIB ENTERED CANCELLED
 NCIC
 OTHER BROADCAST

48. TOTAL AMOUNT PROPERTY STOLEN \$ _____

49. TOTAL AMOUNT PROPERTY RECOVERED \$ _____

50. IS REPORT CONTINUED? YES NO

51. CAUTION INDICATORS, ATLS ETC.

52. DATA PROCESS INFORMATION:

COMPUTER ENTERED DATE 3/8/99

MICROFILM INDEXED INITIAL KS

IS CASE CLASSIFICATION CORRECT? Y N
 IF N HAS CORRECTION BEEN MADE? Y N

53. FILE APPROVAL

BY  DATE 03/08/99

INCIDENT CARD

577 000 70 163011, 11,4020

4. INCIDENT CS/S99-00242

5. INCIDENT LOCATION [REDACTED] CTH U

6. NAME - LAST - FIRST - MI 7. D.O.B.
Anonymous

8. ADDRESS 9. TX-HOME

11. CITY STATE ZIP 10. TX-BUSINESS

12. DETAILS
 Caller states Mark A. Vetter ([REDACTED]) Has many older trucks and also does vehicle repair work his brother is the same.

14. REC'D	15. DISP	16. 10-23	17. 10-24
13. DAY			
SUN 1	THU 5		
MON 2	FRI 6		
TUE 3	SAT 7		
(WED 4)			

18. ASSIGNED M. Bushman 494
MITSU 929

19. REC. BY 944 20. DIS. BY.

21. HOW REC'D.
 1. 911
 2. POLICE RADIO
 3. PHONE
 4. TTY
 5. IN PERSON
 6. ON VIEW
 7. OFF. OFF DUTY
 8. C.B. RADIO
 9. OTHER

22. TYPE OF REPORT
 1. INCIDENT
 2. ACCIDENT
 3. CITATION
 4. NONE

23. STATUS
 1. UNFOUNDED
 2. PNL
 3. OTHER
 4. CLEARED
 5. EXCEPT CLEARED

24. DATE CLEARED 01/12/99

25. OFFENSE TYPE
 1. ADULT NA
 2. JUVENILE
 3. UNKNOWN

39. (CODE S-SUSPECT W-WITNESS V-VICTIM O-OTHER)						
CODE	40. NAME- LAST	FIRST	MI	41. D.O.B.	42. ADDRESS	43. TELEPHONE
0	VETTER	MARK	A	[REDACTED]	[REDACTED] CTH U, Newton	

01/14/99 @ 1628 Hrs.: I, Lt. M. Bushman, attempted contact at [REDACTED] CTH U, but no one was home. An old Toyota pickup truck was noted to be standing in the yard.

01/14/99 @ 1945 Hrs.: A second attempt was made, and I was invited in to speak with MARK VETTER. VETTER currently owns an old Toyota pickup, a 1953 Chevrolet truck, 2 old Buicks, and an Isuzu Trooper--no Chevrolet trucks. He has not repaired any Chevrolet trucks recently either. VETTER was very cooperative. He is not a suspect at this time.

MJBushman /bjc

45. IF COMPLAINANT DIFFERENT THEN CALLER, ENTER NAME, ADDRESS, D.O.B., TELEPHONE.

46. IF CODE O (OTHER) IS USED IN FIELD #39, EXPLAIN.

INCIDENT REPORT: NOTE: IF SECTION 22 ABOVE HAS NUMBER 4 CHECKED, DO NOT GO BEYOND THIS LINE WITHOUT RECORDS SECTION BEING ADVISED, OR NO RECORD ENTRIES WILL BE MADE BELOW THIS LINE.

PROPERTY VALUE	26. PROPERTY	A. CURRENCY	B. JEWELRY	C. FURS CLOTHING	D. VEHICLE (LOCAL)	E. OFFICE EQUIPMENT	F. RADIO, TV CAMERAS	G. FIREARMS	H. HOUSE-HOLD GOODS
	STOLEN	\$	\$	\$	\$	\$	\$	\$	\$
	RECOVERED	\$	\$	\$	\$	\$	\$	\$	\$
	26. PROPERTY	I. CONSUMABLES	J. LIVESTOCK	K. DRUGS	L. MARINE ITEMS	M. CONSTRUCTION ITEMS	N. LAWN AND GARDEN	O. SPORTING GOODS	P. MISC BICYCLE
STOLEN	\$	\$	\$	\$	\$	\$	\$	\$	
RECOVERED	\$	\$	\$	\$	\$	\$	\$	\$	

27. PROPERTY RECOVERED: LOCALLY _____ OTHER JURISDICTION _____ (INSERT O OR L)

PROPERTY ITEMIZATION	PROPERTY STOLEN/RECOVERED ITEMIZATION, USE THE FOLLOWING FORMAT				
	28. QUANTITY	29. ARTICLE NAME	30. BRAND NAME	31. SERIAL NUMBER	32. CODE
					S R <input type="checkbox"/> <input type="checkbox"/>
					S R <input type="checkbox"/> <input type="checkbox"/>
					S R <input type="checkbox"/> <input type="checkbox"/>
					S R <input type="checkbox"/> <input type="checkbox"/>

33. PROPERTY DAMAGE AMOUNT \$ _____

34. INSURANCE COMPANY _____

35. OFFICER ASSAULTED Y N

36. ARSON Y N

37. STRUCTURE CODE _____

38. DAMAGE \$ _____

47. CIB ENTERED CANCELLED
 NCIC
 OTHER BROADCAST

48. TOTAL AMOUNT PROPERTY STOLEN \$ _____

49. TOTAL AMOUNT PROPERTY RECOVERED \$ _____

50. IS REPORT CONTINUED? YES NO

51. CAUTION INDICATORS, ATLS ETC.

52. DATA PROCESS INFORMATION:

COMPUTER ENTERED DATE

MICROFILM INDEXED INITIAL _____

IS CASE CLASSIFICATION CORRECT? Y N
 IF N HAS CORRECTION BEEN MADE? Y N

53. FILE APPROVAL

BY 

DATE

599 IN: 00040 16,510,11 11,410,02

4. INCIDENT
CS/599-00242

5. INCIDENT LOCATION
CTH CR

6. NAME - LAST - FIRST - MI
[REDACTED]

7. D.O.B.
[REDACTED]

8. ADDRESS
[REDACTED]

9. TX-HOME
[REDACTED]

10. BUSINESS
[REDACTED]

11. CITY STATE ZIP

12. DETAILS
SOLD A 1988 CHEV BLAZER,
FULL SIZE, BLACK IN COLOR, TD
JESSE VETTING OF NEWTON COUPLE
MONTHS AGO.

INCIDENT CARD

18. ASSIGNED
MTSO 91219
Bushman 4411

19. REC. BY
932

20. DIS. BY
932

22. TYPE OF REPORT
① INCIDENT
2. ACCIDENT
3. CITATION
4. NONE

21. HOW REC'D.
1. 911
2. POLICE RADIO
③ 3. PHONE
4. TTY
5. IN PERSON
6. ON VIEW
7. OFF. OFF DUTY
8. C.B. RADIO
9. OTHER

23. STATUS
1. UNFOUNDED
2. PNL
③ 3. OTHER
4. CLEARED
5. EXCEPT CLEARED

24. DATE
CLEARED 11/9/99

25. OFFENSE TYPE
1. ADULT NA
2. JUVENILE
3. UNKNOWN

14. REC'D	15. DISP	16. 10-23	17. 10-24
13. DAY			
SUN 1	THU 5		
MON 2	FRI 6		
TUE ③	SAT 7		
WED 4			

39. (CODE S-SUSPECT W-WITNESS V-VICTIM O-OTHER)						
CODE	40. NAME-LAST	FIRST	MI	41. D.O.B.	42. ADDRESS	43. TELEPHONE

An RHAS check on VETTING through State Patrol produced a 1989 GMC bearing WI RP# TLK-249. 932/mh
Description does not match.M.J.Bushman

45. IF COMPLAINANT DIFFERENT THEN CALLER, ENTER NAME, ADDRESS, D.O.B., TELEPHONE.

46. IF CODE O (OTHER) IS USED IN FIELD #39, EXPLAIN.

INCIDENT REPORT: NOTE: IF SECTION 22 ABOVE HAS NUMBER 4 CHECKED, DO NOT GO BEYOND THIS LINE WITHOUT RECORDS SECTION BEING ADVISED, OR NO RECORD ENTRIES WILL BE MADE BELOW THIS LINE.

PROPERTY VALUE	26. PROPERTY	A. CURRENCY	B. JEWELRY	C. FURS CLOTHING	D. VEHICLE (LOCAL)	E. OFFICE EQUIPMENT	F. RADIO, TV CAMERAS	G. FIREARMS	H. HOUSE-HOLD GOODS
	STOLEN	\$	\$	\$	\$	\$	\$	\$	\$
	RECOVERED	\$	\$	\$	\$	\$	\$	\$	\$
	26. PROPERTY	I. CONSUMABLES	J. LIVESTOCK	K. DRUGS	L. MARINE ITEMS	M. CONSTRUCTION ITEMS	N. LAWN AND GARDEN	O. SPORTING GOODS	P. MISC BICYCLE
	STOLEN	\$	\$	\$	\$	\$	\$	\$	\$
	RECOVERED	\$	\$	\$	\$	\$	\$	\$	\$

27. PROPERTY RECOVERED: LOCALLY _____ OTHER JURISDICTION _____ (INSERT O OR L)

PROPERTY ITEMIZATION	PROPERTY STOLEN/RECOVERED ITEMIZATION, USE THE FOLLOWING FORMAT				
	28. QUANTITY	29. ARTICLE NAME	30. BRAND NAME	31. SERIAL NUMBER	32. CODE
					S R <input type="checkbox"/> <input type="checkbox"/>
					S R <input type="checkbox"/> <input type="checkbox"/>
					S R <input type="checkbox"/> <input type="checkbox"/>
					S R <input type="checkbox"/> <input type="checkbox"/>

33. PROPERTY DAMAGE AMOUNT \$ _____

34. INSURANCE COMPANY _____

35. OFFICER ASSAULTED Y N

36. ARSON Y N

37. STRUCTURE CODE _____

38. DAMAGE \$ _____

47. CIB ENTERED CANCELLED
 NCIC
 OTHER BROADCAST

48. TOTAL AMOUNT PROPERTY STOLEN \$ _____

49. TOTAL AMOUNT PROPERTY RECOVERED \$ _____

50. IS REPORT CONTINUED? YES NO

51. CAUTION INDICATORS, ATLS ETC.

52. DATA PROCESS INFORMATION:

COMPUTER ENTERED DATE 01/20/99
 MICROFILM INDEXED INITIAL KS

53. FILE APPROVAL

IS CASE CLASSIFICATION CORRECT? N
 IF N HAS CORRECTION BEEN MADE? N

BY  DATE 01/18/99

399 INL 00234 (2411) 01000

4. INCIDENT
CS / 599-00242

5. INCIDENT LOCATION
4300 Block Broadway

6. NAME - LAST - FIRST - MI
Anon.

7. D.O.B.

8. ADDRESS

9. TX-HOME

11. CITY STATE ZIP

10. TX-BUSINESS

12. DETAILS
Grey pickup parked across from [redacted] Broadway, Rt Tom Kohlbeck resi has grill out and passenger side headlight (rim) damage. Vehicle belongs to boyfriend of Kohlbeck's

14. REC'D.	15. DISP.	16. 10-23	17. 10-24
13. DAY			
SUN 1	THU 5		
MON 2	FRI 6		
TUE 3	SAT 7		
WED 4			

INCIDENT CARD

18. ASSIGNED
Tackes 498
Bushman 441

19. REC. BY
930

20. DIS. BY

21. HOW REC'D.
1. 911
2. POLICE RADIO
3. PHONE
4. TTY
5. IN PERSON
6. ON VIEW
7. OFF. OFF DUTY
8. C.B. RADIO
9. OTHER

22. TYPE OF REPORT
1. INCIDENT
2. ACCIDENT
3. CITATION
4. NONE

23. STATUS
1. UNFOUNDED
2. PNL
3. OTHER
4. CLEARED
5. EXCEPT CLEARED

24. DATE CLEARED
10/13/99

25. OFFENSE TYPE
1. ADULT NA
2. JUVENILE
3. UNKNOWN

39. (CODE S-SUSPECT W-WITNESS V-VICTIM O-OTHER)

CODE	40. NAME- LAST	FIRST	41. D.O.B.	42. ADDRESS	43. TELEPHONE
	Uetting, Jesse			[redacted] Pt. Creek Rd, Newton	

01-11-98 daughter and does not live there. Caller unable to obtain vehicle's registration. Caller wishes to remain anonymous and wasn't interested in reward part of Crimestopper program. sbraun920

Off. Tackes checked the vehicle and the damage was not consistent with the damage we're looking for in the fatal vehicle. M.J. Bushman

NOT FOR PRESS RELEASE

45. IF COMPLAINANT DIFFERENT THEN CALLER, ENTER NAME, ADDRESS, D.O.B., TELEPHONE.

46. IF CODE O (OTHER) IS USED IN FIELD #39, EXPLAIN.

INCIDENT REPORT: NOTE: IF SECTION 22 ABOVE HAS NUMBER 4 CHECKED, DO NOT GO BEYOND THIS LINE WITHOUT RECORDS SECTION BEING ADVISED, OR NO RECORD ENTRIES WILL BE MADE BELOW THIS LINE.

PROPERTY VALUE	26. PROPERTY	A. CURRENCY	B. JEWELRY	C. FURS CLOTHING	D. VEHICLE (LOCAL)	E. OFFICE EQUIPMENT	F. RADIO, TV CAMERAS	G. FIREARMS	H. HOUSE-HOLD GOODS
	STOLEN	\$	\$	\$	\$	\$	\$	\$	\$
	RECOVERED	\$	\$	\$	\$	\$	\$	\$	\$
	26. PROPERTY	I. CONSUMABLES	J. LIVESTOCK	K. DRUGS	L. MARINE ITEMS	M. CONSTRUCTION ITEMS	N. LAWN AND GARDEN	O. SPORTING GOODS	P. MISC BICYCLE
STOLEN	\$	\$	\$	\$	\$	\$	\$	\$	
RECOVERED	\$	\$	\$	\$	\$	\$	\$	\$	

27. PROPERTY RECOVERED: LOCALLY _____ OTHER JURISDICTION _____ (INSERT O OR L)

PROPERTY ITEMIZATION	PROPERTY STOLEN/RECOVERED ITEMIZATION, USE THE FOLLOWING FORMAT				
	28. QUANTITY	29. ARTICLE NAME	30. BRAND NAME	31. SERIAL NUMBER	32. CODE
					S R <input type="checkbox"/> <input type="checkbox"/>
					S R <input type="checkbox"/> <input type="checkbox"/>
					S R <input type="checkbox"/> <input type="checkbox"/>
					S R <input type="checkbox"/> <input type="checkbox"/>

33. PROPERTY DAMAGE AMOUNT \$ _____

34. INSURANCE COMPANY _____

35. OFFICER ASSAULTED Y N

36. ARSON Y N

37. STRUCTURE CODE _____ 38. DAMAGE \$ _____

47. CIB ENTERED CANCELLED
 NCIC
 OTHER BROADCAST

48. TOTAL AMOUNT PROPERTY STOLEN \$ _____

49. TOTAL AMOUNT PROPERTY RECOVERED \$ _____

50. IS REPORT CONTINUED? YES NO

51. CAUTION INDICATORS, ATLS ETC.

52. DATA PROCESS INFORMATION:

COMPUTER ENTERED DATE 01/15/99
 MICROFILM INDEXED INITIAL KS

53. FILE APPROVAL

IS CASE CLASSIFICATION CORRECT? Y N
 IF N HAS CORRECTION BEEN MADE? Y N

BY _____ DATE

INCIDENT CARD

399 11- 00200 10.30.11 . 1 10000

4. INCIDENT CS/599-00242

5. INCIDENT LOCATION

6. NAME - LAST - FIRST - MI ANONYMOUS (2) 7. D.O.B.

8. ADDRESS [REDACTED] 9. TX HOME [REDACTED]

11. CITY STATE ZIP 10. TX-BUSINESS

12. DETAILS
Caller states there was a "big party" on Hwy C - the Richard P. Bouril Residence 18224 last night on Hwy C.

18. ASSIGNED MTSO - CRIMESTOP 929

19. REC. BY 945 20. DIS. BY

22. TYPE OF REPORT
 INCIDENT
 ACCIDENT
 CITATION
 NONE

21. HOW REC'D.
 1. 911
 2. POLICE RADIO
 3. PHONE
 4. TTY
 5. IN PERSON
 6. ON VIEW
 7. OFF. OFF DUTY
 8. C.B. RADIO
 9. OTHER

23. STATUS
 1. UNFOUNDED
 2. PNL
 3. OTHER
 4. CLEARED
 5. EXCEPT CLEARED

24. DATE CLEARED 01/11/99

25. OFFENSE TYPE
 1. ADULT NA
 2. JUVENILE
 3. UNKNOWN

14. REC'D	15. DISP	16. 10-23	17. 10-24
13. DAY			
SUN 1 THU 5			
MON 2 FRI 6			
TUE 3 SAT 7			
WED 4			

39. (CODE S-SUSPECT W-WITNESS V-VICTIM O-OTHER)

CODE	40. NAME - LAST	FIRST	MI	41. D.O.B.	42. ADDRESS	43. TELEPHONE

45. IF COMPLAINANT DIFFERENT THEN CALLER, ENTER NAME, ADDRESS, D.O.B., TELEPHONE.

46. IF CODE O (OTHER) IS USED IN FIELD #39, EXPLAIN.

INCIDENT REPORT: NOTE: IF SECTION 22 ABOVE HAS NUMBER 4 CHECKED, DO NOT GO BEYOND THIS LINE WITHOUT RECORDS SECTION BEING ADVISED, OR NO RECORD ENTRIES WILL BE MADE BELOW THIS LINE.

PROPERTY VALUE	26. PROPERTY	A. CURRENCY	B. JEWELRY	C. FURS CLOTHING	D. VEHICLE (LOCAL)	E. OFFICE EQUIPMENT	F. RADIO, TV CAMERAS	G. FIREARMS	H. HOUSE-HOLD GOODS
	STOLEN	\$	\$	\$	\$	\$	\$	\$	\$
	RECOVERED	\$	\$	\$	\$	\$	\$	\$	\$
	26. PROPERTY	I. CONSUMABLES	J. LIVESTOCK	K. DRUGS	L. MARINE ITEMS	M. CONSTRUCTION ITEMS	N. LAWN AND GARDEN	O. SPORTING GOODS	P. MISC BICYCLE
	STOLEN	\$	\$	\$	\$	\$	\$	\$	\$
	RECOVERED	\$	\$	\$	\$	\$	\$	\$	\$

27. PROPERTY RECOVERED: LOCALLY _____ OTHER JURISDICTION _____ (INSERT O OR L)

PROPERTY ITEMIZATION	PROPERTY STOLEN/RECOVERED ITEMIZATION, USE THE FOLLOWING FORMAT				
	28. QUANTITY	29. ARTICLE NAME	30. BRAND NAME	31. SERIAL NUMBER	32. CODE
					S <input type="checkbox"/> R <input type="checkbox"/>
					S <input type="checkbox"/> R <input type="checkbox"/>
					S <input type="checkbox"/> R <input type="checkbox"/>
					S <input type="checkbox"/> R <input type="checkbox"/>

33. PROPERTY DAMAGE AMOUNT \$ _____ 34. INSURANCE COMPANY _____

35. OFFICER ASSAULTED Y N 36. ARSON Y N 37. STRUCTURE CODE _____ 38. DAMAGE \$ _____

47. CIB	ENTERED <input type="checkbox"/>	CANCELLED <input type="checkbox"/>	48. TOTAL AMOUNT PROPERTY STOLEN \$ _____
NCIC	<input type="checkbox"/>	<input type="checkbox"/>	
OTHER BROADCAST	<input type="checkbox"/>	<input type="checkbox"/>	49. TOTAL AMOUNT PROPERTY RECOVERED \$ _____

50. IS REPORT CONTINUED? YES NO 51. CAUTION INDICATORS, ATLS ETC.

52. DATA PROCESS INFORMATION:

COMPUTER ENTERED DATE 01/12/99

MICROFILM INDEXED INITIAL KS

IS CASE CLASSIFICATION CORRECT? IF N HAS CORRECTION BEEN MADE? Y N

53. FILE APPROVAL

BY [Signature] DATE 01/11/99

MCSO 028 1/91

599 IN 00210 162111 199400

4. INCIDENT
OS / Fatal HR

5. INCIDENT LOCATION

6. NAME LAST FIRST MI
[REDACTED] 938 [REDACTED]

7. D.O.B. [REDACTED]

8. ADDRESS [REDACTED]

9. TX-HOME [REDACTED]

10. TX-BUSINESS [REDACTED]

11. CITY [REDACTED] ZIP [REDACTED]

12. DETAILS
Reports seeing a vintage gray Chev P.U. truck on 1-10-99 around 2:30am. Was seen driving SB on S Union Rd by Hwy 42 garage turned on 42 back to Manitowoc. [REDACTED] is a Lakeshore Chronicle delivery driver.

INCIDENT CARD

18. ASSIGNED
MISO 929

19. REC. BY
935

20. DIS. BY
935

21. HOW REC'D.
1. 911
2. POLICE RADIO
3. PHONE
4. TTY
5. IN PERSON
6. ON VIEW
7. OFF. OFF DUTY
8. C.B. RADIO
9. OTHER

22. TYPE OF REPORT
1. INCIDENT
2. ACCIDENT
3. CITATION
4. NONE

23. STATUS
1. UNFOUNDED
2. PNL
3. OTHER
4. CLEARED
5. EXCEPT CLEARED

24. DATE CLEARED
01/13/99

25. OFFENSE TYPE
1. ADULT NA
2. JUVENILE
3. UNKNOWN

14. REC'D	15. DISP	16. 10-23	17. 10-24
13. DAY			
SUN 1	THU 5		
MON 2	FRI 6		
TUE 3	SAT 7		
WED 4			

39. (CODE S-SUSPECT W-WITNESS V-VICTIM O-OTHER)						
CODE	40. NAME-LAST	FIRST	MI	41. D.O.B.	42. ADDRESS	43. TELEPHONE

01/11/98 I, Lt. Bushman, did contact [REDACTED] by phone. He is a newspaper carrier who is out and about the activity he witnessed was unusual. The vehicle did not match M.J. Bushman.

45. IF COMPLAINANT DIFFERENT THEN CALLER, ENTER NAME, ADDRESS, D.O.B., TELEPHONE.

46. IF CODE O (OTHER) IS USED IN FIELD #39, EXPLAIN.

INCIDENT REPORT: NOTE: IF SECTION 22 ABOVE HAS NUMBER 4 CHECKED, DO NOT GO BEYOND THIS LINE WITHOUT RECORDS SECTION BEING ADVISED, OR NO RECORD ENTRIES WILL BE MADE BELOW THIS LINE.

PROPERTY VALUE	26. PROPERTY	A. CURRENCY	B. JEWELRY	C. FURS CLOTHING	D. VEHICLE (LOCAL)	E. OFFICE EQUIPMENT	F. RADIO, TV CAMERAS	G. FIREARMS	H. HOUSE-HOLD GOODS
	STOLEN	\$	\$	\$	\$	\$	\$	\$	\$
	RECOVERED	\$	\$	\$	\$	\$	\$	\$	\$
	26. PROPERTY	I. CONSUMABLES	J. LIVESTOCK	K. DRUGS	L. MARINE ITEMS	M. CONSTRUCTION ITEMS	N. LAWN AND GARDEN	O. SPORTING GOODS	P. MISC BICYCLE
	STOLEN	\$	\$	\$	\$	\$	\$	\$	\$
	RECOVERED	\$	\$	\$	\$	\$	\$	\$	\$

27. PROPERTY RECOVERED: LOCALLY _____ OTHER JURISDICTION _____ (INSERT O OR L)

PROPERTY ITEMIZATION	PROPERTY STOLEN/RECOVERED ITEMIZATION, USE THE FOLLOWING FORMAT				
	28. QUANTITY	29. ARTICLE NAME	30. BRAND NAME	31. SERIAL NUMBER	32. CODE
					S R <input type="checkbox"/> <input type="checkbox"/>
					S R <input type="checkbox"/> <input type="checkbox"/>
					S R <input type="checkbox"/> <input type="checkbox"/>
					S R <input type="checkbox"/> <input type="checkbox"/>
					S R <input type="checkbox"/> <input type="checkbox"/>

33. PROPERTY DAMAGE AMOUNT \$ _____

34. INSURANCE COMPANY _____

35. OFFICER ASSAULTED Y N

36. ARSON Y N

37. STRUCTURE CODE _____

38. DAMAGE \$ _____

47. CIB ENTERED CANCELLED
 NCIC
 OTHER BROADCAST

48. TOTAL AMOUNT PROPERTY STOLEN \$ _____

49. TOTAL AMOUNT PROPERTY RECOVERED \$ _____

50. IS REPORT CONTINUED? YES NO

51. CAUTION INDICATORS, ATLS ETC.

52. DATA PROCESS INFORMATION:

COMPUTER ENTERED DATE 10/12/99
 MICROFILM INDEXED INITIAL SS

53. FILE APPROVAL

BY WRB DATE 10/30/99

IS CASE CLASSIFICATION CORRECT?
 IF N HAS CORRECTION BEEN MADE? Y N

000 14 00200 11021011 12131000

4. INCIDENT **CS / Fatal H&R**

5. INCIDENT LOCATION
18th St

6. NAME - LAST-FIRST-MI
[REDACTED] MI

7. D.O.B.
[REDACTED]

8. ADDRESS
[REDACTED]

9. TX-HOME
[REDACTED]

10. TX-BUSINESS
[REDACTED]

11. CITY STATE ZIP
[REDACTED]

12. DETAILS
 reports seeing a blue P.U. truck
 with Right head light out in
 parking lot at Hamilton. Did not
 have an RP. Was parked at the

170
01/11/99

14. REC'D
15. DISP
16. 10-23
17. 10-24

13. DAY
 SUN 1 THU 5
 MON 2 FRI 6
 TUE 3 SAT 7
 WED 4

INCIDENT CARD

18. ASSIGNED
1150 **91219**

19. REC. BY
935

20. DIS. BY

21. HOW REC'D.
 1. 911
 2. POLICE RADIO
 3. PHONE
 4. TTY
 5. IN PERSON
 6. ON VIEW
 7. OFF. OFF DUTY
 8. C.B. RADIO
 9. OTHER
 21A. M.O.

22. TYPE OF REPORT
 1. INCIDENT
 2. ACCIDENT
 3. CITATION
 4. NONE

23. STATUS
 1. UNFOUNDED
 2. PNL
 3. OTHER
 4. CLEARED
 5. EXCEPT CLEARED

24. DATE CLEARED
01/11/99

25. OFFENSE TYPE
 1. ADULT NA
 2. JUVENILE
 3. UNKNOWN

39. (CODE S-SUSPECT W-WITNESS V-VICTIM O-OTHER)					42. ADDRESS		43. TELEPHONE
CODE	40. NAME-LAST	FIRST	MI	41. D.O.B.			

UP pickup in the employees lot off of 19th st. 935/lms

01/11/99 Vehicle was no longer there and no registration obtained. TRPD is aware and will watch for it tomorrow. They will check for RP and damage. M.J. Bushman

MJB

45. IF COMPLAINANT DIFFERENT THEN CALLER, ENTER NAME, ADDRESS, D.O.B., TELEPHONE.

46. IF CODE O (OTHER) IS USED IN FIELD #39, EXPLAIN.

INCIDENT REPORT: NOTE: IF SECTION 22 ABOVE HAS NUMBER 4 CHECKED, DO NOT GO BEYOND THIS LINE WITHOUT RECORDS SECTION BEING ADVISED, OR NO RECORD ENTRIES WILL BE MADE BELOW THIS LINE.

PROPERTY VALUE	26. PROPERTY	A. CURRENCY	B. JEWELRY	C. FURS CLOTHING	D. VEHICLE (LOCAL)	E. OFFICE EQUIPMENT	F. RADIO, TV CAMERAS	G. FIREARMS	H. HOUSE-HOLD GOODS
	STOLEN	\$	\$	\$	\$	\$	\$	\$	\$
	RECOVERED	\$	\$	\$	\$	\$	\$	\$	\$
	26. PROPERTY	I. CONSUM-ABLES	J. LIVESTOCK	K. DRUGS	L. MARINE ITEMS	M. CONSTRUCTION ITEMS	N. LAWN AND GARDEN	O. SPORTING GOODS	P. MISC BICYCLE
	STOLEN	\$	\$	\$	\$	\$	\$	\$	\$
	RECOVERED	\$	\$	\$	\$	\$	\$	\$	\$

27. PROPERTY RECOVERED: LOCALLY _____ OTHER JURISDICTION _____ (INSERT O OR L)

PROPERTY ITEMIZATION	PROPERTY STOLEN/RECOVERED ITEMIZATION, USE THE FOLLOWING FORMAT				
	28. QUANTITY	29. ARTICLE NAME	30. BRAND NAME	31. SERIAL NUMBER	32. CODE
					S R <input type="checkbox"/> <input type="checkbox"/>
					S R <input type="checkbox"/> <input type="checkbox"/>
					S R <input type="checkbox"/> <input type="checkbox"/>
					S R <input type="checkbox"/> <input type="checkbox"/>
					S R <input type="checkbox"/> <input type="checkbox"/>

33. PROPERTY DAMAGE AMOUNT \$ _____ 34. INSURANCE COMPANY _____

35. OFFICER ASSAULTED Y N 36. ARSON Y N 37. STRUCTURE CODE _____ 38. DAMAGE \$ _____

47. CIB	ENTERED <input type="checkbox"/>	CANCELLED <input type="checkbox"/>	48. TOTAL AMOUNT PROPERTY STOLEN \$ _____
NCIC	<input type="checkbox"/>	<input type="checkbox"/>	
OTHER BROADCAST	<input type="checkbox"/>	<input type="checkbox"/>	
			49. TOTAL AMOUNT PROPERTY RECOVERED \$ _____

50. IS REPORT CONTINUED? YES NO 51. CAUTION INDICATORS, ATLS ETC.

52. DATA PROCESS INFORMATION:

COMPUTER ENTERED DATE 01/12/99

MICROFILM INDEXED INITIAL KS

IS CASE CLASSIFICATION CORRECT? IF N HAS CORRECTION BEEN MADE? Y N

53. FILE APPROVAL BY WLB DATE 01/12/99

399 172 00200 10.510.11 15.4100.4

4. INCIDENT: CS/899-00242

5. INCIDENT LOCATION: CTH CL

6. NAME-LAST-FIRST-MI: ANONYMOUS (7) 7. D.O.B.

8. ADDRESS 9. TX-HOME

11. CITY STATE ZIP 10. TX-BUSINESS

12. DETAILS: PARTY LAST NAME ZIARNIK, LIVES ON NW CORNER CLOVER RD - GASS LAKE RD HAS TRK THAT MATCHES DESC OF SUSPECT VEH.

14. REC'D 15. DISP 16. 10-23 17. 10-24

13. DAY: SUN 1 THU 5, MON (2) FRI 6, TUE 3 SAT 7, WED 4

INCIDENT CARD

18. ASSIGNED: MTSO 9/2/99

19. REC. BY: 932 20. DIS. BY: -

21. HOW REC'D: 1. 911, 2. POLICE RADIO, 3. PHONE (checked), 4. TTY, 5. IN PERSON, 6. ON VIEW, 7. OFF. OFF DUTY, 8. C.B. RADIO, 9. OTHER

22. TYPE OF REPORT: 1. INCIDENT (checked), 2. ACCIDENT, 3. CITATION, 4. NONE

23. STATUS: 1. UNFOUNDED, 2. PNL, 3. OTHER (checked), 4. CLEARED, 5. EXCEPT CLEARED

24. DATE CLEARED: 01/29/99

25. OFFENSE TYPE: 1. ADULT NA , 2. JUVENILE , 3. UNKNOWN

39. (CODE S-SUSPECT W-WITNESS V-VICTIM O-OTHER)						
CODE	40. NAME-LAST	FIRST	MI	41. D.O.B.	42. ADDRESS	43. TELEPHONE

Information passed on to Lt. Bushman who had already seen the truck and advised it has been disabled for past week and saw it earlier today at All Car Automotive and then at Steffen's for repairs. 932/mh

01/11/99 I checked this vehicle out, it has been out of service, not running since Tuesday 01/05/99. M.J. Bushman *MJB*

45. IF COMPLAINANT DIFFERENT THEN CALLER, ENTER NAME, ADDRESS, D.O.B., TELEPHONE.

46. IF CODE O (OTHER) IS USED IN FIELD #39, EXPLAIN.

INCIDENT REPORT: NOTE: IF SECTION 22 ABOVE HAS NUMBER 4 CHECKED, DO NOT GO BEYOND THIS LINE WITHOUT RECORDS SECTION BEING ADVISED, OR NO RECORD ENTRIES WILL BE MADE BELOW THIS LINE.

PROPERTY VALUE	26. PROPERTY	A. CURRENCY	B. JEWELRY	C. FURS CLOTHING	D. VEHICLE (LOCAL)	E. OFFICE EQUIPMENT	F. RADIO, TV CAMERAS	G. FIREARMS	H. HOUSE-HOLD GOODS
	STOLEN	\$	\$	\$	\$	\$	\$	\$	\$
	RECOVERED	\$	\$	\$	\$	\$	\$	\$	\$
	26. PROPERTY	I. CONSUMABLES	J. LIVESTOCK	K. DRUGS	L. MARINE ITEMS	M. CONSTRUCTION ITEMS	N. LAWN AND GARDEN	O. SPORTING GOODS	P. MISC BICYCLE
	STOLEN	\$	\$	\$	\$	\$	\$	\$	\$
	RECOVERED	\$	\$	\$	\$	\$	\$	\$	\$

27. PROPERTY RECOVERED: LOCALLY ____ OTHER JURISDICTION ____ (INSERT O OR L)

PROPERTY ITEMIZATION	PROPERTY STOLEN/RECOVERED ITEMIZATION, USE THE FOLLOWING FORMAT				
	28. QUANTITY	29. ARTICLE NAME	30. BRAND NAME	31. SERIAL NUMBER	32. CODE
					S R <input type="checkbox"/> <input type="checkbox"/>
					S R <input type="checkbox"/> <input type="checkbox"/>
					S R <input type="checkbox"/> <input type="checkbox"/>
					S R <input type="checkbox"/> <input type="checkbox"/>

33. PROPERTY DAMAGE AMOUNT \$ _____

34. INSURANCE COMPANY _____

35. OFFICER ASSAULTED Y N

36. ARSON Y N

37. STRUCTURE CODE _____ 38. DAMAGE \$ _____

47. CIB ENTERED CANCELLED
 NCIC
 OTHER BROADCAST

48. TOTAL AMOUNT PROPERTY STOLEN \$ _____

49. TOTAL AMOUNT PROPERTY RECOVERED \$ _____

50. IS REPORT CONTINUED? YES NO

51. CAUTION INDICATORS, ATLS ETC.

52. DATA PROCESS INFORMATION:

COMPUTER ENTERED DATE 10/12/99
 MICROFILM INDEXED INITIAL KS

IS CASE CLASSIFICATION CORRECT? N
 IF N HAS CORRECTION BEEN MADE? N

53. FILE APPROVAL

BY WRB DATE 10/12/99

399 IV- 00207 10,510,11 10000

4. INCIDENT
CS / Fatal IHR

5. INCIDENT LOCATION
Brillion Subway

6. NAME - LAST - FIRST MI
[REDACTED] 1500

7. D.O.B.
[REDACTED]

8. ADDRESS
[REDACTED]

9. TX-HOME
[REDACTED]

10. TX-BUSINESS
[REDACTED]

11. CITY STATE ZIP
[REDACTED]

12. DETAILS
2 kids came into subway today Betw 4p - 4:30p. They came out of a red Pont with a damaged gray grill RP SNV977

INCIDENT CARD

18. ASSIGNED
MISO 929

19. REC. BY
935

20. DIS. BY

21. HOW REC'D.
1. 911
2. POLICE RADIO
3. PHONE
4. TTY
5. IN PERSON
6. ON VIEW
7. OFF. OFF DUTY
8. C.B. RADIO
9. OTHER

22. TYPE OF REPORT
1. INCIDENT
2. ACCIDENT
3. CITATION
4. NONE

23. STATUS
1. UNFOUNDED
2. PNL
3. OTHER
4. CLEARED
5. EXCEPT CLEARED

24. DATE CLEARED
10/12/99

25. OFFENSE TYPE
1. ADULT NA
2. JUVENILE
3. UNKNOWN

14. REC'D
15. DISP
16. 10-23
17. 10-24

13. DAY
SUN 1 THU 5
MON 2 FRI 6
TUE 3 SAT 7
WED 4

39. (CODE S-SUSPECT W-WITNESS V-VICTIM O-OTHER)

CODE	40. NAME-LAST	FIRST	MI	41. D.O.B.	42. ADDRESS	43. TELEPHONE

01/11/99 Vehicle does not match suspect vehicle. M.J. Bushman

45. IF COMPLAINANT DIFFERENT THEN CALLER, ENTER NAME, ADDRESS, D.O.B., TELEPHONE.

46. IF CODE O (OTHER) IS USED IN FIELD #39, EXPLAIN.

INCIDENT REPORT: NOTE: IF SECTION 22 ABOVE HAS NUMBER 4 CHECKED, DO NOT GO BEYOND THIS LINE WITHOUT RECORDS SECTION BEING ADVISED, OR NO RECORD ENTRIES WILL BE MADE BELOW THIS LINE.

PROPERTY VALUE	26. PROPERTY	A. CURRENCY	B. JEWELRY	C. FURS CLOTHING	D. VEHICLE (LOCAL)	E. OFFICE EQUIPMENT	F. RADIO, TV CAMERAS	G. FIREARMS	H. HOUSE-HOLD GOODS
	STOLEN	\$	\$	\$	\$	\$	\$	\$	\$
	RECOVERED	\$	\$	\$	\$	\$	\$	\$	\$
	26. PROPERTY	I. CONSUM-ABLES	J. LIVESTOCK	K. DRUGS	L. MARINE ITEMS	M. CONSTRUCTION ITEMS	N. LAWN AND GARDEN	O. SPORTING GOODS	P. MISC BICYCLE
	STOLEN	\$	\$	\$	\$	\$	\$	\$	\$
	RECOVERED	\$	\$	\$	\$	\$	\$	\$	\$

27. PROPERTY RECOVERED: LOCALLY ____ OTHER JURISDICTION ____ (INSERT O OR L)

PROPERTY ITEMIZATION	PROPERTY STOLEN/RECOVERED ITEMIZATION, USE THE FOLLOWING FORMAT				
	28. QUANTITY	29. ARTICLE NAME	30. BRAND NAME	31. SERIAL NUMBER	32. CODE
					S R <input type="checkbox"/> <input type="checkbox"/>
					S R <input type="checkbox"/> <input type="checkbox"/>
					S R <input type="checkbox"/> <input type="checkbox"/>
					S R <input type="checkbox"/> <input type="checkbox"/>

33. PROPERTY DAMAGE AMOUNT \$ _____

34. INSURANCE COMPANY _____

35. OFFICER ASSAULTED Y N

36. ARSON Y N

37. STRUCTURE CODE _____ 38. DAMAGE \$ _____

47. CIB ENTERED CANCELLED
 NCIC
 OTHER BROADCAST

48. TOTAL AMOUNT PROPERTY STOLEN \$ _____

49. TOTAL AMOUNT PROPERTY RECOVERED \$ _____

50. IS REPORT CONTINUED? YES NO

51. CAUTION INDICATORS, ATLS ETC.

52. DATA PROCESS INFORMATION:

COMPUTER ENTERED DATE 01/12/99
 MICROFILM INDEXED INITIAL KS

53. FILE APPROVAL

BY KP DATE 01/12/99

IS CASE CLASSIFICATION CORRECT? N
 IF N HAS CORRECTION BEEN MADE? Y N

1011111 121000

4. INCIDENT **CS/599-00242**

5. INCIDENT LOCATION

6. NAME - LAST - FIRST - MI **ANONYMOUS (2)** 7. D.O.B.

8. ADDRESS 9. TX-HOME

11. CITY STATE ZIP 10. TX-BUSINESS

12. DETAILS
Caller states she saw a car w/ a wreath covering front (R) grill/fender damage. Plate # TKL-895

INCIDENT CARD

18. ASSIGNED **MTSO** 92

19. REC. BY **945** 20. DIS. BY **-**

22. TYPE OF REPORT
 INCIDENT
 ACCIDENT
 CITATION
 NONE

21. HOW REC'D.
 1. 911
 2. POLICE RADIO
 3. PHONE
 4. TTY
 5. IN PERSON
 6. ON VIEW
 7. OFF, OFF DUTY
 8. C.B. RADIO
 9. OTHER **CS**

23. STATUS
 1. UNFOUNDED
 PNL
 OTHER
 CLEARED
 EXCEPT CLEARED

24. DATE CLEARED **10/08/99**

25. OFFENSE TYPE
 1. ADULT NA
 2. JUVENILE
 3. UNKNOWN

14. REC'D	15. DISP	16. 10-23	17. 10-24
13. DAY			
SUN 1	THU 5		
MON 2	FRI 6		
TUE 3	SAT 7		
WED 4			

39. (CODE S-SUSPECT W-WITNESS V-VICTIM O-OTHER)

CODE	40. NAME - LAST	FIRST	MI	41. D.O.B.	42. ADDRESS	43. TELEPHONE

vehicle does not match what we are looking for *SA*

45. IF COMPLAINANT DIFFERENT THEN CALLER, ENTER NAME, ADDRESS, D.O.B., TELEPHONE.

46. IF CODE O (OTHER) IS USED IN FIELD #39, EXPLAIN.

INCIDENT REPORT: NOTE: IF SECTION 22 ABOVE HAS NUMBER 4 CHECKED, DO NOT GO BEYOND THIS LINE WITHOUT RECORDS SECTION BEING ADVISED, OR NO RECORD ENTRIES WILL BE MADE BELOW THIS LINE.

PROPERTY VALUE	26. PROPERTY	A. CURRENCY	B. JEWELRY	C. FURS CLOTHING	D. VEHICLE (LOCAL)	E. OFFICE EQUIPMENT	F. RADIO, TV CAMERAS	G. FIREARMS	H. HOUSE-HOLD GOODS
	STOLEN	\$	\$	\$	\$	\$	\$	\$	\$
	RECOVERED	\$	\$	\$	\$	\$	\$	\$	\$
	26. PROPERTY	I. CONSUM-ABLES	J. LIVESTOCK	K. DRUGS	L. MARINE ITEMS	M. CONSTRUCTION ITEMS	N. LAWN AND GARDEN	O. SPORTING GOODS	P. MISC BICYCLE
	STOLEN	\$	\$	\$	\$	\$	\$	\$	\$
	RECOVERED	\$	\$	\$	\$	\$	\$	\$	\$

27. PROPERTY RECOVERED: LOCALLY _____ OTHER JURISDICTION _____ (INSERT O OR L)

PROPERTY ITEMIZATION	PROPERTY STOLEN/RECOVERED ITEMIZATION, USE THE FOLLOWING FORMAT				
	28. QUANTITY	29. ARTICLE NAME	30. BRAND NAME	31. SERIAL NUMBER	32. CODE
					S R <input type="checkbox"/> <input type="checkbox"/>
					S R <input type="checkbox"/> <input type="checkbox"/>
					S R <input type="checkbox"/> <input type="checkbox"/>
					S R <input type="checkbox"/> <input type="checkbox"/>
					S R <input type="checkbox"/> <input type="checkbox"/>

33. PROPERTY DAMAGE AMOUNT \$ _____ 34. INSURANCE COMPANY _____

35. OFFICER ASSAULTED Y N 36. ARSON Y N 37. STRUCTURE CODE _____ 38. DAMAGE \$ _____

47. CIB	ENTERED <input type="checkbox"/>	CANCELLED <input type="checkbox"/>	48. TOTAL AMOUNT PROPERTY STOLEN \$ _____
NCIC	<input type="checkbox"/>	<input type="checkbox"/>	
OTHER BROADCAST	<input type="checkbox"/>	<input type="checkbox"/>	
			49. TOTAL AMOUNT PROPERTY RECOVERED \$ _____

50. IS REPORT CONTINUED? YES NO 51. CAUTION INDICATORS, ATLS ETC.

52. DATA PROCESS INFORMATION:

COMPUTER ENTERED DATE 3.8.99

MICROFILM INDEXED INITIAL KS

IS CASE CLASSIFICATION CORRECT? Y N
IF N HAS CORRECTION BEEN MADE? Y N

53. FILE APPROVAL
BY KR DATE 0308.99

1. CASE # S99 N^o 00708 | 2. CLASSIFICATION 6.310.11 | 3. CENSUS 7.010.00

4. INCIDENT CS/ S99-00242

5. INCIDENT LOCATION City of Shawano

6. NAME - LAST - FIRST - MI ANONYMOUS (2) | 7. D.O.B.

8. ADDRESS | 9. TX-HOME

11. CITY STATE ZIP | 10. TX-BUSINESS

12. DETAILS
 Caller states he saw a
 Black Chev Blazer w/
 front end damage - both
 sides, twice in city of Shawano
 NO PLATE #.

MANITOWOC COUNTY SHERIFF
 INCIDENT CARD

18. ASSIGNED MTSO 9/29

19. REC. BY 945 | 20. DIS. BY —

22. TYPE OF REPORT
 1. INCIDENT
 2. ACCIDENT
 3. CITATION
 4. NONE

21. HOW REC'D.
 1. 911
 2. POLICE RADIO
 3. PHONE
 4. TTY
 5. IN PERSON
 6. ON VIEW
 7. OFF. OFF DUTY
 8. C.B. RADIO
 9. OTHER CS

23. STATUS
 1. UNFOUNDED
 2. PNL
 3. OTHER
 4. CLEARED
 5. EXCEPT CLEARED

24. DATE CLEARED 10/3/89

25. OFFENSE TYPE
 1. ADULT NA
 2. JUVENILE
 3. UNKNOWN

14. REC'D | 15. DISP | 16. 10-23 | 17. 10-24

13. DAY
 SUN 1 THU 5
 MON 2 FRI 6
 TUE 3 SAT 7
 WED 4

39. (CODE S-SUSPECT W-WITNESS V-VICTIM O-OTHER)				42. ADDRESS	43. TELEPHONE
ODE	40. NAME-LAST	FIRST	MI	41. D.O.B.	

unable to do any follow up with given info. TTY sent to Shawano PD to watch out for any vehicles matching this discription.

CASE # S99 N^o 0070

45. IF COMPLAINANT DIFFERENT THEN CALLER, ENTER NAME, ADDRESS, D.O.B., TELEPHONE.

46. IF CODE O (OTHER) IS USED IN FIELD #39, EXPLAIN.

INCIDENT REPORT: NOTE: IF SECTION 22 ABOVE HAS NUMBER 4 CHECKED, DO NOT GO BEYOND THIS LINE WITHOUT RECORDS SECTION BEING ADVISED, OR NO RECORD ENTRIES WILL BE MADE BELOW THIS LINE.

PROPERTY VALUE	26. PROPERTY	A. CURRENCY	B. JEWELRY	C. FURS CLOTHING	D. VEHICLE (LOCAL)	E. OFFICE EQUIPMENT	F. RADIO, TV CAMERAS	G. FIREARMS	H. HOUSE HOLD GOOI
	STOLEN	\$	\$	\$	\$	\$	\$	\$	\$
	RECOVERED	\$	\$	\$	\$	\$	\$	\$	\$
	26. PROPERTY	I. CONSUM- ABLES	J. LIVESTOCK	K. DRUGS	L. MARINE ITEMS	M. CONSTRUC- TION ITEMS	N. LAWN AND GARDEN	O. SPORTING GOODS	P. MISC BICYCLE
	STOLEN	\$	\$	\$	\$	\$	\$	\$	\$
	RECOVERED	\$	\$	\$	\$	\$	\$	\$	\$

27. PROPERTY RECOVERED: LOCALLY ____ OTHER JURISDICTION ____ (INSERT O OR L)

PROPERTY ITEMIZATION	PROPERTY STOLEN/RECOVERED ITEMIZATION, USE THE FOLLOWING FORMAT				
	28. QUANTITY	29. ARTICLE NAME	30. BRAND NAME	31. SERIAL NUMBER	
					S R <input type="checkbox"/> <input type="checkbox"/>
					S R <input type="checkbox"/> <input type="checkbox"/>
					S R <input type="checkbox"/> <input type="checkbox"/>
					S R <input type="checkbox"/> <input type="checkbox"/>

33. PROPERTY DAMAGE AMOUNT \$ _____

34. INSURANCE COMPANY _____

35. OFFICER ASSAULTED Y N

36. ARSON Y N

37. STRUCTURE CODE _____

38. DAMAGE \$ _____

47. CIB

ENTERED

CANCELLED

NCIC

OTHER BROADCAST

48. TOTAL AMOUNT PROPERTY STOLEN \$ _____

49. TOTAL AMOUNT PROPERTY RECOVERED \$ _____

50. IS REPORT CONTINUED? YES NO

YES NO

51. CAUTION INDICATORS, ATLS ETC.

52. DATA PROCESS INFORMATION:

COMPUTER ENTERED

DATE

3.8.99

MICROFILM INDEXED

INITIAL

KS

IS CASE CLASSIFICATION CORRECT?
IF N HAS CORRECTION BEEN MADE?

Y N
 Y N

53. FILE APPROVAL

BY

KP

DATE

030899

399 11- 00100 16,510/1 17,00,00

4. INCIDENT *CS/599-00242*

5. INCIDENT LOCATION *St Frances - outside Milwaukee*

6. NAME - LAST - FIRST - MI *ANONYMOUS (2)* 7. D.O.B.

8. ADDRESS 9. TX-HOME

11. CITY STATE ZIP 10. TX-BUSINESS

12. DETAILS
Caller states there is a Blue Silver Blazer on flatbed truck just traded in. Has @ side front end damage. Location -

INCIDENT CARD

18. ASSIGNED *MTSO* *9217*

19. REC. BY *943* 20. DIS. BY

21. HOW REC'D.
 1. 911
 2. POLICE RADIO
 3. PHONE
 4. TTY
 5. IN PERSON
 6. ON VIEW
 7. OFF. OFF DUTY
 8. C.B. RADIO
 9. OTHER *CS*

22. TYPE OF REPORT
 1. INCIDENT
 2. ACCIDENT
 3. CITATION
 4. NONE

23. STATUS
 1. UNFOUNDED
 2. PNL
 3. OTHER
 4. CLEARED
 5. EXCEPT CLEARED

24. DATE CLEARED *10/08/99*

25. OFFENSE TYPE
 1. ADULT NA
 2. JUVENILE
 3. UNKNOWN

14. REC'D	15. DISP	16. 10-23	17. 10-24
13. DAY			
SUN 1	THU 5		
MON 2	FRI 6		
TUE 3	SAT 7		
WED 4			

39. (CODE S-SUSPECT W-WITNESS V-VICTIM O-OTHER)				42. ADDRESS	43. TELEPHONE
CODE	40. NAME-LAST	FIRST	MI	41. D.O.B.	

Take Layton to Pennsylvania, turn R, go 200 yds., you'll see it on the corner. 945pg

Contacted Cudahay PD and had them check this vehicle for damage. Received a call back from them, they did check and explained damage to me...S-10 Blazer with minor damage to grill area. From discription it would not be vehicle we are looking for. TJJ

45. IF COMPLAINANT DIFFERENT THEN CALLER, ENTER NAME, ADDRESS, D.O.B., TELEPHONE.

46. IF CODE O (OTHER) IS USED IN FIELD #39, EXPLAIN.

INCIDENT REPORT: NOTE: IF SECTION 22 ABOVE HAS NUMBER 4 CHECKED, DO NOT GO BEYOND THIS LINE WITHOUT RECORDS SECTION BEING ADVISED, OR NO RECORD ENTRIES WILL BE MADE BELOW THIS LINE.

PROPERTY VALUE	26. PROPERTY	A. CURRENCY	B. JEWELRY	C. FURS CLOTHING	D. VEHICLE (LOCAL)	E. OFFICE EQUIPMENT	F. RADIO, TV CAMERAS	G. FIREARMS	H. HOUSE-HOLD GOODS
	STOLEN	\$	\$	\$	\$	\$	\$	\$	\$
	RECOVERED	\$	\$	\$	\$	\$	\$	\$	\$
	26. PROPERTY	I. CONSUMABLES	J. LIVESTOCK	K. DRUGS	L. MARINE ITEMS	M. CONSTRUCTION ITEMS	N. LAWN AND GARDEN	O. SPORTING GOODS	P. MISC BICYCLE
	STOLEN	\$	\$	\$	\$	\$	\$	\$	\$
	RECOVERED	\$	\$	\$	\$	\$	\$	\$	\$

27. PROPERTY RECOVERED: LOCALLY ____ OTHER JURISDICTION ____ (INSERT O OR L)

PROPERTY ITEMIZATION	PROPERTY STOLEN/RECOVERED ITEMIZATION, USE THE FOLLOWING FORMAT				
	28. QUANTITY	29. ARTICLE NAME	30. BRAND NAME	31. SERIAL NUMBER	32. CODE
					S R <input type="checkbox"/> <input type="checkbox"/>
					S R <input type="checkbox"/> <input type="checkbox"/>
					S R <input type="checkbox"/> <input type="checkbox"/>
					S R <input type="checkbox"/> <input type="checkbox"/>

33. PROPERTY DAMAGE AMOUNT \$ _____ 34. INSURANCE COMPANY _____

35. OFFICER ASSAULTED Y N 36. ARSON Y N 37. STRUCTURE CODE _____ 38. DAMAGE \$ _____

47. CIB NCIC OTHER BROADCAST	ENTERED	CANCELLED	48. TOTAL AMOUNT PROPERTY STOLEN \$ _____
	<input type="checkbox"/>	<input type="checkbox"/>	
	<input type="checkbox"/>	<input type="checkbox"/>	
			49. TOTAL AMOUNT PROPERTY RECOVERED \$ _____

50. IS REPORT CONTINUED? YES NO 51. CAUTION INDICATORS, ATLS ETC.

52. DATA PROCESS INFORMATION:

COMPUTER ENTERED DATE 3.8.99

MICROFILM INDEXED INITIAL KS

IS CASE CLASSIFICATION CORRECT? Y N
IF N HAS CORRECTION BEEN MADE? Y N

53. FILE APPROVAL
BY KP DATE 03.08.99

399 IV- 00121 103011 1144120

4. INCIDENT
CS/599-00242

5. INCIDENT LOCATION
SW corner S. 26th + Silver Creek Rd.

6. NAME - LAST - FIRST - MI
Anony.

7. D.O.B.

8. ADDRESS

9. TX-HOME

11. CITY STATE ZIP

10. TX-BUSINESS

12. DETAILS
Blw Chev-truck w/reg
22570F parked in fairyard
w/in past hour. It has
gill damage.

INCIDENT CARD

18. ASSIGNED
MTSD 9219
Glaeser 4117

19. REC. BY
920922

20. DIS. BY

22. TYPE OF REPORT
1. INCIDENT
2. ACCIDENT
3. CITATION
4. NONE

21. HOW REC'D.
1. 911
2. POLICE RADIO
3. PHONE
4. TTY
5. IN PERSON
6. ON VIEW
7. OFF. OFF DUTY
8. C.B. RADIO
9. OTHER

23. STATUS
1. UNFOUNDED
2. PNL
3. OTHER
4. CLEARED
5. EXCEPT CLEARED

24. DATE CLEARED
03/08/99

25. OFFENSE TYPE
1. ADULT NA
2. JUVENILE
3. UNKNOWN

14. REC'D	15. DISP	16. 10-23	17. 10-24
13. DAY			
SUN 1	THU 5		
MON 2	FRI 6		
TUE 3	SAT 7		
WED 4			

39. (CODE S-SUSPECT W-WITNESS V-VICTIM O-OTHER)				41. D.O.B.	42. ADDRESS	43. TELEPHONE
CODE	40. NAME-LAST	FIRST	MI			

01/23/99 @ 1005 Hrs Deputy E. Glaeser checked on this complaint and recognized the vehicle as the one photographed by 432 with Lt. Bushman. The owner was contacted and he verified the vehicle had been checked. Dispatch was advised to post the address of [redacted] Silver Creek Road as already being checked.

EJG
ETC

45. IF COMPLAINANT DIFFERENT THEN CALLER, ENTER NAME, ADDRESS, D.O.B., TELEPHONE.

46. IF CODE O (OTHER) IS USED IN FIELD #39, EXPLAIN.

INCIDENT REPORT: NOTE: IF SECTION 22 ABOVE HAS NUMBER 4 CHECKED, DO NOT GO BEYOND THIS LINE WITHOUT RECORDS SECTION BEING ADVISED, OR NO RECORD ENTRIES WILL BE MADE BELOW THIS LINE.

PROPERTY VALUE	26. PROPERTY	A. CURRENCY	B. JEWELRY	C. FURS CLOTHING	D. VEHICLE (LOCAL)	E. OFFICE EQUIPMENT	F. RADIO, TV CAMERAS	G. FIREARMS	H. HOUSE-HOLD GOODS
	STOLEN	\$	\$	\$	\$	\$	\$	\$	\$
	RECOVERED	\$	\$	\$	\$	\$	\$	\$	\$
	26. PROPERTY	I. CONSUMABLES	J. LIVESTOCK	K. DRUGS	L. MARINE ITEMS	M. CONSTRUCTION ITEMS	N. LAWN AND GARDEN	O. SPORTING GOODS	P. MISC BICYCLE
	STOLEN	\$	\$	\$	\$	\$	\$	\$	\$
	RECOVERED	\$	\$	\$	\$	\$	\$	\$	\$

27. PROPERTY RECOVERED: LOCALLY _____ OTHER JURISDICTION _____ (INSERT O OR L)

PROPERTY ITEMIZATION	PROPERTY STOLEN/RECOVERED ITEMIZATION, USE THE FOLLOWING FORMAT				
	28. QUANTITY	29. ARTICLE NAME	30. BRAND NAME	31. SERIAL NUMBER	32. CODE
					S R <input type="checkbox"/> <input type="checkbox"/>
					S R <input type="checkbox"/> <input type="checkbox"/>
					S R <input type="checkbox"/> <input type="checkbox"/>
					S R <input type="checkbox"/> <input type="checkbox"/>

33. PROPERTY DAMAGE AMOUNT \$ _____ 34. INSURANCE COMPANY _____

35. OFFICER ASSAULTED Y N 36. ARSON Y N 37. STRUCTURE CODE _____ 38. DAMAGE \$ _____

47. CIB	ENTERED <input type="checkbox"/>	CANCELLED <input type="checkbox"/>	48. TOTAL AMOUNT PROPERTY STOLEN \$ _____
NCIC	<input type="checkbox"/>	<input type="checkbox"/>	
OTHER BROADCAST	<input type="checkbox"/>	<input type="checkbox"/>	
49. TOTAL AMOUNT PROPERTY RECOVERED \$ _____			

50. IS REPORT CONTINUED? YES NO 51. CAUTION INDICATORS, ATLS ETC.

52. DATA PROCESS INFORMATION:

COMPUTER ENTERED DATE 3.8.99

MICROFILM INDEXED INITIAL KS

IS CASE CLASSIFICATION CORRECT? Y N

IF N HAS CORRECTION BEEN MADE? Y N

53. FILE APPROVAL

BY RP DATE 03.08.99

333 14 00120 1631011 1641000

4. INCIDENT CS/599-00242

5. INCIDENT LOCATION

6. NAME - LAST - FIRST - MI ANONYMOUS 7. D.O.B.

8. ADDRESS 9. TX-HOME

11. CITY STATE ZIP 10. TX-BUSINESS

12. DETAILS
 Caller states they saw dark marron small
 pick up truck operating on roadway last week
 Tues. 01/19/99 sb on N. 21st. with a part-
 ial plate of PHE-___ with front drivers
 grill damage.

14. REC'D	15. DISP	16. 10-23	17. 10-24
13. DAY			
SUN 1	THU 5		
MON 2	FRI 6		
TUE 3	SAT 7		
WED 4			

INCIDENT CARD

18. ASSIGNED MTSO 929

19. REC. BY 923 20. DIS. BY

21. HOW REC'D.
 1. 911
 2. POLICE RADIO
 3. **PHONE**
 4. TTY
 5. IN PERSON
 6. ON VIEW
 7. OFF. OFF DUTY
 8. C.B. RADIO
 9. OTHER

22. TYPE OF REPORT
 1. **INCIDENT**
 2. ACCIDENT
 3. CITATION
 4. NONE

23. STATUS
 1. UNFOUNDED
 2. PNL
 3. **OTHER**
 4. CLEARED
 5. EXCEPT CLEARED

24. DATE CLEARED 03 18 199

25. OFFENSE TYPE
 1. ADULT NA
 2. JUVENILE
 3. UNKNOWN

21A. M.O.

39. (CODE S-SUSPECT W-WITNESS V-VICTIM O-OTHER)

CODE	40. NAME-LAST	FIRST	MI	41. D.O.B.	42. ADDRESS	43. TELEPHONE

45. IF COMPLAINANT DIFFERENT THEN CALLER, ENTER NAME, ADDRESS, D.O.B., TELEPHONE.

46. IF CODE O (OTHER) IS USED IN FIELD #39, EXPLAIN.

INCIDENT REPORT: NOTE: IF SECTION 22 ABOVE HAS NUMBER 4 CHECKED, DO NOT GO BEYOND THIS LINE WITHOUT RECORDS SECTION BEING ADVISED, OR NO RECORD ENTRIES WILL BE MADE BELOW THIS LINE.

PROPERTY VALUE	26. PROPERTY	A. CURRENCY	B. JEWELRY	C. FURS CLOTHING	D. VEHICLE (LOCAL)	E. OFFICE EQUIPMENT	F. RADIO, TV CAMERAS	G. FIREARMS	H. HOUSE-HOLD GOODS
	STOLEN	\$	\$	\$	\$	\$	\$	\$	\$
	RECOVERED	\$	\$	\$	\$	\$	\$	\$	\$
	26. PROPERTY	I. CONSUMABLES	J. LIVESTOCK	K. DRUGS	L. MARINE ITEMS	M. CONSTRUCTION ITEMS	N. LAWN AND GARDEN	O. SPORTING GOODS	P. MISC BICYCLE
	STOLEN	\$	\$	\$	\$	\$	\$	\$	\$
	RECOVERED	\$	\$	\$	\$	\$	\$	\$	\$

27. PROPERTY RECOVERED: LOCALLY ____ OTHER JURISDICTION ____ (INSERT O OR L)

PROPERTY ITEMIZATION	PROPERTY STOLEN/RECOVERED ITEMIZATION, USE THE FOLLOWING FORMAT				
	28. QUANTITY	29. ARTICLE NAME	30. BRAND NAME	31. SERIAL NUMBER	32. CODE
					S R <input type="checkbox"/> <input type="checkbox"/>
					S R <input type="checkbox"/> <input type="checkbox"/>
					S R <input type="checkbox"/> <input type="checkbox"/>
					S R <input type="checkbox"/> <input type="checkbox"/>

33. PROPERTY DAMAGE AMOUNT \$ _____ 34. INSURANCE COMPANY _____

35. OFFICER ASSAULTED Y N 36. ARSON Y N 37. STRUCTURE CODE _____ 38. DAMAGE \$ _____

47. CIB	ENTERED <input type="checkbox"/>	CANCELLED <input type="checkbox"/>	48. TOTAL AMOUNT PROPERTY STOLEN \$ _____
NCIC	<input type="checkbox"/>	<input type="checkbox"/>	
OTHER BROADCAST	<input type="checkbox"/>	<input type="checkbox"/>	49. TOTAL AMOUNT PROPERTY RECOVERED \$ _____

50. IS REPORT CONTINUED? YES NO 51. CAUTION INDICATORS, ATLS ETC.

52. DATA PROCESS INFORMATION:

COMPUTER ENTERED DATE 3/8/99

MICROFILM INDEXED INITIAL AS

IS CASE CLASSIFICATION CORRECT? Y N

IF N HAS CORRECTION BEEN MADE? Y N

53. FILE APPROVAL

BY RP DATE 3/08/99

000 19- 00720 16,510,1 16,000,0

4. INCIDENT
C.S./599-00242

5. INCIDENT LOCATION
COLUMBUS ST. 1000 block

6. NAME - LAST - FIRST - MI
ANON 2

7. D.O.B.

8. ADDRESS

9. TX-HOME

11. CITY STATE ZIP

10. TX-BUSINESS

12. DETAILS
SEE ATTACHED FORM FOR
C.S. REPORT.

INCIDENT CARD

18. ASSIGNED
Jost H.H.P.
MISO C.S. 929

19. REC. BY
923

20. DIS. BY

22. TYPE OF REPORT
① INCIDENT
2. ACCIDENT
3. CITATION
4. NONE

21. HOW REC'D.
1. 911
2. POLICE RADIO
③ PHONE
4. TTY
5. IN PERSON
6. ON VIEW
7. OFF. OFF DUTY
8. C.B. RADIO
9. OTHER

23. STATUS
1. UNFOUNDED
2. PNL
③ OTHER
4. CLEARED
5. EXCEPT CLEARED

24. DATE CLEARED
103 108 199

25. OFFENSE TYPE
1. ADULT NA
2. JUVENILE
3. UNKNOWN

14. REC'D
15. DISP
16. 10-23
17. 10-24

13. DAY
SUN 1 THU 5
MON 2 FRI 6
TUE 3 SAT 7
WED 4

39. (CODE S-SUSPECT W-WITNESS V-VICTIM O-OTHER)				41. D.O.B.		42. ADDRESS		43. TELEPHONE	
CODE	40. NAME-LAST	FIRST	MI						
0	Marquardt,	3/317	Cathlyn	A.			Columbus St.		

On 01-23-99 I, Deputy Jost, made contact with Cathlyn reference the attached crimestopper report. She advised she does not own a van and allowed me to look in her garage, described in the report. No van was found in the garage. She told me that one of her nephews friends, a Scott Miller, owns a gray or blue colored Chev truck. An in house check indicated Scott lives at [redacted] Broadway St.. He is out of town according to Cathlyn.

I also talked to a subject that resides at [redacted] Columbus. The garage behind this residence also somewhat matched the description. He told me the occupants downstairs and the resident in the front upper apt's. have the two garages in back. No contact made at either of those two residences. Follow-up should be conducted. *[Signature]* JMJ

012399 2054 hrs: MTPD Officers Ladwig and Weyer attempted to check both residences at [redacted] Columbus St. No one was at home. They talked to neighbors and they were pretty sure that either party did not own a veh matching the description. 935/lms

01-24-99 at 1703 hrs. I, Deputy Jost, checked on Scott Millers residence, [redacted] Broadway St., reference his truck that Cathlyn informed me of. The 10-28 is attached and as indicated it is a 88 Chev S-10 truck. Not a match and no damage. *[Signature]* JMJ

45. IF COMPLAINANT DIFFERENT THEN CALLER, ENTER NAME, ADDRESS, D.O.B., TELEPHONE.

46. IF CODE O (OTHER) IS USED IN FIELD #39, EXPLAIN.

INCIDENT REPORT: NOTE: IF SECTION 22 ABOVE HAS NUMBER 4 CHECKED, DO NOT GO BEYOND THIS LINE WITHOUT RECORDS SECTION BEING ADVISED, OR NO RECORD ENTRIES WILL BE MADE BELOW THIS LINE.

PROPERTY VALUE	26. PROPERTY	A. CURRENCY	B. JEWELRY	C. FURS CLOTHING	D. VEHICLE (LOCAL)	E. OFFICE EQUIPMENT	F. RADIO, TV CAMERAS	G. FIREARMS	H. HOUSE-HOLD GOODS
	STOLEN	\$	\$	\$	\$	\$	\$	\$	\$
	RECOVERED	\$	\$	\$	\$	\$	\$	\$	\$
	26. PROPERTY	I. CONSUMABLES	J. LIVESTOCK	K. DRUGS	L. MARINE ITEMS	M. CONSTRUCTION ITEMS	N. LAWN AND GARDEN	O. SPORTING GOODS	P. MISC BICYCLE
	STOLEN	\$	\$	\$	\$	\$	\$	\$	\$
	RECOVERED	\$	\$	\$	\$	\$	\$	\$	\$

27. PROPERTY RECOVERED: LOCALLY _____ OTHER JURISDICTION _____ (INSERT O OR L)

PROPERTY ITEMIZATION	PROPERTY STOLEN/RECOVERED ITEMIZATION, USE THE FOLLOWING FORMAT				
	28. QUANTITY	29. ARTICLE NAME	30. BRAND NAME	31. SERIAL NUMBER	32. CODE
					S R <input type="checkbox"/> <input type="checkbox"/>
					S R <input type="checkbox"/> <input type="checkbox"/>
					S R <input type="checkbox"/> <input type="checkbox"/>
					S R <input type="checkbox"/> <input type="checkbox"/>
					S R <input type="checkbox"/> <input type="checkbox"/>

33. PROPERTY DAMAGE AMOUNT \$ _____ 34. INSURANCE COMPANY _____

35. OFFICER ASSAULTED Y N 36. ARSON Y N 37. STRUCTURE CODE _____ 38. DAMAGE \$ _____

47. CIB NCIC OTHER BROADCAST	ENTERED	CANCELLED	48. TOTAL AMOUNT PROPERTY STOLEN \$ _____
	<input type="checkbox"/>	<input type="checkbox"/>	
	<input type="checkbox"/>	<input type="checkbox"/>	
			49. TOTAL AMOUNT PROPERTY RECOVERED \$ _____

50. IS REPORT CONTINUED? YES NO 51. CAUTION INDICATORS, ATLS ETC.

52. DATA PROCESS INFORMATION:

COMPUTER ENTERED DATE 3/8/99

MICROFILM INDEXED INITIAL KS

IS CASE CLASSIFICATION CORRECT? N

IF N HAS CORRECTION BEEN MADE? N

53. FILE APPROVAL

BY KS DATE 03p8 99

555 IV- 00121 | 6,30,11 | 6,00,0,0

4. INCIDENT
CS/S99-00242

5. INCIDENT LOCATION

6. NAME- LAST-FIRST-MI
Anonymous 2 7 D.O.B.

8. ADDRESS 9. TX-HOME

11. CITY STATE ZIP 10. TX-BUSINESS

12. DETAILS
11592
Infor suspecting George R. Schuh living on
Carstens Ld Rd. drives a blue truck. He
~~used to park right in the middle of the drive-~~
~~way and now for the past week or two the~~
~~vehicle has not been there.~~

14. REC'D

15. DISP

16. 10-23

17. 10-24

13. DAY
SUN 1 THU 5
MON 2 FRI 6
TUE 3 **SAT 7**
WED 4

INCIDENT CARD

18. ASSIGNED
MTSO 9 | 2 | 9

19. REC. BY
923

20. DIS. BY

21. HOW REC'D.
1. 911
2. POLICE RADIO
3. **PHONE**
4. TY
5. IN PERSON
6. ON VIEW
7. OFF. OFF DUTY
8. C.B. RADIO
9. OTHER

22. TYPE OF REPORT
1. **INCIDENT**
2. ACCIDENT
3. CITATION
4. NONE

23. STATUS
1. UNFOUNDED
2. PNL
3. **OTHER**
4. CLEARED
5. EXCEPT CLEARED

24. DATE CLEARED
103 08 99

25. OFFENSE TYPE
1. ADULT NA
2. JUVENILE
3. UNKNOWN

21A. M.O.

39. (CODE S-SUSPECT W-WITNESS V-VICTIM O-OTHER)				41. D.O.B.		42. ADDRESS		43. TELEPHONE	
CODE	40. NAME-LAST	FIRST	MI						

Information of these details were passed on to special Crimstopper Officer Jost and he advised that this subject has already been checked. *lak/lab*

45. IF COMPLAINANT DIFFERENT THEN CALLER, ENTER NAME, ADDRESS, D.O.B., TELEPHONE.

46. IF CODE O (OTHER) IS USED IN FIELD #39, EXPLAIN.

INCIDENT REPORT: NOTE: IF SECTION 22 ABOVE HAS NUMBER 4 CHECKED, DO NOT GO BEYOND THIS LINE WITHOUT RECORDS SECTION BEING ADVISED, OR NO RECORD ENTRIES WILL BE MADE BELOW THIS LINE.

PROPERTY VALUE	26. PROPERTY	A. CURRENCY	B. JEWELRY	C. FURS CLOTHING	D. VEHICLE (LOCAL)	E. OFFICE EQUIPMENT	F. RADIO, TV CAMERAS	G. FIREARMS	H. HOUSE-HOLD GOODS
	STOLEN	\$	\$	\$	\$	\$	\$	\$	\$
	RECOVERED	\$	\$	\$	\$	\$	\$	\$	\$
	26. PROPERTY	I. CONSUM-ABLES	J. LIVESTOCK	K. DRUGS	L. MARINE ITEMS	M. CONSTRUCTION ITEMS	N. LAWN AND GARDEN	O. SPORTING GOODS	P. MISC BICYCLE
	STOLEN	\$	\$	\$	\$	\$	\$	\$	\$
	RECOVERED	\$	\$	\$	\$	\$	\$	\$	\$

27. PROPERTY RECOVERED: LOCALLY _____ OTHER JURISDICTION _____ (INSERT O OR L)

PROPERTY ITEMIZATION	PROPERTY STOLEN/RECOVERED ITEMIZATION, USE THE FOLLOWING FORMAT				
	28. QUANTITY	29. ARTICLE NAME	30. BRAND NAME	31. SERIAL NUMBER	32. CODE
					S R <input type="checkbox"/> <input type="checkbox"/>
					S R <input type="checkbox"/> <input type="checkbox"/>
					S R <input type="checkbox"/> <input type="checkbox"/>
					S R <input type="checkbox"/> <input type="checkbox"/>
					S R <input type="checkbox"/> <input type="checkbox"/>

33. PROPERTY DAMAGE AMOUNT \$ _____ 34. INSURANCE COMPANY _____

35. OFFICER ASSAULTED Y N 36. ARSON Y N 37. STRUCTURE CODE _____ 38. DAMAGE \$ _____

47. CIB	ENTERED <input type="checkbox"/>	CANCELLED <input type="checkbox"/>	48. TOTAL AMOUNT PROPERTY STOLEN \$ _____
NCIC	<input type="checkbox"/>	<input type="checkbox"/>	
OTHER BROADCAST	<input type="checkbox"/>	<input type="checkbox"/>	
			49. TOTAL AMOUNT PROPERTY RECOVERED \$ _____

50. IS REPORT CONTINUED? YES NO 51. CAUTION INDICATORS, ATLS ETC.

52. DATA PROCESS INFORMATION:

COMPUTER ENTERED DATE 3.8.99

MICROFILM INDEXED INITIAL KS

IS CASE CLASSIFICATION CORRECT? Y N

IF N HAS CORRECTION BEEN MADE? Y N

53. FILE APPROVAL

BY KS DATE 03.08.99

INCIDENT CARD

399 14- 00700 1021471 16201900

4. INCIDENT
CS 1599-0024Z

5. INCIDENT LOCATION
OTH CR

6. NAME LAST-FIRST-MI
[REDACTED]

7. D.O.B.
[REDACTED]

8. ADDRESS
[REDACTED]

9. TX-HOME
[REDACTED]

11. CITY STATE ZIP
[REDACTED]

10. TX-BUSINESS
[REDACTED]

12. DETAILS
TNM 929 Blue Chev Blazer
Slight front end damage

18. ASSIGNED
MISO 9/21/99
Glaeser 4/1/99

19. REC. BY
933

20. DIS. BY
933

21. HOW REC'D.
1. 911
2. POLICE RADIO
3. PHONE
4. TTY
5. IN PERSON
6. ON VIEW
7. OFF. OFF DUTY
8. C.B. RADIO
9. OTHER

22. TYPE OF REPORT
1. INCIDENT
2. ACCIDENT
3. CITATION
4. NONE

23. STATUS
1. UNFOUNDED
2. PNL
3. OTHER
4. CLEARED
5. EXCEPT CLEARED

24. DATE CLEARED
F8 P8 1999

25. OFFENSE TYPE
1. ADULT NA
2. JUVENILE
3. UNKNOWN

14. REC'D	15. DISP	16. 10-23	17. 10-24
13. DAY			
SUN 1	THU 5		
MON 2	FRI 6		
TUE 3	SAT 7		
WED 4			

39. (CODE S-SUSPECT W-WITNESS V-VICTIM O-OTHER)						
CODE	40. NAME-LAST	FIRST	MI	41. D.O.B.	42. ADDRESS	43. TELEPHONE

0740HRS.

01/24/99 Deputy Glaeser checked the vehicle as it was located at Petersons. Vehicle is a K-5 Blazer with no grill damage making it not suspect. EJJ

ETG

45. IF COMPLAINANT DIFFERENT THEN CALLER, ENTER NAME, ADDRESS, D.O.B., TELEPHONE.

46. IF CODE O (OTHER) IS USED IN FIELD #39, EXPLAIN.

INCIDENT REPORT: NOTE: IF SECTION 22 ABOVE HAS NUMBER 4 CHECKED, DO NOT GO BEYOND THIS LINE WITHOUT RECORDS SECTION BEING ADVISED, OR NO RECORD ENTRIES WILL BE MADE BELOW THIS LINE.

PROPERTY VALUE	26. PROPERTY	A. CURRENCY	B. JEWELRY	C. FURS CLOTHING	D. VEHICLE (LOCAL)	E. OFFICE EQUIPMENT	F. RADIO, TV CAMERAS	G. FIREARMS	H. HOUSE-HOLD GOODS
	STOLEN	\$	\$	\$	\$	\$	\$	\$	\$
	RECOVERED	\$	\$	\$	\$	\$	\$	\$	\$
	26. PROPERTY	I. CONSUMABLES	J. LIVESTOCK	K. DRUGS	L. MARINE ITEMS	M. CONSTRUCTION ITEMS	N. LAWN AND GARDEN	O. SPORTING GOODS	P. MISC BICYCLE
	STOLEN	\$	\$	\$	\$	\$	\$	\$	\$
	RECOVERED	\$	\$	\$	\$	\$	\$	\$	\$

27. PROPERTY RECOVERED: LOCALLY _____ OTHER JURISDICTION _____ (INSERT O OR L)

PROPERTY ITEMIZATION	PROPERTY STOLEN/RECOVERED ITEMIZATION, USE THE FOLLOWING FORMAT				
	28. QUANTITY	29. ARTICLE NAME	30. BRAND NAME	31. SERIAL NUMBER	32. CODE
					S R <input type="checkbox"/> <input type="checkbox"/>
					S R <input type="checkbox"/> <input type="checkbox"/>
					S R <input type="checkbox"/> <input type="checkbox"/>
					S R <input type="checkbox"/> <input type="checkbox"/>
					S R <input type="checkbox"/> <input type="checkbox"/>

33. PROPERTY DAMAGE AMOUNT \$ _____ 34. INSURANCE COMPANY _____

35. OFFICER ASSAULTED Y N 36. ARSON Y N 37. STRUCTURE CODE _____ 38. DAMAGE \$ _____

47. CIB	ENTERED <input type="checkbox"/>	CANCELLED <input type="checkbox"/>	48. TOTAL AMOUNT PROPERTY STOLEN \$ _____
NCIC	<input type="checkbox"/>	<input type="checkbox"/>	49. TOTAL AMOUNT PROPERTY RECOVERED \$ _____
OTHER BROADCAST	<input type="checkbox"/>	<input type="checkbox"/>	

50. IS REPORT CONTINUED? YES NO 51. CAUTION INDICATORS, ATLS ETC.

52. DATA PROCESS INFORMATION:

COMPUTER ENTERED DATE 3/8/99

MICROFILM INDEXED INITIAL KS

IS CASE CLASSIFICATION CORRECT? N

IF N HAS CORRECTION BEEN MADE? N

53. FILE APPROVAL

BY RP DATE 03/08/99

599.14- 00100 10.20.11, 11.7.11.2

4. INCIDENT CS/S99-00242

5. INCIDENT LOCATION
Clover Road

6. NAME - LAST - FIRST - MI ANON 7. D.O.B.

8. ADDRESS 9. TX-HOME

11. CITY STATE ZIP 10. TX-BUSINESS

12. DETAILS
Caller overheard people at work talking about a vehicle parked in a pole barn/garage near the tavern Oldies But Goodies. It is covered with a tarp and has damage to the front grill area. No further description or location.

16:43 1-23-99

14. REC'D. 15. DISP. 16. 10-23 17. 10-24

13. DAY
SUN 1 THU 5
MON 2 FRI 6
TUE 3 SAT 7
WED 4

INCIDENT CARD

18. ASSIGNED
Tackes 49.8
Sgt Janssen 41.4
9.2.9

19. REC. BY 926 20. DIS. BY

21. HOW REC'D.
1. 911
2. POLICE RADIO
3. PHONE
4. TTY
5. IN PERSON
6. ON VIEW
7. OFF. OFF DUTY
8. C.B. RADIO
9. OTHER

22. TYPE OF REPORT
1. INCIDENT
2. ACCIDENT
3. CITATION
4. NONE

23. STATUS
1. UNFOUNDED
2. PNL
3. OTHER
4. CLEARED
5. EXCEPT CLEARED

24. DATE CLEARED 103 108 199

25. OFFENSE TYPE
1. ADULT NA
2. JUVENILE
3. UNKNOWN

21A. M.O.

39. (CODE S-SUSPECT W-WITNESS V-VICTIM O-OTHER)

CODE	40. NAME-LAST	FIRST	MI	41. D.O.B.	42. ADDRESS	43. TELEPHONE

Dep Tackes checked the above location and discovered that the vehicle was a Dodge pickup truck. It didnot have any front end damage. *[Signature]*

45. IF COMPLAINANT DIFFERENT THEN CALLER, ENTER NAME, ADDRESS, D.O.B., TELEPHONE.

46. IF CODE O (OTHER) IS USED IN FIELD #39, EXPLAIN.

INCIDENT REPORT: NOTE: IF SECTION 22 ABOVE HAS NUMBER 4 CHECKED, DO NOT GO BEYOND THIS LINE WITHOUT RECORDS SECTION BEING ADVISED, OR NO RECORD ENTRIES WILL BE MADE BELOW THIS LINE.

PROPERTY VALUE	26. PROPERTY	A. CURRENCY	B. JEWELRY	C. FURS CLOTHING	D. VEHICLE (LOCAL)	E. OFFICE EQUIPMENT	F. RADIO, TV CAMERAS	G. FIREARMS	H. HOUSE-HOLD GOODS
	STOLEN	\$	\$	\$	\$	\$	\$	\$	\$
	RECOVERED	\$	\$	\$	\$	\$	\$	\$	\$
	26. PROPERTY	I. CONSUM-ABLES	J. LIVESTOCK	K. DRUGS	L. MARINE ITEMS	M. CONSTRUCTION ITEMS	N. LAWN AND GARDEN	O. SPORTING GOODS	P. MISC BICYCLE
STOLEN	\$	\$	\$	\$	\$	\$	\$	\$	
RECOVERED	\$	\$	\$	\$	\$	\$	\$	\$	

27. PROPERTY RECOVERED: LOCALLY _____ OTHER JURISDICTION _____ (INSERT O OR L)

PROPERTY ITEMIZATION	PROPERTY STOLEN/RECOVERED ITEMIZATION, USE THE FOLLOWING FORMAT				
	28. QUANTITY	29. ARTICLE NAME	30. BRAND NAME	31. SERIAL NUMBER	32. CODE
					S R <input type="checkbox"/> <input type="checkbox"/>
					S R <input type="checkbox"/> <input type="checkbox"/>
					S R <input type="checkbox"/> <input type="checkbox"/>
					S R <input type="checkbox"/> <input type="checkbox"/>
					S R <input type="checkbox"/> <input type="checkbox"/>

33. PROPERTY DAMAGE AMOUNT \$ _____ 34. INSURANCE COMPANY _____

35. OFFICER ASSAULTED Y N 36. ARSON Y N 37. STRUCTURE CODE _____ 38. DAMAGE \$ _____

47. CIB	ENTERED <input type="checkbox"/>	CANCELLED <input type="checkbox"/>	48. TOTAL AMOUNT PROPERTY STOLEN \$ _____
NCIC	<input type="checkbox"/>	<input type="checkbox"/>	
OTHER BROADCAST	<input type="checkbox"/>	<input type="checkbox"/>	
			49. TOTAL AMOUNT PROPERTY RECOVERED \$ _____

50. IS REPORT CONTINUED? YES NO 51. CAUTION INDICATORS, ATLS ETC.

52. DATA PROCESS INFORMATION:

COMPUTER ENTERED DATE 03 08 99

MICROFILM INDEXED INITIAL AS

IS CASE CLASSIFICATION CORRECT? Y N

IF N HAS CORRECTION BEEN MADE? Y N

53. FILE APPROVAL

BY R DATE 03 08 99

599 172 00101 16510.11 10210.00

INCIDENT CARD

4. INCIDENT
- (S) 599-00242

5. INCIDENT LOCATION
LTH CR

6. NAME - LAST, FIRST, MI
[REDACTED]

7. D.O.B.
[REDACTED]

8. ADDRESS
[REDACTED]

9. TX-HOME
[REDACTED]

11. CITY STATE ZIP
[REDACTED]

10. TX-BUSINESS
[REDACTED]

12. DETAILS
Chev P.U. w/ For Sale sign
parked near Lindberg & 35th
Had duct tape over grill damage

18. ASSIGNED
MISO 9/21/99
Glaeser 9/11/99

19. REC. BY
933

20. DIS. BY

22. TYPE OF REPORT
① INCIDENT
2. ACCIDENT
3. CITATION
4. NONE

21. HOW REC'D.
1. 911
2. POLICE RADIO
③ PHONE
4. TTY
5. IN-PERSON
6. ON VIEW
7. OFF. OFF DUTY
8. C.B. RADIO
9. OTHER

23. STATUS
1. UNFOUNDED
2. PNL
③ OTHER
4. CLEARED
5. EXCEPT CLEARED

24. DATE CLEARED
10/31/89

25. OFFENSE TYPE
1. ADULT NA
2. JUVENILE
3. UNKNOWN

21A. M.O.
[REDACTED]

14. REC'D	15. DISP	16. 10-23	17. 10-24
SUN 1	THU 5		
MON 2	FRI 6		
TUE 3	SA ⑦		
WED 4			

39. (CODE S-SUSPECT W-WITNESS V-VICTIM O-OTHER)						
CODE	40. NAME-LAST	FIRST	MI	41. D.O.B.	42. ADDRESS	43. TELEPHONE

01/24/99 I Deputy Glaeser can verify this truck has been reported numerous times and had been checked by both MISO and MIPD officers, No need to followup as this is not the suspect vehicle. EJC

45. IF COMPLAINANT DIFFERENT THEN CALLER, ENTER NAME, ADDRESS, D.O.B., TELEPHONE.

46. IF CODE O (OTHER) IS USED IN FIELD #39, EXPLAIN.

INCIDENT REPORT: NOTE: IF SECTION 22 ABOVE HAS NUMBER 4 CHECKED, DO NOT GO BEYOND THIS LINE WITHOUT RECORDS SECTION BEING ADVISED, OR NO RECORD ENTRIES WILL BE MADE BELOW THIS LINE.

PROPERTY VALUE	26. PROPERTY	A. CURRENCY	B. JEWELRY	C. FURS CLOTHING	D. VEHICLE (LOCAL)	E. OFFICE EQUIPMENT	F. RADIO, TV CAMERAS	G. FIREARMS	H. HOUSE-HOLD GOODS
	STOLEN	\$	\$	\$	\$	\$	\$	\$	\$
	RECOVERED	\$	\$	\$	\$	\$	\$	\$	\$
	26. PROPERTY	I. CONSUMABLES	J. LIVESTOCK	K. DRUGS	L. MARINE ITEMS	M. CONSTRUCTION ITEMS	N. LAWN AND GARDEN	O. SPORTING GOODS	P. MISC BICYCLE
	STOLEN	\$	\$	\$	\$	\$	\$	\$	\$
	RECOVERED	\$	\$	\$	\$	\$	\$	\$	\$

27. PROPERTY RECOVERED: LOCALLY ____ OTHER JURISDICTION ____ (INSERT O OR L)

PROPERTY ITEMIZATION	PROPERTY STOLEN/RECOVERED ITEMIZATION, USE THE FOLLOWING FORMAT				
	28. QUANTITY	29. ARTICLE NAME	30. BRAND NAME	31. SERIAL NUMBER	32. CODE
					S R <input type="checkbox"/> <input type="checkbox"/>
					S R <input type="checkbox"/> <input type="checkbox"/>
					S R <input type="checkbox"/> <input type="checkbox"/>
					S R <input type="checkbox"/> <input type="checkbox"/>
					S R <input type="checkbox"/> <input type="checkbox"/>

33. PROPERTY DAMAGE AMOUNT \$ _____

34. INSURANCE COMPANY _____

35. OFFICER ASSAULTED Y N

36. ARSON Y N

37. STRUCTURE CODE _____ 38. DAMAGE \$ _____

47. CIB ENTERED CANCELLED
 NCIC
 OTHER BROADCAST

48. TOTAL AMOUNT PROPERTY STOLEN \$ _____

49. TOTAL AMOUNT PROPERTY RECOVERED \$ _____

50. IS REPORT CONTINUED? YES NO

51. CAUTION INDICATORS, ATLS ETC.

52. DATA PROCESS INFORMATION:
 COMPUTER ENTERED DATE 3/8/99
 MICROFILM INDEXED INITIAL RS
 IS CASE CLASSIFICATION CORRECT? Y N
 IF N HAS CORRECTION BEEN MADE? Y N

53. FILE APPROVAL
 BY RS DATE 3/8/99

555 14- 00700 0121011 14 PPT

4. INCIDENT **CS-599-00242**

5. INCIDENT LOCATION **ON 42 unsure exact.**

6. NAME- LAST-FIRST-MI [REDACTED] 7. D.O.B. [REDACTED]

8. ADDRESS [REDACTED] 9. TX-HOME [REDACTED]

11. CITY [REDACTED] STATE [REDACTED] ZIP [REDACTED] 10. TX-BUSINESS [REDACTED]

12. DETAILS
Saw veh. with broken grill and headlight damage

INCIDENT CARD

18. ASSIGNED **Jost** **944**
929

19. REC. BY **944** 20. DIS. BY [REDACTED]

21. HOW REC'D.
 1. 911
 2. POLICE RADIO
 3. PHONE
 4. TTY
 5. IN PERSON
 6. ON VIEW
 7. OFF. OFF DUTY
 8. C.B. RADIO
 9. OTHER

22. TYPE OF REPORT
 1. INCIDENT
 2. ACCIDENT
 3. CITATION
 4. NONE

23. STATUS
 1. UNFOUNDED
 2. PNL
 3. OTHER
 4. CLEARED
 5. EXCEPT CLEARED

24. DATE CLEARED **103 10 1999**

25. OFFENSE TYPE
 1. ADULT NA
 2. JUVENILE
 3. UNKNOWN

14. REC'D	15. DISP	16. 10-23	17. 10-24
13. DAY			
<input checked="" type="checkbox"/> SUN		THU 5	
MON 2		FRI 6	
TUE 3		SAT 7	
WED 4			

39. (CODE S-SUSPECT W-WITNESS V-VICTIM O-OTHER)						
CODE	40. NAME-LAST	FIRST	MI	41. D.O.B.	42. ADDRESS	43. TELEPHONE
O	Rappel	Paul	T	[REDACTED]	[REDACTED] S. 13th St.	[REDACTED]

01-24-99 I, Deputy Jost, checked on the indicated vehicle. Damage does not match. *[Signature]* MJM

45. IF COMPLAINANT DIFFERENT THEN CALLER, ENTER NAME, ADDRESS, D.O.B., TELEPHONE.

46. IF CODE O (OTHER) IS USED IN FIELD #39, EXPLAIN.

INCIDENT REPORT: NOTE: IF SECTION 22 ABOVE HAS NUMBER 4 CHECKED, DO NOT GO BEYOND THIS LINE WITHOUT RECORDS SECTION BEING ADVISED, OR NO RECORD ENTRIES WILL BE MADE BELOW THIS LINE.

PROPERTY VALUE	26. PROPERTY	A. CURRENCY	B. JEWELRY	C. FURS CLOTHING	D. VEHICLE (LOCAL)	E. OFFICE EQUIPMENT	F. RADIO, TV CAMERAS	G. FIREARMS	H. HOUSE-HOLD GOODS
	STOLEN	\$	\$	\$	\$	\$	\$	\$	\$
	RECOVERED	\$	\$	\$	\$	\$	\$	\$	\$
	26. PROPERTY	I. CONSUMABLES	J. LIVESTOCK	K. DRUGS	L. MARINE ITEMS	M. CONSTRUCTION ITEMS	N. LAWN AND GARDEN	O. SPORTING GOODS	P. MISC BICYCLE
	STOLEN	\$	\$	\$	\$	\$	\$	\$	\$
	RECOVERED	\$	\$	\$	\$	\$	\$	\$	\$

27. PROPERTY RECOVERED: LOCALLY _____ OTHER JURISDICTION _____ (INSERT O OR L)

PROPERTY ITEMIZATION	PROPERTY STOLEN/RECOVERED ITEMIZATION, USE THE FOLLOWING FORMAT				
	28. QUANTITY	29. ARTICLE NAME	30. BRAND NAME	31. SERIAL NUMBER	32. CODE
					S R <input type="checkbox"/> <input type="checkbox"/>
					S R <input type="checkbox"/> <input type="checkbox"/>
					S R <input type="checkbox"/> <input type="checkbox"/>
					S R <input type="checkbox"/> <input type="checkbox"/>
					S R <input type="checkbox"/> <input type="checkbox"/>

33. PROPERTY DAMAGE AMOUNT \$ _____ 34. INSURANCE COMPANY _____

35. OFFICER ASSAULTED Y N 36. ARSON Y N 37. STRUCTURE CODE _____ 38. DAMAGE \$ _____

47. CIB	ENTERED <input type="checkbox"/>	CANCELLED <input type="checkbox"/>	48. TOTAL AMOUNT PROPERTY STOLEN \$ _____
NCIC	<input type="checkbox"/>	<input type="checkbox"/>	
OTHER BROADCAST	<input type="checkbox"/>	<input type="checkbox"/>	
			49. TOTAL AMOUNT PROPERTY RECOVERED \$ _____

50. IS REPORT CONTINUED? YES NO

51. CAUTION INDICATORS, ATLS ETC.

52. DATA PROCESS INFORMATION:

COMPUTER ENTERED DATE 3/8/99
 MICROFILM INDEXED INITIAL RS

53. FILE APPROVAL

BY RS DATE 03/08/99

IS CASE CLASSIFICATION CORRECT? N
 IF N HAS CORRECTION BEEN MADE? N

INCIDENT CARD

4. INCIDENT *CS/S99-00242*

5. INCIDENT LOCATION
Shelb. Co - NW Corner of J+E

6. NAME- LAST-FIRST-MI
Anonymous (2)

7. D.O.B.

8. ADDRESS

9. TX-HOME

11. CITY STATE ZIP

10. TX-BUSINESS

18. ASSIGNED *929*

19. REC. BY *941*

20. DIS. BY *?*

21. HOW REC'D.
1. 911
2. POLICE RADIO
3. PHONE
4. TTY
5. IN PERSON
6. ON VIEW
7. OFF. OFF DUTY
8. C.B. RADIO
9. OTHER

22. TYPE OF REPORT
1. INCIDENT
2. ACCIDENT
3. CITATION
4. NONE

23. STATUS
1. UNFOUNDED
2. PNL
3. OTHER
4. CLEARED
5. EXCEPT CLEARED

24. DATE CLEARED *10308199*

25. OFFENSE TYPE
1. ADULT NA
2. JUVENILE
3. UNKNOWN

14. REC'D	15. DISP	16. 10-23	17. 10-24
13. DAY			
<i>SUN 1</i>	THU 5		
MON 2	FRI 6		
TUE 3	SAT 7		
WED 4			

12. DETAILS
Reports seeing a vehicle matching description of H+R vehicle at above location - no plates on veh. Sitting back in the yard.

39. (CODE S-SUSPECT W-WITNESS V-VICTIM O-OTHER)				41. D.O.B.		42. ADDRESS		43. TELEPHONE	
CODE	40. NAME-LAST	FIRST	MI						

I Sgt Schetter requested to have SBSO check above veh for us and have them get back to us.
G Schetter *[Signature]*

012499 @ 2105 hrs: SBSO dispatch phoned stating they had a deputy check at above location for vehicle. Vehicle on the property did not match description of the H&R suspect veh. 932/mh

45. IF COMPLAINANT DIFFERENT THEN CALLER, ENTER NAME, ADDRESS, D.O.B., TELEPHONE.

46. IF CODE O (OTHER) IS USED IN FIELD #39, EXPLAIN.

INCIDENT REPORT: NOTE: IF SECTION 22 ABOVE HAS NUMBER 4 CHECKED, DO NOT GO BEYOND THIS LINE WITHOUT RECORDS SECTION BEING ADVISED, OR NO RECORD ENTRIES WILL BE MADE BELOW THIS LINE.

PROPERTY VALUE	26. PROPERTY	A. CURRENCY	B. JEWELRY	C. FURS CLOTHING	D. VEHICLE (LOCAL)	E. OFFICE EQUIPMENT	F. RADIO, TV CAMERAS	G. FIREARMS	H. HOUSE-HOLD GOODS
	STOLEN	\$	\$	\$	\$	\$	\$	\$	\$
	RECOVERED	\$	\$	\$	\$	\$	\$	\$	\$
	26. PROPERTY	I. CONSUMABLES	J. LIVESTOCK	K. DRUGS	L. MARINE ITEMS	M. CONSTRUCTION ITEMS	N. LAWN AND GARDEN	O. SPORTING GOODS	P. MISC BICYCLE
	STOLEN	\$	\$	\$	\$	\$	\$	\$	\$
	RECOVERED	\$	\$	\$	\$	\$	\$	\$	\$

27. PROPERTY RECOVERED: LOCALLY _____ OTHER JURISDICTION _____ (INSERT O OR L)

PROPERTY ITEMIZATION	PROPERTY STOLEN/RECOVERED ITEMIZATION, USE THE FOLLOWING FORMAT				
	28. QUANTITY	29. ARTICLE NAME	30. BRAND NAME	31. SERIAL NUMBER	32. CODE
					S R <input type="checkbox"/> <input type="checkbox"/>
					S R <input type="checkbox"/> <input type="checkbox"/>
					S R <input type="checkbox"/> <input type="checkbox"/>
					S R <input type="checkbox"/> <input type="checkbox"/>
					S R <input type="checkbox"/> <input type="checkbox"/>

33. PROPERTY DAMAGE AMOUNT \$ _____ 34. INSURANCE COMPANY _____

35. OFFICER ASSAULTED Y N 36. ARSON Y N 37. STRUCTURE CODE _____ 38. DAMAGE \$ _____

47. CIB	ENTERED <input type="checkbox"/>	CANCELLED <input type="checkbox"/>	48. TOTAL AMOUNT PROPERTY STOLEN \$ _____
NCIC	<input type="checkbox"/>	<input type="checkbox"/>	
OTHER BROADCAST	<input type="checkbox"/>	<input type="checkbox"/>	
			49. TOTAL AMOUNT PROPERTY RECOVERED \$ _____

50. IS REPORT CONTINUED? YES NO 51. CAUTION INDICATORS, ATLS ETC.

52. DATA PROCESS INFORMATION:

COMPUTER ENTERED DATE 13.8.99

MICROFILM INDEXED INITIAL KS

IS CASE CLASSIFICATION CORRECT? Y N
IF N HAS CORRECTION BEEN MADE? Y N

53. FILE APPROVAL

BY KS DATE 03.08.99

399 14- 00700 10-24-99 MIPAD

4. INCIDENT CS | 599-00242

5. INCIDENT LOCATION Hwy JJ + S

6. NAME - LAST - FIRST - MI Anonymous | 7. D.O.B. | | |

8. ADDRESS | 9. TX-HOME | | |

11. CITY | STATE | ZIP | 10. TX-BUSINESS | | | |

12. DETAILS
Dark blue pick-up
RP # 80256F was seen
at above location at
1300 hrs. today.

INCIDENT CARD

18. ASSIGNED
Lt. Bushman 441
Jost 449
929
111

19. REC. BY 925 | 20. DIS. BY |

21. HOW REC'D.
1. 911
2. POLICE RADIO
3. PHONE
4. TTY
5. IN PERSON
6. ON VIEW
7. OFF. OFF DUTY
8. C.B. RADIO
9. OTHER

22. TYPE OF REPORT
1. INCIDENT
2. ACCIDENT
3. CITATION
4. NONE

23. STATUS
1. UNFOUNDED
2. PNL
3. OTHER
4. CLEARED
5. EXCEPT CLEARED

24. DATE CLEARED 108 108 199

25. OFFENSE TYPE
1. ADULT NA
2. JUVENILE
3. UNKNOWN

21A. M.O. | | | | |

14. REC'D	15. DISP	16. 10-23	17. 10-24
SUN	THU 5	MON 2	FRI 6
TUE 3	SAT 7	WED 4	

39. (CODE S-SUSPECT W-WITNESS V-VICTIM O-OTHER)

CODE	40. NAME-LAST	FIRST	MI	41. D.O.B.	42. ADDRESS	43. TELEPHONE

Grill was either black or gray in color, part of it was missing, there was other front end damage also. Vehicle described as "older", possibly mid 80's model, dark blue in color, no tailgate. Above info was immediately passed on to Deputy Jost. SE SE
 01-25-99 I, Deputy Jost, checked this vehicle along with two other trucks on the property neither of these vehicles matched the suspect vehicle. JMS JMJ

45. IF COMPLAINANT DIFFERENT THEN CALLER; ENTER NAME, ADDRESS, D.O.B., TELEPHONE.

46. IF CODE O (OTHER) IS USED IN FIELD #39, EXPLAIN.

INCIDENT REPORT: NOTE: IF SECTION 22 ABOVE HAS NUMBER 4 CHECKED, DO NOT GO BEYOND THIS LINE WITHOUT RECORDS SECTION BEING ADVISED, OR NO RECORD ENTRIES WILL BE MADE BELOW THIS LINE.

PROPERTY VALUE	26. PROPERTY	A. CURRENCY	B. JEWELRY	C. FURS CLOTHING	D. VEHICLE (LOCAL)	E. OFFICE EQUIPMENT	F. RADIO, TV CAMERAS	G. FIREARMS	H. HOUSE-HOLD GOODS
	STOLEN	\$	\$	\$	\$	\$	\$	\$	\$
	RECOVERED	\$	\$	\$	\$	\$	\$	\$	\$
	26. PROPERTY	I. CONSUM-ABLES	J. LIVESTOCK	K. DRUGS	L. MARINE ITEMS	M. CONSTRUCTION ITEMS	N. LAWN AND GARDEN	O. SPORTING GOODS	P. MISC BICYCLE
STOLEN	\$	\$	\$	\$	\$	\$	\$	\$	
RECOVERED	\$	\$	\$	\$	\$	\$	\$	\$	

27. PROPERTY RECOVERED: LOCALLY _____ OTHER JURISDICTION _____ (INSERT O OR L)

PROPERTY ITEMIZATION	PROPERTY STOLEN/RECOVERED ITEMIZATION, USE THE FOLLOWING FORMAT				
	28. QUANTITY	29. ARTICLE NAME	30. BRAND NAME	31. SERIAL NUMBER	32. CODE
					S R <input type="checkbox"/> <input type="checkbox"/>
					S R <input type="checkbox"/> <input type="checkbox"/>
					S R <input type="checkbox"/> <input type="checkbox"/>
					S R <input type="checkbox"/> <input type="checkbox"/>

33. PROPERTY DAMAGE AMOUNT \$ _____ 34. INSURANCE COMPANY _____

35. OFFICER ASSAULTED Y N 36. ARSON Y N 37. STRUCTURE CODE _____ 38. DAMAGE \$ _____

47. CIB	ENTERED <input type="checkbox"/>	CANCELLED <input type="checkbox"/>	48. TOTAL AMOUNT PROPERTY STOLEN \$ _____
NCIC	<input type="checkbox"/>	<input type="checkbox"/>	
OTHER BROADCAST	<input type="checkbox"/>	<input type="checkbox"/>	
			49. TOTAL AMOUNT PROPERTY RECOVERED \$ _____

50. IS REPORT CONTINUED? YES NO 51. CAUTION INDICATORS, ATLS ETC.

52. DATA PROCESS INFORMATION:

COMPUTER ENTERED DATE 3.8.99

MICROFILM INDEXED INITIAL KS

IS CASE CLASSIFICATION CORRECT? Y N
IF N HAS CORRECTION BEEN MADE? Y N

53. FILE APPROVAL
BY VP DATE 03/08/99

INCIDENT CARD

4. INCIDENT
CS/ 598-00242

5. INCIDENT LOCATION
Hwy CR + Silver Crk Rd.

6. NAME - LAST - FIRST - MI
Anonymous

7. D.O.B.

8. ADDRESS

9. TX-HOME

11. CITY STATE ZIP

10. TX-BUSINESS

18. ASSIGNED

Jost 449

Lt. Bushman 441

Sgt. Schetter 493

19. REC. BY 925

20. DIS. BY 925

21. HOW REC'D.
1. 911
2. POLICE RADIO
3. PHONE
4. TTY
5. IN PERSON
6. ON VIEW
7. OFF OFF DUTY
8. C.B. RADIO
9. OTHER

22. TYPE OF REPORT
1. INCIDENT
2. ACCIDENT
3. CITATION
4. NONE

23. STATUS
1. UNFOUNDED
2. PNL
3. OTHER
4. CLEARED
5. EXCEPT CLEARED

24. DATE CLEARED 03 08 99

25. OFFENSE TYPE
1. ADULT NA
2. JUVENILE
3. UNKNOWN

14. REC'D	15. DISP	16. 10-23	17. 10-24
13. DAY			
SUN 1	THU 5		
MON 2	FRI 6		
TUE 3	SAT 7		
WED 4			

12. DETAILS
At 0100 hrs. this morning complainant overheard a group of males at the Packer Inn,

39. (CODE S-SUSPECT W-WITNESS V-VICTIM O-OTHER)

CODE	40. NAME-LAST	FIRST	MI	41. D.O.B.	42. ADDRESS	43. TELEPHONE

Newton, that Kenneth Reichwaldt's 25 yoa son (name unknown), was the operator of above fatality. Father and son reportedly both reside at [redacted] Hwy F, across from Chizek Transport. Info was immediately given to Deputy Jost. SE SE
01-24-99 Checked the information, not a match. [Signature] JMJ

45. IF COMPLAINANT DIFFERENT THEN CALLER, ENTER NAME, ADDRESS, D.O.B., TELEPHONE.

46. IF CODE O (OTHER) IS USED IN FIELD #39, EXPLAIN.

INCIDENT REPORT: NOTE: IF SECTION 22 ABOVE HAS NUMBER 4 CHECKED, DO NOT GO BEYOND THIS LINE WITHOUT RECORDS SECTION BEING ADVISED, OR NO RECORD ENTRIES WILL BE MADE BELOW THIS LINE.

PROPERTY VALUE	26. PROPERTY	A. CURRENCY	B. JEWELRY	C. FURS CLOTHING	D. VEHICLE (LOCAL)	E. OFFICE EQUIPMENT	F. RADIO, TV CAMERAS	G. FIREARMS	H. HOUSE-HOLD GOODS
	STOLEN	\$	\$	\$	\$	\$	\$	\$	\$
	RECOVERED	\$	\$	\$	\$	\$	\$	\$	\$
	26. PROPERTY	I. CONSUMABLES	J. LIVESTOCK	K. DRUGS	L. MARINE ITEMS	M. CONSTRUCTION ITEMS	N. LAWN AND GARDEN	O. SPORTING GOODS	P. MISC BICYCLE
	STOLEN	\$	\$	\$	\$	\$	\$	\$	\$
	RECOVERED	\$	\$	\$	\$	\$	\$	\$	\$

27. PROPERTY RECOVERED: LOCALLY _____ OTHER JURISDICTION _____ (INSERT O OR L)

PROPERTY ITEMIZATION	PROPERTY STOLEN/RECOVERED ITEMIZATION, USE THE FOLLOWING FORMAT				
	28. QUANTITY	29. ARTICLE NAME	30. BRAND NAME	31. SERIAL NUMBER	32. CODE
					S R <input type="checkbox"/> <input type="checkbox"/>
					S R <input type="checkbox"/> <input type="checkbox"/>
					S R <input type="checkbox"/> <input type="checkbox"/>
					S R <input type="checkbox"/> <input type="checkbox"/>

33. PROPERTY DAMAGE AMOUNT \$ _____

34. INSURANCE COMPANY _____

35. OFFICER ASSAULTED Y N

36. ARSON Y N

37. STRUCTURE CODE _____ 38. DAMAGE \$ _____

47. CIB ENTERED CANCELLED
 NCIC
 OTHER BROADCAST

48. TOTAL AMOUNT PROPERTY STOLEN \$ _____

49. TOTAL AMOUNT PROPERTY RECOVERED \$ _____

50. IS REPORT CONTINUED? YES NO

51. CAUTION INDICATORS, ATLS ETC.

52. DATA PROCESS INFORMATION:

COMPUTER ENTERED DATE 3/8/99

MICROFILM INDEXED INITIAL [Signature]

IS CASE CLASSIFICATION CORRECT? Y N
 IF N HAS CORRECTION BEEN MADE? Y N

53. FILE APPROVAL

BY [Signature] DATE 03/8/99

S99 INC 00101 165P.11. 02994

4. INCIDENT **CS S99-00242**

5. INCIDENT LOCATION

6. NAME- LAST-FIRST-MI **Anonymous** 7. D.O.B. | | |

8. ADDRESS 9. TX-HOME

11. CITY STATE ZIP 10. TX-BUSINESS

12. DETAILS
Rec'd info re: fatal
in & r

14. REC'D	15. DISP	16. 10-23	17. 10-24
13. DAY			
SUN 1	THU 5		
MON 2	FRI 6		
TUE 3	SAT 7		
WED 4			

INCIDENT CARD

18. ASSIGNED **Michel 286**
929

19. REC. BY **921** 20. DIS. BY

22. TYPE OF REPORT
 1. INCIDENT
 2. ACCIDENT
 3. CITATION
 4. NONE

23. STATUS
 1. UNFOUNDED
 2. PNL
 3. OTHER
 4. CLEARED
 5. EXCEPT CLEARED

24. DATE CLEARED **10308 99**

25. OFFENSE TYPE
 1. ADULT NA
 2. JUVENILE
 3. UNKNOWN

39. (CODE S-SUSPECT W-WITNESS V-VICTIM O-OTHER)						
CODE	40. NAME-LAST	FIRST	MI	41. D.O.B.	42. ADDRESS	43. TELEPHONE
O	Reichwaldt, Philip C			156273	██████████ CTH C Mtwc, Wi	██████████

01/25/99: Information was relayed to me, Det. Michel, through an informant known to me that a friend of a friend of a friend's boyfriend, who's name was PHILIP, had been on CTH CR on the morning of the fatal accident and had returned to the friend's residence in a nervous condition, stating he thought he hit a deer. PHILIP is now scared and his truck is currently being hidden. JMMichel /bjc

03/04/99 1430hrs This complaint with others was brought to the S.C. office by K.Shoulak as it was still in the detectives files. The suspect listed above was checked thoroughly by Detectives Michel and Herrmann. And again on a second complaint by Off. Jost and LT O'Hearn. Close Out, M.J. Bushman

45. IF COMPLAINANT DIFFERENT THEN CALLER, ENTER NAME, ADDRESS, D.O.B., TELEPHONE.

46. IF CODE O (OTHER) IS USED IN FIELD #39, EXPLAIN.

INCIDENT REPORT: NOTE: IF SECTION 22 ABOVE HAS NUMBER 4 CHECKED, DO NOT GO BEYOND THIS LINE WITHOUT RECORDS SECTION BEING ADVISED, OR NO RECORD ENTRIES WILL BE MADE BELOW THIS LINE.

PROPERTY VALUE	26. PROPERTY	A. CURRENCY	B. JEWELRY	C. FURS CLOTHING	D. VEHICLE (LOCAL)	E. OFFICE EQUIPMENT	F. RADIO, TV CAMERAS	G. FIREARMS	H. HOUSE-HOLD GOODS
	STOLEN	\$	\$	\$	\$	\$	\$	\$	\$
	RECOVERED	\$	\$	\$	\$	\$	\$	\$	\$
	26. PROPERTY	I. CONSUM-ABLES	J. LIVESTOCK	K. DRUGS	L. MARINE ITEMS	M. CONSTRUCTION ITEMS	N. LAWN AND GARDEN	O. SPORTING GOODS	P. MISC BICYCLE
STOLEN	\$	\$	\$	\$	\$	\$	\$	\$	
RECOVERED	\$	\$	\$	\$	\$	\$	\$	\$	

27. PROPERTY RECOVERED: LOCALLY ____ OTHER JURISDICTION ____ (INSERT O OR L)

PROPERTY ITEMIZATION	PROPERTY STOLEN/RECOVERED ITEMIZATION, USE THE FOLLOWING FORMAT				
	28. QUANTITY	29. ARTICLE NAME	30. BRAND NAME	31. SERIAL NUMBER	32. CODE
					S R <input type="checkbox"/> <input type="checkbox"/>
					S R <input type="checkbox"/> <input type="checkbox"/>
					S R <input type="checkbox"/> <input type="checkbox"/>
					S R <input type="checkbox"/> <input type="checkbox"/>
					S R <input type="checkbox"/> <input type="checkbox"/>

33. PROPERTY DAMAGE AMOUNT \$ _____ 34. INSURANCE COMPANY _____

35. OFFICER ASSAULTED Y N 36. ARSON Y N 37. STRUCTURE CODE _____ 38. DAMAGE \$ _____

47. CIB NCIC OTHER BROADCAST	ENTERED	CANCELLED	48. TOTAL AMOUNT PROPERTY STOLEN \$ _____
	<input type="checkbox"/>	<input type="checkbox"/>	
	<input type="checkbox"/>	<input type="checkbox"/>	
			49. TOTAL AMOUNT PROPERTY RECOVERED \$ _____

50. IS REPORT CONTINUED? YES NO 51. CAUTION INDICATORS, ATLS ETC.

52. DATA PROCESS INFORMATION:

COMPUTER ENTERED DATE 3.8.99

MICROFILM INDEXED INITIAL KS

IS CASE CLASSIFICATION CORRECT? N

IF N HAS CORRECTION BEEN MADE? N

53. FILE APPROVAL

BY RP DATE 03.08.99

399 IV- 00700 10,510,11 11,410,11

4. INCIDENT
CS/S99-00242

5. INCIDENT LOCATION
CLOVER RD.

6. NAME - LAST - FIRST - MI
ANONYMOUS.

7. D.O.B.

8. ADDRESS
9. TX-HOME

11. CITY STATE ZIP
10. TX-BUSINESS

12. DETAILS
RUSTY ORANGE CHEV P/U, EARLY 80'S,
W/BLUE TARP OVER IT PARKED BY BLUE
TRAILER HOUSE - HAS BEEN THERE COVERED
UP FOR ABOUT A WEEK.

INCIDENT CARD

18. ASSIGNED
MISO 91219
PMT 1149

19. REC. BY 932
20. DIS. BY 932

22. TYPE OF REPORT
① INCIDENT
2. ACCIDENT
3. CITATION
4. NONE

21. HOW REC'D.
1. 911
2. POLICE RADIO
③ 3. PHONE
4. TTY
5. IN PERSON
6. ON VIEW
7. OFF. OFF DUTY
8. C.B. RADIO
9. OTHER

23. STATUS
1. UNFOUNDED
2. PNL
③ 3. OTHER
4. CLEARED
5. EXCEPT CLEARED

24. DATE CLEARED 103 08 199

25. OFFENSE TYPE
1. ADULT NA
2. JUVENILE
3. UNKNOWN

14. REC'D	15. DISP	16. 10-23	17. 10-24
13. DAY			
SUN 1	THU 5		
MON ②	FRI 6		
TUE 3	SAT 7		
WED 4			

39. (CODE S-SUSPECT W-WITNESS V-VICTIM O-OTHER)				42. ADDRESS		43. TELEPHONE
CODE	40. NAME-LAST	FIRST	MI	41. D.O.B.		

01-25-99 I, Deputy Jost, made contact with the resident at the above location. The two vehicles that were mentioned did not match our suspect vehicle. *Jost MJ*

399 IV- 00751 16,510,11 11401,1

4. INCIDENT
CS/S99-00242

5. INCIDENT LOCATION
STH CR

6. NAME LAST-FIRST-MI
[REDACTED] 7. D.O.B.
[REDACTED]

8. ADDRESS
[REDACTED] 9. TX-HOME
[REDACTED]

11. CITY STATE ZIP
[REDACTED] 10. TX-BUSINESS
[REDACTED]

12. DETAILS
SAW BLUE 80'S BLAZER, GRAY PANEL
SIDES WITH BUSTED OUT GRILL &
DENT IN PASS. SIDE ABOVE WHEEL
THAT HAD "OUCH" PAINTED OVER IT IN

INCIDENT CARD

18. ASSIGNED
SBSO 9138
MTSO 9129
Bushman H.H.

19. REC. BY 932 20. DIS. BY 932

22. TYPE OF REPORT
① INCIDENT
2. ACCIDENT
3. CITATION
4. NONE

21. HOW REC'D.
1. 911
2. POLICE RADIO
③ 3. PHONE
4. TTY
5. IN PERSON
6. ON VIEW
7. OFF. OFF DUTY
8. C.B. RADIO
9. OTHER

23. STATUS
1. UNFOUNDED
2. PNL
③ 3. OTHER
4. CLEARED
5. EXCEPT CLEARED

24. DATE CLEARED 10308 99

25. OFFENSE TYPE
1. ADULT NA
2. JUVENILE
3. UNKNOWN

14. REC'D	15. DISP	16. 10-23	17. 10-24
13. DAY			
SUN 1	THU 5		
MON ②	FRI 6		
TUE 3	SAT 7		
WED 4			

39. (CODE S-SUSPECT W-WITNESS V-VICTIM O-OTHER)	40. NAME-LAST	FIRST	MI	41. D.O.B.	42. ADDRESS	43. TELEPHONE

orange. Partial plate on Blazer is TDE---. It was seen off Taylor Drive in the parking lot of a gas station/McDonald's around 1530 hrs today. Caller stated the driver was a f/w, about 30 years of age with sandy brown hair. TTY was sent to Sheboygan PD and Sheboygan County Sheriff's Dept. to attempt to locate. TTY is attached. 932/mh

Photographs of the vehicle described above arrived from Sheboygan County Sheriff Department. They were taken of the above which was a Chev S-10 Blazer in very poor condition. If vehicle was not confirmed to be a full size truck chassis this would be a strong possibility, however vehicle size is no match. M.J.Bushman
Thank you for the assist Sheboygan.

45. IF COMPLAINANT DIFFERENT THEN CALLER, ENTER NAME, ADDRESS, D.O.B., TELEPHONE.

46. IF CODE O (OTHER) IS USED IN FIELD #39, EXPLAIN.

INCIDENT REPORT: NOTE: IF SECTION 22 ABOVE HAS NUMBER 4 CHECKED, DO NOT GO BEYOND THIS LINE WITHOUT RECORDS SECTION BEING ADVISED, OR NO RECORD ENTRIES WILL BE MADE BELOW THIS LINE.

PROPERTY VALUE	26. PROPERTY	A. CURRENCY	B. JEWELRY	C. FURS CLOTHING	D. VEHICLE (LOCAL)	E. OFFICE EQUIPMENT	F. RADIO, TV CAMERAS	G. FIREARMS	H. HOUSE-HOLD GOODS
	STOLEN	\$	\$	\$	\$	\$	\$	\$	\$
	RECOVERED	\$	\$	\$	\$	\$	\$	\$	\$
	26. PROPERTY	I. CONSUM-ABLES	J. LIVESTOCK	K. DRUGS	L. MARINE ITEMS	M. CONSTRUCTION ITEMS	N. LAWN AND GARDEN	O. SPORTING GOODS	P. MISC BICYCLE
	STOLEN	\$	\$	\$	\$	\$	\$	\$	\$
	RECOVERED	\$	\$	\$	\$	\$	\$	\$	\$

27. PROPERTY RECOVERED: LOCALLY _____ OTHER JURISDICTION _____ (INSERT O OR L)

PROPERTY ITEMIZATION	PROPERTY STOLEN/RECOVERED ITEMIZATION, USE THE FOLLOWING FORMAT				
	28. QUANTITY	29. ARTICLE NAME	30. BRAND NAME	31. SERIAL NUMBER	32. CODE
					S R <input type="checkbox"/> <input type="checkbox"/>
					S R <input type="checkbox"/> <input type="checkbox"/>
					S R <input type="checkbox"/> <input type="checkbox"/>
					S R <input type="checkbox"/> <input type="checkbox"/>
					S R <input type="checkbox"/> <input type="checkbox"/>

33. PROPERTY DAMAGE AMOUNT \$ _____ 34. INSURANCE COMPANY _____

35. OFFICER ASSAULTED Y N 36. ARSON Y N 37. STRUCTURE CODE _____ 38. DAMAGE \$ _____

47. CIB	ENTERED <input type="checkbox"/>	CANCELLED <input type="checkbox"/>	48. TOTAL AMOUNT PROPERTY STOLEN \$ _____
NCIC	<input type="checkbox"/>	<input type="checkbox"/>	
OTHER BROADCAST	<input type="checkbox"/>	<input type="checkbox"/>	
			49. TOTAL AMOUNT PROPERTY RECOVERED \$ _____

50. IS REPORT CONTINUED? YES NO 51. CAUTION INDICATORS, ATLS ETC.

52. DATA PROCESS INFORMATION:

COMPUTER ENTERED DATE 3/19/99

MICROFILM INDEXED INITIAL AS

IS CASE CLASSIFICATION CORRECT? N

IF N HAS CORRECTION BEEN MADE? N

53. FILE APPROVAL

BY [Signature] DATE 03/08/99

333 17- 00134 1631011 114114

4. INCIDENT
CS/S99-00242

5. INCIDENT LOCATION
[REDACTED] CR

6. NAME - LAST - FIRST - MI
ANONYMOUS

7. D.O.B.

8. ADDRESS

9. TX-HOME

10. TX-BUSINESS

11. CITY STATE ZIP

12. DETAILS
SOLD 1978 GMC VAN TO MALE AT
[REDACTED] CR. HE WANTED VAN ENGINE
FOR FULL SIZE PICK UP TRUCK (LATE 80'S)
RESIDENCE IS A TRAILER W/ 30x60 GARAGE

INCIDENT CARD

18. ASSIGNED
MTSO
Glaeser 9/29
11/17

19. REC. BY
939

20. DIS. BY

22. TYPE OF REPORT
① INCIDENT
② ACCIDENT
③ CITATION
④ NONE

21. HOW REC'D.
1. 911
2. POLICE RADIO
③ 3. PHONE
4. TTY
5. IN PERSON
6. ON VIEW
7. OFF. OFF DUTY
8. C.B. RADIO
9. OTHER

23. STATUS
1. UNFOUNDED
2. PNL
③ 3. OTHER
4. CLEARED
5. EXCEPT CLEARED

24. DATE CLEARED 103 08 199

25. OFFENSE TYPE
1. ADULT NA
2. JUVENILE
3. UNKNOWN

14. REC'D	15. DISP	16. 10-23	17. 10-24
13. DAY			
SUN 1	THU 5		
① MON 2	FRI 6		
TUE 3	SAT 7		
WED 4			

39. (CODE S-SUSPECT W-WITNESS V-VICTIM O-OTHER)						
CODE	40. NAME-LAST	FIRST	MI	41. D.O.B.	42. ADDRESS	43. TELEPHONE
0	SCHMITZ LEE A			65903	[REDACTED] Scheffler Road Newton WI	[REDACTED]

01-25-99 I, Deputy Jost, attempted contact at the above address, no one home, and no vehicles in the yard. JMJ

01/28/99 1100 Hrs Deputy Glaeser checked the address at [REDACTED] CIH CR and found no one at home. No vehicles were observed in the driveway or near the house trailer. Attempt will have to be made by other officers. EJG

01/29/99 @ 0640Hrs I Deputy E. Glaeser attempted contact with the party listed in the reverse directory at the address of [REDACTED] CIH CR. I met with negative results and was informed that number was disconnected. I traveled to the residence to check it again and found it to be dark and no cars around. Contact was made with the next door neighbor who did provide the owners name of LEE SCHMITZ of the Newton area.

An inhouse records check provided an address and phone number for Schmitz and arrangements were made for the party to meet me at the trailer house before noon on this date.

01/29/99 @ 0910 Hrs Deputy Glaeser contacted Lee Schmitz at [REDACTED] Cth CR and questioned him in refference this crimestoppers repoert. Schmitz said he was the owner of the property and had been renting the trailer to a RANDY BERGENE untill December 15th, 1998. Schmitz said the trailer has been empty since then.

Lee Schmitz was asked if he has any trucks stored on the property and he stated he did have his 1969 Chevy truck stored in the garage and agreed to show me the vehicle. The truck was a 1969 Chevy C-10 pick-up colored TAN with a WHITE front and rear bumper. INSpecting the truck I found the grill and front end to NOT BE DAMAGED and in original condition. SCHMITZ was thanked for his cooperation. EJG This vehicle can be eliminated.

45. IF COMPLAINANT DIFFERENT THEN CALLER, ENTER NAME, ADDRESS, D.O.B., TELEPHONE.

46. IF CODE Q (OTHER) IS USED IN FIELD #39, EXPLAIN.

INCIDENT REPORT: NOTE: IF SECTION 22 ABOVE HAS NUMBER 4 CHECKED, DO NOT GO BEYOND THIS LINE WITHOUT RECORDS SECTION BEING ADVISED, OR NO RECORD ENTRIES WILL BE MADE BELOW THIS LINE.

PROPERTY VALUE	26. PROPERTY	A. CURRENCY	B. JEWELRY	C. FURS CLOTHING	D. VEHICLE (LOCAL)	E. OFFICE EQUIPMENT	F. RADIO, TV CAMERAS	G. FIREARMS	H. HOUSE-HOLD GOODS
	STOLEN	\$	\$	\$	\$	\$	\$	\$	\$
	RECOVERED	\$	\$	\$	\$	\$	\$	\$	\$
	26. PROPERTY	I. CONSUMABLES	J. LIVESTOCK	K. DRUGS	L. MARINE ITEMS	M. CONSTRUCTION ITEMS	N. LAWN AND GARDEN	O. SPORTING GOODS	P. MISC BICYCLE
	STOLEN	\$	\$	\$	\$	\$	\$	\$	\$
	RECOVERED	\$	\$	\$	\$	\$	\$	\$	\$

27. PROPERTY RECOVERED: LOCALLY _____ OTHER JURISDICTION _____ (INSERT O OR L)

PROPERTY ITEMIZATION	PROPERTY STOLEN/RECOVERED ITEMIZATION, USE THE FOLLOWING FORMAT				
	28. QUANTITY	29. ARTICLE NAME	30. BRAND NAME	31. SERIAL NUMBER	32. CODE
					S R <input type="checkbox"/> <input type="checkbox"/>
					S R <input type="checkbox"/> <input type="checkbox"/>
					S R <input type="checkbox"/> <input type="checkbox"/>
					S R <input type="checkbox"/> <input type="checkbox"/>
					S R <input type="checkbox"/> <input type="checkbox"/>

33. PROPERTY DAMAGE AMOUNT \$ _____

34. INSURANCE COMPANY _____

35. OFFICER ASSAULTED Y N 36. ARSON Y N 37. STRUCTURE CODE _____ 38. DAMAGE \$ _____

47. CIB ENTERED CANCELLED
 NCIC
 OTHER BROADCAST

48. TOTAL AMOUNT PROPERTY STOLEN \$ _____

49. TOTAL AMOUNT PROPERTY RECOVERED \$ _____

50. IS REPORT CONTINUED? YES NO

51. CAUTION INDICATORS, ATLS ETC.

52. DATA PROCESS INFORMATION:

COMPUTER ENTERED DATE 3/8/99

MICROFILM INDEXED INITIAL KS

IS CASE CLASSIFICATION CORRECT? N
 IF N HAS CORRECTION BEEN MADE? N

53. FILE APPROVAL

BY KR

DATE 03/08/99

599 IV 00130 10,310,11 10,17,000

4. INCIDENT
CS/599-00242

5. INCIDENT LOCATION

6. NAME - LAST - FIRST - MI

7. D.O.B.

8. ADDRESS

9. TX-HOME

11. CITY STATE ZIP

10. TX-BUSINESS

12. DETAILS
Provided info. listed
Below Ref. Fatal HHR
10-50.

14. REC'D.	15. DISP	16. 10-23	17. 10-24
13. DAY			
SUN 1	THU 5		
MON 2	FRI 6		
TUE 3	SAT 7		
WED 4			

INCIDENT CARD

18. ASSIGNED
MTSO 91249
Schetter 493

19. REC. BY 932

20. DIS. BY 932

21. HOW REC'D.
1. 911
2. POLICE RADIO
3. PHONE
4. TTY
5. IN PERSON
6. ON VIEW
7. OFF. OFF DUTY
8. C.B. RADIO
9. OTHER

22. TYPE OF REPORT
1. INCIDENT
2. ACCIDENT
3. CITATION
4. NONE

23. STATUS
1. UNFOUNDED
2. PNL
3. OTHER
4. CLEARED
5. EXCEPT CLEARED

24. DATE CLEARED 08/08/99

25. OFFENSE TYPE
1. ADULT
2. JUVENILE
3. UNKNOWN

39. (CODE S-SUSPECT W-WITNESS V-VICTIM O-OTHER)					42. ADDRESS		43. TELEPHONE
CODE	40. NAME-LAST	FIRST	MI	41. D.O.B.			

On 01-25-99 at 1900hrs a anonymous party came to MTSO and provided the following information ref. 10-50 fatal on Cth CR.

A Chuck Steinke who works 2nd shift at K.I.(3pm-11pm) had a conversation with a male hispanic name unknown. The male Hispanic apparently made comments to the fact he has a truck in his garage. The other comment made was that the male Hispanic " needs to get out of town for awhile"

At this point the party doesnt know the name of the male Hispanic but heard that the subject hasnt gone to work for the last four days.

Chuck Steinke also would not know the male Hispanic but was going to attempt to learn the Identity of this person.

I Sgt Schetter learned that a contact person at K.I. would be Human Resource Manager Jo Anne Jones at [redacted]. This officer will make contact at K.I. on 01-26-99 and try to confirm this information.

G Schetter

Sgt Hermann recieved a call from informant stating that she was informed that they believe this is the person responsible and want info passed along.

I Sgt Schetter spoke with Det Michels who also recieved information that this same person may be a suspect in this matter. Det. Michels learned that the suspect would be I.D. as Kevin Seal, considered a male indian. We will follow up on this together.

On 01-26-99 I spoke with Human Resources Div at K.I. and confirmed that they have a employee I.D. as Kevin Seal. They also confirmed that Mr Seal has not shown up for work since last Weds. 01-20-99. K.I. has not heard from Mr Seal since Weds and do not know as to why he hasnt called or came to work.

This officer did recieve the lastest address of [redacted] State st MIWC with Ph# of [redacted] for Mr Seal.

G Schetter

01-26-99 at 1350hrs Det Michel check the address of [redacted] State st and noted that the vehicle owned by Mr Seal does not match nor does it match vehicle were looking for. No further action needed unless something else would come forward to show more evidence. CJ

45. IF COMPLAINANT DIFFERENT THEN CALLER, ENTER NAME, ADDRESS, D.O.B., TELEPHONE.

46. IF CODE O (OTHER) IS USED IN FIELD #39, EXPLAIN.

INCIDENT REPORT:

NOTE: IF SECTION 22 ABOVE HAS NUMBER 4 CHECKED, DO NOT GO BEYOND THIS LINE WITHOUT RECORDS SECTION BEING ADVISED, OR NO RECORD ENTRIES WILL BE MADE BELOW THIS LINE.

PROPERTY VALUE	26. PROPERTY	A. CURRENCY	B. JEWELRY	C. FURS CLOTHING	D. VEHICLE (LOCAL)	E. OFFICE EQUIPMENT	F. RADIO, TV CAMERAS	G. FIREARMS	H. HOUSE-HOLD GOODS
	STOLEN	\$	\$	\$	\$	\$	\$	\$	\$
	RECOVERED	\$	\$	\$	\$	\$	\$	\$	\$
	26. PROPERTY	I. CONSUMABLES	J. LIVESTOCK	K. DRUGS	L. MARINE ITEMS	M. CONSTRUCTION ITEMS	N. LAWN AND GARDEN	O. SPORTING GOODS	P. MISC BICYCLE
	STOLEN	\$	\$	\$	\$	\$	\$	\$	\$
	RECOVERED	\$	\$	\$	\$	\$	\$	\$	\$

27. PROPERTY RECOVERED: LOCALLY _____ OTHER JURISDICTION _____ (INSERT O OR L)

PROPERTY ITEMIZATION	PROPERTY STOLEN/RECOVERED ITEMIZATION, USE THE FOLLOWING FORMAT				
	28. QUANTITY	29. ARTICLE NAME	30. BRAND NAME	31. SERIAL NUMBER	32. CODE
					S R <input type="checkbox"/> <input type="checkbox"/>
					S R <input type="checkbox"/> <input type="checkbox"/>
					S R <input type="checkbox"/> <input type="checkbox"/>
					S R <input type="checkbox"/> <input type="checkbox"/>
					S R <input type="checkbox"/> <input type="checkbox"/>

33. PROPERTY DAMAGE AMOUNT \$ _____ 34. INSURANCE COMPANY _____

35. OFFICER ASSAULTED Y N 36. ARSON Y N 37. STRUCTURE CODE _____ 38. DAMAGE \$ _____

47. CIB	ENTERED <input type="checkbox"/>	CANCELLED <input type="checkbox"/>	48. TOTAL AMOUNT PROPERTY STOLEN \$ _____
NCIC	<input type="checkbox"/>	<input type="checkbox"/>	
OTHER BROADCAST	<input type="checkbox"/>	<input type="checkbox"/>	
			49. TOTAL AMOUNT PROPERTY RECOVERED \$ _____

50. IS REPORT CONTINUED? YES NO 51. CAUTION INDICATORS, ATLS ETC.

52. DATA PROCESS INFORMATION:

COMPUTER ENTERED DATE 3.8.99

MICROFILM INDEXED INITIAL AS

IS CASE CLASSIFICATION CORRECT? IF N HAS CORRECTION BEEN MADE? Y N

53. FILE APPROVAL

BY [Signature] DATE 03/08/99

599 INE 00001 1631011 1221000

INCIDENT CARD

4. INCIDENT
CS/S99-00242

5. INCIDENT LOCATION
Hwy Q

6. NAME - LAST - FIRST - MI
MTSO (46)

7. D.O.B.

8. ADDRESS

9. TX-HOME

10. TX-BUSINESS

11. CITY STATE ZIP

12. DETAILS
PROVIDED INFO FOR FATAL H&R

18. ASSIGNED
MTSO 91219
FROELICH 4116

19. REC. BY
939

20. DIS. BY

21. HOW REC'D.
1. 911
2. POLICE RADIO
3. PHONE
4. TTY
5. IN PERSON
6. ON VIEW
7. OFF. OFF DUTY
8. C.B. RADIO
9. OTHER

22. TYPE OF REPORT
1. INCIDENT
2. ACCIDENT
3. CITATION
4. NONE

23. STATUS
1. UNFOUNDED
2. PNL
3. OTHER
4. CLEARED
5. EXCEPT CLEARED

24. DATE CLEARED
103108199

25. OFFENSE TYPE
1. ADULT NA
2. JUVENILE
3. UNKNOWN

14. REC'D	15. DISP	16. 10-23	17. 10-24
13. DAY			
SUN 1	THU 5		
MON 2	FRI 6		
TUE 3	SAT 7		
WED 4			

39. (CODE S-SUSPECT W-WITNESS V-VICTIM O-OTHER)						
CODE	40. NAME-LAST	FIRST	MI	41. D.O.B.	42. ADDRESS	43. TELEPHONE
O	POSVIC	83773	MICHAEL	E	CTH Q, Two Rivers	

01/25/99: I, Deputy J. J. Froelich, was informed of this Crime Stopper report reference a possible suspect in the hit and run fatal. I responded to [redacted] CTH Q, Two Rivers, to speak with MICHAEL POSVIC. Information received was that POSVIC possibly was looking for body work to be done on a Chevy Blazer, unknown year. Information was passed on from Lt. Brotski of TRPD.

I met with POSVIC. He showed me an S series Blazer which was parked in the yard with no damage. POSVIC also allowed me to check the barns and garage on the property. No other vehicles were even close to the description of the suspect vehicle.

JJFroelich *[Signature]* /bjc

45. IF COMPLAINANT DIFFERENT THEN CALLER, ENTER NAME, ADDRESS, D.O.B., TELEPHONE.

46. IF CODE O (OTHER) IS USED IN FIELD #39, EXPLAIN.

INCIDENT REPORT: NOTE: IF SECTION 22 ABOVE HAS NUMBER 4 CHECKED, DO NOT GO BEYOND THIS LINE WITHOUT RECORDS SECTION BEING ADVISED, OR NO RECORD ENTRIES WILL BE MADE BELOW THIS LINE.

PROPERTY VALUE	26. PROPERTY	A. CURRENCY	B. JEWELRY	C. FURS CLOTHING	D. VEHICLE (LOCAL)	E. OFFICE EQUIPMENT	F. RADIO, TV CAMERAS	G. FIREARMS	H. HOUSE-HOLD GOODS
	STOLEN	\$	\$	\$	\$	\$	\$	\$	\$
	RECOVERED	\$	\$	\$	\$	\$	\$	\$	\$
	26. PROPERTY	I. CONSUM-ABLES	J. LIVESTOCK	K. DRUGS	L. MARINE ITEMS	M. CONSTRUCTION ITEMS	N. LAWN AND GARDEN	O. SPORTING GOODS	P. MISC BICYCLE
	STOLEN	\$	\$	\$	\$	\$	\$	\$	\$
	RECOVERED	\$	\$	\$	\$	\$	\$	\$	\$

27. PROPERTY RECOVERED: LOCALLY _____ OTHER JURISDICTION _____ (INSERT O OR L)

PROPERTY ITEMIZATION	PROPERTY STOLEN/RECOVERED ITEMIZATION, USE THE FOLLOWING FORMAT				
	28. QUANTITY	29. ARTICLE NAME	30. BRAND NAME	31. SERIAL NUMBER	32. CODE
					S R <input type="checkbox"/> <input type="checkbox"/>
					S R <input type="checkbox"/> <input type="checkbox"/>
					S R <input type="checkbox"/> <input type="checkbox"/>
					S R <input type="checkbox"/> <input type="checkbox"/>

33. PROPERTY DAMAGE AMOUNT \$ _____

34. INSURANCE COMPANY _____

35. OFFICER ASSAULTED Y N 36. ARSON Y N 37. STRUCTURE CODE _____ 38. DAMAGE \$ _____

47. CIB ENTERED CANCELLED
 NCIC
 OTHER BROADCAST

48. TOTAL AMOUNT PROPERTY STOLEN \$ _____

49. TOTAL AMOUNT PROPERTY RECOVERED \$ _____

50. IS REPORT CONTINUED? YES NO

51. CAUTION INDICATORS, ATLS ETC.

52. DATA PROCESS INFORMATION:

COMPUTER ENTERED DATE 13/8/99
 MICROFILM INDEXED INITIAL KS

53. FILE APPROVAL

IS CASE CLASSIFICATION CORRECT? Y N
 IF N HAS CORRECTION BEEN MADE? Y N

BY KS DATE 13/08/99

1005

Lt. Bertschi got a call
from [REDACTED]

a Michael Posvic

[REDACTED] 83773

called to request a quote
for some front end
body work on a Chevy
Blazer, unknown year.

Caller wanted a phone
quote, would not bring
vehicle in.

Cathy / 941

599 INE 00000 16310,11 15,210,00

4. INCIDENT CS/S99-00242

5. INCIDENT LOCATION CTH CR

6. NAME LAST FIRST MI [REDACTED] A. 64378 [REDACTED] D.O.B. [REDACTED]

8. ADDRESS [REDACTED] 9. TX-HOME [REDACTED]

11. CITY [REDACTED] STATE [REDACTED] ZIP [REDACTED] 10. TX-BUSINESS [REDACTED]

12. DETAILS Reports truck for sale on corner of Meadow Ln + Lindburg Sts. blue p.v. w/ duct taped grill on passenger side.

14. REC'D 15. DISP 16. 10-23 17. 10-24
13. DAY
SUN 1 THU 5
MON 2 FRI 6
TUE 3 SAT 7
WED 4

INCIDENT CARD

18. ASSIGNED HNT
MTSO C.S. 929
||
||

19. REC. BY 923 20. DIS. BY
22. TYPE OF REPORT
1. INCIDENT
2. ACCIDENT
3. CITATION
4. NONE
23. STATUS
1. UNFOUNDED
2. PNL
3. OTHER
4. CLEARED
5. EXCEPT CLEARED
24. DATE CLEARED 03/16/89
25. OFFENSE TYPE
1. ADULT NA
2. JUVENILE
3. UNKNOWN
21. HOW REC'D.
1. 911
2. POLICE RADIO
3. PHONE
4. TTY
5. IN PERSON
6. ON VIEW
7. OFF. OFF DUTY
8. C.B. RADIO
9. OTHER
21A. M.O.

Table with 5 columns: CODE, NAME-LAST, FIRST, MI, D.O.B., ADDRESS, TELEPHONE. Row 1: 39. (CODE S-SUSPECT W-WITNESS V-VICTIM O-OTHER)

There were numerous calls about this vehicle and it had been checked several times. I did check it myself and found it did not match description being the wrong year and high off the ground with large oversize tires. M.J. Bushman

HNT

45. IF COMPLAINANT DIFFERENT THEN CALLER, ENTER NAME, ADDRESS, D.O.B., TELEPHONE.

46. IF CODE O (OTHER) IS USED IN FIELD #39, EXPLAIN.

INCIDENT REPORT: NOTE: IF SECTION 22 ABOVE HAS NUMBER 4 CHECKED, DO NOT GO BEYOND THIS LINE WITHOUT RECORDS SECTION BEING ADVISED, OR NO RECORD ENTRIES WILL BE MADE BELOW THIS LINE.

PROPERTY VALUE	26. PROPERTY	A. CURRENCY	B. JEWELRY	C. FURS CLOTHING	D. VEHICLE (LOCAL)	E. OFFICE EQUIPMENT	F. RADIO, TV CAMERAS	G. FIREARMS	H. HOUSE-HOLD GOODS
	STOLEN	\$	\$	\$	\$	\$	\$	\$	\$
	RECOVERED	\$	\$	\$	\$	\$	\$	\$	\$
	26. PROPERTY	I. CONSUMABLES	J. LIVESTOCK	K. DRUGS	L. MARINE ITEMS	M. CONSTRUCTION ITEMS	N. LAWN AND GARDEN	O. SPORTING GOODS	P. MISC BICYCLE
	STOLEN	\$	\$	\$	\$	\$	\$	\$	\$
	RECOVERED	\$	\$	\$	\$	\$	\$	\$	\$

27. PROPERTY RECOVERED: LOCALLY _____ OTHER JURISDICTION _____ (INSERT O OR L)

PROPERTY ITEMIZATION	PROPERTY STOLEN/RECOVERED ITEMIZATION, USE THE FOLLOWING FORMAT				
	28. QUANTITY	29. ARTICLE NAME	30. BRAND NAME	31. SERIAL NUMBER	32. CODE
					S R <input type="checkbox"/> <input type="checkbox"/>
					S R <input type="checkbox"/> <input type="checkbox"/>
					S R <input type="checkbox"/> <input type="checkbox"/>
					S R <input type="checkbox"/> <input type="checkbox"/>
					S R <input type="checkbox"/> <input type="checkbox"/>

33. PROPERTY DAMAGE AMOUNT \$ _____

34. INSURANCE COMPANY _____

35. OFFICER ASSAULTED Y N

36. ARSON Y N

37. STRUCTURE CODE _____

38. DAMAGE \$ _____

47. CIB ENTERED CANCELLED
 NCIC
 OTHER BROADCAST

48. TOTAL AMOUNT PROPERTY STOLEN \$ _____

49. TOTAL AMOUNT PROPERTY RECOVERED \$ _____

50. IS REPORT CONTINUED? YES NO

51. CAUTION INDICATORS, ATLS ETC.

52. DATA PROCESS INFORMATION:

COMPUTER ENTERED DATE 3.8.99
 MICROFILM INDEXED INITIAL KS

53. FILE APPROVAL

IS CASE CLASSIFICATION CORRECT? N
 IF N HAS CORRECTION BEEN MADE? Y

BY [Signature] DATE 03/16/99

1. CASE # **S99 No 00830** | 2. CLASSIFICATION **6310.11** | 3. CENSUS **521000**

4. INCIDENT **CS / S99-00-242**

5. INCIDENT LOCATION

6. NAME - LAST - FIRST - MI **Anonymous** | 7. D.O.B.

8. ADDRESS | 9. TX-HOME

11. CITY | STATE | ZIP | 10. TX-BUSINESS

12. DETAILS **See Attached.**

14. REC'D	15. DISP	16. 10-23	17. 10-24
13. DAY			
SUN 1	THU 5		
MON 2	FRI 6		
TUE 3	SAT 7		
WED 4			

MANITOWOC COUNTY SHERIFF INCIDENT CARD

18. ASSIGNED **MTSO** | **929**

NOVAK | **489**

19. REC. BY **935** | 20. DIS. BY **935**

21. HOW REC'D.
 1. 911
 2. POLICE RADIO
 3. PHONE
 4. TTY
 5. IN PERSON
 6. ON VIEW
 7. OFF. OFF DUTY
 8. C.B. RADIO
 9. OTHER
 21A. M.O.

22. TYPE OF REPORT
 1. INCIDENT
 2. ACCIDENT
 3. CITATION
 4. NONE
 23. STATUS
 1. UNFOUNDED
 2. PNL
 3. OTHER
 4. CLEARED
 5. EXCEPT CLEARED

24. DATE CLEARED **103108 1999**

25. OFFENSE TYPE
 1. ADULT NA
 2. JUVENILE
 3. UNKNOWN

39. (CODE S-SUSPECT W-WITNESS V-VICTIM O-OTHER)

CODE: 40. NAME-LAST | FIRST | MI | 41. D.O.B. | 42. ADDRESS | 43. TELEPHONE

0 | **Lehman** | **Kimberly** | **C** | [REDACTED] | **Waldo Blwi Manitowoc** |

01-26-99, 2200 hours, Deputy Novak met with Kimberly Lehman. Ms Lehman did show officer the vehicle in question. The vehicle, bearing WI RP GGR515 would not be the vehicle that was involved in the accident. R Novak

RN

45. IF COMPLAINANT DIFFERENT THEN CALLER, ENTER NAME, ADDRESS, D.O.B., TELEPHONE.

46. IF CODE O (OTHER) IS USED IN FIELD #39, EXPLAIN.

INCIDENT REPORT: NOTE: IF SECTION 22 ABOVE HAS NUMBER 4 CHECKED, DO NOT GO BEYOND THIS LINE WITHOUT RECORDS SECTION BEING ADVISED, OR NO RECORD ENTRIES WILL BE MADE BELOW THIS LINE.

PROPERTY VALUE	26. PROPERTY	A. CURRENCY	B. JEWELRY	C. FURS CLOTHING	D. VEHICLE (LOCAL)	E. OFFICE EQUIPMENT	F. RADIO, TV CAMERAS	G. FIREARMS	H. HOUSE HOLD GOOD
	STOLEN	\$	\$	\$	\$	\$	\$	\$	\$
	RECOVERED	\$	\$	\$	\$	\$	\$	\$	\$
	26. PROPERTY	I. CONSUMABLES	J. LIVESTOCK	K. DRUGS	L. MARINE ITEMS	M. CONSTRUCTION ITEMS	N. LAWN AND GARDEN	O. SPORTING GOODS	P. MISC BICYCLE
STOLEN	\$	\$	\$	\$	\$	\$	\$	\$	
RECOVERED	\$	\$	\$	\$	\$	\$	\$	\$	

27. PROPERTY RECOVERED: LOCALLY _____ OTHER JURISDICTION _____ (INSERT O OR L)

PROPERTY ITEMIZATION	PROPERTY STOLEN/RECOVERED ITEMIZATION, USE THE FOLLOWING FORMAT				
	28. QUANTITY	29. ARTICLE NAME	30. BRAND NAME	31. SERIAL NUMBER	32. CODE
					S R <input type="checkbox"/> <input type="checkbox"/>
					S R <input type="checkbox"/> <input type="checkbox"/>
					S R <input type="checkbox"/> <input type="checkbox"/>
					S R <input type="checkbox"/> <input type="checkbox"/>
					S R <input type="checkbox"/> <input type="checkbox"/>

33. PROPERTY DAMAGE AMOUNT \$ _____

34. INSURANCE COMPANY _____

35. OFFICER ASSAULTED Y N

36. ARSON Y N

37. STRUCTURE CODE _____

38. DAMAGE \$ _____

47. CIB ENTERED CANCELLED
 NCIC
 OTHER BROADCAST

48. TOTAL AMOUNT PROPERTY STOLEN \$ _____

49. TOTAL AMOUNT PROPERTY RECOVERED \$ _____

50. IS REPORT CONTINUED? YES NO

51. CAUTION INDICATORS, ATLS ETC.

52. DATA PROCESS INFORMATION:

COMPUTER ENTERED DATE 3/8/99
 MICROFILM INDEXED INITIAL KS
 IS CASE CLASSIFICATION CORRECT?
 IF N HAS CORRECTION BEEN MADE? Y N

53. FILE APPROVAL

BY RP

DATE 03/08/99

599 IN 0000 16,310,11, 17,010,00

4. INCIDENT **CS / 599-00242**

5. INCIDENT LOCATION **Green Bay**

6. NAME - LAST-FIRST-MI **GBPD - Officer Brickett** 7. D.O.B.

8. ADDRESS **1040** 9. TX-HOME

11. CITY STATE ZIP 10. TX-BUSINESS

12. DETAILS
 Rpts. stopping a grn older model
 Chev Blazer w/ extensive front
 end damage - no hood or grill.
 when questioned he was very

14. REC'D.	15. DISP	16. 10-23	17. 10-24
13. DAY			
SUN 1		THU 5	
MON 2		FRI 6	
TUE 3		SAT 7	
WED 4			

INCIDENT CARD

18. ASSIGNED **Lt. Bushman** **4/11/99**

19. REC. BY **93B** 20. DIS. BY

21. HOW REC'D.
 1. 911
 2. POLICE RADIO
 3. PHONE
 4. TTY
 5. IN PERSON
 6. ON VIEW
 7. OFF. OFF DUTY
 8. C.B. RADIO
 9. OTHER

22. TYPE OF REPORT
 1. INCIDENT
 2. ACCIDENT
 3. CITATION
 4. NONE

23. STATUS
 1. UNFOUNDED
 2. PNL
 3. OTHER
 4. CLEARED
 5. EXCEPT CLEARED

24. DATE CLEARED **103 08 199**

25. OFFENSE TYPE
 1. ADULT NA
 2. JUVENILE
 3. UNKNOWN

39. (CODE S-SUSPECT W-WITNESS V-VICTIM O-OTHER)						
CODE	40. NAME-LAST	FIRST	MI	41. D.O.B.	42. ADDRESS	43. TELEPHONE
O	ORLA-BUKOWSKI	FRANK	K		N Broadway St #25, Green Bay	54303

01-27-99 Con't...evasive. Subject is now staying at homeless shelter, but is from Greenleaf. Information was passed on to Lt. Bushman and he returned phone call for further info. GBPD Officer Brickett will forward report and photos. 938/KB KB

01/28/99: I, Deputy P. Herrmann, along with Lt. M. Bushman met with GBPD Officer S. Bickett at GBPD reference this incident. Officer Bickett directed Lt. Bushman and me to an apartment complex located on Broadway St in the City of Green Bay where we were able to make contact with FRANK ORLA-BUKOWSKI.

I introduced myself to ORLA-BUKOWSKI as a police office from MTSO. I asked ORLA-BUKOWSKI if he would be willing to answer questions regarding his whereabouts and damage to his vehicle to which he stated yes. I advised ORLA-BUKOWSKI he was not under arrest and was free to leave at any time he wished to which he stated he understood.

ORLA-BUKOWSKI stated he works at the shelter at this address in the kitchen on the weekends beginning at 1800 hours and working until midnight. This was verified through the shelter's work schedule. I asked ORLA-BUKOWSKI if he has ever traveled to Manitowoc or the Manitowoc area within the recent past to which he stated no. ORLA-BUKOWSKI stated his Chevy Blazer received extensive front end damage as a result of an accident in Stiles, WI, back in October or November 1998.

I found ORLA-BUKOWSKI to be cooperative and consistent with his explanation of the damages and his whereabouts on the night in question as it relates to this incident. ORLA-BUKOWSKI and his vehicle do not appear to be involved in this hit and run fatality.
 PHerrmann /bjc

45. IF COMPLAINANT DIFFERENT THEN CALLER, ENTER NAME, ADDRESS, D.O.B., TELEPHONE.

46. IF CODE O (OTHER) IS USED IN FIELD #39, EXPLAIN.

INCIDENT REPORT: NOTE: IF SECTION 22 ABOVE HAS NUMBER 4 CHECKED, DO NOT GO BEYOND THIS LINE WITHOUT RECORDS SECTION BEING ADVISED, OR NO RECORD ENTRIES WILL BE MADE BELOW THIS LINE.

PROPERTY VALUE	26. PROPERTY	A. CURRENCY	B. JEWELRY	C. FURS CLOTHING	D. VEHICLE (LOCAL)	E. OFFICE EQUIPMENT	F. RADIO, TV CAMERAS	G. FIREARMS	H. HOUSE-HOLD GOODS
	STOLEN	\$	\$	\$	\$	\$	\$	\$	\$
	RECOVERED	\$	\$	\$	\$	\$	\$	\$	\$
	26. PROPERTY	I. CONSUM-ABLES	J. LIVESTOCK	K. DRUGS	L. MARINE ITEMS	M. CONSTRUCTION ITEMS	N. LAWN AND GARDEN	O. SPORTING GOODS	P. MISC BICYCLE
	STOLEN	\$	\$	\$	\$	\$	\$	\$	\$
RECOVERED	\$	\$	\$	\$	\$	\$	\$	\$	

27. PROPERTY RECOVERED: LOCALLY _____ OTHER JURISDICTION _____ (INSERT O OR L)

PROPERTY ITEMIZATION	PROPERTY STOLEN/RECOVERED ITEMIZATION, USE THE FOLLOWING FORMAT				
	28. QUANTITY	29. ARTICLE NAME	30. BRAND NAME	31. SERIAL NUMBER	32. CODE
					S R <input type="checkbox"/> <input type="checkbox"/>
					S R <input type="checkbox"/> <input type="checkbox"/>
					S R <input checked="" type="checkbox"/> <input type="checkbox"/>
					S R <input type="checkbox"/> <input type="checkbox"/>
					S R <input type="checkbox"/> <input type="checkbox"/>

33. PROPERTY DAMAGE AMOUNT \$ _____ 34. INSURANCE COMPANY _____

35. OFFICER ASSAULTED Y N 36. ARSON Y N 37. STRUCTURE CODE _____ 38. DAMAGE \$ _____

47. CIB <input type="checkbox"/> ENTERED <input type="checkbox"/> CANCELLED <input type="checkbox"/> NCIC <input type="checkbox"/> OTHER BROADCAST <input type="checkbox"/>	48. TOTAL AMOUNT PROPERTY STOLEN \$ _____
	49. TOTAL AMOUNT PROPERTY RECOVERED \$ _____
	50. IS REPORT CONTINUED? YES NO

52. DATA PROCESS INFORMATION: COMPUTER ENTERED <input checked="" type="checkbox"/> DATE <u>13/8/99</u> MICROFILM INDEXED <input type="checkbox"/> INITIAL <u>AS</u> IS CASE CLASSIFICATION CORRECT? <input checked="" type="checkbox"/> Y N IF N HAS CORRECTION BEEN MADE? <input type="checkbox"/> Y N	51. CAUTION INDICATORS, ATLS ETC. 53. FILE APPROVAL BY <u>KP</u> DATE <u>03/08/99</u>
---	---

MTSO
599-00242

Working File - Copy
NEWS
18 99
FILE NAME

GREEN BAY POLICE DEPARTMENT
Detail Sheet

FILE # 99-05009 DATE 01-27-99

COMP/VICTIM Bickett TIME 4:16 p.m.
VIN: [REDACTED]

On Wednesday January 27, 1999 at 4:16 p.m. I was traveling southbound on S. Chestnut Ave from W. Walnut St, when I observed a green Chev K5 Blazer parked in front of the entrance/exit doors of West Side Liquor [REDACTED] W. Walnut St. The vehicle did not have a hood and had extensive front end damage. I recalled seeing a news report from the Manitowoc County Sheriff Department, that they were looking for an older Blazer type vehicle with heavy front end damage relating to a Hit and Run Homocide that happened several weeks ago. As I drove past the vehicle I observed a tan Wisconsin disabled plate on the front DIS2137. I turned into the parking lot where the vehicle was parked and pulled in a short distance behind the vehicle. I observed the rear plate on the vehicle was a Wisconsin truck plate AL47-479.

I was on a different call at the time I spotted this vehicle, I quickly tried to close the call and at the same time a male exited the liquor store and got into the passenger side of the vehicle. The vehicle left northbound on S. Chestnut Ave and turned westbound onto W. Walnut St. I followed the vehicle and as it turned North onto N. Ashland Ave, I radioed headquarters of my traffic stop and activated my red lights and siren. The vehicle stopped in the curb lane on N. Ashland just south of Hubbard St.

I told the driver I was pulling him over because he was driving without a hood and this was a violation of Trans.305 and also because He had two different plates on the vehicle. I asked him where his hood was and he told me it was getting repaired at a body shop. When I asked him what body shop he said it was none of my business. I then asked him why he had two different plates on the vehicle. He told me he just registered the vehicle and the plate on the back was his new one, he said he just didn't take the

L. Bickett 298
S. Bickett 298
Officer - GBPD

GREEN BAY POLICE DEPARTMENT
Detail Sheet

FILE # 99-05009 DATE 01-27-99

COMP/VICTIM Bickett TIME 4:16 p.m.

old one off the front. He gave me a Photo Wisconsin License identifying him as Frank K. Orla-Bukowski [REDACTED]. The address on his license was [REDACTED] Wayside Rd, Greenleaf, WI. I asked if that was his correct address. Orla said no that he moved to [REDACTED] N. Broadway, room #25 in Green Bay. I asked him how long ago and he told me it was none of my business.

I returned to my vehicle and when I did there was a message from Officer Weiss stating he stopped this same vehicle last week and Orla was warned for Improper display of registration plates. I asked Officer Weiss if he knew anything about the front end damage and Officer Weiss told me that he did not and that the damage was there when he stopped it last week. I wrote Orla a citation for Improper display of registration plates and a written warning for not having a hood on his vehicle. When I returned to the vehicle to give Orla his citation, warning and drivers license back I again asked him about the damage to his vehicle and he told me it was none of my business. He then drove away.

I contacted the Shift Commander Captain Secor and informed him of my suspicions and the demeanor of Orla. Captain Secor said to get Lieutenant Demro to meet me at [REDACTED] N. Broadway. Lieutenant Demro met me in the alley behind that address. I explained my suspicions about the vehicle and the demeanor of Orla. Lieutenant Demro photographed the vehicle. I observed the vehicle had square type headlights, one on each side. It is a 79 K5 Blazer. It does not have a hood emblem obviously because it has no hood. There is no front grill and the metal radiator support is bent in. There is no fan cover. The front bumper is indented in, in a very long type bend approximately 3 feet long. There is a sharp bend in the top of the framework where the grill would normally be. The drivers side market light is cracked out. The front windshield is missing

S. Bickett 298
S. Bickett 298
Officer - GBPD

GREEN BAY POLICE DEPARTMENT
Detail Sheet

FILE # 99-05009 DATE 01-27-99

COMP/VICTIM Bickett TIME 4:16 p.m.

the metal trim around the entire windshield. The tires are B.F. Goodrich radial tires with a good amount of tread. The photographs should show a distinct tread pattern. The front bumper is 12 to 14 inches off the ground and the license plate on the front is tan in color and has the same bend as the front bumper. I removed the plate as evidence.

I returned to the Police Station and contacted Lt. Bushman with Manitowoc County Sheriff Department. Lt. Bushman is in charge of their case. He stated he would be interested in seeing a copy of our case file and the photographs we have. This case has went unsolved in Manitowoc County since January 10th and Lt. Bushman states they have few leads. He did say there was small tan chips in the victims clothing, and that there is a distinct tire pattern and the tires are 7 1/4 wide from outside edge to inside edge.

I placed the License plate into evidence locker 14. I placed the photo card into the slot in Photo ID. I completed my details. Nothing further at this time.

S. Bickett 298

S. Bickett 298
Officer - GBPD

GREEN BAY POLICE DEPARTMENT
Detail Sheet

FILE # 99-05009 DATE 01-27-99

COMP/VICTIM Bickett TIME 4:16 p.m.

S. Bickett 298
S. Bickett 298
Officer - GBPD

Appearance Required No Yes Date: 03-11-99 2242399-3

PLACE: CIRCUIT MUNICIPAL Time: 8:30 am pm See back for court/point information
GREEN BAY MUNICIPAL COURT
S. ADAMS ST, GREEN BAY, WI 54301

4 For Court Use Only
2 DEPOSIT BAIL 3 ESTIMATE Points for This Citation
CASH CARD
\$ 42.30

42 Agency Space
99-05009
SQUAD 52

5 Non-Individual Name (Last, First, MI) ORLA-BUKOWSKI, FRANK K

6 Street Address Post Office State Zip
N. BROADWAY # 25 GREEN BAY WI 54303

7 Driver License Number/Identification Card Number (DL #00 #) State Exp. Yr. 8 HazMat No. 9 US DOT No.
WI 01

14 Sex Race HT. WT. Hair Eyes 15 Holds CDL 16 Operating as Class 17 Endorsements
M W 508 180 B B B L O YES (No) A B C D M O F H N P S T

19 Vehicle License Plate or VIN 20 Plate Type State Exp. Yr. 23 Vehicle Year, Make Type Color 24 Waiver
AL47-479 TRK WI 99 79 CHEV BLAZER GRN FAR FIR REC

1 State of WI 2 County 3 City 4 Village 5 Town 27 Defendant Violated 28 Adopting State Statute No.
GREEN BAY 29 Ord. No. 29 J9 341.15(3)

26 Plaintiff 29 Description of Violation 30 Overweight M 31 Actual Legal Over 32 Violation Zone:
GREEN BAY IMPROPER DISPLAY OF REGISTRATION PLATES P H CONST. RAILROAD SCHOOL

34 Week Day 35 Month - Day - Year 36 Time 37 County Name 38 CVT Code
WED 01-27-99 4:16 AM PM BROWN 56

39 On Hwy Street Name 40 Estimated Mileage 41 Front At Hwy Street Name
N. ASHLAND AVE 0 MI W N E At Hubbard St

43 Print Officer Name 44 Dept. 45 Officer ID No. 46 Date Citation Served 47 Accident Doc. No.
S. BICKETT GREEN BAY POLICE DEPT. 298 01-27-99

Wisconsin Uniform Citation MVA016 (498) 1 s.345.11, Wis. Stats. 49 Minor Passenger: YES NO By MAIL In PERSON Severity FATAL PI Pd

Green Bay Police Dept.
Traffic Division

NO. 24149

* PLEASE PRINT *

NOTICE: The vehicle (driver) described below is in violation of the Motor Vehicle Laws of Wisconsin as indicated. Any vehicle defect must be corrected at once and certification thereof secured from a Law Enforcement Officer. Mail or deliver this card, properly certified, to the address shown on the other side WITHIN FIVE DAYS to avoid court action without further notice in the City in which this ticket was issued.

INCIDENT # 99-05009 DATE 01-27-99 TIME 4:13 PM
VEH. MAKE: 79 CHEV BLAZ UC #: AL47-079

DRIVER: FRANK K. ORLA-BUKOWSKI
ADDRESS: N. BROADWAY # 25
DOB: DL #: 00

OWNER: SAME AS ABOVE
ADDRESS:

DESCRIPTION OF VIOLATION(S) / DEFECT(S):
* PLEASE PRINT *

VEH WITH OUT HOOD

LOCATION: N-Ashland / Hubbard

OFFICER: Bickett 298

SUBJECT	42. NAME (last, first, middle) J# _____ ID# _____						43. NAME (last, first, middle) J# _____ ID# _____							
	44. ADDRESS: (street, apt. #, city)				Phone # _____		45. ADDRESS (street, apt. #, city)				Phone # _____			
	46. DOB/Age	Sex	Race	Hgt.	Wgt.	Hair Color	Eyes	47. DOB/Age	Sex	Race	Hgt.	Wgt.	Hair Color	Eyes
	48. Clothing, facial hair, unusual features, speech, glasses						49. Clothing, facial hair, unusual features, speech, glasses							
	Statement? _____ Y _____ N						Statement? _____ Y _____ N							

50. Can suspect's/subject's vehicle be identified? If yes, place an "X" in the box at left. _____ Y _____ N

51. Year <u>89</u>	Make <u>CHEV</u>	Model <u>K-5 BLAZER</u>	Style <u>TRUCK</u>	Color: top/bottom <u>GREEN</u>
License # <u>AL47479</u>	State <u>WI</u>	Year <u>99</u>	Type <u>TRK</u>	Vin # _____
Identifying characteristics				

52. Quantity	Article type and brand name	Model #	Color	Serial #/owner applied	Est. value	Recovered
						Y/N

SEE OFFICER DETAILS.

Officer BICKETT Computer # J95

\$ _____ Theft \$ _____ Pocket Picking \$ _____ Purse Snatching \$ _____ Shoplifting \$ _____ From Coin Machines \$ _____ Auto Parts & Accessories \$ _____ From Autos, Not Parts \$ _____ From Buildings \$ _____ All Other	Residence Non-Residence Burglary (only) Value & Time Committed 8 AM - 6 PM 6 PM - 6 AM Time Not Known	\$ _____ \$ _____ \$ _____ \$ _____
--	---	--

Value of Property Stolen and Recovered

	Stolen	Recovered		Stolen	Recovered
Currency, Notes etc.	\$ _____	\$ _____	Firearms	\$ _____	\$ _____
Jewelry, Precious Metals	\$ _____	\$ _____	Household goods	\$ _____	\$ _____
Clothing, Furs	\$ _____	\$ _____	Consumable Goods	\$ _____	\$ _____
Office Equipment	\$ _____	\$ _____	Miscellaneous	\$ _____	\$ _____
TV's, Radios, Cameras	\$ _____	\$ _____		\$ _____	\$ _____

Final Review By: _____

DATE: 1-27-99 TIME: 455P
 REPORT#: 99-05009 CAMERA #: A4 CARD #: 2
 CONTENT OF PHOTOS: SLS VEH - HVR
 LOCATION: N. BROADWAY ST.
 PHOTOGRAPHER: L. DENVED COMPUTER #: E4
 THIS CASE TO BE REFERRED TO THE O.A.'S OFFICE YES

FRAME NOTES:

1	START CARD
2	FRONT PLATE
3	REAR PLATE
4	WHOLE FRONT VEH.
5	FRONT END DAMAGE
6	FRONT END DAMAGE
7	FRONT END DAMAGE
8	DRIVERS SIDE FRONT
9	PASSENGER SIDE
10	DRIVERS FRONT TIRE
11	
12	
13	
14	
15	
16	
17	
18	
19	
20	
21	
22	
23	
24	
25	
26	
27	
28	
29	
30	

599-00242

DATE: 1-27-99 TIME: 455P
REPORT# 99-05009 CAMERA# A4 CARD# 2
CONTENT OF PHOTOS: SUS VEH - HHR
LOCATION: N. BROADWAY ST
PHOTOGRAPHER Lt Demko COMPUTER# E4
THIS CASE TO BE REFERRED TO THE D.A.'S OFFICE YES.

FRAME: NOTES:

1	START CARD
2	FRONT PLATE
3	REAR PLATE
4	WHOLE FRONT VEH.
5	FRONT END DAMAGE
6	FRONT END DAMAGE
7	FRONT END DAMAGE
8	DRIVERS SIDE FRONT
9	PASSENGER SIDE
10	DRIVERS FRONT TIRE
11	
12	
13	
14	
15	
16	
17	
18	
19	
20	
21	
22	
23	
24	
25	
26	
27	
28	
29	
30	

S99 IN= 00000 6.310.11 15.210.0.0

4. INCIDENT CS / S99-00242

5. INCIDENT LOCATION MADISON ST - Nick's BAR

6. NAME - LAST - FIRST - MI ANONY. 7. D.O.B. (2)

8. ADDRESS _____ 9. TX-HOME _____

11. CITY _____ STATE _____ ZIP _____ 10. TX-BUSINESS _____

12. DETAILS
Rpts. A CHEV LP# CC 72450
w/ alot of front end damage.
would be Blu w/ white stripes. Also
HAS A REFRIGERATION UNIT ON BACK.

INCIDENT CARD

18. ASSIGNED MITSO 9129
HERMANN 41218

19. REC. BY 938 20. DIS. BY 938

21. HOW REC'D.
 1. 911
 2. POLICE RADIO
 3. PHONE
 4. CITY
 5. IN PERSON
 6. ON VIEW
 7. OFF. OFF DUTY
 8. C.B. RADIO
 9. OTHER

22. TYPE OF REPORT
 1. INCIDENT
 2. ACCIDENT
 3. CITATION
 4. NONE

23. STATUS
 1. UNFOUNDED
 2. PNL
 3. OTHER
 4. CLEARED
 5. EXCEPT CLEARED

24. DATE CLEARED 1310899

25. OFFENSE TYPE
 1. ADULT NA
 2. JUVENILE
 3. UNKNOWN

14. REC'D.	15. DISP.	16. 10-23	17. 10-24
13. DAY			
SUN 1	THU 5		
MON 2	FRI 6		
TUE 3	SAT 7		
WED 4			

39. (CODE S-SUSPECT W-WITNESS V-VICTIM O-OTHER)						
CODE	40. NAME-LAST	FIRST	MI	41. D.O.B.	42. ADDRESS	43. TELEPHONE

01-21-99 At time of call, DOT was down and dispatch was unable to run LP#. Rpt. was given to Deputy Hermann. LP# came back at 1557 hrs. and would be on a GMC, which would not match the suspect veh. 938/KB KB

45. IF COMPLAINANT DIFFERENT THEN CALLER, ENTER NAME, ADDRESS, D.O.B., TELEPHONE.

46. IF CODE O (OTHER) IS USED IN FIELD #39, EXPLAIN.

INCIDENT REPORT: NOTE: IF SECTION 22 ABOVE HAS NUMBER 4 CHECKED, DO NOT GO BEYOND THIS LINE WITHOUT RECORDS SECTION BEING ADVISED, OR NO RECORD ENTRIES WILL BE MADE BELOW THIS LINE.

PROPERTY VALUE	26. PROPERTY	A. CURRENCY	B. JEWELRY	C. FURS CLOTHING	D. VEHICLE (LOCAL)	E. OFFICE EQUIPMENT	F. RADIO, TV CAMERAS	G. FIREARMS	H. HOUSE-HOLD GOODS
	STOLEN	\$	\$	\$	\$	\$	\$	\$	\$
	RECOVERED	\$	\$	\$	\$	\$	\$	\$	\$
	26. PROPERTY	I. CONSUMABLES	J. LIVESTOCK	K. DRUGS	L. MARINE ITEMS	M. CONSTRUCTION ITEMS	N. LAWN AND GARDEN	O. SPORTING GOODS	P. MISC BICYCLE
	STOLEN	\$	\$	\$	\$	\$	\$	\$	\$
	RECOVERED	\$	\$	\$	\$	\$	\$	\$	\$

27. PROPERTY RECOVERED: LOCALLY _____ OTHER JURISDICTION _____ (INSERT O OR L)

PROPERTY ITEMIZATION	PROPERTY STOLEN/RECOVERED ITEMIZATION, USE THE FOLLOWING FORMAT				
	28. QUANTITY	29. ARTICLE NAME	30. BRAND NAME	31. SERIAL NUMBER	32. CODE
					S R <input type="checkbox"/> <input type="checkbox"/>
					S R <input type="checkbox"/> <input type="checkbox"/>
					S R <input type="checkbox"/> <input type="checkbox"/>
					S R <input type="checkbox"/> <input type="checkbox"/>

33. PROPERTY DAMAGE AMOUNT \$ _____

34. INSURANCE COMPANY _____

35. OFFICER ASSAULTED Y N

36. ARSON Y N

37. STRUCTURE CODE _____ 38. DAMAGE \$ _____

47. CIB ENTERED CANCELLED
 NCIC
 OTHER BROADCAST

48. TOTAL AMOUNT PROPERTY STOLEN \$ _____

49. TOTAL AMOUNT PROPERTY RECOVERED \$ _____

50. IS REPORT CONTINUED? YES NO

51. CAUTION INDICATORS, ATLS ETC.

52. DATA PROCESS INFORMATION:

COMPUTER ENTERED DATE 3/8/99

MICROFILM INDEXED INITIAL KS

IS CASE CLASSIFICATION CORRECT? N
 IF N HAS CORRECTION BEEN MADE? Y N

53. FILE APPROVAL

BY [Signature] DATE 3/8/99

399 IV-200001 1631011 B21000

INCIDENT CARD

4. INCIDENT **CS / 599-00242**

5. INCIDENT LOCATION **Galax Dr**

6. NAME- LAST-FIRST-MI **Anonymous (2)** 7. D.O.B.

8. ADDRESS 9. TX-HOME

11. CITY STATE ZIP 10. TX-BUSINESS

12. DETAILS **See Attached.**

18. ASSIGNED **MISO** **929**

19. REC. BY **935** 20. DIS. BY

21. HOW REC'D.
 1. 911
 2. POLICE RADIO
 3. PHONE
 4. TTY
 5. IN PERSON
 6. ON VIEW
 7. OFF. OFF DUTY
 8. C.B. RADIO
 9. OTHER

22. TYPE OF REPORT
 1. INCIDENT
 2. ACCIDENT
 3. CITATION
 4. NONE

23. STATUS
 1. UNFOUNDED
 2. PNL
 3. OTHER
 4. CLEARED
 5. EXCEPT CLEARED

24. DATE CLEARED **03/08/99**

25. OFFENSE TYPE
 1. ADULT NA
 2. JUVENILE
 3. UNKNOWN

14. REC'D	15. DISP	16. 10-23	17. 10-24
13. DAY			
SUN 1	THU 5		
MON 2	FRI 6		
TUE 3	SAT 7		
WED 4			

39. (CODE S-SUSPECT W-WITNESS V-VICTIM O-OTHER)

CODE	40. NAME- LAST CONJURSKI FIRST PAMELA MI A	41. D.O.B.	42. ADDRESS Galax Dr MtWC	43. TELEPHONE

1-21-99 checked, damage not consistent.

45. IF COMPLAINANT DIFFERENT THEN CALLER, ENTER NAME, ADDRESS, D.O.B., TELEPHONE.

46. IF CODE O (OTHER) IS USED IN FIELD #39, EXPLAIN.

INCIDENT REPORT: NOTE: IF SECTION 22 ABOVE HAS NUMBER 4 CHECKED, DO NOT GO BEYOND THIS LINE WITHOUT RECORDS SECTION BEING ADVISED, OR NO RECORD ENTRIES WILL BE MADE BELOW THIS LINE.

PROPERTY VALUE	26. PROPERTY	A. CURRENCY	B. JEWELRY	C. FURS CLOTHING	D. VEHICLE (LOCAL)	E. OFFICE EQUIPMENT	F. RADIO, TV CAMERAS	G. FIREARMS	H. HOUSE-HOLD GOODS
	STOLEN	\$	\$	\$	\$	\$	\$	\$	\$
	RECOVERED	\$	\$	\$	\$	\$	\$	\$	\$
	26. PROPERTY	I. CONSUM-ABLES	J. LIVESTOCK	K. DRUGS	L. MARINE ITEMS	M. CONSTRUCTION ITEMS	N. LAWN AND GARDEN	O. SPORTING GOODS	P. MISC BICYCLE
	STOLEN	\$	\$	\$	\$	\$	\$	\$	\$
	RECOVERED	\$	\$	\$	\$	\$	\$	\$	\$

27. PROPERTY RECOVERED: LOCALLY _____ OTHER JURISDICTION _____ (INSERT O OR L)

PROPERTY ITEMIZATION	PROPERTY STOLEN/RECOVERED ITEMIZATION, USE THE FOLLOWING FORMAT				31. SERIAL NUMBER	32. CODE		
	28. QUANTITY	29. ARTICLE NAME	30. BRAND NAME					
							S <input type="checkbox"/>	R <input type="checkbox"/>
							S <input type="checkbox"/>	R <input type="checkbox"/>
							S <input type="checkbox"/>	R <input type="checkbox"/>
							S <input type="checkbox"/>	R <input type="checkbox"/>

33. PROPERTY DAMAGE AMOUNT \$ _____

34. INSURANCE COMPANY _____

35. OFFICER ASSAULTED Y N

36. ARSON Y N

37. STRUCTURE CODE _____ 38. DAMAGE \$ _____

47. CIB ENTERED CANCELLED
 NCIC
 OTHER BROADCAST

48. TOTAL AMOUNT PROPERTY STOLEN \$ _____

49. TOTAL AMOUNT PROPERTY RECOVERED \$ _____

50. IS REPORT CONTINUED? YES NO

51. CAUTION INDICATORS, ATLS ETC.

52. DATA PROCESS INFORMATION:

COMPUTER ENTERED DATE 3.8.99
 MICROFILM INDEXED INITIAL KS

53. FILE APPROVAL

BY KR DATE 03.08.99

IS CASE CLASSIFICATION CORRECT? Y N
 IF N HAS CORRECTION BEEN MADE? Y N

000 11- 00007 10210.11 1921004

4. INCIDENT
CS / 599-00242

5. INCIDENT LOCATION

6. NAME - LAST - FIRST - MI
Anonymous (2)

7. D.O.B.

8. ADDRESS

9. TX-HOME

10. TX-BUSINESS

11. CITY STATE ZIP

12. DETAILS
See Attached.

INCIDENT CARD

18. ASSIGNED
MISO 929

19. REC. BY
935

20. DIS. BY

21. HOW REC'D.
1. 911
2. POLICE RADIO
3. PHONE
4. TTY
5. IN PERSON
6. ON VIEW
7. OFF. OFF DUTY
8. C.B. RADIO
9. OTHER

22. TYPE OF REPORT
1. INCIDENT
2. ACCIDENT
3. CITATION
4. NONE

23. STATUS
1. UNFOUNDED
2. PNL
3. OTHER
4. CLEARED
5. EXCEPT CLEARED

24. DATE CLEARED
03/08/99

25. OFFENSE TYPE
1. ADULT NA
2. JUVENILE
3. UNKNOWN

13. DAY
SUN 1 THU 5
MON 2 FRI 6
TUE 3 SAT 7
WED 4

39. (CODE S-SUSPECT W-WITNESS V-VICTIM O-OTHER)			
40. NAME-LAST	FIRST	MI	41. D.O.B.

01-21-99 vehicle checked by city 050 and damage is not consistant with what we are looking for. TJJ

45. IF COMPLAINANT DIFFERENT THEN CALLER, ENTER NAME, ADDRESS, D.O.B., TELEPHONE.

46. IF CODE O (OTHER) IS USED IN FIELD #39, EXPLAIN.

INCIDENT REPORT: NOTE: IF SECTION 22 ABOVE HAS NUMBER 4 CHECKED, DO NOT GO BEYOND THIS LINE WITHOUT RECORDS SECTION BEING ADVISED, OR NO RECORD ENTRIES WILL BE MADE BELOW THIS LINE.

PROPERTY VALUE	26. PROPERTY	A. CURRENCY	B. JEWELRY	C. FURS CLOTHING	D. VEHICLE (LOCAL)	E. OFFICE EQUIPMENT	F. RADIO, TV CAMERAS	G. FIREARMS	H. HOUSE-HOLD GOODS
	STOLEN	\$	\$	\$	\$	\$	\$	\$	\$
	RECOVERED	\$	\$	\$	\$	\$	\$	\$	\$
	26. PROPERTY	I. CONSUMABLES	J. LIVESTOCK	K. DRUGS	L. MARINE ITEMS	M. CONSTRUCTION ITEMS	N. LAWN AND GARDEN	O. SPORTING GOODS	P. MISC BICYCLE
	STOLEN	\$	\$	\$	\$	\$	\$	\$	\$
	RECOVERED	\$	\$	\$	\$	\$	\$	\$	\$

27. PROPERTY RECOVERED: LOCALLY _____ OTHER JURISDICTION _____ (INSERT O OR L)

PROPERTY ITEMIZATION	PROPERTY STOLEN/RECOVERED ITEMIZATION, USE THE FOLLOWING FORMAT			31. SERIAL NUMBER	32. CODE	
	28. QUANTITY	29. ARTICLE NAME	30. BRAND NAME		S	R
					<input type="checkbox"/>	<input type="checkbox"/>
					<input type="checkbox"/>	<input type="checkbox"/>
					<input type="checkbox"/>	<input type="checkbox"/>
					<input type="checkbox"/>	<input type="checkbox"/>
					<input type="checkbox"/>	<input type="checkbox"/>
					<input type="checkbox"/>	<input type="checkbox"/>

33. PROPERTY DAMAGE AMOUNT \$ _____ 34. INSURANCE COMPANY _____

35. OFFICER ASSAULTED Y N 36. ARSON Y N 37. STRUCTURE CODE _____ 38. DAMAGE \$ _____

47. CIB ENTERED CANCELLED
 NCIC
 OTHER BROADCAST

48. TOTAL AMOUNT PROPERTY STOLEN \$ _____

49. TOTAL AMOUNT PROPERTY RECOVERED \$ _____

50. IS REPORT CONTINUED? YES NO

51. CAUTION INDICATORS, ATLS ETC.

52. DATA PROCESS INFORMATION:

COMPUTER ENTERED DATE 13.8.99
 MICROFILM INDEXED INITIAL AS
 IS CASE CLASSIFICATION CORRECT? Y N
 IF N HAS CORRECTION BEEN MADE? N

53. FILE APPROVAL

BY AS DATE 03.08.99

S99 INC 00014 1631011 152000

4. INCIDENT
CS/699-00242

5. INCIDENT LOCATION
CR

6. NAME - LAST - FIRST - MI
Anonymous

7. D.O.B.

8. ADDRESS

9. TX-HOME

11. CITY STATE ZIP

10. TX-BUSINESS

12. DETAILS
See attached informational sheet.

INCIDENT CARD

18. ASSIGNED
ALL
MISO
O'Hearn
4010
929
H516

19. REC. BY
922

20. DIS. BY
922

22. TYPE OF REPORT
1. INCIDENT
2. ACCIDENT
3. CITATION
4. NONE

21. HOW REC'D.
1. 911
2. POLICE RADIO
3. PHONE CS
4. TTY
5. IN PERSON
6. ON VIEW
7. OFF. OFF DUTY
8. C.B. RADIO
9. OTHER

23. STATUS
1. UNFOUNDED
2. PNL
3. OTHER
4. CLEARED
5. EXCEPT CLEARED

24. DATE CLEARED
10/25/99

25. OFFENSE TYPE
1. ADULT NA
2. JUVENILE
3. UNKNOWN

13. DAY
SUN 1 THU 5
MON 2 **FRI 6**
TUE 3 SAT 7
WED 4

39. (CODE S-SUSPECT W-WITNESS V-VICTIM O-OTHER)							
CODE	40. NAME-LAST	FIRST	MI	41. D.O.B.	42. ADDRESS	43. TELEPHONE	
O	GRUPE	121445	MARY	JO	CTH F, Newton		
O	REICHWALDT	150273	PHILIP		CTH C, Manitowoc		
O	CHIZEK TRUCKING	22151			CTH F, Newton		

01/22/99 @ 1015 Hrs.: I, Lt. O'Hearn, arrived at CHIZEK TRUCKING where I met with MARY JO GRUPE who is an employee there. I informed her we received a Crime Stoppers report that inside the CHIZEK TRANSPORT, a Blazer-type vehicle (silver and black in color) is being worked on and grill damage is being repaired. I advised GRUPE about the incident with the hit and run. She stated she was aware of that and would allow me to view the area of CHIZEK TRUCKING.

I was escorted by GRUPE to all of the enclosed areas within the facility of CHIZEK TRUCKING. I saw no vehicles matching the description of the hit and run vehicle being worked on or any type of parts around that would lead to any type of suspicion that any activity concerning the hit and run would be there.

There is an individual who works at CHIZEK TRUCKING, PHILIP REICHWALDT, who owns a 1984 Chevy pickup truck, 6000-pound model. I saw this vehicle and checked further into it. I found this vehicle bearing RP BJ95556 has been inspected by Lt. M. Bushman and also can be cleared.

At this point, this Crime Stopper report can be closed as the area has been checked, and no vehicle bearing this make/model/resemblance to our vehicle is being worked on in the area viewed by me. TKOHearn /bjc

45. IF COMPLAINANT DIFFERENT THEN CALLER, ENTER NAME, ADDRESS, D.O.B., TELEPHONE.

46. IF CODE O (OTHER) IS USED IN FIELD #39, EXPLAIN.

INCIDENT REPORT: NOTE: IF SECTION 22 ABOVE HAS NUMBER 4 CHECKED, DO NOT GO BEYOND THIS LINE WITHOUT RECORDS SECTION BEING ADVISED, OR NO RECORD ENTRIES WILL BE MADE BELOW THIS LINE.

PROPERTY VALUE	26. PROPERTY	A. CURRENCY	B. JEWELRY	C. FURS CLOTHING	D. VEHICLE (LOCAL)	E. OFFICE EQUIPMENT	F. RADIO, TV CAMERAS	G. FIREARMS	H. HOUSE-HOLD GOODS
	STOLEN	\$	\$	\$	\$	\$	\$	\$	\$
	RECOVERED	\$	\$	\$	\$	\$	\$	\$	\$
	26. PROPERTY	I. CONSUMABLES	J. LIVESTOCK	K. DRUGS	L. MARINE ITEMS	M. CONSTRUCTION ITEMS	N. LAWN AND GARDEN	O. SPORTING GOODS	P. MISC BICYCLE
STOLEN	\$	\$	\$	\$	\$	\$	\$	\$	
RECOVERED	\$	\$	\$	\$	\$	\$	\$	\$	

27. PROPERTY RECOVERED: LOCALLY OTHER JURISDICTION (INSERT O OR L)

PROPERTY ITEMIZATION	PROPERTY STOLEN/RECOVERED ITEMIZATION, USE THE FOLLOWING FORMAT				
	28. QUANTITY	29. ARTICLE NAME	30. BRAND NAME	31. SERIAL NUMBER	32. CODE
					S R <input type="checkbox"/> <input type="checkbox"/>
					S R <input type="checkbox"/> <input type="checkbox"/>
					S R <input type="checkbox"/> <input type="checkbox"/>
					S R <input type="checkbox"/> <input type="checkbox"/>

33. PROPERTY DAMAGE AMOUNT \$ _____

34. INSURANCE COMPANY _____

35. OFFICER ASSAULTED Y N

36. ARSON Y N

37. STRUCTURE CODE _____

38. DAMAGE \$ _____

47. CIB ENTERED CANCELLED
 NCIC
 OTHER BROADCAST

48. TOTAL AMOUNT PROPERTY STOLEN \$ _____

49. TOTAL AMOUNT PROPERTY RECOVERED \$ _____

50. IS REPORT CONTINUED? YES NO

51. CAUTION INDICATORS, ATLS ETC.

52. DATA PROCESS INFORMATION:

COMPUTER ENTERED DATE 10/29/99
 MICROFILM INDEXED INITIAL AS

53. FILE APPROVAL

IS CASE CLASSIFICATION CORRECT? Y N
 IF N HAS CORRECTION BEEN MADE?

BY AK DATE 10/25/99

S99 NY U0611 1031011 15210.00

INCIDENT CARD

4. INCIDENT *OS/S99-00242*

5. INCIDENT LOCATION *CR*

6. NAME - LAST-FIRST-MI *ANONYMAUS* 7. D.O.B.

8. ADDRESS 9. TX-HOME

11. CITY STATE ZIP 10. TX-BUSINESS

18. ASSIGNED *ALL* *4010*

12. DETAILS *See info sheet - attached*

*[Redacted] no longer has
Blazer - @ 1 wk gone.*

14. REC'D	15. DISP	16. 10-23	17. 10-24
SUN 1	THU 5		
MON 2	FRI 6		
TUE 3	SAT 7		
WED 4			

19. REC. BY *922* 20. DIS. BY *922*

21. HOW REC'D.
1. 911
2. POLICE RADIO
3. PHONE
4. TTY
5. IN PERSON
6. ON VIEW
7. OFF. OFF DUTY
8. C.B. RADIO
9. OTHER

22. TYPE OF REPORT
1. INCIDENT
2. ACCIDENT
3. CITATION
4. NONE

23. STATUS
1. UNFOUNDED
2. PNL
3. **OTHER**
4. CLEARED
5. EXCEPT CLEARED

24. DATE CLEARED *03 08 99*

25. OFFENSE TYPE
1. ADULT NA
2. JUVENILE
3. UNKNOWN

39. (CODE S-SUSPECT W-WITNESS V-VICTIM O-OTHER)	40. NAME-LAST	FIRST	MI	41. D.O.B.	42. ADDRESS	43. TELEPHONE
0	Nernig Gary W.			<i>17439</i>	<i>[Redacted] S 25th Street Manitowoc</i>	<i>[Redacted]</i>

01/23/99 Deputy E. Glaesser checked the address of *[Redacted]* S 25th for the vehicle and also found the residence to be dark. *AT 0700 HRS.*

01/23/99 @ 0825 hrs contact was made with Nernig, Gary W. ref this complaint and Nernig did state he owns an '85 GMC Jimmy and further said that the vehicle is stored near Kiel as it is undriveable. Nernig claimed he was involved in a PD 10-50 on 01-13-99 in Sheboygan Co and hit a culvert which wiped out the Drivers side of the truck leaving it undriveable. Contact was made with SBSO and they confirmed the 10-50 information as relayed by Nernig including the exact time. It should be noted this vehicle would not match our suspect description and can be eliminated. EJC *ATG*

45. IF COMPLAINANT DIFFERENT THEN CALLER, ENTER NAME, ADDRESS, D.O.B., TELEPHONE.

46. IF CODE O (OTHER) IS USED IN FIELD #39, EXPLAIN.

INCIDENT REPORT: NOTE: IF SECTION 22 ABOVE HAS NUMBER 4 CHECKED, DO NOT GO BEYOND THIS LINE WITHOUT RECORDS SECTION BEING ADVISED, OR NO RECORD ENTRIES WILL BE MADE BELOW THIS LINE.

PROPERTY VALUE	26. PROPERTY	A. CURRENCY	B. JEWELRY	C. FURS CLOTHING	D. VEHICLE (LOCAL)	E. OFFICE EQUIPMENT	F. RADIO, TV CAMERAS	G. FIREARMS	H. HOUSE-HOLD GOODS
	STOLEN	\$	\$	\$	\$	\$	\$	\$	\$
	RECOVERED	\$	\$	\$	\$	\$	\$	\$	\$
	26. PROPERTY	I. CONSUMABLES	J. LIVESTOCK	K. DRUGS	L. MARINE ITEMS	M. CONSTRUCTION ITEMS	N. LAWN AND GARDEN	O. SPORTING GOODS	P. MISC BICYCLE
	STOLEN	\$	\$	\$	\$	\$	\$	\$	\$
	RECOVERED	\$	\$	\$	\$	\$	\$	\$	\$

27. PROPERTY RECOVERED: LOCALLY _____ OTHER JURISDICTION _____ (INSERT O OR L)

PROPERTY ITEMIZATION	PROPERTY STOLEN/RECOVERED ITEMIZATION, USE THE FOLLOWING FORMAT				
	28. QUANTITY	29. ARTICLE NAME	30. BRAND NAME	31. SERIAL NUMBER	32. CODE
					S R <input type="checkbox"/> <input type="checkbox"/>
					S R <input type="checkbox"/> <input type="checkbox"/>
					S R <input type="checkbox"/> <input type="checkbox"/>
					S R <input type="checkbox"/> <input type="checkbox"/>

33. PROPERTY DAMAGE AMOUNT \$ _____

34. INSURANCE COMPANY _____

35. OFFICER ASSAULTED Y N 36. ARSON Y N 37. STRUCTURE CODE _____ 38. DAMAGE \$ _____

47. CIB ENTERED CANCELLED
 NCIC
 OTHER BROADCAST

48. TOTAL AMOUNT PROPERTY STOLEN \$ _____

49. TOTAL AMOUNT PROPERTY RECOVERED \$ _____

50. IS REPORT CONTINUED? YES NO

51. CAUTION INDICATORS, ATLS ETC.

52. DATA PROCESS INFORMATION:

COMPUTER ENTERED DATE 3.8.99
 MICROFILM INDEXED INITIAL AS

IS CASE CLASSIFICATION CORRECT?
 IF N HAS CORRECTION BEEN MADE? Y N

53. FILE APPROVAL

BY R DATE 03/08/99

399 IV- 00070 10.20.11 1521000

INCIDENT CARD

4. INCIDENT **Crime Stopper / 599-00242**

5. INCIDENT LOCATION **S. 18th**

6. NAME-LAST-FIRST-MI **anonymous** 21 7. D.O.B.

8. ADDRESS 9. TX-HOME

11. CITY STATE ZIP 10. TX-BUSINESS

12. DETAILS **708**
 Reports William Torrison of **S 18th St.**
 has a Chev Blazer with grill damage, passenger
 headlight and spoiler damage. Truck had been
 in the garage but he is now driving it.

18. ASSIGNED **Crime stopper** **929**

19. REC. BY **928** 20. DIS. BY

21. HOW REC'D.
 1. 911
 2. POLICE RADIO
 3. PHONE
 4. TTY
 5. IN PERSON
 6. ON VIEW
 7. OFF. OFF DUTY
 8. C.B. RADIO
 9. OTHER

22. TYPE OF REPORT
 1. INCIDENT
 2. ACCIDENT
 3. CITATION
 4. NONE

23. STATUS
 1. UNFOUNDED
 2. PNL
 3. OTHER
 4. CLEARED
 5. EXCEPT CLEARED

24. DATE **103108199**

25. OFFENSE TYPE
 1. ADULT NA
 2. JUVENILE
 3. UNKNOWN

21A. M.O.

14. REC'D	15. DISP	16. 10-23	17. 10-24
13. DAY			
SUN 1	THU 5		
MON 2	FRI 6		
TUE 3	SAT 7		
WED 4			

39. (CODE S-SUSPECT W-WITNESS V-VICTIM O-OTHER)

CODE	40. NAME-LAST	FIRST	MI	41. D.O.B.	42. ADDRESS	43. TELEPHONE

012299
 Checked by 414 and does not match./929

45. IF COMPLAINANT DIFFERENT THEN CALLER, ENTER NAME, ADDRESS, D.O.B., TELEPHONE.

46. IF CODE O (OTHER) IS USED IN FIELD #39, EXPLAIN.

INCIDENT REPORT: NOTE: IF SECTION 22 ABOVE HAS NUMBER 4 CHECKED, DO NOT GO BEYOND THIS LINE WITHOUT RECORDS SECTION BEING ADVISED, OR NO RECORD ENTRIES WILL BE MADE BELOW THIS LINE.

PROPERTY VALUE	26. PROPERTY	A. CURRENCY	B. JEWELRY	C. FURS CLOTHING	D. VEHICLE (LOCAL)	E. OFFICE EQUIPMENT	F. RADIO, TV CAMERAS	G. FIREARMS	H. HOUSE-HOLD GOODS
	STOLEN	\$	\$	\$	\$	\$	\$	\$	\$
	RECOVERED	\$	\$	\$	\$	\$	\$	\$	\$
	26. PROPERTY	I. CONSUM-ABLES	J. LIVESTOCK	K. DRUGS	L. MARINE ITEMS	M. CONSTRUCTION ITEMS	N. LAWN AND GARDEN	O. SPORTING GOODS	P. MISC BICYCLE
STOLEN	\$	\$	\$	\$	\$	\$	\$	\$	
RECOVERED	\$	\$	\$	\$	\$	\$	\$	\$	

27. PROPERTY RECOVERED: LOCALLY _____ OTHER JURISDICTION _____ (INSERT O OR L)

PROPERTY ITEMIZATION	PROPERTY STOLEN/RECOVERED ITEMIZATION, USE THE FOLLOWING FORMAT				
	28. QUANTITY	29. ARTICLE NAME	30. BRAND NAME	31. SERIAL NUMBER	32. CODE
					S R <input type="checkbox"/> <input type="checkbox"/>
					S R <input type="checkbox"/> <input type="checkbox"/>
					S R <input type="checkbox"/> <input type="checkbox"/>
					S R <input type="checkbox"/> <input type="checkbox"/>
					S R <input type="checkbox"/> <input type="checkbox"/>

33. PROPERTY DAMAGE AMOUNT \$ _____ 34. INSURANCE COMPANY _____

35. OFFICER ASSAULTED Y N 36. ARSON Y N 37. STRUCTURE CODE _____ 38. DAMAGE \$ _____

47. CIB NCIC OTHER BROADCAST	ENTERED	CANCELLED	48. TOTAL AMOUNT PROPERTY STOLEN \$ _____
	<input type="checkbox"/>	<input type="checkbox"/>	
	<input type="checkbox"/>	<input type="checkbox"/>	
			49. TOTAL AMOUNT PROPERTY RECOVERED \$ _____

50. IS REPORT CONTINUED? YES NO 51. CAUTION INDICATORS, ATLS ETC.

52. DATA PROCESS INFORMATION:

COMPUTER ENTERED DATE 13.5.99

MICROFILM INDEXED INITIAL KS

IS CASE CLASSIFICATION CORRECT? Y N
IF N HAS CORRECTION BEEN MADE? Y N

53. FILE APPROVAL
BY R DATE 13.08.99

399 11- 00073 10-21-11 15X1000

INCIDENT CARD

4. INCIDENT
 CrimeStopper / 599-00242

5. INCIDENT LOCATION
 Rock Street

6. NAME - LAST - FIRST - MI
 anonymous 2

7. D.O.B.

8. ADDRESS

9. TX-HOME

11. CITY STATE ZIP

10. TX-BUSINESS

12. DETAILS
 Rpts truck owned by Gilbert Moreno 8258
 windshield and front end damage. Vehicle
 is grey with a red stripe.

18. ASSIGNED
 CrimeStopper 929

19. REC. BY
 928

20. DIS. BY
 -

22. TYPE OF REPORT
 1. INCIDENT
 2. ACCIDENT
 3. CITATION
 4. NONE

21. HOW REC'D.
 1. 911
 2. POLICE RADIO
 3. PHONE
 4. TTY
 5. IN PERSON
 6. ON VIEW
 7. OFF. OFF DUTY
 8. C.B. RADIO
 9. OTHER

23. STATUS
 1. UNFOUNDED
 2. PNL
 3. OTHER
 4. CLEARED
 5. EXCEPT CLEARED

24. DATE
 CLEARED 10/28/11

25. OFFENSE TYPE
 1. ADULT
 2. JUVENILE
 3. UNKNOWN

21A. M.O.

14. REC'D	15. DISP	16. 10-23	17. 10-24
13. DAY			
SUN 1	THU 5		
MON 2	FRI 6		
TUE 3	SAT 7		
WED 4			

39. (CODE S-SUSPECT W-WITNESS V-VICTIM O-OTHER)

CODE	40. NAME - LAST	FIRST	MI	41. D.O.B.	42. ADDRESS	43. TELEPHONE

012299 2106 hrs: MTPD officer checked residence. Did not find any vehicle at residence. Was unable to make contact with any one at the residence. Neighbor stated they had owned a suburban black and orange in color. Also the ex-husband has been coming around with a truck with a plow. 935/lms

Vehicle checked out 1988 GMC no front end damage not the vehicle we are looking for. TJJ

45. IF COMPLAINANT DIFFERENT THEN CALLER, ENTER NAME, ADDRESS, D.O.B., TELEPHONE.

46. IF CODE O (OTHER) IS USED IN FIELD #39, EXPLAIN.

INCIDENT REPORT: NOTE: IF SECTION 22 ABOVE HAS NUMBER 4 CHECKED, DO NOT GO BEYOND THIS LINE WITHOUT RECORDS SECTION BEING ADVISED, OR NO RECORD ENTRIES WILL BE MADE BELOW THIS LINE.

PROPERTY VALUE	26. PROPERTY	A. CURRENCY	B. JEWELRY	C. FURS CLOTHING	D. VEHICLE (LOCAL)	E. OFFICE EQUIPMENT	F. RADIO, TV CAMERAS	G. FIREARMS	H. HOUSEHOLD GOODS
	STOLEN	\$	\$	\$	\$	\$	\$	\$	\$
	RECOVERED	\$	\$	\$	\$	\$	\$	\$	\$
	26. PROPERTY	I. CONSUMABLES	J. LIVESTOCK	K. DRUGS	L. MARINE ITEMS	M. CONSTRUCTION ITEMS	N. LAWN AND GARDEN	O. SPORTING GOODS	P. MISC BICYCLE
	STOLEN	\$	\$	\$	\$	\$	\$	\$	\$
	RECOVERED	\$	\$	\$	\$	\$	\$	\$	\$

27. PROPERTY RECOVERED: LOCALLY _____ OTHER JURISDICTION _____ (INSERT O OR L)

PROPERTY ITEMIZATION	PROPERTY STOLEN/RECOVERED ITEMIZATION, USE THE FOLLOWING FORMAT				
	28. QUANTITY	29. ARTICLE NAME	30. BRAND NAME	31. SERIAL NUMBER	32. CODE
					S <input type="checkbox"/> R <input type="checkbox"/>
					S <input type="checkbox"/> R <input type="checkbox"/>
					S <input type="checkbox"/> R <input type="checkbox"/>
					S <input type="checkbox"/> R <input type="checkbox"/>
					S <input type="checkbox"/> R <input type="checkbox"/>
					S <input type="checkbox"/> R <input type="checkbox"/>

33. PROPERTY DAMAGE AMOUNT \$ _____ 34. INSURANCE COMPANY _____

35. OFFICER ASSAULTED Y N 36. ARSON Y N 37. STRUCTURE CODE _____ 38. DAMAGE \$ _____

47. CIB ENTERED CANCELLED

NCIC

OTHER BROADCAST

48. TOTAL AMOUNT PROPERTY STOLEN \$ _____

49. TOTAL AMOUNT PROPERTY RECOVERED \$ _____

50. IS REPORT CONTINUED? YES NO 51. CAUTION INDICATORS, ATLS ETC.

52. DATA PROCESS INFORMATION:

COMPUTER ENTERED DATE 3/8/99

MICROFILM INDEXED INITIAL KS

IS CASE CLASSIFICATION CORRECT? Y N

IF N HAS CORRECTION BEEN MADE? N

53. FILE APPROVAL

BY KS DATE 03/08/99

S99 IN: 00002 16301 02000

INCIDENT CARD

4. INCIDENT CS-599-00242

18. ASSIGNED MTSO 929

5. INCIDENT LOCATION 8th st. off of Michigan

6. NAME- LAST-FIRST MI [REDACTED] 7. D.O.B. [REDACTED]

9. TX-HOME [REDACTED]

10. TX-BUSINESS [REDACTED]

12. DETAILS Parts missing from grill. Parked on 8th off of Michigan # AH13446

14. REC'D 15. DISP 16. 10-23 17. 10-24

13. DAY SUN 1 THU 5 MON 2 FRI 6 TUE 3 SAT 7 WED 4

19. REC. BY 20. DIS. BY 22. TYPE OF REPORT 1. INCIDENT 2. ACCIDENT 3. CITATION 4. NONE

21. HOW REC'D. 1. 911 2. POLICE RADIO 3. PHONE 4. TTY 5. IN PERSON 6. ON VIEW 7. OFF. OFF DUTY 8. C.B. RADIO 9. OTHER

23. STATUS 1. UNFOUNDED 2. PNL 3. OTHER 4. CLEARED 5. EXCEPT CLEARED 24. DATE CLEARED 03/08/99 25. OFFENSE TYPE 1. ADULT 2. JUVENILE 3. UNKNOWN

Table with 5 columns: CODE, 40. NAME-LAST, FIRST, MI, 41. D.O.B., 42. ADDRESS, 43. TELEPHONE. Row 1: 39. (CODE S-SUSPECT W-WITNESS V-VICTIM O-OTHER)

01/23/99 checked the area of 8th and Michigan and was unable to locate the vehicle . I Deputy E Glaeser also checked the residence at [REDACTED] Sunrise Lane and found no one home and no vehicle in the garage. @1050Hrs 410 Raube checked the residence again and found no one home and no vehicle. Will have to be rechecked. E JG [Signature]

01/24/99 @ 1110 Hrs Deputy Glaeser checked the vehicle as it was parked at Jageman Plating in MIWC. Vehicle does have right front damage but the grill color does not match our suspect. Nothing further. E JG [Signature]

45. IF COMPLAINANT DIFFERENT THEN CALLER, ENTER NAME, ADDRESS, D.O.B., TELEPHONE.

46. IF CODE O (OTHER) IS USED IN FIELD #39, EXPLAIN.

INCIDENT REPORT: NOTE: IF SECTION 22 ABOVE HAS NUMBER 4 CHECKED, DO NOT GO BEYOND THIS LINE WITHOUT RECORDS SECTION BEING ADVISED, OR NO RECORD ENTRIES WILL BE MADE BELOW THIS LINE.

PROPERTY VALUE	26. PROPERTY	A. CURRENCY	B. JEWELRY	C. FURS CLOTHING	D. VEHICLE (LOCAL)	E. OFFICE EQUIPMENT	F. RADIO, TV CAMERAS	G. FIREARMS	H. HOUSE-HOLD GOODS
	STOLEN	\$	\$	\$	\$	\$	\$	\$	\$
	RECOVERED	\$	\$	\$	\$	\$	\$	\$	\$
	26. PROPERTY	I. CONSUMABLES	J. LIVESTOCK	K. DRUGS	L. MARINE ITEMS	M. CONSTRUCTION ITEMS	N. LAWN AND GARDEN	O. SPORTING GOODS	P. MISC BICYCLE
STOLEN	\$	\$	\$	\$	\$	\$	\$	\$	
RECOVERED	\$	\$	\$	\$	\$	\$	\$	\$	

27. PROPERTY RECOVERED: LOCALLY _____ OTHER JURISDICTION _____ (INSERT O OR L)

PROPERTY ITEMIZATION	PROPERTY STOLEN/RECOVERED ITEMIZATION, USE THE FOLLOWING FORMAT				
	28. QUANTITY	29. ARTICLE NAME	30. BRAND NAME	31. SERIAL NUMBER	32. CODE
					S R <input type="checkbox"/> <input type="checkbox"/>
					S R <input type="checkbox"/> <input type="checkbox"/>
					S R <input type="checkbox"/> <input type="checkbox"/>
					S R <input type="checkbox"/> <input type="checkbox"/>
					S R <input type="checkbox"/> <input type="checkbox"/>

33. PROPERTY DAMAGE AMOUNT \$ _____ 34. INSURANCE COMPANY _____

35. OFFICER ASSAULTED Y N 36. ARSON Y N 37. STRUCTURE CODE _____ 38. DAMAGE \$ _____

47. CIB NCIC OTHER BROADCAST	ENTERED	CANCELLED	48. TOTAL AMOUNT PROPERTY STOLEN \$ _____
	<input type="checkbox"/>	<input type="checkbox"/>	
	<input type="checkbox"/>	<input type="checkbox"/>	
			49. TOTAL AMOUNT PROPERTY RECOVERED \$ _____

50. IS REPORT CONTINUED? YES NO 51. CAUTION INDICATORS, ATLS ETC.

52. DATA PROCESS INFORMATION:
 COMPUTER ENTERED DATE 3/8/99
 MICROFILM INDEXED INITIAL KS
 IS CASE CLASSIFICATION CORRECT? Y N
 IF N HAS CORRECTION BEEN MADE? Y N

53. FILE APPROVAL
 BY RP DATE 03/09/99

S99 IN 00090 163011 10000

INCIDENT CARD

4. INCIDENT 935 / S99-00242

5. INCIDENT LOCATION Oshkosh

6. NAME - LAST - FIRST - MI Anonymous (2) 7. D.O.B.

8. ADDRESS 9. TX-HOME

11. CITY STATE ZIP 10. TX-BUSINESS

12. DETAILS See Attached.

14. REC'D	15. DISP	16. 10-23	17. 10-24
13. DAY			
SUN 1	THU 5		
MON 2	FRI 6		
TUE 3	SAT 7		
WED 4			

18. ASSIGNED MTSO 929

19. REC. BY 935 20. DIS. BY

21. HOW REC'D.
 1. 911
 2. POLICE RADIO
 3. PHONE
 4. TTY
 5. IN PERSON
 6. ON VIEW
 7. OFF. OFF DUTY
 8. C.B. RADIO
 9. OTHER

22. TYPE OF REPORT
 1. INCIDENT
 2. ACCIDENT
 3. CITATION
 4. NONE

23. STATUS
 1. UNFOUNDED
 2. PNL
 3. OTHER
 4. CLEARED
 5. EXCEPT CLEARED

24. DATE CLEARED 03/16/99

25. OFFENSE TYPE
 1. ADULT NA
 2. JUVENILE
 3. UNKNOWN

21A. M.O.

39. (CODE S-SUSPECT W-WITNESS V-VICTIM O-OTHER)							
CODE	40. NAME-LAST	FIRST	MI	41. D.O.B.	42. ADDRESS	43. TELEPHONE	

unable to do any follow up.tty sent to Oshkosh PD
 No registration obtained, unable to locate by Oshkosh PD. M.J.Bushman



45. IF COMPLAINANT DIFFERENT THEN CALLER, ENTER NAME, ADDRESS, D.O.B., TELEPHONE.

46. IF CODE O (OTHER) IS USED IN FIELD #39, EXPLAIN.

INCIDENT REPORT: NOTE: IF SECTION 22 ABOVE HAS NUMBER 4 CHECKED, DO NOT GO BEYOND THIS LINE WITHOUT RECORDS SECTION BEING ADVISED, OR NO RECORD ENTRIES WILL BE MADE BELOW THIS LINE.

PROPERTY VALUE	26. PROPERTY	A. CURRENCY	B. JEWELRY	C. FURS CLOTHING	D. VEHICLE (LOCAL)	E. OFFICE EQUIPMENT	F. RADIO, TV CAMERAS	G. FIREARMS	H. HOUSE-HOLD GOODS
	STOLEN	\$	\$	\$	\$	\$	\$	\$	\$
	RECOVERED	\$	\$	\$	\$	\$	\$	\$	\$
	26. PROPERTY	I. CONSUMABLES	J. LIVESTOCK	K. DRUGS	L. MARINE ITEMS	M. CONSTRUCTION ITEMS	N. LAWN AND GARDEN	O. SPORTING GOODS	P. MISC BICYCLE
	STOLEN	\$	\$	\$	\$	\$	\$	\$	\$
	RECOVERED	\$	\$	\$	\$	\$	\$	\$	\$

27. PROPERTY RECOVERED: LOCALLY _____ OTHER JURISDICTION _____ (INSERT O OR L)

PROPERTY ITEMIZATION	PROPERTY STOLEN/RECOVERED ITEMIZATION, USE THE FOLLOWING FORMAT				
	28. QUANTITY	29. ARTICLE NAME	30. BRAND NAME	31. SERIAL NUMBER	32. CODE
					S R <input type="checkbox"/> <input type="checkbox"/>
					S R <input type="checkbox"/> <input type="checkbox"/>
					S R <input type="checkbox"/> <input type="checkbox"/>
					S R <input type="checkbox"/> <input type="checkbox"/>

33. PROPERTY DAMAGE AMOUNT \$ _____

34. INSURANCE COMPANY _____

35. OFFICER ASSAULTED Y N

36. ARSON Y N

37. STRUCTURE CODE _____ 38. DAMAGE \$ _____

47. CIB ENTERED CANCELLED
 NCIC
 OTHER BROADCAST

48. TOTAL AMOUNT PROPERTY STOLEN \$ _____

49. TOTAL AMOUNT PROPERTY RECOVERED \$ _____

50. IS REPORT CONTINUED? YES NO

51. CAUTION INDICATORS, ATLS ETC.

52. DATA PROCESS INFORMATION:

COMPUTER ENTERED DATE 3/8/99
 MICROFILM INDEXED INITIAL JS

53. FILE APPROVAL

IS CASE CLASSIFICATION CORRECT? N
 IF N HAS CORRECTION BEEN MADE? N

BY [Signature] DATE 3/6/99

S99 N^o 00003 16301 92000

INCIDENT CARD

4. INCIDENT **CS/S99-00242**

5. INCIDENT LOCATION **- 1200 block Wash. St, Mtwa**

6. NAME - LAST - FIRST - MI **Crow.** 7. D.O.B.

8. ADDRESS 9. TX-HOME

11. CITY STATE ZIP 10. TX-BUSINESS

12. DETAILS **Black Chev. Chyenne, HKV173 observed 1/20/99 parked on north side of Wash St., Manitowoc in 1200 block.**

18. ASSIGNED **MTSO 929**

19. REC. BY **920** 20. DIS. BY

21. HOW REC'D.
 1. 911
 2. POLICE RADIO
 3. PHONE
 4. TTY
 5. IN PERSON
 6. ON VIEW
 7. OFF. OFF DUTY
 8. C.B. RADIO
 9. OTHER

22. TYPE OF REPORT
 1. INCIDENT
 2. ACCIDENT
 3. CITATION
 4. NONE

23. STATUS
 1. UNFOUNDED
 2. PNL
 3. OTHER
 4. CLEARED
 5. EXCEPT CLEARED

24. DATE CLEARED **103/08/99**

25. OFFENSE TYPE
 1. ADULT NA
 2. JUVENILE
 3. UNKNOWN

14. REC'D.	15. DISP.	16. 10-23	17. 10-24
13. DAY			
SUN 1	THU 5		
MON 2	FR 6		
TUE 3	SAT 7		
WED 4			

39. (CODE S-SUSPECT W-WITNESS V-VICTIM O-OTHER)					42. ADDRESS	43. TELEPHONE
CODE	40. NAME-LAST	FIRST	MI	41. D.O.B.		

01/23/99 01-22-99 Vehicle had a black plastic cover on the grill. Not sure of damage. sbraun920
 @ 0645 Hrs 417 checked the vehicle and it does not match as it does have a chrome grill and no damage.
 EJG

45. IF COMPLAINANT DIFFERENT THEN CALLER, ENTER NAME, ADDRESS, D.O.B., TELEPHONE.

46. IF CODE O (OTHER) IS USED IN FIELD #39, EXPLAIN.

INCIDENT REPORT: NOTE: IF SECTION 22 ABOVE HAS NUMBER 4 CHECKED, DO NOT GO BEYOND THIS LINE WITHOUT RECORDS SECTION BEING ADVISED, OR NO RECORD ENTRIES WILL BE MADE BELOW THIS LINE.

PROPERTY VALUE	26. PROPERTY	A. CURRENCY	B. JEWELRY	C. FURS CLOTHING	D. VEHICLE (LOCAL)	E. OFFICE EQUIPMENT	F. RADIO, TV, CAMERAS	G. FIREARMS	H. HOUSE-HOLD GOODS
	STOLEN	\$	\$	\$	\$	\$	\$	\$	\$
	RECOVERED	\$	\$	\$	\$	\$	\$	\$	\$
	26. PROPERTY	I. CONSUMABLES	J. LIVESTOCK	K. DRUGS	L. MARINE ITEMS	M. CONSTRUCTION ITEMS	N. LAWN AND GARDEN	O. SPORTING GOODS	P. MISC BICYCLE
STOLEN	\$	\$	\$	\$	\$	\$	\$	\$	
RECOVERED	\$	\$	\$	\$	\$	\$	\$	\$	

27. PROPERTY RECOVERED: LOCALLY _____ OTHER JURISDICTION _____ (INSERT O OR L)

PROPERTY ITEMIZATION	PROPERTY STOLEN/RECOVERED ITEMIZATION, USE THE FOLLOWING FORMAT				
	28. QUANTITY	29. ARTICLE NAME	30. BRAND NAME	31. SERIAL NUMBER	32. CODE
					S R <input type="checkbox"/> <input type="checkbox"/>
					S R <input type="checkbox"/> <input type="checkbox"/>
					S R <input type="checkbox"/> <input type="checkbox"/>
					S R <input type="checkbox"/> <input type="checkbox"/>
					S R <input type="checkbox"/> <input type="checkbox"/>

33. PROPERTY DAMAGE AMOUNT \$ _____ 34. INSURANCE COMPANY _____

35. OFFICER ASSAULTED Y N 36. ARSON Y N 37. STRUCTURE CODE _____ 38. DAMAGE \$ _____

47. CIB ENTERED CANCELLED
 NCIC
 OTHER BROADCAST

48. TOTAL AMOUNT PROPERTY STOLEN \$ _____

49. TOTAL AMOUNT PROPERTY RECOVERED \$ _____

50. IS REPORT CONTINUED? YES NO

51. CAUTION INDICATORS, ATLS ETC.

52. DATA PROCESS INFORMATION:

COMPUTER ENTERED DATE 3/8/99
 MICROFILM INDEXED INITIAL RS

53. FILE APPROVAL

IS CASE CLASSIFICATION CORRECT? Y N
 IF N HAS CORRECTION BEEN MADE? Y N

BY R DATE 03/08/99

599 IN 00001 103011 122440

INCIDENT CARD

4. INCIDENT
ES / 599-00212

5. INCIDENT LOCATION
Two Rivers

6. NAME - LAST - FIRST - MI
Anonymous

7. D.O.B.

8. ADDRESS

9. TX-HOME

10. TX-BUSINESS

11. CITY STATE ZIP

12. DETAILS
See Attached.

5891
66/ce/1a
01/22/98

18. ASSIGNED
MISO 929

19. REC. BY
935

20. DIS. BY

21. HOW REC'D.
1. 911
2. POLICE RADIO
3. PHONE
4. TTY
5. IN PERSON
6. ON VIEW
7. OFF. OFF DUTY
8. C.B. RADIO
9. OTHER

22. TYPE OF REPORT
1. INCIDENT
2. ACCIDENT
3. CITATION
4. NONE

23. STATUS
1. UNFOUNDED
2. PNL
3. OTHER
4. CLEARED
5. EXCEPT CLEARED

24. DATE CLEARED
10310899

25. OFFENSE TYPE
1. ADULT NA
2. JUVENILE
3. UNKNOWN

14. REC'D

15. DISP

16. 10-23

17. 10-24

13. DAY
SUN 1 THU 5
MON 2 FRI 6
TUE 3 SAT 7
WED 4

39. (CODE S-SUSPECT W-WITNESS V-VICTIM O-OTHER)

CODE	40. NAME - LAST	FIRST	MI	41. D.O.B.	42. ADDRESS	43. TELEPHONE

01/22/98 The crimestoppers information was passed on to Two Rivers police and 847 made an attempt to locate. This would be a local vehicle and was not seen before the end of his shift. Information passed on and completed by 3rd shift, they advise this is not the suspect vehicle. M.J. Bushman

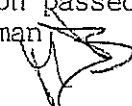

45. IF COMPLAINANT DIFFERENT THEN CALLER, ENTER NAME, ADDRESS, D.O.B., TELEPHONE.

46. IF CODE O (OTHER) IS USED IN FIELD #39, EXPLAIN.

INCIDENT REPORT: NOTE: IF SECTION 22 ABOVE HAS NUMBER 4 CHECKED, DO NOT GO BEYOND THIS LINE WITHOUT RECORDS SECTION BEING ADVISED, OR NO RECORD ENTRIES WILL BE MADE BELOW THIS LINE.

PROPERTY VALUE	26. PROPERTY	A. CURRENCY	B. JEWELRY	C. FURS CLOTHING	D. VEHICLE (LOCAL)	E. OFFICE EQUIPMENT	F. RADIO, TV CAMERAS	G. FIREARMS	H. HOUSE-HOLD GOODS
	STOLEN	\$	\$	\$	\$	\$	\$	\$	\$
	RECOVERED	\$	\$	\$	\$	\$	\$	\$	\$
	26. PROPERTY	I. CONSUM-ABLES	J. LIVESTOCK	K. DRUGS	L. MARINE ITEMS	M. CONSTRUCTION ITEMS	N. LAWN AND GARDEN	O. SPORTING GOODS	P. MISC BICYCLE
STOLEN	\$	\$	\$	\$	\$	\$	\$	\$	
RECOVERED	\$	\$	\$	\$	\$	\$	\$	\$	

27. PROPERTY RECOVERED: LOCALLY ____ OTHER JURISDICTION ____ (INSERT O OR L)

PROPERTY ITEMIZATION	PROPERTY STOLEN/RECOVERED ITEMIZATION, USE THE FOLLOWING FORMAT				
	28. QUANTITY	29. ARTICLE NAME	30. BRAND NAME	31. SERIAL NUMBER	32. CODE
					S R <input type="checkbox"/> <input type="checkbox"/>
					S R <input type="checkbox"/> <input type="checkbox"/>
					S R <input type="checkbox"/> <input type="checkbox"/>
					S R <input type="checkbox"/> <input type="checkbox"/>
					S R <input type="checkbox"/> <input type="checkbox"/>

33. PROPERTY DAMAGE AMOUNT \$ _____ 34. INSURANCE COMPANY _____

35. OFFICER ASSAULTED Y N 36. ARSON Y N 37. STRUCTURE CODE _____ 38. DAMAGE \$ _____

47. CIB NCIC OTHER BROADCAST	ENTERED	CANCELLED	48. TOTAL AMOUNT PROPERTY STOLEN \$ _____
	<input type="checkbox"/>	<input type="checkbox"/>	
	<input type="checkbox"/>	<input type="checkbox"/>	
			49. TOTAL AMOUNT PROPERTY RECOVERED \$ _____

50. IS REPORT CONTINUED? YES NO 51. CAUTION INDICATORS, ATLS ETC.

52. DATA PROCESS INFORMATION:

COMPUTER ENTERED DATE 13.5.99

MICROFILM INDEXED INITIAL [Signature]

IS CASE CLASSIFICATION CORRECT? IF N HAS CORRECTION BEEN MADE? Y N

53. FILE APPROVAL
BY [Signature] DATE 03.08.99

Rev: TRPD 847 / Stroff-

That is a local veh - he has seen it around TR before. Unable to check today 1-22-99, will forward to 3rd Shift & continue checking TR for veh tomorrow.

Stopped in Hot ~~See #1 per~~
from Gray - 1635
GMC - 86 -
Grill damage -
Across St

(4)

Anonymous S.
[Redacted]
[Redacted]
[Redacted]

British Compa Slim
Windsor
Dave Keary
Retain

555 17- 00030 16710 11 1521000

INCIDENT CARD

4 INCIDENT MS / 599.00242

18. ASSIGNED MBO 929

5. INCIDENT LOCATION

6. NAME - LAST-FIRST-MI Anonymous 7. D.O.B.

8. ADDRESS 9. TX-HOME

11. CITY STATE ZIP 10. TX-BUSINESS

12. DETAILS See Attached.

14. REC'D	15. DISP	16. 10-23	17. 10-24
13. DAY			
SUN 1	THU 5		
MON 2	<u>FRI 6</u>		
TUE 3	SAT 7		
WED 4			

19. REC. BY 935 20. DIS. BY
22. TYPE OF REPORT
1. INCIDENT
2. ACCIDENT
3. CITATION
4. NONE

21. HOW REC'D.
1. 911
2. POLICE RADIO
3. PHONE
4. TTY
5. IN PERSON
6. ON VIEW
7. OFF. OFF DUTY
8. C.B. RADIO
9. OTHER
23. STATUS
1. UNFOUNDED
2. PNL
3. OTHER
4. CLEARED
5. EXCEPT CLEARED

24. DATE CLEARED 10308199
25. OFFENSE TYPE
1. ADULT NA
2. JUVENILE
3. UNKNOWN

39. (CODE S-SUSPECT W-WITNESS V-VICTIM O-OTHER)						
CODE	40. NAME-LAST	FIRST	MI	41. D.O.B.	42. ADDRESS	43. TELEPHONE

5900

RHAS check only vehicle registered to listed subject is an 87 ford. Vehicle does not fit what we are looking for

45. IF COMPLAINANT DIFFERENT THEN CALLER, ENTER NAME, ADDRESS, D.O.B., TELEPHONE.

46. IF CODE O (OTHER) IS USED IN FIELD #39, EXPLAIN.

INCIDENT REPORT: NOTE: IF SECTION 22 ABOVE HAS NUMBER 4 CHECKED, DO NOT GO BEYOND THIS LINE WITHOUT RECORDS SECTION BEING ADVISED, OR NO RECORD ENTRIES WILL BE MADE BELOW THIS LINE.

PROPERTY VALUE	26. PROPERTY	A. CURRENCY	B. JEWELRY	C. FURS CLOTHING	D. VEHICLE (LOCAL)	E. OFFICE EQUIPMENT	F. RADIO, TV CAMERAS	G. FIREARMS	H. HOUSE-HOLD GOODS
	STOLEN	\$	\$	\$	\$	\$	\$	\$	\$
	RECOVERED	\$	\$	\$	\$	\$	\$	\$	\$
	26. PROPERTY	I. CONSUMABLES	J. LIVESTOCK	K. DRUGS	L. MARINE ITEMS	M. CONSTRUCTION ITEMS	N. LAWN AND GARDEN	O. SPORTING GOODS	P. MISC BICYCLE
	STOLEN	\$	\$	\$	\$	\$	\$	\$	\$
	RECOVERED	\$	\$	\$	\$	\$	\$	\$	\$

27. PROPERTY RECOVERED: LOCALLY _____ OTHER JURISDICTION _____ (INSERT O OR L)

PROPERTY ITEMIZATION	PROPERTY STOLEN/RECOVERED ITEMIZATION, USE THE FOLLOWING FORMAT				
	28. QUANTITY	29. ARTICLE NAME	30. BRAND NAME	31. SERIAL NUMBER	32. CODE
					S R <input type="checkbox"/> <input type="checkbox"/>
					S R <input type="checkbox"/> <input type="checkbox"/>
					S R <input type="checkbox"/> <input type="checkbox"/>
					S R <input type="checkbox"/> <input type="checkbox"/>

33. PROPERTY DAMAGE AMOUNT \$ _____ 34. INSURANCE COMPANY _____

35. OFFICER ASSAULTED Y N 36. ARSON Y N 37. STRUCTURE CODE _____ 38. DAMAGE \$ _____

47. CIB	ENTERED <input type="checkbox"/>	CANCELLED <input type="checkbox"/>	48. TOTAL AMOUNT PROPERTY STOLEN \$ _____
NCIC	<input type="checkbox"/>	<input type="checkbox"/>	
OTHER BROADCAST	<input type="checkbox"/>	<input type="checkbox"/>	
			49. TOTAL AMOUNT PROPERTY RECOVERED \$ _____

50. IS REPORT CONTINUED? YES NO 51. CAUTION INDICATORS, ATLS ETC.

52. DATA PROCESS INFORMATION:

COMPUTER ENTERED DATE 3/8/99

MICROFILM INDEXED INITIAL KS

IS CASE CLASSIFICATION CORRECT? Y N

IF N HAS CORRECTION BEEN MADE? Y N

53. FILE APPROVAL

BY KR DATE 03/08/99

599 192 00099 10,210,1 122000

4. INCIDENT *AS / 599-00242*

5. INCIDENT LOCATION *S / 8th ST*

6. NAME - LAST - FIRST - MI *Anonymous* 7. D.O.B.

8. ADDRESS 9. TX-HOME

11. CITY STATE ZIP 10. TX-BUSINESS

12. DETAILS *See Attached*

14. REC'D 15. DISP 16. 10-23 17. 10-24

13. DAY
 SUN 1 THU 5
 MON 2 **FRI 6**
 TUE 3 SAT 7
 WED 4

INCIDENT CARD

18. ASSIGNED *MJSO* 929

19. REC. BY *935* 20. DIS. BY

21. HOW REC'D.
 1. 911
 2. POLICE RADIO
 3. PHONE
 4. TTY
 5. IN PERSON
 6. ON VIEW
 7. OFF. OFF DUTY
 8. C.B. RADIO
 9. OTHER

22. TYPE OF REPORT
 1. INCIDENT
 2. ACCIDENT
 3. CITATION
 4. NONE

23. STATUS
 1. UNFOUNDED
 2. PNL
 3. OTHER
 4. **CLEARED**
 5. EXCEPT CLEARED

24. DATE CLEARED *10310899*

25. OFFENSE TYPE
 1. ADULT NA
 2. JUVENILE
 3. UNKNOWN

21A. M.O.

39. (CODE S-SUSPECT W-WITNESS V-VICTIM O-OTHER)

CODE	40. NAME - LAST	FIRST	MI	41. D.O.B.	42. ADDRESS	43. TELEPHONE

012299

Checked by 414, does not match./929

2 NS COMPLAINT SAME AS 599 00678

45. IF COMPLAINANT DIFFERENT THEN CALLER, ENTER NAME, ADDRESS, D.O.B., TELEPHONE.

46. IF CODE O (OTHER) IS USED IN FIELD #39, EXPLAIN.

INCIDENT REPORT: NOTE: IF SECTION 22 ABOVE HAS NUMBER 4 CHECKED, DO NOT GO BEYOND THIS LINE WITHOUT RECORDS SECTION BEING ADVISED, OR NO RECORD ENTRIES WILL BE MADE BELOW THIS LINE.

PROPERTY VALUE	26. PROPERTY	A. CURRENCY	B. JEWELRY	C. FURS CLOTHING	D. VEHICLE (LOCAL)	E. OFFICE EQUIPMENT	F. RADIO, TV CAMERAS	G. FIREARMS	H. HOUSE-HOLD GOODS
	STOLEN	\$	\$	\$	\$	\$	\$	\$	\$
	RECOVERED	\$	\$	\$	\$	\$	\$	\$	\$
	26. PROPERTY	I. CONSUMABLES	J. LIVESTOCK	K. DRUGS	L. MARINE ITEMS	M. CONSTRUCTION ITEMS	N. LAWN AND GARDEN	O. SPORTING GOODS	P. MISC BICYCLE
STOLEN	\$	\$	\$	\$	\$	\$	\$	\$	
RECOVERED	\$	\$	\$	\$	\$	\$	\$	\$	

27. PROPERTY RECOVERED: LOCALLY _____ OTHER JURISDICTION _____ (INSERT O OR L)

PROPERTY ITEMIZATION	PROPERTY STOLEN/RECOVERED ITEMIZATION, USE THE FOLLOWING FORMAT				
	28. QUANTITY	29. ARTICLE NAME	30. BRAND NAME	31. SERIAL NUMBER	32. CODE
					S <input type="checkbox"/> R <input type="checkbox"/>
					S <input type="checkbox"/> R <input type="checkbox"/>
					S <input type="checkbox"/> R <input type="checkbox"/>
					S <input type="checkbox"/> R <input type="checkbox"/>
					S <input type="checkbox"/> R <input type="checkbox"/>

33. PROPERTY DAMAGE AMOUNT \$ _____ 34. INSURANCE COMPANY _____

35. OFFICER ASSAULTED Y N 36. ARSON Y N 37. STRUCTURE CODE _____ 38. DAMAGE \$ _____

47. CIB	ENTERED <input type="checkbox"/>	CANCELLED <input type="checkbox"/>	48. TOTAL AMOUNT PROPERTY STOLEN \$ _____
NCIC	<input type="checkbox"/>	<input type="checkbox"/>	
OTHER BROADCAST	<input type="checkbox"/>	<input type="checkbox"/>	
			49. TOTAL AMOUNT PROPERTY RECOVERED \$ _____

50. IS REPORT CONTINUED? YES NO 51. CAUTION INDICATORS, ATLS ETC.

52. DATA PROCESS INFORMATION:

COMPUTER ENTERED DATE 13.8.99

MICROFILM INDEXED INITIAL KS

IS CASE CLASSIFICATION CORRECT? Y N

IF N HAS CORRECTION BEEN MADE? Y N

53. FILE APPROVAL

BY R DATE 03/08/99

599 IN= 00701 16,310,11 11,410,10

4. INCIDENT CS / S99-00242

5. INCIDENT LOCATION [REDACTED] Clover Rd.

6. NAME - LAST - FIRST - MI ANONY. (2) 7. D.O.B.

8. ADDRESS 9. TX-HOME

11. CITY STATE ZIP 10. TX-BUSINESS

12. DETAILS
 Rpts. Kevin J. Ziarnik [REDACTED] (149726)
 owns a full-size crew blazer
 that has not been seen since time
 of accident. LP# TNM534

INCIDENT CARD

18. ASSIGNED MTSO 9/2/99

19. REC. BY 938 20. DIS. BY

21. HOW REC'D.
 1. 911
 2. POLICE RADIO
 3. PHONE
 4. TTY
 5. IN PERSON
 6. ON VIEW
 7. OFF. OFF DUTY
 8. C.B. RADIO
 9. OTHER

22. TYPE OF REPORT
 1. INCIDENT
 2. ACCIDENT
 3. CITATION
 4. NONE

23. STATUS
 1. UNFOUNDED
 2. PNL
 3. OTHER
 4. CLEARED
 5. EXCEPT CLEARED

24. DATE CLEARED 103108199

25. OFFENSE TYPE
 1. ADULT NA
 2. JUVENILE
 3. UNKNOWN

14. REC'D	15. DISP	16. 10-23	17. 10-24
13. DAY			
SUN 1	THU 5		
MON 2	FRI 6		
TUE 3	SAT 7		
WED 4			

39. (CODE S-SUSPECT W-WITNESS V-VICTIM O-OTHER)

CODE	40. NAME-LAST	FIRST	MI	41. D.O.B.	42. ADDRESS	43. TELEPHONE

01/23/99 @ 0600 Hrs Deputy Glaeser checked with LT Bushman on this vehicle and 441 did relay he has personally checked this vehicle twice and it can be removed from suspect list. EKG 417

45. IF COMPLAINANT DIFFERENT THEN CALLER, ENTER NAME, ADDRESS, D.O.B., TELEPHONE.

46. IF CODE O (OTHER) IS USED IN FIELD #39, EXPLAIN.

INCIDENT REPORT: NOTE: IF SECTION 22 ABOVE HAS NUMBER 4 CHECKED, DO NOT GO BEYOND THIS LINE WITHOUT RECORDS SECTION BEING ADVISED, OR NO RECORD ENTRIES WILL BE MADE BELOW THIS LINE.

PROPERTY VALUE	26. PROPERTY	A. CURRENCY	B. JEWELRY	C. FURS CLOTHING	D. VEHICLE (LOCAL)	E. OFFICE EQUIPMENT	F. RADIO, TV CAMERAS	G. FIREARMS	H. HOUSE-HOLD GOODS
	STOLEN	\$	\$	\$	\$	\$	\$	\$	\$
	RECOVERED	\$	\$	\$	\$	\$	\$	\$	\$
	26. PROPERTY	I. CONSUMABLES	J. LIVESTOCK	K. DRUGS	L. MARINE ITEMS	M. CONSTRUCTION ITEMS	N. LAWN AND GARDEN	O. SPORTING GOODS	P. MISC BICYCLE
	STOLEN	\$	\$	\$	\$	\$	\$	\$	\$
	RECOVERED	\$	\$	\$	\$	\$	\$	\$	\$

27. PROPERTY RECOVERED: LOCALLY _____ OTHER JURISDICTION _____ (INSERT O OR L)

PROPERTY ITEMIZATION	PROPERTY STOLEN/RECOVERED ITEMIZATION, USE THE FOLLOWING FORMAT				
	28. QUANTITY	29. ARTICLE NAME	30. BRAND NAME	31. SERIAL NUMBER	32. CODE
					S R <input type="checkbox"/> <input type="checkbox"/>
					S R <input type="checkbox"/> <input type="checkbox"/>
					S R <input type="checkbox"/> <input type="checkbox"/>
					S R <input type="checkbox"/> <input type="checkbox"/>
					S R <input type="checkbox"/> <input type="checkbox"/>

33. PROPERTY DAMAGE AMOUNT \$ _____ 34. INSURANCE COMPANY _____

35. OFFICER ASSAULTED Y N 36. ARSON Y N 37. STRUCTURE CODE _____ 38. DAMAGE \$ _____

47. CIB ENTERED CANCELLED
 NCIC
 OTHER BROADCAST

48. TOTAL AMOUNT PROPERTY STOLEN \$ _____

49. TOTAL AMOUNT PROPERTY RECOVERED \$ _____

50. IS REPORT CONTINUED? YES NO

51. CAUTION INDICATORS, ATLS ETC.

52. DATA PROCESS INFORMATION:

COMPUTER ENTERED DATE 3/8/99
 MICROFILM INDEXED INITIAL AS

53. FILE APPROVAL

IS CASE CLASSIFICATION CORRECT? Y N
 IF N HAS CORRECTION BEEN MADE? Y N

BY RP DATE 03/08/99

S99 INE 00102 60310.11 120100.0

4. INCIDENT CS / S99-00242			
5. INCIDENT LOCATION Oshkosh			
6. NAME LAST-FIRST-MI Anonymous		7. D.O.B.	
8. ADDRESS		9. TX-HOME	
11. CITY STATE ZIP		10. TX-BUSINESS	
12. DETAILS See Attached			

14. REC'D	15. DISP	16. 10-23	17. 10-24
13. DAY			
SUN 1	THU 5		
MON 2	FRI 6		
TUE 3	SAT 7		
WED 4			

INCIDENT CARD		
18. ASSIGNED MBSO		929 4411
19. REC. BY 935	20. DIS. BY	22. TYPE OF REPORT 1. INCIDENT 2. ACCIDENT 3. CITATION 4. NONE
21. HOW REC'D. 1. 911 2. POLICE RADIO 3. PHONE 4. TTY 5. IN PERSON 6. ON VIEW 7. OFF. OFF DUTY 8. C.B. RADIO 9. OTHER		23. STATUS 1. UNFOUNDED 2. PNL 3. OTHER 4. CLEARED 5. EXCEPT CLEARED
21A. M.O.		24. DATE CLEARED 10311699
		25. OFFENSE TYPE 1. ADULT <input type="checkbox"/> NA <input checked="" type="checkbox"/> 2. JUVENILE <input type="checkbox"/> 3. UNKNOWN <input type="checkbox"/>

39. (CODE S-SUSPECT W-WITNESS V-VICTIM O-OTHER)						
CODE	40. NAME-LAST	FIRST	MI	41. D.O.B.	42. ADDRESS	43. TELEPHONE

Unable to do any follow up. TTY sent to oshkosh PD
 No registration obtained, Oshkosh requested to be on the lookout, unable to locate, no further information at this time, Close Out. M.J. Bushman

MBS

45. IF COMPLAINANT DIFFERENT THEN CALLER, ENTER NAME, ADDRESS, D.O.B., TELEPHONE.

46. IF CODE O (OTHER) IS USED IN FIELD #39, EXPLAIN.

INCIDENT REPORT: NOTE: IF SECTION 22 ABOVE HAS NUMBER 4 CHECKED, DO NOT GO BEYOND THIS LINE WITHOUT RECORDS SECTION BEING ADVISED, OR NO RECORD ENTRIES WILL BE MADE BELOW THIS LINE.

PROPERTY VALUE	26. PROPERTY	A. CURRENCY	B. JEWELRY	C. FURS CLOTHING	D. VEHICLE (LOCAL)	E. OFFICE EQUIPMENT	F. RADIO, TV CAMERAS	G. FIREARMS	H. HOUSE-HOLD GOODS
	STOLEN	\$	\$	\$	\$	\$	\$	\$	\$
	RECOVERED	\$	\$	\$	\$	\$	\$	\$	\$
	26. PROPERTY	I. CONSUMABLES	J. LIVESTOCK	K. DRUGS	L. MARINE ITEMS	M. CONSTRUCTION ITEMS	N. LAWN AND GARDEN	O. SPORTING GOODS	P. MISC BICYCLE
STOLEN	\$	\$	\$	\$	\$	\$	\$	\$	
RECOVERED	\$	\$	\$	\$	\$	\$	\$	\$	

27. PROPERTY RECOVERED: LOCALLY _____ OTHER JURISDICTION _____ (INSERT O OR L)

PROPERTY ITEMIZATION	PROPERTY STOLEN/RECOVERED ITEMIZATION, USE THE FOLLOWING FORMAT				
	28. QUANTITY	29. ARTICLE NAME	30. BRAND NAME	31. SERIAL NUMBER	32. CODE
					S R <input type="checkbox"/> <input type="checkbox"/>
					S R <input type="checkbox"/> <input type="checkbox"/>
					S R <input type="checkbox"/> <input type="checkbox"/>
					S R <input type="checkbox"/> <input type="checkbox"/>

33. PROPERTY DAMAGE AMOUNT \$ _____ 34. INSURANCE COMPANY _____

35. OFFICER ASSAULTED Y N 36. ARSON Y N 37. STRUCTURE CODE _____ 38. DAMAGE \$ _____

47. CIB NCIC OTHER BROADCAST	ENTERED	CANCELLED	48. TOTAL AMOUNT PROPERTY STOLEN \$ _____
	<input type="checkbox"/>	<input type="checkbox"/>	
	<input type="checkbox"/>	<input type="checkbox"/>	
			49. TOTAL AMOUNT PROPERTY RECOVERED \$ _____

50. IS REPORT CONTINUED? YES NO 51. CAUTION INDICATORS, ATLS ETC.

52. DATA PROCESS INFORMATION:

COMPUTER ENTERED DATE 3/8/99

MICROFILM INDEXED INITIAL KS

IS CASE CLASSIFICATION CORRECT? Y N

IF N HAS CORRECTION BEEN MADE? Y N

53. FILE APPROVAL

BY [Signature] DATE 03/16/99

S99 No 00448 031011 131000

WANTAWOC COUNTY SHERIFF
INCIDENT CARD

4. INCIDENT
OS / S99-00242

5. INCIDENT LOCATION
South of Mishicot - StH 147

6. NAME- LAST-FIRST-MI
Anthony (2) 7. D.O.B.

8. ADDRESS 9. TX-HOME

11. CITY STATE ZIP 10. TX-BUSINESS

12. DETAILS
Rpts. BRO (BRO two tone. The

grill was smashed, and hood

bent in center. LP# JYH360

GMC SUBURBAN. - Attached

18. ASSIGNED Tisler H 7 9
9 2 9

19. REC. BY 938 20. DIS. BY 938
22. TYPE OF REPORT
1. INCIDENT
2. ACCIDENT
3. CITATION
4. NONE

21. HOW REC'D.
1. 911
2. POLICE RADIO
3. PHONE
4. TTY
5. IN PERSON
6. ON VIEW
7. OFF. OFF DUTY
8. C.B. RADIO
9. OTHER

23. STATUS
1. UNFOUNDED
2. PNL
3. OTHER
4. CLEARED
5. EXCEPT CLEARED

24. DATE CLEARED 03 18 99
25. OFFENSE TYPE
1. ADULT NA
2. JUVENILE
3. UNKNOWN

14. REC'D 15. DISP 16. 10-23 17. 10-24
13. DAY
SUN 1 THU 5
MON 2 FRI 6
TUE 3 SAT 7
WED 4

39. (CODE S-SUSPECT W-WITNESS V-VICTIM O-OTHER)				42. ADDRESS		43. TELEPHONE
CODE	40. NAME-LAST	FIRST	MI	41. D.O.B.		
O	HENDRIES	WALTER	J	[REDACTED]	[REDACTED] Pine Ridge Rd, Mishicot	

01/20/99: I, Deputy Tisler, II, was assigned to check 2 vehicles in the Mishicot area for damage that possibly would fit with what we are looking for the hit and run fatal on CTH CR.

The first location I checked was [REDACTED] Pine Ridge Rd, Mishicot. I made contact at the HENDRIES residence. They had a 1988 GMC Blazer which was bearing RP JYH360. I looked at the truck. The grill was intact. There was damage on the hood of the truck which appeared to be old damage. The grill along with the truck had the GMC emblems attached to it and did not have any Chevy emblems on it. The damage would not be consistent with what we are looking for.

The second location I checked was [REDACTED] Jambo Creek Rd. Information was that a truck was behind this residence missing a grill. I checked at this residence and located 2 older vehicles. Both vehicles were Ford products. Only one of the 2 vehicle was missing its grill. RTislerII /bjc

00440

45. IF COMPLAINANT DIFFERENT THEN CALLER, ENTER NAME, ADDRESS, D.O.B., TELEPHONE.

46. IF CODE O (OTHER) IS USED IN FIELD #39, EXPLAIN.

INCIDENT REPORT: NOTE: IF SECTION 22 ABOVE HAS NUMBER 4 CHECKED, DO NOT GO BEYOND THIS LINE WITHOUT RECORDS SECTION BEING ADVISED, OR NO RECORD ENTRIES WILL BE MADE BELOW THIS LINE.

PROPERTY VALUE	26. PROPERTY	A. CURRENCY	B. JEWELRY	C. FURS CLOTHING	D. VEHICLE (LOCAL)	E. OFFICE EQUIPMENT	F. RADIO, TV CAMERAS	G. FIREARMS	H. HOUSE-HOLD GOODS
	STOLEN	\$	\$	\$	\$	\$	\$	\$	\$
	RECOVERED	\$	\$	\$	\$	\$	\$	\$	\$
	26. PROPERTY	I. CONSUMABLES	J. LIVESTOCK	K. DRUGS	L. MARINE ITEMS	M. CONSTRUCTION ITEMS	N. LAWN AND GARDEN	O. SPORTING GOODS	P. MISC BICYCLE
	STOLEN	\$	\$	\$	\$	\$	\$	\$	\$
	RECOVERED	\$	\$	\$	\$	\$	\$	\$	\$

27. PROPERTY RECOVERED: LOCALLY _____ OTHER JURISDICTION _____ (INSERT O OR L)

PROPERTY ITEMIZATION	PROPERTY STOLEN/RECOVERED ITEMIZATION, USE THE FOLLOWING FORMAT			
	28. QUANTITY	29. ARTICLE NAME	30. BRAND NAME	31. SERIAL NUMBER

33. PROPERTY DAMAGE AMOUNT \$ _____

34. INSURANCE COMPANY _____

35. OFFICER ASSAULTED Y N

36. ARSON Y N

37. STRUCTURE CODE _____

38. DAMAGE \$ _____

47. CIB ENTERED CANCELLED
 NCIC
 OTHER BROADCAST

48. TOTAL AMOUNT PROPERTY STOLEN \$ _____

49. TOTAL AMOUNT PROPERTY RECOVERED \$ _____

50. IS REPORT CONTINUED? YES NO

51. CAUTION INDICATORS, ATLS ETC.

52. DATA PROCESS INFORMATION:

COMPUTER ENTERED DATE 3.8.99

MICROFILM INDEXED INITIAL KS

IS CASE CLASSIFICATION CORRECT? N
 IF N HAS CORRECTION BEEN MADE? N

53. FILE APPROVAL

BY 

DATE 03.08.99

OFFICE INFORMATION MEMO

Rec'd by:

Please:

And:

Date 1-20-89 Time _____

To: Bush

From: Tom Blake

Telephone: [REDACTED]

- | | |
|--|------------------------------------|
| <input type="checkbox"/> Comment | <input type="checkbox"/> Return |
| <input type="checkbox"/> Note | <input type="checkbox"/> Info Only |
| <input type="checkbox"/> See Me | |
| <input type="checkbox"/> Investigate | |
| <input type="checkbox"/> Take Necessary Action | |
| <input type="checkbox"/> Approve | <input type="checkbox"/> |
| <input type="checkbox"/> Sign | <input type="checkbox"/> |
| <input type="checkbox"/> Revise | <input type="checkbox"/> |
| <input type="checkbox"/> Correct | <input type="checkbox"/> |
| <input type="checkbox"/> Reply Directly | <input type="checkbox"/> |
| <input type="checkbox"/> Route to: | <input type="checkbox"/> |

Please Call Will call again

Called to see you

Remarks/Messages. *works for city & was hauling sand from Radon to pit & seen 80's truck parked behind [REDACTED] Samba Creek rd. with grill missing. Address may be neighbor but truck can be seen.*

S99-00457 631011 52000

MANITOWOC COUNTY SHERIFF
INCIDENT CARD

4. INCIDENT
CS/S99-00242

5. INCIDENT LOCATION

6. NAME - LAST - FIRST - MI
Anonymous

7. D.O.B.

8. ADDRESS

9. TX-HOME

11. CITY STATE ZIP

10. TX-BUSINESS

12. DETAILS
See Attached

FILE 66/5/10

18 ASSIGNED
MISO
Bushman
ADP
H/M

19. REC. BY
935

20. DIS. BY

22. TYPE OF REPORT
1. INCIDENT
2. ACCIDENT
3. CITATION
4. NONE

21. HOW REC'D.
1. 911
2. POLICE RADIO
3. PHONE
4. TTY
5. IN PERSON
6. ON VIEW
7. OFF. OFF DUTY
8. C.B. RADIO
9. OTHER

23. STATUS
1. UNFOUNDED
2. PNL
3. OTHER
4. CLEARED
5. EXCEPT CLEARED

24. DATE
CLEARED 01/21/99

25. OFFENSE TYPE
1. ADULT NA
2. JUVENILE
3. UNKNOWN

14. REC'D

15. DISP

16. 10-23

17. 10-24

13. DAY
SUN 1 THU 5
MON 2 FRI 6
TUE 3 SAT 7
WED 4

39. (CODE S-SUSPECT W-WITNESS V-VICTIM O-OTHER)						
CODE	40. NAME-LAST	FIRST	MI	41. D.O.B.	42. ADDRESS	43. TELEPHONE
S	Bryant, Robert L.				North Ave. Cleveland	

01/16/98 The party described is Robert Bryant. This vehicle was checked early in the investigation by myself, Lt. Bushman. There was no damage. M.J. Bushman

45. IF COMPLAINANT DIFFERENT THEN CALLER, ENTER NAME, ADDRESS, D.O.B., TELEPHONE.

46. IF CODE O (OTHER) IS USED IN FIELD #39, EXPLAIN.

INCIDENT REPORT: NOTE: IF SECTION 22 ABOVE HAS NUMBER 4 CHECKED, DO NOT GO BEYOND THIS LINE WITHOUT RECORDS SECTION BEING ADVISED, OR NO RECORD ENTRIES WILL BE MADE BELOW THIS LINE.

PROPERTY VALUE	26. PROPERTY	A. CURRENCY	B. JEWELRY	C. FURS CLOTHING	D. VEHICLE (LOCAL)	E. OFFICE EQUIPMENT	F. RADIO, TV CAMERAS	G. FIREARMS	H. HOUSE-HOLD GOODS
	STOLEN	\$	\$	\$	\$	\$	\$	\$	\$
	RECOVERED	\$	\$	\$	\$	\$	\$	\$	\$
	26. PROPERTY	I. CONSUMABLES	J. LIVESTOCK	K. DRUGS	L. MARINE ITEMS	M. CONSTRUCTION ITEMS	N. LAWN AND GARDEN	O. SPORTING GOODS	P. MISC BICYCLE
	STOLEN	\$	\$	\$	\$	\$	\$	\$	\$
	RECOVERED	\$	\$	\$	\$	\$	\$	\$	\$

27. PROPERTY RECOVERED: LOCALLY ____ OTHER JURISDICTION ____ (INSERT O OR L)

PROPERTY ITEMIZATION	PROPERTY STOLEN/RECOVERED ITEMIZATION, USE THE FOLLOWING FORMAT				
	28. QUANTITY	29. ARTICLE NAME	30. BRAND NAME	31. SERIAL NUMBER	
					S R <input type="checkbox"/> <input type="checkbox"/>
					S R <input type="checkbox"/> <input type="checkbox"/>
					S R <input type="checkbox"/> <input type="checkbox"/>
					S R <input type="checkbox"/> <input type="checkbox"/>
					S R <input type="checkbox"/> <input type="checkbox"/>

33. PROPERTY DAMAGE AMOUNT \$ _____

34. INSURANCE COMPANY _____

35. OFFICER ASSAULTED Y N

36. ARSON Y N

37. STRUCTURE CODE _____

38. DAMAGE \$ _____

47. CIB ENTERED CANCELLED
 NCIC
 OTHER BROADCAST

48. TOTAL AMOUNT PROPERTY STOLEN \$ _____

49. TOTAL AMOUNT PROPERTY RECOVERED \$ _____

50. IS REPORT CONTINUED? YES NO

51. CAUTION INDICATORS, ATLS ETC.

52. DATA PROCESS INFORMATION:

COMPUTER ENTERED DATE 01/21/99
 MICROFILM INDEXED INITIAL AS

53. FILE APPROVAL

IS CASE CLASSIFICATION CORRECT? N
 IF N HAS CORRECTION BEEN MADE? N

BY  DATE 01/21/99

CASE # S99 No 00468 6301 52000

4. INCIDENT CS/599-00242

5. INCIDENT LOCATION 4 SEASONS

6. NAME - LAST - FIRST - MI ANONYMOUS (2) 7. D.O.B.

8. ADDRESS 9. TX-HOME

11. CITY STATE ZIP 10. TX-BUSINESS

INCIDENT CARD

18. ASSIGNED CRIME 929
STOPPERS

19. REC. BY 945 20. DIS. BY

22. TYPE OF REPORT
 1. INCIDENT
 2. ACCIDENT
 3. CITATION
 4. NONE

21. HOW REC'D.
 1. 911
 2. POLICE RADIO
 3. PHONE
 4. TTY
 5. IN PERSON
 6. ON VIEW
 7. OFF. OFF DUTY
 8. C.B. RADIO
 9. OTHER

23. STATUS
 1. UNFOUNDED
 2. PNL
 3. OTHER
 4. CLEARED
 5. EXCEPT CLEARED

24. DATE CLEARED 10/21/99

25. OFFENSE TYPE
 1. ADULT NA
 2. JUVENILE
 3. UNKNOWN

12. DETAILS: States they saw a GMC Jimmy w/ front end damage (grill. Info on H/R fatal) Plate # HUSKE

14. REC'D	15. DISP	16. 10-23	17. 10-24
13. DAY			
SUN 1	THU 5		
MON 2	FRI 6		
TUE 3	SAT 7		
WED 4			

34. (CODE S-SUSPECT W-WITNESS V-VICTIM O-OTHER)						
CODE	40. NAME-LAST	FIRST	MI	41. D.O.B.	42. ADDRESS	43. TELEPHONE

01/20/99 Vehicle does not fit the profile of suspect. M.J. Bushman *MJB*

45. IF COMPLAINANT DIFFERENT THEN CALLER, ENTER NAME, ADDRESS, D.O.B., TELEPHONE.

46. IF CODE O (OTHER) IS USED IN FIELD #39, EXPLAIN.

INCIDENT REPORT: NOTE: IF SECTION 22 ABOVE HAS NUMBER 4 CHECKED, DO NOT GO BEYOND THIS LINE WITHOUT RECORDS SECTION BEING ADVISED, OR NO RECORD ENTRIES WILL BE MADE BELOW THIS LINE.

PROPERTY VALUE	26. PROPERTY	A. CURRENCY	B. JEWELRY	C. FURS CLOTHING	D. VEHICLE (LOCAL)	E. OFFICE EQUIPMENT	F. RADIO, TV CAMERAS	G. FIREARMS	H. HOUSE-HOLD GOODS
	STOLEN	\$	\$	\$	\$	\$	\$	\$	\$
	RECOVERED	\$	\$	\$	\$	\$	\$	\$	\$
	26. PROPERTY	I. CONSUMABLES	J. LIVESTOCK	K. DRUGS	L. MARINE ITEMS	M. CONSTRUCTION ITEMS	N. LAWN AND GARDEN	O. SPORTING GOODS	P. MISC BICYCLE
STOLEN	\$	\$	\$	\$	\$	\$	\$	\$	
RECOVERED	\$	\$	\$	\$	\$	\$	\$	\$	

27. PROPERTY RECOVERED: LOCALLY _____ OTHER JURISDICTION _____ (INSERT O OR L)

PROPERTY ITEMIZATION	PROPERTY STOLEN/RECOVERED ITEMIZATION, USE THE FOLLOWING FORMAT				
	28. QUANTITY	29. ARTICLE NAME	30. BRAND NAME	31. SERIAL NUMBER	32. CODE
					S R <input type="checkbox"/> <input type="checkbox"/>
					S R <input type="checkbox"/> <input type="checkbox"/>
					S R <input type="checkbox"/> <input type="checkbox"/>
					S R <input type="checkbox"/> <input type="checkbox"/>
					S R <input type="checkbox"/> <input type="checkbox"/>
					S R <input type="checkbox"/> <input type="checkbox"/>

33. PROPERTY DAMAGE AMOUNT \$ _____

34. INSURANCE COMPANY _____

35. OFFICER ASSAULTED Y N

36. ARSON Y N

37. STRUCTURE CODE _____

38. DAMAGE \$ _____

47. CIB ENTERED CANCELLED
 NCIC
 OTHER BROADCAST

48. TOTAL AMOUNT PROPERTY STOLEN \$ _____

49. TOTAL AMOUNT PROPERTY RECOVERED \$ _____

50. IS REPORT CONTINUED? YES NO

51. CAUTION INDICATORS, ATLS ETC.

52. DATA PROCESS INFORMATION:

COMPUTER ENTERED DATE 01/21/99
 MICROFILM INDEXED INITIAL KS

53. FILE APPROVAL

BY [Signature]

DATE 01/21/99

IS CASE CLASSIFICATION CORRECT?
 IF N HAS CORRECTION BEEN MADE? Y N

S99 No 00471 | 63011 | 52000

4. INCIDENT
CS/S99-00242

5. INCIDENT LOCATION
Larry's Shell

6. NAME - LAST / FIRST - MI
Anony.

7. D.O.B.

8. ADDRESS

9. TX-HOME

11. CITY STATE ZIP

10. TX-BUSINESS

12. DETAILS
Veh was at Larry's Shell
10 min ago - full sz. GMC
Truck w/ passenger side grill
damaged, # A-42500. Vehicle
left Northbound on 41st St.
Driver: m/w, mid 30's, dk hair

14. REC'D	15. DISP	16. 10-23	17. 10-24
13. DAY			
SUN 1	THU 5		
MON 2	FRI 6		
TUE 3	SAT 7		
WED 4			

MANITOWOC COUNTY SHERIFF
INCIDENT CARD

18. ASSIGNED
MTPD 925

19. REC. BY
920

20. DIS. BY

21. HOW REC'D.
1. 911
2. POLICE RADIO
3. PHONE
4. TTY
5. IN PERSON
6. ON VIEW
7. OFF. OFF DUTY
8. C.B. RADIO
9. OTHER

22. TYPE OF REPORT
1. INCIDENT
2. ACCIDENT
3. CITATION
4. NONE

23. STATUS
1. UNFOUNDED
2. PNL
3. OTHER
4. CLEARED
5. EXCEPT CLEARED

24. DATE CLEARED
031899

25. OFFENSE TYPE
1. ADULT NA
2. JUVENILE
3. UNKNOWN

21A. M.O.

39. (CODE S-SUSPECT W-WITNESS V-VICTIM O-OTHER)				41. D.O.B.	42. ADDRESS	43. TELEPHON
CODE	40. NAME-LAST	FIRST	MI			

and had a small child with him, 10-13 yoa. sbraun920

01-16-99 10-28s were run on truck plates "AA42500 thru AK42500" and only one came back to a Manitowoc address (AJ42500). Info passed on to MTPD to check. sbraun920

Vehicle does not match

45. IF COMPLAINANT DIFFERENT THEN CALLER, ENTER NAME, ADDRESS, D.O.B., TELEPHONE.

46. IF CODE O (OTHER) IS USED IN FIELD #39, EXPLAIN.

INCIDENT REPORT: NOTE: IF SECTION 22 ABOVE HAS NUMBER 4 CHECKED, DO NOT GO BEYOND THIS LINE WITHOUT RECORDS SECTION BEING ADVISED, OR NO RECORD ENTRIES WILL BE MADE BELOW THIS LINE.

PROPERTY VALUE	26. PROPERTY	A. CURRENCY	B. JEWELRY	C. FURS CLOTHING	D. VEHICLE (LOCAL)	E. OFFICE EQUIPMENT	F. RADIO, TV CAMERAS	G. FIREARMS	H. HOUSE-HOLD GOODS
	STOLEN	\$	\$	\$	\$	\$	\$	\$	\$
	RECOVERED	\$	\$	\$	\$	\$	\$	\$	\$
	26. PROPERTY	I. CONSUMABLES	J. LIVESTOCK	K. DRUGS	L. MARINE ITEMS	M. CONSTRUCTION ITEMS	N. LAWN AND GARDEN	O. SPORTING GOODS	P. MISC BICYCLE
STOLEN	\$	\$	\$	\$	\$	\$	\$	\$	
RECOVERED	\$	\$	\$	\$	\$	\$	\$	\$	

27. PROPERTY RECOVERED: LOCALLY _____ OTHER JURISDICTION _____ (INSERT O OR L)

PROPERTY ITEMIZATION	PROPERTY STOLEN/RECOVERED ITEMIZATION, USE THE FOLLOWING FORMAT				
	28. QUANTITY	29. ARTICLE NAME	30. BRAND NAME	31. SERIAL NUMBER	32. CODE
					S R <input type="checkbox"/> <input type="checkbox"/>
					S R <input type="checkbox"/> <input type="checkbox"/>
					S R <input type="checkbox"/> <input type="checkbox"/>
					S R <input type="checkbox"/> <input type="checkbox"/>

33. PROPERTY DAMAGE AMOUNT \$ _____ 34. INSURANCE COMPANY _____

35. OFFICER ASSAULTED Y N 36. ARSON Y N 37. STRUCTURE CODE _____ 38. DAMAGE \$ _____

47. CIB ENTERED CANCELLED
 NCIC
 OTHER BROADCAST

48. TOTAL AMOUNT PROPERTY STOLEN \$ _____

49. TOTAL AMOUNT PROPERTY RECOVERED \$ _____

50. IS REPORT CONTINUED? YES NO

51. CAUTION INDICATORS, ATLS ETC.

52. DATA PROCESS INFORMATION:

COMPUTER ENTERED DATE 3.8.99
 MICROFILM INDEXED INITIAL KS

53. FILE APPROVAL

IS CASE CLASSIFICATION CORRECT?
 IF N HAS CORRECTION BEEN MADE?

BY [Signature] DATE 03/08/99

S99 NY UU40J | 4310.11 | 1,410,0,2

4. INCIDENT CS / S99-00242

5. INCIDENT LOCATION [REDACTED] CTH CR

6. NAME - LAST - FIRST - MI ANONY. (2) 7. D.O.B.

8. ADDRESS [REDACTED] 9. TX-HOME

11. CITY STATE ZIP 10. TX-BUSINESS

12. DETAILS
 Rpts. BRAD KUGEL # [REDACTED]
 WHO OWNS COUNTRY SIDE Auto
 [REDACTED] CTHCR OWNS A 87 CHEV
 TK LIGHT TAN IN COLOR.

INCIDENT CARD

18. ASSIGNED INFO 91811
 LT. BUSHMAN 41411

19. REC. BY 938 20. DIS. BY

21. HOW REC'D.
 1. 911
 2. POLICE RADIO
 3. PHONE
 4. TTY
 5. IN PERSON
 6. ON VIEW
 7. OFF. OFF DUTY
 8. C.B. RADIO
 9. OTHER

22. TYPE OF REPORT
 1. INCIDENT
 2. ACCIDENT
 3. CITATION
 4. NONE

23. STATUS
 1. UNFOUNDED
 2. PNL
 3. OTHER
 4. CLEARED
 5. EXCEPT CLEARED

24. DATE CLEARED 10/18/99

25. OFFENSE TYPE
 1. ADULT NA
 2. JUVENILE
 3. UNKNOWN

21A. M.O.

14. REC'D	15. DISP	16. 10-23	17. 10-24
13. DAY			
SUN 1	THU 5		
MON 2	FRI 6		
TUE 3	SAT 7		
WED 4			

39. (CODE S-SUSPECT W-WITNESS V-VICTIM O-OTHER)						
CODE	40. NAME-LAST	FIRST	MI	41. D.O.B.	42. ADDRESS	43. TELEPHONE

01-16-99 con't... He also has access to other vehs. because of auto dealership. Party states that the above veh. has not been seen in area since fatal accident. KUGEL would reside at above loc. in a mobile home. 938/KB KB

01/17/99 All vehicles in this lot had been checked the night of the accident and again the following day and night. There had been no fresh tire tracks the night of the incident and the only two vehicles in the lot which matched the suspect vehicle did not have any front end damage. M.J. Bushman

10
11
12
13
14
15
16
17
18
19
20
21
22
23
24
25
26
27
28
29
30
31
32
33
34
35
36
37
38
39
40
41
42
43
44
45
46
47
48
49
50

45. IF COMPLAINANT DIFFERENT THEN CALLER, ENTER NAME, ADDRESS, D.O.B., TELEPHONE.

46. IF CODE O (OTHER) IS USED IN FIELD #39, EXPLAIN.

INCIDENT REPORT: NOTE: IF SECTION 22 ABOVE HAS NUMBER 4 CHECKED, DO NOT GO BEYOND THIS LINE WITHOUT RECORDS SECTION BEING ADVISED, OR NO RECORD ENTRIES WILL BE MADE BELOW THIS LINE.

PROPERTY VALUE	26. PROPERTY	A. CURRENCY	B. JEWELRY	C. FURS CLOTHING	D. VEHICLE (LOCAL)	E. OFFICE EQUIPMENT	F. RADIO, TV CAMERAS	G. FIREARMS	H. HOUSE-HOLD GOODS
	STOLEN	\$	\$	\$	\$	\$	\$	\$	\$
	RECOVERED	\$	\$	\$	\$	\$	\$	\$	\$
	26. PROPERTY	I. CONSUMABLES	J. LIVESTOCK	K. DRUGS	L. MARINE ITEMS	M. CONSTRUCTION ITEMS	N. LAWN AND GARDEN	O. SPORTING GOODS	P. MISC BICYCLE
	STOLEN	\$	\$	\$	\$	\$	\$	\$	\$
	RECOVERED	\$	\$	\$	\$	\$	\$	\$	\$

27. PROPERTY RECOVERED: LOCALLY _____ OTHER JURISDICTION _____ (INSERT O OR L)

PROPERTY ITEMIZATION	PROPERTY STOLEN/RECOVERED ITEMIZATION, USE THE FOLLOWING FORMAT				
	28. QUANTITY	29. ARTICLE NAME	30. BRAND NAME	31. SERIAL NUMBER	32. CODE
					S <input type="checkbox"/> R <input type="checkbox"/>
					S <input type="checkbox"/> R <input type="checkbox"/>
					S <input type="checkbox"/> R <input type="checkbox"/>
					S <input type="checkbox"/> R <input type="checkbox"/>
					S <input type="checkbox"/> R <input type="checkbox"/>

33. PROPERTY DAMAGE AMOUNT \$ _____

34. INSURANCE COMPANY _____

35. OFFICER ASSAULTED Y N 36. ARSON Y N 37. STRUCTURE CODE _____ 38. DAMAGE \$ _____

47. CIB ENTERED CANCELLED
 NCIC
 OTHER BROADCAST

48. TOTAL AMOUNT PROPERTY STOLEN \$ _____

49. TOTAL AMOUNT PROPERTY RECOVERED \$ _____

50. IS REPORT CONTINUED? YES NO

51. CAUTION INDICATORS, ATLS ETC.

52. DATA PROCESS INFORMATION:

COMPUTER ENTERED DATE 01/18/99
 MICROFILM INDEXED INITIAL AS

53. FILE APPROVAL

IS CASE CLASSIFICATION CORRECT? N
 IF N HAS CORRECTION BEEN MADE? N

BY QR DATE 01/18/99

S99 No 00476 | 6301 | 52000

MANITOWOC COUNTY SHERIFF
INCIDENT CARD

4. INCIDENT ID: CS | S99 00242

5. INCIDENT LOCATION: 26th & Silver Creek Rd.

6. NAME - LAST-FIRST-MI: Anonymous | 7. D.O.B.

8. ADDRESS | 9. TX-HOME

11. CITY | STATE | ZIP | 10. TX-BUSINESS

12. DETAILS: See Attached.

18. ASSIGNED: MBS | 929
Bushman | 441

19. REC. BY: 935 | 20. DIS. BY:

21. HOW REC'D.
1. 911
2. POLICE RADIO
3. PHONE
4. TTY
5. IN PERSON
6. ON VIEW
7. OFF. OFF DUTY
8. C.B. RADIO
9. OTHER

22. TYPE OF REPORT
1. INCIDENT
2. ACCIDENT
3. CITATION
4. NONE

23. STATUS
1. UNFOUNDED
2. PNL
3. OTHER
4. CLEARED
5. EXCEPT CLEARED

24. DATE CLEARED: 10/12/99

25. OFFENSE TYPE
1. ADULT NA
2. JUVENILE
3. UNKNOWN

21A. M.O.

14. REC'D | 15. DISP | 16. 10-23 | 17. 10-24

13. DAY
SUN 1 | THU 5
MON 2 | FRI 6
TUE 3 | SAT 7
WED 4

39. (CODE S-SUSPECT W-WITNESS V-VICTIM O-OTHER)				41. D.O.B.	42. ADDRESS	43. TELEPHONE
CODE	40. NAME-LAST	FIRST	MI			
O	RATAJCZAK	RICKY	D	[REDACTED]	[REDACTED] Silver Creek Rd, Manitowoc	

01/16/99 @ 2200 Hrs.: I, Lt. M. Bushman, was cruising the area, looking for the vehicle described in this complaint. I observed a blue 1986 Chevrolet pickup with a cap--farm RP 22570F. This comes back to the RICHARD RATAJCZAK farm at [REDACTED] Silver Creek Rd, Manitowoc.

While I got out to observe the caved-in grill, RICKY RATAJCZAK left the residence and came to speak with officers. There was damage to the front grill of the truck; however, there was no damage to the hood or metal edges or anywhere other than just the grill being pushed in. Some of the pieces in the grill were not missing when compared to the parts that were collected. The tire design is different. The damage is not sufficient for the type of impact. This is not the suspect vehicle.

Officers spoke with RICKY who stated that since the accident happened, he was afraid too many people would stop and comment about his smashed grill which happened approximately 1 year ago. He kept the vehicle inside until recently and toyed with the idea of calling police to have them come and check it off the list. He was fully understanding that officers needed to check the grill. MJBushman /bjc

[Handwritten signature]

45. IF COMPLAINANT DIFFERENT THEN CALLER, ENTER NAME, ADDRESS, D.O.B., TELEPHONE.

46. IF CODE O (OTHER) IS USED IN FIELD #39, EXPLAIN.

INCIDENT REPORT: NOTE: IF SECTION 22 ABOVE HAS NUMBER 4 CHECKED, DO NOT GO BEYOND THIS LINE WITHOUT RECORDS SECTION BEING ADVISED, OR NO RECORD ENTRIES WILL BE MADE BELOW THIS LINE.

PROPERTY VALUE	26. PROPERTY	A. CURRENCY	B. JEWELRY	C. FURS CLOTHING	D. VEHICLE (LOCAL)	E. OFFICE EQUIPMENT	F. RADIO, TV CAMERAS	G. FIREARMS	H. HOUSE-HOLD GOODS
	STOLEN	\$	\$	\$	\$	\$	\$	\$	\$
	RECOVERED	\$	\$	\$	\$	\$	\$	\$	\$
	26. PROPERTY	I. CONSUM-ABLES	J. LIVESTOCK	K. DRUGS	L. MARINE ITEMS	M. CONSTRUCTION ITEMS	N. LAWN AND GARDEN	O. SPORTING GOODS	P. MISC BICYCLE
	STOLEN	\$	\$	\$	\$	\$	\$	\$	\$
	RECOVERED	\$	\$	\$	\$	\$	\$	\$	\$

27. PROPERTY RECOVERED: LOCALLY _____ OTHER JURISDICTION _____ (INSERT O OR L)

PROPERTY ITEMIZATION	PROPERTY STOLEN/RECOVERED ITEMIZATION, USE THE FOLLOWING FORMAT				
	28. QUANTITY	29. ARTICLE NAME	30. BRAND NAME	31. SERIAL NUMBER	32. CODE
					S R <input type="checkbox"/> <input type="checkbox"/>
					S R <input type="checkbox"/> <input type="checkbox"/>
					S R <input type="checkbox"/> <input type="checkbox"/>
					S R <input type="checkbox"/> <input type="checkbox"/>
					S R <input type="checkbox"/> <input type="checkbox"/>

33. PROPERTY DAMAGE AMOUNT \$ _____ 34. INSURANCE COMPANY _____

35. OFFICER ASSAULTED Y N 36. ARSON Y N 37. STRUCTURE CODE _____ 38. DAMAGE \$ _____

47. CIB	ENTERED <input type="checkbox"/>	CANCELLED <input type="checkbox"/>	48. TOTAL AMOUNT PROPERTY STOLEN \$ _____
NCIC	<input type="checkbox"/>	<input type="checkbox"/>	
OTHER BROADCAST	<input type="checkbox"/>	<input type="checkbox"/>	
			49. TOTAL AMOUNT PROPERTY RECOVERED \$ _____

50. IS REPORT CONTINUED? YES NO

51. CAUTION INDICATORS, ATLS ETC.

52. DATA PROCESS INFORMATION:

COMPUTER ENTERED DATE 01/20/99
 MICROFILM INDEXED INITIAL RS

53. FILE APPROVAL
 BY GR DATE 01/20/99

IS CASE CLASSIFICATION CORRECT?
 IF N HAS CORRECTION BEEN MADE? Y N

S99 No 00490 | 5.7.15 | 70,000

4. INCIDENT *Rec-info / S99-00242*

5. INCIDENT LOCATION

6. NAME LAST-FIRST-MI *CASO* 7. D.O.B.

8. ADDRESS 9. TX-HOME

11. CITY STATE ZIP 10. TX-BUSINESS

12. DETAILS
INFO REC'D ON S99-00242

WISCONSIN COUNTY SHERIFF
INCIDENT CARD

18. ASSIGNED
AT BUSHMAN H.H.T
SGT-BEILKE 492
COLBORN H32

19. REC. BY *923* 20. DIS. BY

22. TYPE OF REPORT
1. INCIDENT
2. ACCIDENT
3. CITATION
4. NONE

21. HOW REC'D.
1. 911
2. POLICE RADIO
3. PHONE
4. TTY
5. IN PERSON
6. ON VIEW
7. OFF. OFF DUTY
8. C.B. RADIO
9. OTHER

23. STATUS
1. UNFOUNDED
2. PNL
3. OTHER
4. CLEARED
5. EXCEPT CLEARED

24. DATE CLEARED *10/28/99*

25. OFFENSE TYPE
1. ADULT NA
2. JUVENILE
3. UNKNOWN

14. REC'D	15. DISP	16. 10-23	17. 10-24
13. DAY			
SUN 1		THU 5	
MON 2		FRI 6	
TUE 3		SAT 7	
WED 4			

39. (CODE S-SUSPECT W-WITNESS V-VICTIM O-OTHER)						
CODE	40. NAME-LAST	FIRST	MI	41. D.O.B.	42. ADDRESS	43. TELEPHONE
0	Zylka, Brenda J.	<i>195326</i>			<i>CTH H Chilton, WI 53014</i>	

01-17-99 @ 0845 hrs I received a phone call from Officer Pagels of the Calumet County Sheriff's Dept. in reference to our investigation of the fatal H & R that happened in our county. At this time he indicated that he had some information that may or may not turn out to be something. He informed me that he himself used to own a vehicle matching that description. He stated that this would have been a 1985 Chevrolet Suburban, blue in color with a grey stripe down the side. He went on to state that he would sold the vehicle to a female by the name of Brenda J. Zylka *CTH H Chilton, WI 53014*. He stated that Brenda is a exotic dancer/stripper and may have been working in our area, but he does not know for sure. He stated that he has not seen this vehicle in the area or parked at her residence since the report of the accident. Pagels went on to state, *what was* he really felt was out of the ordinary, was that he recently had seen Brenda Zylka in the area and had a chance to speak with her. He stated that he was just goofing around and had mentioned something about the incident and her Suburban. He stated she immediately stated that the vehicle had broken down somewhere up north on November 9th. Pagels felt that this was *kinda* strange that she would recall the exact date that this would have occurred and at how fast that she had responded with this statement.

Officer Pagels stated that he feels somebody should check on this vehicle and/or it's whereabouts. He stated that he does not want his name brought up to Zylka that he provided any of this information. Pagels stated that if any investigating officer needed to speak with him in regards to this info, they could contact CASO. I do not recall if Pagels knew the exact whereabouts of the vehicle at this time, but stated that somebody could talk to Zylka and inform her we were checking vehicles in the area as a result of our investigation and could contact the jurisdiction where the *vehicle* currently was being kept to check on it. Pagels stated that her residence would be around the New Holstein area which could put her choice for her direction of travel home, through the scene and along the suspected direction of travel after the accident.

Sgt. T. Beilke

01/17/99: I, Deputy A. Colborn, was briefed on this incident by Sgt. T. Beilke. Sgt. Beilke suggested I run an alpha check which would reveal any vehicles registered to BRENDA ZYLKA.

45. IF COMPLAINANT DIFFERENT THEN CALLER, ENTER NAME, ADDRESS, D.O.B., TELEPHONE.

46. IF CODE O (OTHER) IS USED IN FIELD #39, EXPLAIN.

INCIDENT REPORT: NOTE: IF SECTION 22 ABOVE HAS NUMBER 4 CHECKED, DO NOT GO BEYOND THIS LINE WITHOUT RECORDS SECTION BEING ADVISED, OR NO RECORD ENTRIES WILL BE MADE BELOW THIS LINE.

PROPERTY VALUE	26. PROPERTY	A. CURRENCY	B. JEWELRY	C. FURS CLOTHING	D. VEHICLE (LOCAL)	E. OFFICE EQUIPMENT	F. RADIO, TV CAMERAS	G. FIREARMS	H. HOUSE-HOLD GOODS
	STOLEN	\$	\$	\$	\$	\$	\$	\$	\$
	RECOVERED	\$	\$	\$	\$	\$	\$	\$	\$
	26. PROPERTY	I. CONSUM-ABLES	J. LIVESTOCK	K. DRUGS	L. MARINE ITEMS	M. CONSTRUCTION ITEMS	N. LAWN AND GARDEN	O. SPORTING GOODS	P. MISC BICYCLE
	STOLEN	\$	\$	\$	\$	\$	\$	\$	\$
	RECOVERED	\$	\$	\$	\$	\$	\$	\$	\$

27. PROPERTY RECOVERED: LOCALLY _____ OTHER JURISDICTION _____ (INSERT O OR L)

PROPERTY ITEMIZATION	PROPERTY STOLEN/RECOVERED ITEMIZATION, USE THE FOLLOWING FORMAT				
	28. QUANTITY	29. ARTICLE NAME	30. BRAND NAME	31. SERIAL NUMBER	32. CODE
					S R <input type="checkbox"/> <input type="checkbox"/>
					S R <input type="checkbox"/> <input type="checkbox"/>
					S R <input type="checkbox"/> <input type="checkbox"/>
					S R <input type="checkbox"/> <input type="checkbox"/>

33. PROPERTY DAMAGE AMOUNT \$ _____ 34. INSURANCE COMPANY _____

35. OFFICER ASSAULTED Y N 36. ARSON Y N 37. STRUCTURE CODE _____ 38. DAMAGE \$ _____

47. CIB NCIC OTHER BROADCAST	ENTERED	CANCELLED	48. TOTAL AMOUNT PROPERTY STOLEN \$ _____
	<input type="checkbox"/>	<input type="checkbox"/>	
	<input type="checkbox"/>	<input type="checkbox"/>	
			49. TOTAL AMOUNT PROPERTY RECOVERED \$ _____

50. IS REPORT CONTINUED? YES NO 51. CAUTION INDICATORS, ATLS ETC.

52. DATA PROCESS INFORMATION:

COMPUTER ENTERED DATE 10/29/99

MICROFILM INDEXED INITIAL RS

IS CASE CLASSIFICATION CORRECT? IF N HAS CORRECTION BEEN MADE? Y N

53. FILE APPROVAL
BY WRS DATE 11/25/99

MANITOWOC COUNTY SHERIFF'S DEPARTMENT
FOLLOW-UP REPORT

Page: 2

CASE NUMBER: 599-00490 CLASSIFICATION: _____

INCIDENT: _____

DATE AND TIME: _____

REPORT CONTINUED:

An alpha check was performed which revealed a 1988 Chevy truck bearing WI RP BK30649 was registered to BRENDA ZYLKA.

I, Deputy Colborn, responded to the City of Chilton in Calumet Co. where I made contact with Officer Pagels. Officer Pagels advised he sold BRENDA ZYLKA a Chevy Suburban. He further advised he had been informed by ZYLKA that the vehicle became disabled "up north." ZYLKA was not precise on the location where the vehicle became disabled. Officer Pagels stated he asked ZYLKA what the nature of the problem with the vehicle was. She stated "the engine blew." Officer Pagels stated he thought this was odd because he knew ZYLKA put a new engine in the Suburban and did not feel this engine could possibly have worn out in the short length of time it was in the vehicle.

Lt. M. Bushman and I made several checks at [REDACTED] CTH H, Chilton, which is in Calumet Co. in an attempt to locate ZYLKA or her Chevy Suburban. Each time we checked the residence, she was unable to be located. No one was at the residence at this time.

We also checked with ZYLKA'S employer which we found to be BEESCHEL STONE. They stated ZYLKA works on 01/18/99, starting at 0645 hours and working until approximately 1530 hours.

No further action taken by myself at this time. Pending weather conditions, Lt. Bushman stated he will attempt contact with ZYLKA during the 2000-0400-hour shift (see his addition to this report).

It should be noted, while speaking with Officer Pagels, I specifically asked him if he thought ZYLKA was the type of person who could run someone over and then leave them lying there without contacting anyone. Officer Pagels' answer to the question was, "It wouldn't surprise me in the least."

Further follow-up will be conducted by Lt. Bushman. ALColborn *ALC* /bjc

01/17/99 @ 1430 Hrs.: I, Lt. M. Bushman, received a phone call from Deputy A. Colborn at my residence reference a possible tip as to the location of a fatal hit and run vehicle.

A phone call was placed from Officer Pagels of CASO to MTSO reference an investigation of the hit and run accident. Officer Pagels stated he used to own a vehicle matching the description. The vehicle would have been a 1985 Chevy Suburban, blue with a gray strip down the side. He went on to state he sold the vehicle to a female by the name of BRENDA ZYLKA who resides at [REDACTED] CTH H, Chilton. He stated ZYLKA is an exotic dancer/stripper and may have been working in our area; however, he does not know this for sure. He stated he has not seen the vehicle in the area or parked at her residence since the reported accident.

Officer Pagels went on to state he recently ran into ZYLKA and had a chance to speak with her. He stated he was "just goofing around" and mentioned something about the incident and his Suburban. She immediately stated the vehicle was broken down somewhere up north and that this should have occurred on 11/09/98. Officer Pagels felt it was quite strange as

MANITOWOC COUNTY SHERIFF'S DEPARTMENT
FOLLOW-UP REPORT

Page: 3

CASE NUMBER: 599-00490 CLASSIFICATION: _____

INCIDENT: _____

DATE AND TIME: _____

REPORT CONTINUED:

she would recall the exact date of the occurrence. He thought it would be a good idea if we attempted contact and verified that the vehicle has no damaged.

01/17/99 @ 1500 Hrs.: I, Lt. Bushman, along with Deputy Colborn attempted contact at [REDACTED] CTH H, Chilton. There was no answer at the door. There were no vehicles in the yard. One small car was in the garage which apparently does not get used very often. It was learned ZYLKA would be working at BEUCHAL STONE on CTH H, approximately 3 miles to the east.

Contact was made at BEUCHAL STONE with a secretary who happened to be there doing paperwork. She stated ZYLKA is due to work on Monday, 01/18/99, at 0645 hours. She did not have any information as to where ZYLKA would be at this time.

01/17/99 @ 2056 Hrs.: I along with a CASO officer attempted contact at [REDACTED] CTH H, Chilton, a second time. There were no lights on. There were no vehicles in the yard. There did not appear to be anyone home.

A 10-28 of the vehicle was left with the instructions for the CASO officer. He stated he was done at 2200 hours; however, he would pass it on to the next shift coming on duty. Contact will be made with MTSO if ZYLKA shows up at her residence sometime before midnight.

01/18/99 @ 1200 Hrs.: Contact was made by phone with CASO Dispatch. I requested any notes that were left behind reference follow-up with ZYLKA. There were no notes, and the dispatcher was unaware of any. The information was forwarded to him. I requested an officer swing by her place of employment or residence to make contact and get a name as to where the vehicle is being kept.

01/18/99 @ 1530 Hrs.: Officer Pagels from CASO was assigned to make contact with ZYLKA as he knew her and the vehicle. He called me in my squad, requesting how much follow-up had been attempted. The attempt to make contact times were forwarded to him. He was informed contact, as of this time, has not been made. The phone conversation with her employer earlier in the day showed that ZYLKA was at work and would be completed around 1500 hours. Officer Pagels agreed to make contact and question as to where the vehicle is.

01/18/99 @ 1900 Hrs.: Upon arrival to the Shift Commander's Office, I received a phone call from WOSO officers. They were called by Officer Pagels with a name and address of an individual where ZYLKA'S vehicle is parked in Wood Co. The WOSO officers were out at this time with the vehicle and personally called stating there was extensive damage to the front, right front fender, continuing past the right front wheel into the side door on the passenger side of the vehicle. The officers stated the vehicle apparently struck something solid such as a bridge abutment, leaving severe tearing damage in the middle. There was no damage to the grill or hood area of the vehicle. Also, the people in Wood Co. stated ZYLKA'S vehicle had been there since October 1998 and that the engine had been blown. WOSO officers advised the vehicle had been stored in an old barn and was covered with dust.

This would not be the vehicle we are looking for. MJBushman

/bjc

S99 No 00492 | 631011 | 141027

WANTAWOC COUNTY SHERIFF
INCIDENT CARD

4. INCIDENT
08 / 599-00242

5. INCIDENT LOCATION
[REDACTED] Newton Rd.

6. NAME - LAST - FIRST - MI
Anonymous

7. D.O.B.

8. ADDRESS

9. TX-HOME

11. CITY STATE ZIP

10. TX-BUSINESS

12. DETAILS
See Attached.

18. ASSIGNED
MJSO [REDACTED] 929
Seim 1487

19. REC. BY
935

20. DIS. BY

21. HOW REC'D.
1. 911
2. POLICE RADIO
3. PHONE
4. TTY
5. IN PERSON
6. ON VIEW
7. OFF. OFF DUTY
8. C.B. RADIO
9. OTHER

22. TYPE OF REPORT
1. INCIDENT
2. ACCIDENT
3. CITATION
4. NONE

23. STATUS
1. UNFOUNDED
2. PNL
3. OTHER
4. CLEARED
5. EXCEPT CLEARED

24. DATE CLEARED
10/21/99

25. OFFENSE TYPE
1. ADULT NA
2. JUVENILE
3. UNKNOWN

14. REC'D	15. DISP	16. 10-23	17. 10-24
13. DAY			
SUN 1	THU 5		
MON 2	FRI 6		
TUE 3	SAT 7		
WED 4			

39. (CODE S-SUSPECT W-WITNESS V-VICTIM O-OTHER)					42. ADDRESS	43. TELEPHONE
CODE	40. NAME-LAST	FIRST	MI	41. D.O.B.		
O	DEHNE	SHAWN	C	[REDACTED]	[REDACTED] Newton Rd. Newton	[REDACTED]

01/17/99 @ 1845 Hrs.: I, Sgt. Seim, arrived at the SHAWN DEHNE residence to examine his pickup truck. I examined the pickup truck which was a GMC, not a Chevy. There was no front end damage on the pickup truck, and it was parked in the driveway.

The inquiry was done at the request of an anonymous party who called Crime Stoppers, indicating he had not seen DEHNE'S vehicle around for a while and thought it might be the suspect vehicle.

After assuring that this was not the vehicle in question, I left the area.
JSeim /bjc

45. IF COMPLAINANT DIFFERENT THEN CALLER, ENTER NAME, ADDRESS, D.O.B., TELEPHONE.

46. IF CODE O (OTHER) IS USED IN FIELD #39, EXPLAIN.

INCIDENT REPORT: NOTE: IF SECTION 22 ABOVE HAS NUMBER 4 CHECKED, DO NOT GO BEYOND THIS LINE WITHOUT RECORDS SECTION BEING ADVISED, OR NO RECORD ENTRIES WILL BE MADE BELOW THIS LINE.

PROPERTY VALUE	26. PROPERTY	A. CURRENCY	B. JEWELRY	C. FURS CLOTHING	D. VEHICLE (LOCAL)	E. OFFICE EQUIPMENT	F. RADIO, TV CAMERAS	G. FIREARMS	H. HOUSE-HOLD GOODS
	STOLEN	\$	\$	\$	\$	\$	\$	\$	\$
	RECOVERED	\$	\$	\$	\$	\$	\$	\$	\$
	26. PROPERTY	I. CONSUM-ABLES	J. LIVESTOCK	K. DRUGS	L. MARINE ITEMS	M. CONSTRUCTION ITEMS	N. LAWN AND GARDEN	O. SPORTING GOODS	P. MISC BICYCLE
	STOLEN	\$	\$	\$	\$	\$	\$	\$	\$
	RECOVERED	\$	\$	\$	\$	\$	\$	\$	\$

27. PROPERTY RECOVERED: LOCALLY _____ OTHER JURISDICTION _____ (INSERT O OR L)

PROPERTY ITEMIZATION	PROPERTY STOLEN/RECOVERED ITEMIZATION, USE THE FOLLOWING FORMAT				
	28. QUANTITY	29. ARTICLE NAME	30. BRAND NAME	31. SERIAL NUMBER	32. CODE
					S R <input type="checkbox"/> <input type="checkbox"/>
					S R <input type="checkbox"/> <input type="checkbox"/>
					S R <input type="checkbox"/> <input type="checkbox"/>
					S R <input type="checkbox"/> <input type="checkbox"/>
					S R <input type="checkbox"/> <input type="checkbox"/>

33. PROPERTY DAMAGE AMOUNT \$ _____ 34. INSURANCE COMPANY _____

35. OFFICER ASSAULTED Y N 36. ARSON Y N 37. STRUCTURE CODE _____ 38. DAMAGE \$ _____

47. CIB	ENTERED <input type="checkbox"/>	CANCELLED <input type="checkbox"/>	48. TOTAL AMOUNT PROPERTY STOLEN \$ _____
NCIC	<input type="checkbox"/>	<input type="checkbox"/>	
OTHER BROADCAST	<input type="checkbox"/>	<input type="checkbox"/>	
			49. TOTAL AMOUNT PROPERTY RECOVERED \$ _____

50. IS REPORT CONTINUED? YES NO 51. CAUTION INDICATORS, ATLS ETC.

52. DATA PROCESS INFORMATION:

COMPUTER ENTERED DATE 01/21/99

MICROFILM INDEXED INITIAL AS

IS CASE CLASSIFICATION CORRECT? N

IF N HAS CORRECTION BEEN MADE? N

53. FILE APPROVAL

BY QR DATE 01/21/99

S99 No 00495 10.31.11, 10.11.3.0

4. INCIDENT CS / S99-00492

5. INCIDENT LOCATION Wallander Rd.

6. NAME - LAST - FIRST - MI Anoniy (3) 7. D.O.B.

8. ADDRESS 9. TX-HOME

11. CITY STATE ZIP 10. TX-BUSINESS

12. DETAILS Rpts. A SHAWN ZUCCHI (20378)

OWNS A TWO-TONE BLU LATE

80'S SUBURBAN. HAS IN THE

PAST DRAWK TOO MUCH & HIT

19 29

WANTAWOC COUNTY SHERIFF INCIDENT CARD

18. ASSIGNED MJD Bushman 9/29 11/11

19. REC. BY 938 20. DIS. BY

21. HOW REC'D. 1. 911 2. POLICE RADIO 3. PHONE 4. TTY 5. IN PERSON 6. ON VIEW 7. OFF. OFF DUTY 8. C.B. RADIO 9. OTHER

22. TYPE OF REPORT: 1. INCIDENT 2. ACCIDENT 3. CITATION 4. NONE

23. STATUS 1. UNFOUNDED 2. PNL 3. OTHER 4. CLEARED 5. EXCEPT CLEARED

24. DATE CLEARED 10/18/99

25. OFFENSE TYPE 1. ADULT 2. JUVENILE 3. UNKNOWN

14. REC'D. 15. DISP. 16. 10-23 17. 10-24 13. DAY (SUN) 1 THU 5 MON 2 FRI 6 TUE 3 SAT 7 WED 4

39. (CODE S-SUSPECT W-WITNESS V-VICTIM O-OTHER)

Table with 4 columns: CODE, 40. NAME-LAST FIRST MI, 41. D.O.B., 42. ADDRESS, 43. TELEPHONE

3142

01-17-99 con't... many things. After these times he would store the TK in a barn that is on his property and make repairs. Caller has no knowledge of any current damage. Party is willing to speak with officer, see attached. 938/KB

01/17/99 Contact made with Shawn Zucchi at his residence Wallander Rd. Cato. After I, Lt. Bushman stated my business he lead me to a barn and showed the 87 Chev Suburban. It was dusty and piled in on the hay loft floor. Registration was expired, there was no damage to the front consistant with what I was looking for. This is not the suspect vehicl M.J. Bushman

45. IF COMPLAINANT DIFFERENT THEN CALLER, ENTER NAME, ADDRESS, D.O.B., TELEPHONE.

46. IF CODE O (OTHER) IS USED IN FIELD #39, EXPLAIN.

INCIDENT REPORT:

NOTE: IF SECTION 22 ABOVE HAS NUMBER 4 CHECKED, DO NOT GO BEYOND THIS LINE WITHOUT RECORDS SECTION BEING ADVISED, OR NO RECORD ENTRIES WILL BE MADE BELOW THIS LINE.

PROPERTY VALUE	26. PROPERTY	A. CURRENCY	B. JEWELRY	C. FURS CLOTHING	D. VEHICLE (LOCAL)	E. OFFICE EQUIPMENT	F. RADIO, TV CAMERAS	G. FIREARMS	H. HOUSE-HOLD GOODS
	STOLEN	\$	\$	\$	\$	\$	\$	\$	\$
	RECOVERED	\$	\$	\$	\$	\$	\$	\$	\$
	26. PROPERTY	I. CONSUMABLES	J. LIVESTOCK	K. DRUGS	L. MARINE ITEMS	M. CONSTRUCTION ITEMS	N. LAWN AND GARDEN	O. SPORTING GOODS	P. MISC BICYCLE
	STOLEN	\$	\$	\$	\$	\$	\$	\$	\$
	RECOVERED	\$	\$	\$	\$	\$	\$	\$	\$

27. PROPERTY RECOVERED: LOCALLY _____ OTHER JURISDICTION _____ (INSERT O OR L)

PROPERTY ITEMIZATION	PROPERTY STOLEN/RECOVERED ITEMIZATION, USE THE FOLLOWING FORMAT				
	28. QUANTITY	29. ARTICLE NAME	30. BRAND NAME	31. SERIAL NUMBER	32. CODE
					S R <input type="checkbox"/> <input type="checkbox"/>
					S R <input type="checkbox"/> <input type="checkbox"/>
					S R <input type="checkbox"/> <input type="checkbox"/>
					S R <input type="checkbox"/> <input type="checkbox"/>
					S R <input type="checkbox"/> <input type="checkbox"/>

33. PROPERTY DAMAGE AMOUNT \$ _____

34. INSURANCE COMPANY _____

35. OFFICER ASSAULTED Y N

36. ARSON Y N

37. STRUCTURE CODE _____

38. DAMAGE \$ _____

47. CIB ENTERED CANCELLED
 NCIC
 OTHER BROADCAST

48. TOTAL AMOUNT PROPERTY STOLEN \$ _____

49. TOTAL AMOUNT PROPERTY RECOVERED \$ _____

50. IS REPORT CONTINUED? YES NO

51. CAUTION INDICATORS, ATLS ETC.

52. DATA PROCESS INFORMATION:

COMPUTER ENTERED DATE 01/18/99

MICROFILM INDEXED INITIAL KS

IS CASE CLASSIFICATION CORRECT? Y N
 IF N HAS CORRECTION BEEN MADE? Y N

53. FILE APPROVAL

BY 

DATE 01/18/99

S99 N^o 00534 163011 52000

4. INCIDENT CS/599-0242

5. INCIDENT LOCATION 535th/Meadow Ln

6. NAME--LAST-FIRST-MI ANON (2) 7. D.O.B.

8. ADDRESS 9. TX-HOME

11. CITY STATE ZIP 10. TX-BUSINESS

12. DETAILS States he saw a early 80's chevrolet truck (green) parked on NW corner above loc. in front end @ side grill damage.

14. REC'D.	15. DISP	16. 10-23	17. 10-24
13. DAY			
SUN 1	THU 5		
MON 2	FRI 6		
TUE 3	SAT 7		
WED 4			

INCIDENT CARD

18. ASSIGNED MTSO 9129
MTPD 9135
BUSHMAN H/H

19. REC. BY 945 NM 20. DIS. BY

21. HOW REC'D.
1. 911
2. POLICE RADIO
3. PHONE
4. TTY
5. IN PERSON
6. ON VIEW
7. OFF. OFF DUTY
8. C.B. RADIO
9. OTHER

22. TYPE OF REPORT
1. INCIDENT
2. ACCIDENT
3. CITATION
4. NONE

23. STATUS
1. UNFOUNDED
2. PNL
3. OTHER
4. CLEARED
5. EXCEPT CLEARED

24. DATE CLEARED 01/21/99

25. OFFENSE TYPE
1. ADULT NA
2. JUVENILE
3. UNKNOWN

21A. M.O.

39. (CODE S-SUSPECT W-WITNESS V-VICTIM O-OTHER)

CODE	40. NAME-LAST	FIRST	MI	41. D.O.B.	42. ADDRESS	43. TELEPHONE

01/18/98 2200hrs I, Lt. Bushman took a look at the vehicle. Its tires are too large, damage minimal, vehicle raised too high, not the suspect vehicle M.J. Bushman
BJ 95556 Tk 99

45. IF COMPLAINANT DIFFERENT THEN CALLER, ENTER NAME, ADDRESS, D.O.B., TELEPHONE.

46. IF CODE O (OTHER) IS USED IN FIELD #39, EXPLAIN.

INCIDENT REPORT: NOTE: IF SECTION 22 ABOVE HAS NUMBER 4 CHECKED, DO NOT GO BEYOND THIS LINE WITHOUT RECORDS SECTION BEING ADVISED, OR NO RECORD ENTRIES WILL BE MADE BELOW THIS LINE.

PROPERTY VALUE	26. PROPERTY	A. CURRENCY	B. JEWELRY	C. FURS CLOTHING	D. VEHICLE (LOCAL)	E. OFFICE EQUIPMENT	F. RADIO, TV CAMERAS	G. FIREARMS	H. HOUSE-HOLD GOODS
	STOLEN	\$	\$	\$	\$	\$	\$	\$	\$
	RECOVERED	\$	\$	\$	\$	\$	\$	\$	\$
	26. PROPERTY	I. CONSUMABLES	J. LIVESTOCK	K. DRUGS	L. MARINE ITEMS	M. CONSTRUCTION ITEMS	N. LAWN AND GARDEN	O. SPORTING GOODS	P. MISC BICYCLE
	STOLEN	\$	\$	\$	\$	\$	\$	\$	\$
	RECOVERED	\$	\$	\$	\$	\$	\$	\$	\$

27. PROPERTY RECOVERED: LOCALLY _____ OTHER JURISDICTION _____ (INSERT O OR L)

PROPERTY ITEMIZATION	PROPERTY STOLEN/RECOVERED ITEMIZATION, USE THE FOLLOWING FORMAT				
	28. QUANTITY	29. ARTICLE NAME	30. BRAND NAME	31. SERIAL NUMBER	32. CODE
					S R <input type="checkbox"/> <input type="checkbox"/>
					S R <input type="checkbox"/> <input type="checkbox"/>
					S R <input type="checkbox"/> <input type="checkbox"/>
					S R <input type="checkbox"/> <input type="checkbox"/>
					S R <input type="checkbox"/> <input type="checkbox"/>

33. PROPERTY DAMAGE AMOUNT \$ _____ 34. INSURANCE COMPANY _____

35. OFFICER ASSAULTED Y N 36. ARSON Y N 37. STRUCTURE CODE _____ 38. DAMAGE \$ _____

47. CIB	ENTERED <input type="checkbox"/>	CANCELLED <input type="checkbox"/>	48. TOTAL AMOUNT PROPERTY STOLEN \$ _____
NCIC	<input type="checkbox"/>	<input type="checkbox"/>	
OTHER BROADCAST	<input type="checkbox"/>	<input type="checkbox"/>	
			49. TOTAL AMOUNT PROPERTY RECOVERED \$ _____

50. IS REPORT CONTINUED? YES NO 51. CAUTION INDICATORS, ATLS ETC.

52. DATA PROCESS INFORMATION:

COMPUTER ENTERED DATE 01/21/99

MICROFILM INDEXED INITIAL RS

IS CASE CLASSIFICATION CORRECT? IF N HAS CORRECTION BEEN MADE? Y N

53. FILE APPROVAL BY AK DATE 01/21/99

S99 N# 00550 10.310.11 11.4101.2

4. INCIDENT
CS/599 - 00242

5. INCIDENT LOCATION
Hwy CR / SILVER CK RD

6. NAME - LAST - FIRST - MI
ANON. (2)

7. D.O.B.

8. ADDRESS

9. TX-HOME

11. CITY STATE ZIP

10. TX-BUSINESS

12. DETAILS
CABER STATES THOMAS E.
LEONOWICZ (65987) HAS 2 CHEV.
TRUCKS & LIVES AT [REDACTED] CTH CR
"HE MIGHT HAVE DONE IT"

INCIDENT CARD

18. ASSIGNED
MISO 9129
JOST

19. REC. BY
945

20. DIS. BY

22. TYPE OF REPORT
1. INCIDENT
2. ACCIDENT
3. CITATION
4. NONE

21. HOW REC'D.
1. 911
2. POLICE RADIO
3. PHONE CS
4. TTY
5. IN PERSON
6. ON VIEW
7. OFF. OFF DUTY
8. C.B. RADIO
9. OTHER

23. STATUS
1. UNFOUNDED
2. PNL
3. OTHER
4. CLEARED
5. EXCEPT CLEARED

24. DATE CLEARED
031099

25. OFFENSE TYPE
1. ADULT NA
2. JUVENILE
3. UNKNOWN

14. REC'D	15. DISP	16. 10-23	17. 10-24
13. DAY			
SUN 1	THU 5		
MON 2	FRI 6		
TUE 3	SAT 7		
WED 4			

39. (CODE S-SUSPECT W-WITNESS V-VICTIM O-OTHER)

CODE	40. NAME-LAST	FIRST	MI	41. D.O.B.	42. ADDRESS	43. TELEPHONE

On 01-21-99 I, Deputy Jost, made contact at the above location with Thomas's parents. They advised Thomas was at work with the older of his two trucks. I observed the 1997 Chev trk. in the drive-way red in color no damage and wrong year/body style. The parents advised a third shift officer stopped in on the Sunday after the accident and looked at both of Thomas's vehicle. *Jost* MJ

00000 TN 680

45. IF COMPLAINANT DIFFERENT THEN CALLER, ENTER NAME, ADDRESS, D.O.B., TELEPHONE.

46. IF CODE O (OTHER) IS USED IN FIELD #39, EXPLAIN.

INCIDENT REPORT: NOTE: IF SECTION 22 ABOVE HAS NUMBER 4 CHECKED, DO NOT GO BEYOND THIS LINE WITHOUT RECORDS SECTION BEING ADVISED, OR NO RECORD ENTRIES WILL BE MADE BELOW THIS LINE.

PROPERTY VALUE	26. PROPERTY	A. CURRENCY	B. JEWELRY	C. FURS CLOTHING	D. VEHICLE (LOCAL)	E. OFFICE EQUIPMENT	F. RADIO, TV CAMERAS	G. FIREARMS	H. HOUSE HOLD GOOI
	STOLEN	\$	\$	\$	\$	\$	\$	\$	\$
	RECOVERED	\$	\$	\$	\$	\$	\$	\$	\$
	26. PROPERTY	I. CONSUM- ABLES	J. LIVESTOCK	K. DRUGS	L. MARINE ITEMS	M. CONSTRU- TION ITEMS	N. LAWN AND GARDEN	O. SPORTING GOODS	P. MISC BICYCLE
	STOLEN	\$	\$	\$	\$	\$	\$	\$	\$
	RECOVERED	\$	\$	\$	\$	\$	\$	\$	\$

27. PROPERTY RECOVERED: LOCALLY _____ OTHER JURISDICTION _____ (INSERT O OR L)

PROPERTY ITEMIZATION	PROPERTY STOLEN/RECOVERED ITEMIZATION, USE THE FOLLOWING FORMAT				
	28. QUANTITY	29. ARTICLE NAME	30. BRAND NAME	31. SERIAL NUMBER	32. CODE
					S R <input type="checkbox"/> <input type="checkbox"/>
					S R <input type="checkbox"/> <input type="checkbox"/>
					S R <input type="checkbox"/> <input type="checkbox"/>
					S R <input type="checkbox"/> <input type="checkbox"/>
					S R <input type="checkbox"/> <input type="checkbox"/>

33. PROPERTY DAMAGE AMOUNT \$ _____

34. INSURANCE COMPANY _____

35. OFFICER ASSAULTED Y N 36. ARSON Y N 37. STRUCTURE CODE _____ 38. DAMAGE \$ _____

47. CIB ENTERED CANCELLED
 NCIC
 OTHER BROADCAST

48. TOTAL AMOUNT PROPERTY STOLEN \$ _____

49. TOTAL AMOUNT PROPERTY RECOVERED \$ _____

50. IS REPORT CONTINUED? YES NO

51. CAUTION INDICATORS, ATLS ETC.

52. DATA PROCESS INFORMATION:

COMPUTER ENTERED DATE 3.8.99

MICROFILM INDEXED INITIAL KS

IS CASE CLASSIFICATION CORRECT? N
 IF N HAS CORRECTION BEEN MADE? N

53. FILE APPROVAL

BY [Signature] DATE 3.8.99

S99 No 00557 030.1, 52000

4. INCIDENT
CS/S99-00242

5. INCIDENT LOCATION
Hwy C.R 9 Saw Cr Rd

6. NAME- LAST-FIRST-MI
ANON. (2)

7. D.O.B.

8. ADDRESS

9. TX-HOME

11. CITY STATE ZIP

10. TX-BUSINESS

12. DETAILS
 Caller states there is a
 guy who drives that Hwy
 whose parents live in Shst.
 Name Chris K. KLUNCK (141790)
 has Chev truck. (DRINKS)

14. REC'D	15. DISP	16. 10-23	17. 10-24
13. DAY			
SUN 1	THU 5		
MON 2	FRI 6		
TUE 3	SAT 7		
WED 4			

INCIDENT CARD

18. ASSIGNED
MTSO 929
LENK 2019

19. REC. BY

20. DIS. BY

22. TYPE OF REPORT
 1. INCIDENT
 2. ACCIDENT
 3. CITATION
 4. NONE

21. HOW REC'D.
 1. 911
 2. POLICE RADIO
 3. PHONE
 4. TTY
 5. IN PERSON
 6. ON VIEW
 7. OFF. OFF DUTY
 8. C.B. RADIO
 9. OTHER C.S.

23. STATUS
 1. UNFOUNDED
 2. PNL
 3. OTHER
 4. CLEARED
 5. EXCEPT CLEARED

24. DATE CLEARED 030899

25. OFFENSE TYPE
 1. ADULT NA
 2. JUVENILE
 3. UNKNOWN

21A. M.O.

39. (CODE S-SUSPECT W-WITNESS V-VICTIM O-OTHER)

CODE	40. NAME-LAST	FIRST	MI	41. D.O.B.	42. ADDRESS	43. TELEPHONE

Parents live at [redacted] thst and Calumet dr-sheboygan.

See pages 49 and 64-65 (addition by Det. Sgt. Lenk) of S99-00242.

No vehicles registered under KLUNCK. JMLenk /bjc

1000 IN 666

45. IF COMPLAINANT DIFFERENT THEN CALLER, ENTER NAME, ADDRESS, D.O.B., TELEPHONE.

46. IF CODE "O (OTHER) IS USED IN FIELD #39, EXPLAIN.

INCIDENT REPORT: NOTE: IF SECTION 22 ABOVE HAS NUMBER 4 CHECKED, DO NOT GO BEYOND THIS LINE WITHOUT RECORDS SECTION BEING ADVISED, OR NO RECORD ENTRIES WILL BE MADE BELOW THIS LINE.

PROPERTY VALUE	26. PROPERTY	A. CURRENCY	B. JEWELRY	C. FURS CLOTHING	D. VEHICLE (LOCAL)	E. OFFICE EQUIPMENT	F. RADIO, TV CAMERAS	G. FIREARMS	H. HOUSE-HOLD GOOD
	STOLEN	\$	\$	\$	\$	\$	\$	\$	\$
	RECOVERED	\$	\$	\$	\$	\$	\$	\$	\$
	26. PROPERTY	I. CONSUMABLES	J. LIVESTOCK	K. DRUGS	L. MARINE ITEMS	M. CONSTRUCTION ITEMS	N. LAWN AND GARDEN	O. SPORTING GOODS	P. MISC BICYCLE
	STOLEN	\$	\$	\$	\$	\$	\$	\$	\$
	RECOVERED	\$	\$	\$	\$	\$	\$	\$	\$

27. PROPERTY RECOVERED: LOCALLY ____ OTHER JURISDICTION ____ (INSERT O OR L)

PROPERTY ITEMIZATION	PROPERTY STOLEN/RECOVERED ITEMIZATION, USE THE FOLLOWING FORMAT				
	28. QUANTITY	29. ARTICLE NAME	30. BRAND NAME	31. SERIAL NUMBER	
					S R <input type="checkbox"/> <input type="checkbox"/>
					S R <input type="checkbox"/> <input type="checkbox"/>
					S R <input type="checkbox"/> <input type="checkbox"/>
					S R <input type="checkbox"/> <input type="checkbox"/>

33. PROPERTY DAMAGE AMOUNT \$ _____

34. INSURANCE COMPANY _____

35. OFFICER ASSAULTED Y N

36. ARSON Y N

37. STRUCTURE CODE _____

38. DAMAGE \$ _____

47. CIB ENTERED CANCELLED
 NCIC
 OTHER BROADCAST

48. TOTAL AMOUNT PROPERTY STOLEN \$ _____

49. TOTAL AMOUNT PROPERTY RECOVERED \$ _____

50. IS REPORT CONTINUED? YES NO

51. CAUTION INDICATORS, ATLS ETC.

52. DATA PROCESS INFORMATION:

COMPUTER ENTERED DATE 3.8.99
 MICROFILM INDEXED INITIAL JS

53. FILE APPROVAL

IS CASE CLASSIFICATION CORRECT? N
 IF N HAS CORRECTION BEEN MADE? Y N

BY [Signature] DATE 3.8.99

S99 No 00558 16,310,11 11,410,0,4

INCIDENT CARD

4. INCIDENT
CS/S99-00242

5. INCIDENT LOCATION
CTH CR.

6. NAME - LAST - FIRST - MI
ANONYMOUS

7. D.O.B.

8. ADDRESS

9. TX-HOME

10. TX-BUSINESS

11. CITY STATE ZIP

12. DETAILS
CALLER SAW BLACK FULL SIZE BLAZER,
WI RP TBD-861 AT LAKESIDE DIST.
CTR ON S 30TH ST ON FRIDAY 1-15-99.
BLAZER HAD A BLACK BRA OVER GRILL

18. ASSIGNED
MTSO 91219
Bushman 491

19. REC BY 932 20. DIS. BY 932

21. HOW REC'D.
1. 911
2. POLICE RADIO
3. PHONE
4. TTY
5. IN PERSON
6. ON VIEW
7. OFF. OFF DUTY
8. C.B. RADIO
9. OTHER

22. TYPE OF REPORT
1. INCIDENT
2. ACCIDENT
3. CITATION
4. NONE

23. STATUS
1. UNFOUNDED
2. PNL
3. OTHER
4. CLEARED
5. EXCEPT CLEARED

24. DATE CLEARED 10/12/99

25. OFFENSE TYPE
1. ADULT NA
2. JUVENILE
3. UNKNOWN

21A. M.O.

14. REC'D	15. DISP	16. 10-23	17. 10-24
13. DAY			
SUN 1	THU 5		
MON 2	FRI 6		
TUE 3	SAT 7		
WED 4			

39. (CODE S-SUSPECT W-WITNESS V-VICTIM O-OTHER)				42. ADDRESS	43. TELEPHONE
CODE	40. NAME-LAST	FIRST	MI	41. D.O.B.	

but caller advised seeing a black or empty spot on the passenger side of the grill showing through the bra. Caller advised the owner may be Andy Duellmann, but 10-28 shows it registered to Tina Hecker. 932/mh 01/18/99 I, Lt. Bushman located this suspected vehicle standing in the driveway at [redacted] N. Union Rd, Mtwc. It was the same vehicle parked at Marv's service center on CTH CR the night of the incident. Vehicle is not a suspect vehicle, tires too large, built up to high and there is no damage consistent with what we are looking for in the suspect vehicle. M.J. [signature]

45. IF COMPLAINANT DIFFERENT THEN CALLER, ENTER NAME, ADDRESS, D.O.B., TELEPHONE.

46. IF CODE O (OTHER) IS USED IN FIELD #39, EXPLAIN.

INCIDENT REPORT: NOTE: IF SECTION 22 ABOVE HAS NUMBER 4 CHECKED, DO NOT GO BEYOND THIS LINE WITHOUT RECORDS SECTION BEING ADVISED, OR NO RECORD ENTRIES WILL BE MADE BELOW THIS LINE.

PROPERTY VALUE	26. PROPERTY	A. CURRENCY	B. JEWELRY	C. FURS CLOTHING	D. VEHICLE (LOCAL)	E. OFFICE EQUIPMENT	F. RADIO, TV CAMERAS	G. FIREARMS	H. HOUSE-HOLD GOODS
	STOLEN	\$	\$	\$	\$	\$	\$	\$	\$
	RECOVERED	\$	\$	\$	\$	\$	\$	\$	\$
	26. PROPERTY	I. CONSUMABLES	J. LIVESTOCK	K. DRUGS	L. MARINE ITEMS	M. CONSTRUCTION ITEMS	N. LAWN AND GARDEN	O. SPORTING GOODS	P. MISC BICYCLE
STOLEN	\$	\$	\$	\$	\$	\$	\$	\$	
RECOVERED	\$	\$	\$	\$	\$	\$	\$	\$	

27. PROPERTY RECOVERED: LOCALLY _____ OTHER JURISDICTION _____ (INSERT O OR L)

PROPERTY ITEMIZATION	PROPERTY STOLEN/RECOVERED ITEMIZATION, USE THE FOLLOWING FORMAT				32. CODE
	28. QUANTITY	29. ARTICLE NAME	30. BRAND NAME	31. SERIAL NUMBER	
					S R <input type="checkbox"/> <input type="checkbox"/>
					S R <input type="checkbox"/> <input type="checkbox"/>
					S R <input type="checkbox"/> <input type="checkbox"/>
					S R <input type="checkbox"/> <input type="checkbox"/>
					S R <input type="checkbox"/> <input type="checkbox"/>
					S R <input type="checkbox"/> <input type="checkbox"/>

33. PROPERTY DAMAGE AMOUNT \$ _____ 34. INSURANCE COMPANY _____

35. OFFICER ASSAULTED Y N 36. ARSON Y N 37. STRUCTURE CODE _____ 38. DAMAGE \$ _____

47. CIB	ENTERED <input type="checkbox"/>	CANCELLED <input type="checkbox"/>	48. TOTAL AMOUNT PROPERTY STOLEN \$ _____
NCIC	<input type="checkbox"/>	<input type="checkbox"/>	
OTHER BROADCAST	<input type="checkbox"/>	<input type="checkbox"/>	
			49. TOTAL AMOUNT PROPERTY RECOVERED \$ _____

50. IS REPORT CONTINUED? YES NO 51. CAUTION INDICATORS, ATLS ETC.

52. DATA PROCESS INFORMATION:

COMPUTER ENTERED DATE 01/21/99

MICROFILM INDEXED INITIAL KS

IS CASE CLASSIFICATION CORRECT? IF N HAS CORRECTION BEEN MADE? Y N

53. FILE APPROVAL BY [Signature] DATE 01/21/99

MCSO 028 1/91

Mike

This veh. is a blk full
size Blazer. It was parked
on S. 9TH ST S. of Lincoln
H.S. Had front end damage
to ^{front left} bumper and R. headlight
area. The grill was covered
but what I could see of
it it looked intact. Before
I could get a picture I
got a 10-33 call and
could not get back to
it.

Pete

S99 IN U0011 1631011 104017

4. INCIDENT
CS/See 599-00242

5. INCIDENT LOCATION
Hwy

6. NAME - LAST - FIRST - MI 7. D.O.B.
CASO (205)

8. ADDRESS 9. TX-HOME

11. CITY STATE ZIP 10. TX-BUSINESS

12. DETAILS
CASO ADVISED OFFCR. ID'D
2-TONE GREY, DK BLU CHEV SUBURBAN
W/ GRILL DAMAGE, REGISTERED TO
CISLER, SUSAN K. (123904) See below.

14. REC'D	15. DISP	16. 10-23	17. 10-24
13. DAY			
SUN 1	THU 5		
MON 2	FRI 6		
TUE 3	SAT 7		
WED 4			

INCIDENT CARD

18. ASSIGNED
MTSO 9129
Petersen 11415

19. REC. BY 20. DIS. BY
930 930

21. HOW REC'D.
1. 911
2. POLICE RADIO
3. PHONE
4. TTY
5. IN PERSON
6. ON VIEW
7. OFF. OFF DUTY
8. C.B. RADIO
9. OTHER

22. TYPE OF REPORT
1. INCIDENT
2. ACCIDENT
3. CITATION
4. NONE

23. STATUS
1. UNFOUNDED
2. PNL
3. OTHER
4. CLEARED
5. EXCEPT CLEARED

24. DATE CLEARED 10/21/99

25. OFFENSE TYPE
1. ADULT NA
2. JUVENILE
3. UNKNOWN

21A. M.O.

39. (CODE S-SUSPECT W-WITNESS V-VICTIM O-OTHER)

CODE	40. NAME-LAST	FIRST	MI	41. D.O.B.	42. ADDRESS	43. TELEPHONE

01/20/99 (Cont.) CASO advised this subject will be stopping at MTSO to have someone take a look at this vehicle. DB/930 DB

01/20/99 Ken Petersen advised Dispatch he did check this vehicle, at 1444 hrs.; this would not be suspect vehicle. (See attached TTY and 10-28) DB/930 DB

45. IF COMPLAINANT DIFFERENT THEN CALLER, ENTER NAME, ADDRESS, D.O.B., TELEPHONE.

46. IF CODE O (OTHER) IS USED IN FIELD #39, EXPLAIN.

INCIDENT REPORT: NOTE: IF SECTION 22 ABOVE HAS NUMBER 4 CHECKED, DO NOT GO BEYOND THIS LINE WITHOUT RECORDS SECTION BEING ADVISED, OR NO RECORD ENTRIES WILL BE MADE BELOW THIS LINE.

PROPERTY VALUE	26. PROPERTY	A. CURRENCY	B. JEWELRY	C. FURS CLOTHING	D. VEHICLE (LOCAL)	E. OFFICE EQUIPMENT	F. RADIO, TV CAMERAS	G. FIREARMS	H. HOUSE-HOLD GOODS
	STOLEN	\$	\$	\$	\$	\$	\$	\$	\$
	RECOVERED	\$	\$	\$	\$	\$	\$	\$	\$
	26. PROPERTY	I. CONSUMABLES	J. LIVESTOCK	K. DRUGS	L. MARINE ITEMS	M. CONSTRUCTION ITEMS	N. LAWN AND GARDEN	O. SPORTING GOODS	P. MISC BICYCLE
	STOLEN	\$	\$	\$	\$	\$	\$	\$	\$
	RECOVERED	\$	\$	\$	\$	\$	\$	\$	\$

27. PROPERTY RECOVERED: LOCALLY ____ OTHER JURISDICTION ____ (INSERT O OR L)

PROPERTY ITEMIZATION	PROPERTY STOLEN/RECOVERED ITEMIZATION, USE THE FOLLOWING FORMAT				31. SERIAL NUMBER	32. CODE		
	28. QUANTITY	29. ARTICLE NAME	30. BRAND NAME			S	R	
							<input type="checkbox"/>	<input type="checkbox"/>
							<input type="checkbox"/>	<input type="checkbox"/>
							<input type="checkbox"/>	<input type="checkbox"/>
							<input type="checkbox"/>	<input type="checkbox"/>

33. PROPERTY DAMAGE AMOUNT \$ _____

34. INSURANCE COMPANY _____

35. OFFICER ASSAULTED Y N

36. ARSON Y N

37. STRUCTURE CODE _____ 38. DAMAGE \$ _____

47. CIB ENTERED CANCELLED
 NCIC
 OTHER BROADCAST

48. TOTAL AMOUNT PROPERTY STOLEN \$ _____

49. TOTAL AMOUNT PROPERTY RECOVERED \$ _____

50. IS REPORT CONTINUED? YES NO

51. CAUTION INDICATORS, ATLS ETC.

52. DATA PROCESS INFORMATION:

COMPUTER ENTERED DATE 10/21/99
 MICROFILM INDEXED INITIAL KS

53. FILE APPROVAL

IS CASE CLASSIFICATION CORRECT? Y N
 IF N HAS CORRECTION BEEN MADE? Y N

BY _____ DATE

S99 IN 00010 16310.11 160100.0

INCIDENT CARD

4. INCIDENT CS/599-00242

5. INCIDENT LOCATION

6. NAME - LAST - FIRST - MI ANONYMOUS (2) 7. D.O.B.

8. ADDRESS 9. TX-HOME

11. CITY STATE ZIP 10. TX-BUSINESS

12. DETAILS States a Jim Peters on CR had a Blue Blazer last year, doesn't know if he sold it or not.

18. ASSIGNED MTSU 91249

19. REC. BY 945 20. DIS. BY

22. TYPE OF REPORT
 INCIDENT
 ACCIDENT
 CITATION
 NONE

21. HOW REC'D.
 1. 911
 2. POLICE RADIO
 3. PHONE
 4. TTY
 5. IN PERSON
 6. ON VIEW
 7. OFF. OFF DUTY
 8. C.B. RADIO
 OTHER CS

23. STATUS
 1. UNFOUNDED
 2. PNL
 OTHER
 4. CLEARED
 5. EXCEPT CLEARED

24. DATE CLEARED 03/03/99

25. OFFENSE TYPE
 1. ADULT NA
 2. JUVENILE
 3. UNKNOWN

14. REC'D	15. DISP	16. 10-23	17. 10-24
13. DAY			
SUN 1	THU 5		
MON 2	FRI 6		
TUE 3	SAT 7		
<u>WED 4</u>			

39. (CODE S-SUSPECT W-WITNESS V-VICTIM O-OTHER)				41. D.O.B.		42. ADDRESS		43. TELEPHONE
CODE	40. NAME-LAST	FIRST	MI					

RHAS check run. no vehicles that match.

45. IF COMPLAINANT DIFFERENT THEN CALLER, ENTER NAME, ADDRESS, D.O.B., TELEPHONE.

46. IF CODE O (OTHER) IS USED IN FIELD #39, EXPLAIN.

INCIDENT REPORT: NOTE: IF SECTION 22 ABOVE HAS NUMBER 4 CHECKED, DO NOT GO BEYOND THIS LINE WITHOUT RECORDS SECTION BEING ADVISED, OR NO RECORD ENTRIES WILL BE MADE BELOW THIS LINE.

PROPERTY VALUE	26. PROPERTY	A. CURRENCY	B. JEWELRY	C. FURS CLOTHING	D. VEHICLE (LOCAL)	E. OFFICE EQUIPMENT	F. RADIO, TV CAMERAS	G. FIREARMS	H. HOUSE-HOLD GOODS
	STOLEN	\$	\$	\$	\$	\$	\$	\$	\$
	RECOVERED	\$	\$	\$	\$	\$	\$	\$	\$
	26. PROPERTY	I. CONSUM-ABLES	J. LIVESTOCK	K. DRUGS	L. MARINE ITEMS	M. CONSTRUCTION ITEMS	N. LAWN AND GARDEN	O. SPORTING GOODS	P. MISC BICYCLE
	STOLEN	\$	\$	\$	\$	\$	\$	\$	\$
	RECOVERED	\$	\$	\$	\$	\$	\$	\$	\$

27. PROPERTY RECOVERED: LOCALLY ____ OTHER JURISDICTION ____ (INSERT O OR L)

PROPERTY ITEMIZATION	PROPERTY STOLEN/RECOVERED ITEMIZATION, USE THE FOLLOWING FORMAT				
	28. QUANTITY	29. ARTICLE NAME	30. BRAND NAME	31. SERIAL NUMBER	32. CODE
					S R <input type="checkbox"/> <input type="checkbox"/>
					S R <input type="checkbox"/> <input type="checkbox"/>
					S R <input type="checkbox"/> <input type="checkbox"/>
					S R <input type="checkbox"/> <input type="checkbox"/>

33. PROPERTY DAMAGE AMOUNT \$ _____

34. INSURANCE COMPANY _____

35. OFFICER ASSAULTED Y N

36. ARSON Y N

37. STRUCTURE CODE _____ 38. DAMAGE \$ _____

47. CIB ENTERED CANCELLED
 NCIC
 OTHER BROADCAST

48. TOTAL AMOUNT PROPERTY STOLEN \$ _____

49. TOTAL AMOUNT PROPERTY RECOVERED \$ _____

50. IS REPORT CONTINUED? YES NO

51. CAUTION INDICATORS, ATLS ETC.

52. DATA PROCESS INFORMATION:

COMPUTER ENTERED DATE 3.8.99

MICROFILM INDEXED INITIAL KS

IS CASE CLASSIFICATION CORRECT? Y N
 IF N HAS CORRECTION BEEN MADE? Y N

53. FILE APPROVAL

BY [Signature] DATE 3.8.99

S99 IN 00010 1031011 152000

INCIDENT CARD

4. INCIDENT: CS/599-00242

5. INCIDENT LOCATION

6. NAME - LAST, FIRST, MI [REDACTED] 7. D.O.B. [REDACTED]

8. ADDRESS [REDACTED] 9. TX-HOME [REDACTED]

11. CITY: MANITOWOC, WI STATE: WI ZIP: 54220 10. TX-BUSINESS

12. DETAILS: STATES THEY JUST OBSERVED AN OLDER CHEV VAN, NO GRILL, BENT ON HOOD & CRACKED WINDSHIELD, ALLOW (R) SIDE, AT BANK.

18. ASSIGNED: MTSO 929

19. REC. BY: 945 20. DIS. BY:

21. HOW REC'D. 1. 911 2. POLICE RADIO 3. PHONE 4. TTY 5. IN PERSON 6. ON VIEW 7. OFF. OFF DUTY 8. C.B. RADIO 9. OTHER/CS 21A. M.O.

22. TYPE OF REPORT 1. INCIDENT 2. ACCIDENT 3. CITATION 4. NONE

23. STATUS 1. UNFOUNDED 2. PNL 3. OTHER 4. CLEARED 5. EXCEPT CLEARED

24. DATE CLEARED: 03/08/99

25. OFFENSE TYPE 1. ADULT NA 2. JUVENILE 3. UNKNOWN

14. REC'D	15. DISP	16. 10-23	17. 10-24
13. DAY			
SUN 1	THU 5		
MON 2	FRI 6		
TUE 3	SAT 7		
WED 4			

39. (CODE S-SUSPECT W-WITNESS V-VICTIM O-OTHER)

CODE	40. NAME-LAST	FIRST	MI	41. D.O.B.	42. ADDRESS	43. TELEPHONE

Caller is [REDACTED] an employee of the bank. Also gave plate # of XC1509.

DOES NOT MATCH VEHICLE, M.D.

JUVENILE INFO REDACTED

45. IF COMPLAINANT DIFFERENT THEN CALLER, ENTER NAME, ADDRESS, D.O.B., TELEPHONE.

46. IF CODE O (OTHER) IS USED IN FIELD #39, EXPLAIN.

INCIDENT REPORT: NOTE: IF SECTION 22 ABOVE HAS NUMBER 4 CHECKED, DO NOT GO BEYOND THIS LINE WITHOUT RECORDS SECTION BEING ADVISED, OR NO RECORD ENTRIES WILL BE MADE BELOW THIS LINE.

PROPERTY VALUE	26. PROPERTY	A. CURRENCY	B. JEWELRY	C. FURS CLOTHING	D. VEHICLE (LOCAL)	E. OFFICE EQUIPMENT	F. RADIO, TV CAMERAS	G. FIREARMS	H. HOUSE-HOLD GOODS
	STOLEN	\$	\$	\$	\$	\$	\$	\$	\$
	RECOVERED	\$	\$	\$	\$	\$	\$	\$	\$
	26. PROPERTY	I. CONSUMABLES	J. LIVESTOCK	K. DRUGS	L. MARINE ITEMS	M. CONSTRUCTION ITEMS	N. LAWN AND GARDEN	O. SPORTING GOODS	P. MISC BICYCLE
	STOLEN	\$	\$	\$	\$	\$	\$	\$	\$
	RECOVERED	\$	\$	\$	\$	\$	\$	\$	\$

27. PROPERTY RECOVERED: LOCALLY _____ OTHER JURISDICTION _____ (INSERT O OR L)

PROPERTY ITEMIZATION	PROPERTY STOLEN/RECOVERED ITEMIZATION, USE THE FOLLOWING FORMAT				
	28. QUANTITY	29. ARTICLE NAME	30. BRAND NAME	31. SERIAL NUMBER	32. CODE
					S <input type="checkbox"/> R <input type="checkbox"/>
					S <input type="checkbox"/> R <input type="checkbox"/>
					S <input type="checkbox"/> R <input type="checkbox"/>
					S <input type="checkbox"/> R <input type="checkbox"/>

33. PROPERTY DAMAGE AMOUNT \$ _____ 34. INSURANCE COMPANY _____

35. OFFICER ASSAULTED Y N - 36. ARSON Y N 37. STRUCTURE CODE _____ 38. DAMAGE \$ _____

47. CIB	ENTERED <input type="checkbox"/>	CANCELLED <input type="checkbox"/>	48. TOTAL AMOUNT PROPERTY STOLEN \$ _____
NCIC	<input type="checkbox"/>	<input type="checkbox"/>	
OTHER BROADCAST	<input type="checkbox"/>	<input type="checkbox"/>	
			49. TOTAL AMOUNT PROPERTY RECOVERED \$ _____

50. IS REPORT CONTINUED? YES NO 51. CAUTION INDICATORS, ATLS ETC.

52. DATA PROCESS INFORMATION:
 COMPUTER ENTERED DATE 3/7/99
 MICROFILM INDEXED INITIAL AS
 IS CASE CLASSIFICATION CORRECT? Y N
 IF N HAS CORRECTION BEEN MADE? Y N

53. FILE APPROVAL
 BY [Signature] DATE 03/08/99

4. INCIDENT **CS 599-00242**

5. INCIDENT LOCATION

6. NAME- LAST- FIRST- MI **Terry Ernest Used Cars** 7. D.O.B.

8. ADDRESS **56472** 9. TX-HOME

11. CITY STATE ZIP 10. TX-BUSINESS

12. DETAILS
Rec'd call from [redacted] states they have '86 trk - grey w/ grill damage

18. ASSIGNED **OHEARN** **4510**
921

19. REC BY **921** 20. DIS. BY

21. HOW REC'D
 1. 911
 2. POLICE RADIO
 3. PHONE
 4. TTY
 5. IN PERSON
 6. ON VIEW
 7. OFF. OFF DUTY
 8. C.B. RADIO
 9. OTHER
 21A. M.O.

22. TYPE OF REPORT
 1. INCIDENT
 2. ACCIDENT
 3. CITATION
 4. NONE

23. STATUS
 1. UNFOUNDED
 2. PNL
 3. OTHER
 4. CLEARED
 5. EXCEPT CLEARED

24. DATE CLEARED **03/09/99**

25. OFFENSE TYPE
 1. ADULT NA
 2. JUVENILE
 3. UNKNOWN

14. REC'D	15. DISP	16. 10-23	17. 10-24
13. DAY			
SUN 1	THU 5		
MON 2	FRI 6		
TUE 3	SAT 7		
WED 4			

39. (CODE S-SUSPECT W-WITNESS V-VICTIM O-OTHER)					41. D.O.B.	42. ADDRESS	43. TELEPHONE
CODE	40. NAME-LAST	FIRST	MI				
0	Lowery	Timothy	J	[redacted]	[redacted]	S 23rd. #1100 Mtwc. 54220	

01-20-99 @ 0809 Lt. recd. call from dispatch concerning crimestopper tip. A vehicle had been brought into Ernst Auto Company of TR. by either Peitroske or First Chrysler Plym. The vehicle was a 86 Custom/Delux Chev. Trk. it had damage to the driver side of grill. I viewed the vehicle and saw that a piece of the Grill portion of the drivers side, approx. 8 inches in length was missing from the grill, there was no other damage to this front of the vehicle. A VIN check indicated that Mr. Lowery was the owner and a check of his residence produced no one home. Officer will check on next day on to obtain info on damage. At this point this damage is not as extensive as the damage from our suspect vehicle and can be ruled out as a suspect vehicle. TKO *TKO*

01/21/99 @ 0600 hrs. Met W/ Timothy Lowery he stated that the vehicle he owned had the part damaged when he bought it. He stated he traded the vehicle in to Pietroski's that way. Again a check of the vehicle indicated that the damage was not relevant to the evidence we have obtained and this can be closed. TKO *TKO*

REC'D IN 1000

45. IF COMPLAINANT DIFFERENT THEN CALLER, ENTER NAME, ADDRESS, D.O.B., TELEPHONE.

46. IF CODE O (OTHER) IS USED IN FIELD #39, EXPLAIN.

INCIDENT REPORT:

NOTE: IF SECTION 22 ABOVE HAS NUMBER 4 CHECKED, DO NOT GO BEYOND THIS LINE WITHOUT RECORDS SECTION BEING ADVISED, OR NO RECORD ENTRIES WILL BE MADE BELOW THIS LINE.

PROPERTY VALUE	26. PROPERTY	A. CURRENCY	B. JEWELRY	C. FURS CLOTHING	D. VEHICLE (LOCAL)	E. OFFICE EQUIPMENT	F. RADIO, TV CAMERAS	G. FIREARMS	H. HOUSE-HOLD GOODS
	STOLEN	\$	\$	\$	\$	\$	\$	\$	\$
	RECOVERED	\$	\$	\$	\$	\$	\$	\$	\$
	26. PROPERTY	I. CONSUM-ABLES	J. LIVESTOCK	K. DRUGS	L. MARINE ITEMS	M. CONSTRUCTION ITEMS	N. LAWN AND GARDEN	O. SPORTING GOODS	P. MISC BICYCLE
	STOLEN	\$	\$	\$	\$	\$	\$	\$	\$
	RECOVERED	\$	\$	\$	\$	\$	\$	\$	\$

27. PROPERTY RECOVERED: LOCALLY _____ OTHER JURISDICTION _____ (INSERT O OR L)

PROPERTY ITEMIZATION	PROPERTY STOLEN/RECOVERED ITEMIZATION, USE THE FOLLOWING FORMAT				
	28. QUANTITY	29. ARTICLE NAME	30. BRAND NAME	31. SERIAL NUMBER	32. CODE
					S R <input type="checkbox"/> <input type="checkbox"/>
					S R <input type="checkbox"/> <input type="checkbox"/>
					S R <input type="checkbox"/> <input type="checkbox"/>
					S R <input type="checkbox"/> <input type="checkbox"/>
					S R <input type="checkbox"/> <input type="checkbox"/>

33. PROPERTY DAMAGE AMOUNT \$ _____

34. INSURANCE COMPANY _____

35. OFFICER ASSAULTED Y N

36. ARSON Y N

37. STRUCTURE CODE _____ 38. DAMAGE \$ _____

	ENTERED	CANCELLED
47. CIB	<input type="checkbox"/>	<input type="checkbox"/>
NCIC	<input type="checkbox"/>	<input type="checkbox"/>
OTHER BROADCAST	<input type="checkbox"/>	<input type="checkbox"/>

48. TOTAL AMOUNT PROPERTY STOLEN \$ _____

49. TOTAL AMOUNT PROPERTY RECOVERED \$ _____

50. IS REPORT CONTINUED? YES NO

51. CAUTION INDICATORS, ATLS ETC.

52. DATA PROCESS INFORMATION:

COMPUTER ENTERED DATE 3.8.99
 MICROFILM INDEXED INITIAL KS

53. FILE APPROVAL

IS CASE CLASSIFICATION CORRECT? Y N
 IF N HAS CORRECTION BEEN MADE? Y N

BY [Signature] DATE 03.08.99

S99 No 00580 1030.11 110000

INCIDENT CARD

4. INCIDENT CS- S99-00242

5. INCIDENT LOCATION Monroe Ave. G.B.

6. NAME - LAST - FIRST - MI Anon. 7. D.O.B.

8. ADDRESS 9. TX-HOME

11. CITY STATE ZIP 10 TX-BUSINESS

12. DETAILS
Chevy Truck MI plates
XK6497 Tan color
Missing grill parts

14. REC'D	15. DISP	16. 10-23	17. 10-24
13. DAY			
SUN 1	THU 5		
MON 2	FRI 6		
<input checked="" type="checkbox"/> WED 3	SAT 7		
WED 4			

18. ASSIGNED 929

19. REC. BY 944 20. DIS. BY

21. HOW REC'D.
1. 911
2. POLICE RADIO
3. PHONE
4. TTY
5. IN PERSON
6. ON VIEW
7. OFF. OFF DUTY
8. C.B. RADIO
9. OTHER

22. TYPE OF REPORT
1. INCIDENT
2. ACCIDENT
3. CITATION
4. NONE

23. STATUS
1. UNFOUNDED
2. PNL
3. OTHER
4. CLEARED
5. EXCEPT CLEARED

24. DATE CLEARED 123 0899

25. OFFENSE TYPE
1. ADULT NA
2. JUVENILE
3. UNKNOWN

39. (CODE S-SUSPECT W-WITNESS V-VICTIM O-OTHER)

CODE	40. NAME-LAST	FIRST	MI	41. D.O.B.	42. ADDRESS	43. TELEPHONE

does not match.

45. IF COMPLAINANT DIFFERENT THEN CALLER, ENTER NAME, ADDRESS, D.O.B., TELEPHONE.

46. IF CODE O (OTHER) IS USED IN FIELD #39, EXPLAIN.

INCIDENT REPORT: NOTE: IF SECTION 22 ABOVE HAS NUMBER 4 CHECKED, DO NOT GO BEYOND THIS LINE WITHOUT RECORDS SECTION BEING ADVISED, OR NO RECORD ENTRIES WILL BE MADE BELOW THIS LINE.

PROPERTY VALUE	26. PROPERTY	A. CURRENCY	B. JEWELRY	C. FURS CLOTHING	D. VEHICLE (LOCAL)	E. OFFICE EQUIPMENT	F. RADIO, TV CAMERAS	G. FIREARMS	H. HOUSE-HOLD GOODS
	STOLEN	\$	\$	\$	\$	\$	\$	\$	\$
	RECOVERED	\$	\$	\$	\$	\$	\$	\$	\$
	26. PROPERTY	I. CONSUMABLES	J. LIVESTOCK	K. DRUGS	L. MARINE ITEMS	M. CONSTRUCTION ITEMS	N. LAWN AND GARDEN	O. SPORTING GOODS	P. MISC BICYCLE
STOLEN	\$	\$	\$	\$	\$	\$	\$	\$	
RECOVERED	\$	\$	\$	\$	\$	\$	\$	\$	

27. PROPERTY RECOVERED: LOCALLY _____ OTHER JURISDICTION _____ (INSERT O OR L)

PROPERTY ITEMIZATION	PROPERTY STOLEN/RECOVERED ITEMIZATION, USE THE FOLLOWING FORMAT				
	28. QUANTITY	29. ARTICLE NAME	30. BRAND NAME	31. SERIAL NUMBER	32. CODE
					S R <input type="checkbox"/> <input type="checkbox"/>
					S R <input type="checkbox"/> <input type="checkbox"/>
					S R <input type="checkbox"/> <input type="checkbox"/>
					S R <input type="checkbox"/> <input type="checkbox"/>

33. PROPERTY DAMAGE AMOUNT \$ _____

34. INSURANCE COMPANY _____

35. OFFICER ASSAULTED Y N

36. ARSON Y N

37. STRUCTURE CODE _____

38. DAMAGE \$ _____

	ENTERED	CANCELLED
47. CIB	<input type="checkbox"/>	<input type="checkbox"/>
NCIC	<input type="checkbox"/>	<input type="checkbox"/>
OTHER BROADCAST	<input type="checkbox"/>	<input type="checkbox"/>

48. TOTAL AMOUNT PROPERTY STOLEN \$ _____

49. TOTAL AMOUNT PROPERTY RECOVERED \$ _____

50. IS REPORT CONTINUED? YES NO

51. CAUTION INDICATORS, ATLS ETC.

52. DATA PROCESS INFORMATION:

COMPUTER ENTERED DATE 3.8.99
 MICROFILM INDEXED INITIAL KS

53. FILE APPROVAL

IS CASE CLASSIFICATION CORRECT? Y N
 IF N HAS CORRECTION BEEN MADE? Y N

BY [Signature] DATE 030899

S99 IN: 00570 1630.11 11310.4

INCIDENT CARD

4. INCIDENT CS- S99-00242

18. ASSIGNED MISO, 929
Bushman H.H.1

5. INCIDENT LOCATION

6. NAME- LAST-FIRST-MI [REDACTED] 7. D.O.B. [REDACTED]

8. ADDRESS [REDACTED] 9. TX-HOME [REDACTED]

11. CITY [REDACTED] STATE [REDACTED] ZIP [REDACTED] 10. TX-BUSINESS [REDACTED]

12. DETAILS
Whit GMC Late 80s Sierra P/u
has damage to front bumper
also has piece missing from
grill plate BK77-417

19. REC. BY 944 20. DIS. BY 944
22. TYPE OF REPORT
1. INCIDENT
2. ACCIDENT
3. CITATION
4. NONE

21. HOW REC'D.
1. 911
2. POLICE RADIO
3. PHONE
4. TTY
5. IN PERSON
6. ON VIEW
7. OFF. OFF DUTY
8. C.B. RADIO
9. OTHER

23. STATUS
1. UNFOUNDED
2. PNL
3. OTHER
4. CLEARED
5. EXCEPT CLEARED
24. DATE CLEARED 10/21/99
25. OFFENSE TYPE
1. ADULT NA
2. JUVENILE
3. UNKNOWN

14. REC'D	15. DISP	16. 10-23	17. 10-24
13. DAY			
SUN 1	THU 5		
MON 2	FRI 6		
<u>TUE 3</u>	SAT 7		
WED 4			

39. (CODE S-SUSPECT W-WITNESS V-VICTIM O-OTHER)				41. D.O.B.		42. ADDRESS		43. TELEPHONE	
CODE	40. NAME-LAST	FIRST	MI						

01-20-99 The LP# came back on 1996 GMC TK, this does not match the suspect vehicle.
MJ Bushman

45. IF COMPLAINANT DIFFERENT THEN CALLER, ENTER NAME, ADDRESS, D.O.B., TELEPHONE.

46. IF CODE O (OTHER) IS USED IN FIELD #39, EXPLAIN.

INCIDENT REPORT: NOTE: IF SECTION 22 ABOVE HAS NUMBER 4 CHECKED, DO NOT GO BEYOND THIS LINE WITHOUT RECORDS SECTION BEING ADVISED, OR NO RECORD ENTRIES WILL BE MADE BELOW THIS LINE.

PROPERTY VALUE	26. PROPERTY	A. CURRENCY	B. JEWELRY	C. FURS CLOTHING	D. VEHICLE (LOCAL)	E. OFFICE EQUIPMENT	F. RADIO, TV CAMERAS	G. FIREARMS	H. HOUSE-HOLD GOODS
	STOLEN	\$	\$	\$	\$	\$	\$	\$	\$
	RECOVERED	\$	\$	\$	\$	\$	\$	\$	\$
	26. PROPERTY	I. CONSUMABLES	J. LIVESTOCK	K. DRUGS	L. MARINE ITEMS	M. CONSTRUCTION ITEMS	N. LAWN AND GARDEN	O. SPORTING GOODS	P. MISC BICYCLE
	STOLEN	\$	\$	\$	\$	\$	\$	\$	\$
	RECOVERED	\$	\$	\$	\$	\$	\$	\$	\$

27. PROPERTY RECOVERED: LOCALLY _____ OTHER JURISDICTION _____ (INSERT O OR L)

PROPERTY ITEMIZATION	PROPERTY STOLEN/RECOVERED ITEMIZATION, USE THE FOLLOWING FORMAT				
	28. QUANTITY	29. ARTICLE NAME	30. BRAND NAME	31. SERIAL NUMBER	32. CODE
					S R <input type="checkbox"/> <input type="checkbox"/>
					S R <input type="checkbox"/> <input type="checkbox"/>
					S R <input type="checkbox"/> <input type="checkbox"/>
					S R <input type="checkbox"/> <input type="checkbox"/>

33. PROPERTY DAMAGE AMOUNT \$ _____ 34. INSURANCE COMPANY _____

35. OFFICER ASSAULTED Y N 36. ARSON Y N 37. STRUCTURE CODE _____ 38. DAMAGE \$ _____

47. CIB	ENTERED <input type="checkbox"/>	CANCELLED <input type="checkbox"/>	48. TOTAL AMOUNT PROPERTY STOLEN \$ _____
NCIC	<input type="checkbox"/>	<input type="checkbox"/>	
OTHER BROADCAST	<input type="checkbox"/>	<input type="checkbox"/>	
			49. TOTAL AMOUNT PROPERTY RECOVERED \$ _____

50. IS REPORT CONTINUED? YES NO 51. CAUTION INDICATORS, ATLS ETC.

52. DATA PROCESS INFORMATION:

COMPUTER ENTERED DATE 01/21/99

MICROFILM INDEXED INITIAL KS

IS CASE CLASSIFICATION CORRECT? Y N

IF N HAS CORRECTION BEEN MADE? Y N

53. FILE APPROVAL

BY [Signature] DATE 01/21/99

S99 IN U0010 163011 160000

INCIDENT CARD

4. INCIDENT CS / See 599-00242

5. INCIDENT LOCATION

6. NAME - LAST - FIRST - MI ANONYMOUS (2) 7. D.O.B.

8. ADDRESS 9. TX-HOME

11. CITY STATE ZIP 10. TX-BUSINESS

12. DETAILS
COMPL. STATES DAN FORKINS DRIVES HIS GIRLFRIEND'S, MICHELLE RABE'S, TRK. (NO DESCRIPTION) WHICH IS REGISTERED UNDER HER NAME
 (See below)

18. ASSIGNED
MTSO 9219
M. Bushman 4411

19. REC. BY 930 20. DIS. BY 930
 22. TYPE OF REPORT
 INCIDENT
 ACCIDENT
 CITATION
 NONE

21. HOW REC'D.
 1. 911
 2. POLICE RADIO
 3. PHONE CS
 4. TTY
 5. IN PERSON
 6. ON VIEW
 7. OFF. OFF DUTY
 8. C.B. RADIO
 9. OTHER
 21A. M.O.

14. REC'D 15. DISP 16. 10-23 17. 10-24
 13. DAY
 SUN 1 THU 5
 MON 2 FRI 6
 TUE 3 SAT 7
 WED 4

23. STATUS
 1. UNFOUNDED
 2. PNL
 3. OTHER
 4. CLEARED
 5. EXCEPT CLEARED
 24. DATE CLEARED 01/25/99
 25. OFFENSE TYPE
 1. ADULT NA
 2. JUVENILE
 3. UNKNOWN

39. (CODE S-SUSPECT W-WITNESS V-VICTIM O-OTHER)	40. NAME-LAST	FIRST	MI	41. D.O.B.	42. ADDRESS	43. TELEPHONE
O	RABE <u>8496</u>	MICHELLE	M		Pigeon Lake Rd, Valders	
O	FORKINS <u>2506</u>	DANIEL	T		Pigeon Lake Rd, Valders	

(Cont'd) . Caller states FORKINS travels CTH CR, and he has a drinking problem. She had no further information, other than Michelle Rabe (sp) lives near Pigeon River. DB/930 DB

01/21/99 @ 1915 Hrs.: I, Lt. M. Bushman, made contact with MICHELLE RABE at her residence at Pigeon Lake Rd, Valders. Prior to me getting out of the squad, RABE came from the house and stood on the east deck. She was questioned about her 1988 Chevrolet truck. She stated the vehicle was not there at this time. She advised she did own the vehicle; however, it was at DJ'S TRANSMISSIONS in Sheboygan for transmission repair. The vehicle is a red and black Blazer. It was taken in for service on 01/11/99.

RABE was asked if there was any damage to the front of the vehicle. She looked away from me at this time as her boyfriend, DANIEL FORKINS, was coming out onto the porch. She was distracted from my question. She told FORKINS to go back in the house as she would handle this. FORKINS appeared to be under the influence of alcohol, and it appeared as if he was on the verge to come out and discuss the matter with me. RABE again told him to go back inside, she would handle it. RABE was questioned a second time if there would be any damage to the front of the vehicle. She did not immediately respond and looked in the direction of FORKINS, giving him a stern stare. After the third question of whether there would be damage on the vehicle, RABE finally stated she did not think there was any damage to the front of it. She and FORKINS delivered the 4-wheel drive Blazer to the garage and at that time, she stated there was no damage on it. I got the distinct impression RABE was being evasive and possibly knew more than what she was telling us.

RABE then invited me inside as she wanted to consult a calendar as to the exact date she took the Blazer to Sheboygan--that being 01/11/99. At this point and time, FORKINS began badgering me with questions; and he was abruptly cut off by RABE. FORKINS was asked about his 1983 Chevrolet Blazer which he owned and was involved in with an accident on 05/18/96. He stated the vehicle was junked after the accident as it was not driveable and too expensive to repair.

As I was escorted to the door, I requested RABE to step outside one more time. I

45. IF COMPLAINANT DIFFERENT THEN CALLER, ENTER NAME, ADDRESS, D.O.B., TELEPHONE.

46. IF CODE O (OTHER) IS USED IN FIELD #39, EXPLAIN.

INCIDENT REPORT: NOTE: IF SECTION 22 ABOVE HAS NUMBER 4 CHECKED, DO NOT GO BEYOND THIS LINE WITHOUT RECORDS SECTION BEING ADVISED, OR NO RECORD ENTRIES WILL BE MADE BELOW THIS LINE.

PROPERTY VALUE	26. PROPERTY	A. CURRENCY	B. JEWELRY	C. FURS CLOTHING	D. VEHICLE (LOCAL)	E. OFFICE EQUIPMENT	F. RADIO, TV CAMERAS	G. FIREARMS	H. HOUSE-HOLD GOODS
	STOLEN	\$	\$	\$	\$	\$	\$	\$	\$
	RECOVERED	\$	\$	\$	\$	\$	\$	\$	\$
	26. PROPERTY	I. CONSUMABLES	J. LIVESTOCK	K. DRUGS	L. MARINE ITEMS	M. CONSTRUCTION ITEMS	N. LAWN AND GARDEN	O. SPORTING GOODS	P. MISC BICYCLE
	STOLEN	\$	\$	\$	\$	\$	\$	\$	\$
	RECOVERED	\$	\$	\$	\$	\$	\$	\$	\$

27. PROPERTY RECOVERED: LOCALLY _____ OTHER JURISDICTION _____ (INSERT O OR L)

PROPERTY ITEMIZATION	PROPERTY STOLEN/RECOVERED ITEMIZATION, USE THE FOLLOWING FORMAT				
	28. QUANTITY	29. ARTICLE NAME	30. BRAND NAME	31. SERIAL NUMBER	32. CODE
					S R <input type="checkbox"/> <input type="checkbox"/>
					S R <input type="checkbox"/> <input type="checkbox"/>
					S R <input type="checkbox"/> <input type="checkbox"/>
					S R <input type="checkbox"/> <input type="checkbox"/>

33. PROPERTY DAMAGE AMOUNT \$ _____

34. INSURANCE COMPANY _____

35. OFFICER ASSAULTED Y N 36. ARSON Y N 37. STRUCTURE CODE _____ 38. DAMAGE \$ _____

47. CIB ENTERED CANCELLED
 NCIC
 OTHER BROADCAST

48. TOTAL AMOUNT PROPERTY STOLEN \$ _____

49. TOTAL AMOUNT PROPERTY RECOVERED \$ _____

50. IS REPORT CONTINUED? YES NO

51. CAUTION INDICATORS, ATLS ETC.

52. DATA PROCESS INFORMATION:

COMPUTER ENTERED DATE 01/29/99
 MICROFILM INDEXED INITIAL AS

53. FILE APPROVAL

IS CASE CLASSIFICATION CORRECT?
 IF N HAS CORRECTION BEEN MADE? Y N

BY [Signature] DATE 01/25/99

MANITOWOC COUNTY SHERIFF'S DEPARTMENT
FOLLOW-UP REPORT

Page: 2

CASE NUMBER: 599-00618 CLASSIFICATION: _____

INCIDENT: _____

DATE AND TIME: _____

REPORT CONTINUED:

questioned her a fourth time, whether or not I would find damage on her vehicle. She then began to cry at which time FORKINS again came out on the deck. Eventually, she escorted me to my squad and told me that she was in the process of getting a Restraining Order and having FORKINS removed from her residence. She inquired about this today and obtained paperwork; however, she did not complete the paperwork, stating the reason for her wanting him off the property is because of his drinking and continued problems.

01/21/99 @ 2100 Hrs.: I, Lt. Bushman, made contact with the Shift Commander for SBPD. A request was made for an officer to swing by DJ'S TRANSMISSIONS to check on the RABE vehicle which should be in for service.

Within 15 minutes, a return call was made. The red and black S10 Blazer is definitely at DJ'S TRANSMISSION with the transmission in numerous pieces on the floor. This vehicle does not match the description of the suspect vehicle we are looking for.

RABE was also questioned as to any other vehicles that FORKINS may have access to. None of them matched the description close to the hit and run accident. MJBushman /bjc

Wisconsin Motor Vehicle Accident Report

Please Do Not Write In This Microfilm Space

INSTRUCTIONS Please use a -Black Ink Pen or #2 Pencil. Mark Areas as shown: Correct Mark Incorrect Marks Reportable Accident <input checked="" type="checkbox"/> N	County 36 MUN/TWP 37	Accident Date MONTH DAY YEAR 18 96	Time of Accident (Military Time) HOUR MIN. 2014	Total Number UNITS INJURED KILLED 03 02 00	Hit & Run <input type="checkbox"/> Y Government Property <input type="checkbox"/> Y Fire (Narrative) <input type="checkbox"/> Y Photos Taken (Narrative) <input checked="" type="checkbox"/> N Trailer or Towed (Narrative) <input type="checkbox"/> Y Truck or Bus (Last Page) <input type="checkbox"/> N Load Spillage <input type="checkbox"/> Y Construction Zone <input type="checkbox"/> Y Names Exchanged <input type="checkbox"/> Y	Sheet No. Of 12
	ACCIDENT LOCATION <input checked="" type="checkbox"/> Public Highway, Intersection/Related <input type="checkbox"/> Public Highway, Non-Intersection <input type="checkbox"/> Parking Lot <input type="checkbox"/> Private Property or Road					

LATITUDE (GPS) Degrees: _____ Minutes: _____ Seconds: _____ LONGITUDE (GPS) Degrees: _____ Minutes: _____ Seconds: _____

ON Hwy No. and / Street Name **CTH C / E. MAIN** Estimated _____ FT. _____ MI. FROM HWY No. and / Street Name **16 CTH A / N 4TH AVE**

House # _____ Fire # _____ Other _____ Utility # _____ Railroad # _____ Agency Space _____ Special Study _____

Unit Number	Unit Type	Total Number of Occupants	Direction of Travel (Before the Accident)	Unit Number	Unit Type	Total Number of Occupants	Direction of Travel (Before the Accident)
2 3 4	2 3 4	0 1 3 4 5 6	W E	1 3 4	J 3 4	0 2 3 4 5 6	N E
5 6 7 8	5 6 7	Other	S	5 6 7 8	5 6 7	Other	S
9 10				9 10			

OPERATOR Last Name VETTER First EVELYN M.I. H158 R ADDRESS CRYSTAL DR APT 3 City & State VALDERS WI 54245 Driver's License Number WI 99	OPERATOR Last Name FOCKINS First Daniel M.I. 2586 T ADDRESS N 27 ST City & State SHEBOYGAN WI 53081 Driver's License Number WI 97
--	--

On Duty Accident <input type="checkbox"/> P Police <input type="checkbox"/> E EMT-Paramedic <input type="checkbox"/> F Fire Fighter <input type="checkbox"/> H Winter Hwy Maintenance Sex <input checked="" type="checkbox"/> M <input type="checkbox"/> F Operating as Classified <input checked="" type="checkbox"/> CMV <input type="checkbox"/> Y <input type="checkbox"/> N	Class (Mark All That Apply) <input checked="" type="checkbox"/> A <input type="checkbox"/> B <input type="checkbox"/> C <input type="checkbox"/> M <input type="checkbox"/> N <input type="checkbox"/> P <input type="checkbox"/> S <input type="checkbox"/> T Endorse <input type="checkbox"/> H <input type="checkbox"/> P <input type="checkbox"/> T <input type="checkbox"/> N <input type="checkbox"/> S <input type="checkbox"/> F	On Duty Accident <input type="checkbox"/> P Police <input type="checkbox"/> E EMT-Paramedic <input type="checkbox"/> F Fire Fighter <input type="checkbox"/> H Winter Hwy Maintenance Sex <input type="checkbox"/> F <input checked="" type="checkbox"/> M Operating as Classified <input type="checkbox"/> A <input checked="" type="checkbox"/> B <input type="checkbox"/> C <input type="checkbox"/> M <input type="checkbox"/> N <input type="checkbox"/> P <input type="checkbox"/> S	Class (Mark Only One) <input checked="" type="checkbox"/> A <input type="checkbox"/> B <input type="checkbox"/> C Endor (Mark All That App) <input type="checkbox"/> H <input type="checkbox"/> P <input type="checkbox"/> T <input type="checkbox"/> N <input type="checkbox"/> S
--	---	--	---

Severity <input checked="" type="checkbox"/> K <input type="checkbox"/> A <input type="checkbox"/> B <input type="checkbox"/> C SEAT Position 1 SAFETY Equipment 1 AIRBAG <input checked="" type="checkbox"/> 1 Deployed <input type="checkbox"/> 2 Non Deployed <input type="checkbox"/> 3 Not Applicable <input type="checkbox"/> 4 Unknown EJECTED <input type="checkbox"/> 1 Not Applicable <input type="checkbox"/> 2 Not Ejected <input type="checkbox"/> 3 Totally Ejected <input type="checkbox"/> 4 Partially Ejected <input type="checkbox"/> 5 Unknown	Severity <input checked="" type="checkbox"/> K <input type="checkbox"/> A <input type="checkbox"/> B <input type="checkbox"/> C SEAT Position 1 SAFETY Equipment 1 AIRBAG <input checked="" type="checkbox"/> 1 Deployed <input type="checkbox"/> 2 Non Deployed <input type="checkbox"/> 3 Not Applicable <input type="checkbox"/> 4 Unknown EJECTED <input type="checkbox"/> 1 Not Applicable <input type="checkbox"/> 2 Not Ejected <input type="checkbox"/> 3 Totally Ejected <input type="checkbox"/> 4 Partially Ejected <input type="checkbox"/> 5 Unknown
--	--

TRAPPED/EXTRICATED <input checked="" type="checkbox"/> 1 Not Applicable <input type="checkbox"/> 2 Not Trapped <input type="checkbox"/> 3 Trapped/Extricated <input type="checkbox"/> 4 Trapped/Not Extricated <input type="checkbox"/> 5 Unknown Medical Transport <input checked="" type="checkbox"/> N	TRAPPED/EXTRICATED <input checked="" type="checkbox"/> 1 Not Applicable <input type="checkbox"/> 2 Not Trapped <input type="checkbox"/> 3 Trapped/Extricated <input type="checkbox"/> 4 Trapped/Not Extricated <input type="checkbox"/> 5 Unknown Medical Transport <input checked="" type="checkbox"/> N
--	--

Vehicle Owner Same <input checked="" type="checkbox"/> N Last Name First M.I. Street Address City & State ZIP Phone Number	Vehicle Owner Same <input checked="" type="checkbox"/> N Last Name First M.I. Street Address City & State ZIP Phone Number
---	---

Year of Vehicle 92 Make Buick Model CEN Body Style 4dr Color Sil	Year of Vehicle 83 Make CHEV Model BLZ Body Style TRK Color BIL
---	--

License Plate Number BCL218 Plate Type Aut State WI Exp. Year 97	License Plate Number AJ30564 Plate Type ATK State WI Exp. Year 91
--	---

Policy Holder's Name WISCONSIN AMERICAN Stat. # Liability Insurance Company	Policy Holder's Name GREAT WAY INSC. Stat. # Liability Insurance Company
---	--

Occupant Unit Number 6 NAME Last PETERSEN First mabel M.I. A ADDRESS US151 VALDERS WI City & State ZIP Address Same as Operator <input checked="" type="checkbox"/> Yes <input type="checkbox"/> No EJECTED <input type="checkbox"/> 1 Not Applicable <input type="checkbox"/> 2 Not Ejected <input type="checkbox"/> 3 Totally Ejected <input type="checkbox"/> 4 Partially Ejected <input type="checkbox"/> 5 Unknown TRAPPED/EXTRICATED <input type="checkbox"/> 1 Not Applicable <input type="checkbox"/> 2 Not Trapped <input type="checkbox"/> 3 Trapped/Extricated <input type="checkbox"/> 4 Trapped/Not Extricated <input type="checkbox"/> 5 Unknown Medical Transport <input checked="" type="checkbox"/> N	Severity <input checked="" type="checkbox"/> K <input type="checkbox"/> A <input type="checkbox"/> B <input type="checkbox"/> C SEAT Position 2 SAFETY Equipment 1 AIRBAG <input checked="" type="checkbox"/> 1 Deployed <input type="checkbox"/> 2 Non Deployed <input type="checkbox"/> 3 Not Applicable <input type="checkbox"/> 4 Unknown
--	---

Accident No. 04080
 Police No. 296
 Date

099 11- 00040 | 6,3|0|1 | , | 6, 0|0,00

4. INCIDENT CS/S99-00242		INCIDENT CARD	
5. INCIDENT LOCATION CTH CR		18. ASSIGNED O'Hearn 9/21/99	
6. NAME--LAST-FIRST-MI Anonymus 2		7. D.O.B.	
8. ADDRESS		9. TX-HOME	
11. CITY STATE ZIP		10. TX-BUSINESS	
12. DETAILS Request for report of crime stopper report.			
14. REC'D	15. DISP	16. 10-23	17. 10-24
13. DAY SUN 1 THU 5 MON 2 FRI 6 TUE 3 SAT 7 WED 4			
19. REC. BY 456		20. DIS. BY	
21. HOW REC'D. 1. 911 2. POLICE RADIO 3. PHONE 4. TTY 5. IN PERSON 6. ON VIEW 7. OFF. OFF DUTY 8. C.B. RADIO 9. OTHER		22. TYPE OF REPORT 1. INCIDENT 2. ACCIDENT 3. CITATION 4. NONE	
23. STATUS 1. UNFOUNDED 2. PNL 3. OTHER 4. CLEARED 5. EXCEPT CLEARED		24. DATE CLEARED 03/08/99	
25. OFFENSE TYPE 1. ADULT <input type="checkbox"/> NA <input checked="" type="checkbox"/> 2. JUVENILE <input type="checkbox"/> 3. UNKNOWN <input type="checkbox"/>		21A. M.O.	

39. (CODE S-SUSPECT W-WITNESS V-VICTIM O-OTHER)						
CODE	40. NAME-LAST	FIRST	MI	41. D.O.B.	42. ADDRESS	43. TELEPHONE
W	ANONYMOUS--					
O	ESCOBAR	153105	SERGIO	*NMI*	S 12th St, Manitowoc	
O	PRESTON	176128	THOMAS	G	Johnston Dr #29, Manitowoc	
O	VANSLUYS	176129	GEORGE		Smies Rd, Oostburg 53070	

01/20/99 @ 1120 Hrs.: I, Lt. O'Hearn, received a call from Sgt. Larry Zimney of MTPD who stated that he had very sketchy information, but he received information from an employee at the WEYERHAEUSER CORP. by the name of [REDACTED] at a phone number of [REDACTED]. He wishes to remain anonymous and not have his name used.

The information received by Sgt. Zimney stated that [REDACTED] sold a vehicle--a 1986 Chevy Celebrity 4-door, blue in color--to an individual only known to him as SERGIO. He stated [REDACTED] advised him the individual lives in Manitowoc in the [REDACTED] block of S 12th St, a house that is way in the back behind LLOYD'S PHOTO. He stated he drove his 1986 Celebrity over to SERGIO'S residence, met with him, and then was given a ride back to his residence by SERGIO in a Chevy truck which appeared to be a Suburban-type vehicle. He stated it was nighttime and he did not look at the dash or grill area; however, he stated it had a broken windshield. He stated this occurred on 01/10/99. [REDACTED] asked SERGIO what happened, and he stated he did not know due to the fact the truck he was driving he claimed belonged to his brother. He was unsure who the vehicle actually belonged to.

01/21/99 @ 0530 Hrs.: [REDACTED] was contacted and all this information was confirmed.

Approximately 10-15 minutes later, it should be noted I drove to the area of S 12th St where I located SERGIO ESCOBAR who resides at [REDACTED] S 12th St, Manitowoc.

SERGIO stated he was driving a red and bluish Chevy Suburban on the day he picked up [REDACTED]. He stated the vehicle was owned by a girl only known to him as CINDY. He stated the windshield is broken, but the grill seemed to be in good shape.

I advised SERGIO about his revoked DL status and stated that if he would obtain the name of the individual that owns the Chevy Suburban vehicle and then refrains from driving, at this point, nothing would take place reference him operating a motor vehicle. He stated he would contact his girlfriend who has the number of CINDY. He attempted to give me directions, that CINDY lives somewhere in one of the trailer parks on Johnston Dr. I then departed.

45. IF COMPLAINANT DIFFERENT THEN CALLER, ENTER NAME, ADDRESS, D.O.B., TELEPHONE.

46. IF CODE O (OTHER) IS USED IN FIELD #39, EXPLAIN.

INCIDENT REPORT: NOTE: IF SECTION 22 ABOVE HAS NUMBER 4 CHECKED, DO NOT GO BEYOND THIS LINE WITHOUT RECORDS SECTION BEING ADVISED, OR NO RECORD ENTRIES WILL BE MADE BELOW THIS LINE.

PROPERTY VALUE	26. PROPERTY	A. CURRENCY	B. JEWELRY	C. FURS CLOTHING	D. VEHICLE (LOCAL)	E. OFFICE EQUIPMENT	F. RADIO, TV CAMERAS	G. FIREARMS	H. HOUSEHOLD GOODS
	STOLEN	\$	\$	\$	\$	\$	\$	\$	\$
	RECOVERED	\$	\$	\$	\$	\$	\$	\$	\$
	26. PROPERTY	I. CONSUMABLES	J. LIVESTOCK	K. DRUGS	L. MARINE ITEMS	M. CONSTRUCTION ITEMS	N. LAWN AND GARDEN	O. SPORTING GOODS	P. MISC BICYCLE
	STOLEN	\$	\$	\$	\$	\$	\$	\$	\$
	RECOVERED	\$	\$	\$	\$	\$	\$	\$	\$

27. PROPERTY RECOVERED: LOCALLY OTHER JURISDICTION (INSERT O OR L)

PROPERTY ITEMIZATION	PROPERTY STOLEN/RECOVERED ITEMIZATION, USE THE FOLLOWING FORMAT			
	28. QUANTITY	29. ARTICLE NAME	30. BRAND NAME	31. SERIAL NUMBER

33. PROPERTY DAMAGE AMOUNT \$ _____ 34. INSURANCE COMPANY _____

35. OFFICER ASSAULTED Y N 36. ARSON Y N 37. STRUCTURE CODE _____ 38. DAMAGE \$ _____

47. CIB <input type="checkbox"/>	ENTERED <input type="checkbox"/>	CANCELLED <input type="checkbox"/>	48. TOTAL AMOUNT PROPERTY STOLEN \$ _____
NCIC <input type="checkbox"/>	<input type="checkbox"/>	<input type="checkbox"/>	
OTHER BROADCAST <input type="checkbox"/>	<input type="checkbox"/>	<input type="checkbox"/>	
			49. TOTAL AMOUNT PROPERTY RECOVERED \$ _____

50. IS REPORT CONTINUED? YES NO 51. CAUTION INDICATORS, ATLS ETC.

52. DATA PROCESS INFORMATION:
 COMPUTER ENTERED DATE _____
 MICROFILM INDEXED INITIAL _____
 IS CASE CLASSIFICATION CORRECT? Y N
 IF N HAS CORRECTION BEEN MADE? Y N
 53. FILE APPROVAL
 BY  DATE 03 08 99
 MCSQ 028 1/91

MANITOWOC COUNTY SHERIFF'S DEPARTMENT
FOLLOW-UP REPORT

Page: 2

CASE NUMBER: 599-00640 CLASSIFICATION: _____

INCIDENT: _____





DATE AND TIME: _____

REPORT CONTINUED:

I, Lt. O'Hearn, checked all 3 of the trailer parks, not coming up with any type of vehicle matching the description given to me by SERGIO. I had 2 trucks similar in nature to the one we are looking at. One was a 1986 Chevy vehicle bearing RP SSM356 which comes back to THOMAS PRESTON, and this vehicle was intact. Second was a 1988 Chevy vehicle with RP KMV111 which comes back to GEORGE VANSLUYS, and this vehicle was intact.

At this time, I am still waiting to hear from SERGIO as to the location and owner of the vehicle that he was operating so that can be checked.

This Crime Stopper report should still remain open. TKO Hearn  /bjc

0520 hrs. 1/22/99 Spoke with Sandra Moreno who owned the Suburban in question, she stated that she has damage to her vehicle in the windshield and rear bumper area, and this was due to the fact that her ex-husband did cause this damage. She stated that I could check the damage at anytime and that she would make the vehicle accessible for officers. She resides at  Johnson dr. MIWC Lot  Trail INN. Phone number  Blk and red. sub. As long as I find no further problems this CS can be closed. TKO 

S99 INZ U0041 | 63 | 01 | | 6,0 | 0,0,0

4. INCIDENT CS/S99-00242			
5. INCIDENT LOCATION CTH CR			
6. NAME- LAST-FIRST-MI Anonymous 2		7. D.O.B.	
8. ADDRESS		9. TX-HOME	
11. CITY	STATE	ZIP	10. TX-BUSINESS
12. DETAILS Inc. Requested for crime stopper report.			

18. ASSIGNED MTSO O'Hearn 9/2/99 4156	
19. REC. BY 456	20. DIS. BY
21. HOW REC'D. 1. 911 2. POLICE RADIO 3. PHONE 4. TTY 5. IN PERSON 6. ON VIEW 7. OFF. OFF DUTY 8. C.B. RADIO 9. OTHER	
22. TYPE OF REPORT 1. INCIDENT 2. ACCIDENT 3. CITATION 4. NONE	
23. STATUS 1. UNFOUNDED 2. PNL 3. OTHER 4. CLEARED 5. EXCEPT CLEARED	
24. DATE CLEARED 3/8/99	
25. OFFENSE TYPE 1. ADULT <input type="checkbox"/> NA <input checked="" type="checkbox"/> 2. JUVENILE <input type="checkbox"/> 3. UNKNOWN <input type="checkbox"/>	

14. REC'D	15. DISP	16. 10-23	17. 10-24
13. DAY			
SUN 1	THU 5		
MON 2	FRI 6		
TUE 3	SAT 7		
WED 4			

39. (CODE S-SUSPECT W-WITNESS V-VICTIM O-OTHER)	40. NAME-LAST	FIRST	MI	41. D.O.B.	42. ADDRESS	43. TELEPHONE
O	BURMEISTER	EMMANUEL	J			
O	GILPATRICK	JAMES	L		CTH T, Whitelaw	

01/21/99 @ 0400 Hrs.: I, Lt. O'Hearn, received a fax transmission, Crime Stopper report, from GARY SHEAHAN of TRPD. This information was relayed to our officer by Officer Strouf who received possible information on the suspect in the fatal hit and run accident on CTH CR. The information came from EMMANUEL BURMEISTER who stated, a few days after the accident, his son-in-law (JAMES GILPATRICK) showed up at his house with the grill on his red Blazer-type vehicle knocked out. It was indicated BURMEISTER did not see this himself, but his wife did. BURMEISTER could not provide the year of the vehicle, RP, or anything like that; however, he stated GILPATRICK lives in a house trailer off CTH T on the east side of the road, south of CTH K.

01/21/99 @ 0754 Hrs.: I found the residence which is just north of CTH V on the east side of the road. The address is [redacted] CTH T, Whitelaw. There was no vehicle in the driveway, and I met with the wife of GILPATRICK. She stated the Blazer they had owned they sold over 1 year ago. She stated she knew this for sure due to the fact they were separated at the time, had just gotten back together, got rid of the vehicle, and purchased the vehicle they have now which is a mini-van, Chrysler product. I left my card and advised her that her husband should contact me so we could clear up the matter in this incident.

01/21/99 @ 0822 Hrs.: I spoke with BURMEISTER and questioned him as to the Blazer-type vehicle. He stated he was confused on the make of the vehicle, that the son-in-law does not actually have a Blazer but has a mini-van.

At this point, I will be awaiting the return call from GILPATRICK reference his vehicle; but at this time, this does not prove to be a successful lead in this case.

TKO'Hearn /bjc

45. IF COMPLAINANT DIFFERENT THEN CALLER, ENTER NAME, ADDRESS, D.O.B., TELEPHONE.

46. IF CODE O (OTHER) IS USED IN FIELD #39, EXPLAIN.

INCIDENT REPORT:

NOTE: IF SECTION 22 ABOVE HAS NUMBER 4 CHECKED, DO NOT GO BEYOND THIS LINE WITHOUT RECORDS SECTION BEING ADVISED, OR NO RECORD ENTRIES WILL BE MADE BELOW THIS LINE.

PROPERTY VALUE	26. PROPERTY	A. CURRENCY	B. JEWELRY	C. FURS CLOTHING	D. VEHICLE (LOCAL)	E. OFFICE EQUIPMENT	F. RADIO, TV CAMERAS	G. FIREARMS	H. HOUSE-HOLD GOODS
	STOLEN	\$	\$	\$	\$	\$	\$	\$	\$
	RECOVERED	\$	\$	\$	\$	\$	\$	\$	\$
	26. PROPERTY	I. CONSUMABLES	J. LIVESTOCK	K. DRUGS	L. MARINE ITEMS	M. CONSTRUCTION ITEMS	N. LAWN AND GARDEN	O. SPORTING GOODS	P. MISC BICYCLE
	STOLEN	\$	\$	\$	\$	\$	\$	\$	\$
	RECOVERED	\$	\$	\$	\$	\$	\$	\$	\$

27. PROPERTY RECOVERED: LOCALLY _____ OTHER JURISDICTION _____ (INSERT O OR L)

PROPERTY ITEMIZATION	PROPERTY STOLEN/RECOVERED ITEMIZATION, USE THE FOLLOWING FORMAT				
	28. QUANTITY	29. ARTICLE NAME	30. BRAND NAME	31. SERIAL NUMBER	32. CODE
					S <input type="checkbox"/> R <input type="checkbox"/>
					S <input type="checkbox"/> R <input type="checkbox"/>
					S <input type="checkbox"/> R <input type="checkbox"/>
					S <input type="checkbox"/> R <input type="checkbox"/>
					S <input type="checkbox"/> R <input type="checkbox"/>

33. PROPERTY DAMAGE AMOUNT \$ _____ 34. INSURANCE COMPANY _____

35. OFFICER ASSAULTED Y N 36. ARSON Y N 37. STRUCTURE CODE _____ 38. DAMAGE \$ _____

47. CIB ENTERED CANCELLED
 NCIC
 OTHER BROADCAST

48. TOTAL AMOUNT PROPERTY STOLEN \$ _____

49. TOTAL AMOUNT PROPERTY RECOVERED \$ _____

50. IS REPORT CONTINUED? YES NO

51. CAUTION INDICATORS, ATLS ETC.

52. DATA PROCESS INFORMATION:

COMPUTER ENTERED DATE 3.8.99
 MICROFILM INDEXED INITIAL AS

53. FILE APPROVAL

IS CASE CLASSIFICATION CORRECT? N
 IF N HAS CORRECTION BEEN MADE? Y

BY [Signature] DATE 03 08 99

S99 IN 00044 1304 14014

INCIDENT CARD

4. INCIDENT
Found Vehicle Part

5. INCIDENT LOCATION
Gass Lk, South of Clover

6. NAME - LAST - FIRST - MI
Tyscher Craig

7. D.O.B.

8. ADDRESS
Clover Rd

9. TX-HOME

11. CITY STATE ZIP
Mantowice WI 53020

10. TX-BUSINESS

12. DETAILS
found a piece of
a vehicle, would
attach to grill

18. ASSIGNED
O'Connor 41015

19. REC. BY
924924

20. DIS. BY
924924

21. HOW REC'D.
1. 911
2. POLICE RADIO
3. PHONE
4. TTY
5. IN PERSON
6. ON VIEW
7. OFF. OFF DUTY
8. C.B. RADIO
9. OTHER

22. TYPE OF REPORT
1. INCIDENT
2. ACCIDENT
3. CITATION
4. NONE

23. STATUS
1. UNFOUNDED
2. PNL
3. OTHER
4. CLEARED
5. EXCEPT CLEARED

24. DATE CLEARED
01/25/99

25. OFFENSE TYPE
1. ADULT NA
2. JUVENILE
3. UNKNOWN

14. REC'D
15. DISP
16. 10-23
17. 10-24

13. DAY
SUN 1 TH 5
MON 2 FRI 6
TUE 3 SAT 7
WED 4

39. (CODE S-SUSPECT W-WITNESS V-VICTIM O-OTHER)				41. D.O.B.		42. ADDRESS		43. TELEPHONE	
CODE	40. NAME-LAST	FIRST	MI						

01/21/99 @ 0950 Hrs.: I, Deputy O'Connor, arrived on Gass Lake Rd, approximately 0.25 miles south of Clover Rd. I was informed there was a piece of vehicle near a field access which may be pertinent to the hit and run fatality which was being investigated by MTSO (see incident S99-00242). I located the piece which would be part of the air intake for an unknown vehicle. The piece was black and color and approximately 4" long. The item was brought to MTSO and given to the investigating officer, Lt. M. Bushman. I also took a Polaroid photograph of this item. POConnor *[Signature]* /bjc

45. IF COMPLAINANT DIFFERENT THEN CALLER, ENTER NAME, ADDRESS, D.O.B., TELEPHONE.

46. IF CODE O (OTHER) IS USED IN FIELD #39, EXPLAIN.

INCIDENT REPORT: NOTE: IF SECTION 22 ABOVE HAS NUMBER 4 CHECKED, DO NOT GO BEYOND THIS LINE WITHOUT RECORDS SECTION BEING ADVISED, OR NO RECORD ENTRIES WILL BE MADE BELOW THIS LINE.

PROPERTY VALUE	26. PROPERTY	A. CURRENCY	B. JEWELRY	C. FURS CLOTHING	D. VEHICLE (LOCAL)	E. OFFICE EQUIPMENT	F. RADIO, TV CAMERAS	G. FIREARMS	H. HOUSE-HOLD GOODS
	STOLEN	\$	\$	\$	\$	\$	\$	\$	\$
	RECOVERED	\$	\$	\$	\$	\$	\$	\$	\$
	26. PROPERTY	I. CONSUMABLES	J. LIVESTOCK	K. DRUGS	L. MARINE ITEMS	M. CONSTRUCTION ITEMS	N. LAWN AND GARDEN	O. SPORTING GOODS	P. MISC BICYCLE
STOLEN	\$	\$	\$	\$	\$	\$	\$	\$	
RECOVERED	\$	\$	\$	\$	\$	\$	\$	\$	

27. PROPERTY RECOVERED: LOCALLY _____ OTHER JURISDICTION _____ (INSERT O OR L)

PROPERTY ITEMIZATION	PROPERTY STOLEN/RECOVERED ITEMIZATION, USE THE FOLLOWING FORMAT				
	28. QUANTITY	29. ARTICLE NAME	30. BRAND NAME	31. SERIAL NUMBER	32. CODE
					S <input type="checkbox"/> R <input type="checkbox"/>
					S <input type="checkbox"/> R <input type="checkbox"/>
					S <input type="checkbox"/> R <input type="checkbox"/>
					S <input type="checkbox"/> R <input type="checkbox"/>

33. PROPERTY DAMAGE AMOUNT \$ _____

34. INSURANCE COMPANY _____

35. OFFICER ASSAULTED Y N 36. ARSON Y N 37. STRUCTURE CODE _____ 38. DAMAGE \$ _____

47. CIB ENTERED CANCELLED
 NCIC
 OTHER BROADCAST

48. TOTAL AMOUNT PROPERTY STOLEN \$ _____

49. TOTAL AMOUNT PROPERTY RECOVERED \$ _____

50. IS REPORT CONTINUED? YES NO

51. CAUTION INDICATORS, ATLS ETC.

52. DATA PROCESS INFORMATION:

COMPUTER ENTERED DATE 10/29/99
 MICROFILM INDEXED INITIAL DS

53. FILE APPROVAL

IS CASE CLASSIFICATION CORRECT? Y N
 IF N HAS CORRECTION BEEN MADE? Y N

BY [Signature] DATE 11/28/99

S99 No 00401 16301 521000

IDENT: CS/599-00242

6. NAME - LAST - FIRST - MI: ANONYMOUS (S)

8. ADDRESS

11. CITY STATE ZIP 9. TX-HOME 10. TX-BUSINESS

12. DETAILS: Rpts observing a blue pickup with right front grill damage. RP# AH13946 Parked at Kiwik Trip, Meadow Dr.

14. REC'D 15. DISP 16. 10-23 17. 10-24 13. DAY: SUN 1, MON 2, TUE 3, WED 4, THU 5, FRI 6, SAT 7

MANITOWOC COUNTY SHERIFF INCIDENT CARD

18. ASSIGNED: 989 5/14/99

19. REC. BY: 901 20. DIS. BY: - 22. TYPE OF REPORT: 1. INCIDENT (circled), 2. ACCIDENT, 3. CITATION, 4. NONE

21. HOW REC'D: 1. 911, 2. POLICE RADIO, 3. PHONE (circled), 4. TTY, 5. IN PERSON, 6. ON VIEW, 7. OFF. OFF DUTY, 8. C.B. RADIO, 9. OTHER 23. STATUS: 1. UNFOUNDED, 2. PNL, 3. OTHER (circled), 4. CLEARED, 5. EXCEPT CLEARED

24. DATE CLEARED: 12/08/99 25. OFFENSE TYPE: 1. ADULT, 2. JUVENILE, 3. UNKNOWN, NA (checked)

Table with 4 columns: 39. (CODE S-SUSPECT W-WITNESS V-VICTIM O-OTHER), 40. NAME-LAST, FIRST, MI, 41. D.O.B., 42. ADDRESS, 43. TELEPHONE

11/14/99 Vehicle does not fit the profile of the suspect vehicle. M.J. Bush

S99 No 004

45. IF COMPLAINANT DIFFERENT THEN CALLER, ENTER NAME, ADDRESS, D.O.B., TELEPHONE.

46. IF CODE O (OTHER) IS USED IN FIELD #39, EXPLAIN.

INCIDENT REPORT: NOTE: IF SECTION 22 ABOVE HAS NUMBER 4 CHECKED, DO NOT GO BEYOND THIS LINE WITHOUT RECORDS SECTION BEING ADVISED, OR NO RECORD ENTRIES WILL BE MADE BELOW THIS LINE.

PROPERTY VALUE	26. PROPERTY	A. CURRENCY	B. JEWELRY	C. FURS CLOTHING	D. VEHICLE (LOCAL)	E. OFFICE EQUIPMENT	F. RADIO, TV CAMERAS	G. FIREARMS	H. HOUSE-HOLD GOODS
	STOLEN	\$	\$	\$	\$	\$	\$	\$	\$
	RECOVERED	\$	\$	\$	\$	\$	\$	\$	\$
	26. PROPERTY	I. CONSUM-ABLES	J. LIVESTOCK	K. DRUGS	L. MARINE ITEMS	M. CONSTRUCTION ITEMS	N. LAWN AND GARDEN	O. SPORTING GOODS	P. MISC BICYCLE
STOLEN	\$	\$	\$	\$	\$	\$	\$	\$	
RECOVERED	\$	\$	\$	\$	\$	\$	\$	\$	

27. PROPERTY RECOVERED: LOCALLY ____ OTHER JURISDICTION ____ (INSERT O OR L)

PROPERTY ITEMIZATION	PROPERTY STOLEN/RECOVERED ITEMIZATION, USE THE FOLLOWING FORMAT				
	28. QUANTITY	29. ARTICLE NAME	30. BRAND NAME	31. SERIAL NUMBER	32. CODE
					S R
					<input type="checkbox"/> <input type="checkbox"/>
					S R
					<input type="checkbox"/> <input type="checkbox"/>
				S R	
				<input type="checkbox"/> <input type="checkbox"/>	
				S R	
				<input type="checkbox"/> <input type="checkbox"/>	
				S R	
				<input type="checkbox"/> <input type="checkbox"/>	

33. PROPERTY DAMAGE AMOUNT \$ _____

34. INSURANCE COMPANY _____

35. OFFICER ASSAULTED Y N

36. ARSON Y N

37. STRUCTURE CODE _____

38. DAMAGE \$ _____

47. CIB ENTERED CANCELLED
 NCIC
 OTHER BROADCAST

48. TOTAL AMOUNT PROPERTY STOLEN \$ _____

49. TOTAL AMOUNT PROPERTY RECOVERED \$ _____

50. IS REPORT CONTINUED? YES NO

51. CAUTION INDICATORS, ATLS ETC.

52. DATA PROCESS INFORMATION:

COMPUTER ENTERED DATE 13.8.99
 MICROFILM INDEXED INITIAL KS

53. FILE APPROVAL

IS CASE CLASSIFICATION CORRECT?
 IF N HAS CORRECTION BEEN MADE?

N
 N

BY [Signature] DATE 03.08.99

10-21-99 11:29 AM

4. INCIDENT
CS/S99-00242

5. INCIDENT LOCATION
CTHC.

6. NAME- LAST-FIRST-MI
[REDACTED]

7. D.O.B.
[REDACTED]

8. ADDRESS
[REDACTED]

9. TX-HOME
[REDACTED]

11. CITY STATE ZIP
[REDACTED]

10. TX-BUSINESS
[REDACTED]

12. DETAILS
Reports seeing an orange p.u truck older w/ broken grill across from the Co Hwy Pit in a cinder block garage on C

INCIDENT CARD

18. ASSIGNED
M159 929
Bushman H/W

19. REC. BY
935

20. DIS. BY

22. TYPE OF REPORT
1. INCIDENT
2. ACCIDENT
3. CITATION
4. NONE

21. HOW REC'D.
1. 911
2. POLICE RADIO
3. PHONE
4. TTY
5. IN PERSON
6. ON VIEW
7. OFF. OFF DUTY
8. C.B. RADIO
9. OTHER

23. STATUS
1. UNFOUNDED
2. PNL
3. OTHER
4. CLEARED
5. EXCEPT CLEARED

24. DATE CLEARED
10/20/99

25. OFFENSE TYPE
1. ADULT NA
2. JUVENILE
3. UNKNOWN

21A. M.O.
[REDACTED]

14. REC'D.	15. DISP	16. 10-23	17. 10-24
SUN 1	THU 5	MON 2	FRI 6
TUE 3	SAT 7	WED 4	

39. (CODE S-SUSPECT W-WITNESS V-VICTIM O-OTHER)				42. ADDRESS		43. TELEPHONE
CODE	40. NAME-LAST	FIRST	MI	41. D.O.B.		

01/14/99 @ 1640 & 1730 Hrs.: I, Lt. M. Bushman, attempted contact at [REDACTED] CTH C; however, no one was home. The vehicle was observed in the garage; however, the front was not visible, and the rear RP was covered with snow.

01/15/99 @ 1105 Hrs.: Contact was made with the owner of the property, and the vehicle was viewed without problems. The vehicle is a 1981 Chevrolet with the grill knocked out but no other damage. It has large truck tires. This would not be the suspect vehicle.

MJBushman [Signature] /bjc

45. IF COMPLAINANT DIFFERENT THEN CALLER, ENTER NAME, ADDRESS, D.O.B., TELEPHONE.

46. IF CODE O (OTHER) IS USED IN FIELD #39, EXPLAIN.

INCIDENT REPORT: NOTE: IF SECTION 22 ABOVE HAS NUMBER 4 CHECKED, DO NOT GO BEYOND THIS LINE WITHOUT RECORDS SECTION BEING ADVISED, OR NO RECORD ENTRIES WILL BE MADE BELOW THIS LINE.

PROPERTY VALUE	26. PROPERTY	A. CURRENCY	B. JEWELRY	C. FURS CLOTHING	D. VEHICLE (LOCAL)	E. OFFICE EQUIPMENT	F. RADIO, TV CAMERAS	G. FIREARMS	H. HOUSE-HOLD GOODS
	STOLEN	\$	\$	\$	\$	\$	\$	\$	\$
	RECOVERED	\$	\$	\$	\$	\$	\$	\$	\$
	26. PROPERTY	I. CONSUMABLES	J. LIVESTOCK	K. DRUGS	L. MARINE ITEMS	M. CONSTRUCTION ITEMS	N. LAWN AND GARDEN	O. SPORTING GOODS	P. MISC BICYCLE
	STOLEN	\$	\$	\$	\$	\$	\$	\$	\$
	RECOVERED	\$	\$	\$	\$	\$	\$	\$	\$

27. PROPERTY RECOVERED: LOCALLY _____ OTHER JURISDICTION _____ (INSERT O OR L)

PROPERTY ITEMIZATION	PROPERTY STOLEN/RECOVERED ITEMIZATION, USE THE FOLLOWING FORMAT				
	28. QUANTITY	29. ARTICLE NAME	30. BRAND NAME	31. SERIAL NUMBER	32. CODE
					S R <input type="checkbox"/> <input type="checkbox"/>
					S R <input type="checkbox"/> <input type="checkbox"/>
					S R <input type="checkbox"/> <input type="checkbox"/>
					S R <input type="checkbox"/> <input type="checkbox"/>
					S R <input type="checkbox"/> <input type="checkbox"/>

33. PROPERTY DAMAGE AMOUNT \$ _____ 34. INSURANCE COMPANY _____

35. OFFICER ASSAULTED Y N 36. ARSON Y N 37. STRUCTURE CODE _____ 38. DAMAGE \$ _____

47. CIB	ENTERED	CANCELLED	48. TOTAL AMOUNT PROPERTY STOLEN \$ _____
	<input type="checkbox"/>	<input type="checkbox"/>	
	NCIC	<input type="checkbox"/>	
OTHER BROADCAST	<input type="checkbox"/>	<input type="checkbox"/>	49. TOTAL AMOUNT PROPERTY RECOVERED \$ _____

50. IS REPORT CONTINUED? YES NO 51. CAUTION INDICATORS, ATLS ETC.

52. DATA PROCESS INFORMATION:

COMPUTER ENTERED DATE 01/20/99

MICROFILM INDEXED INITIAL KS

IS CASE CLASSIFICATION CORRECT? Y N

IF N HAS CORRECTION BEEN MADE? Y N

53. FILE APPROVAL

BY GK DATE 01/20/99

4. INCIDENT
CS/S99-00242

5. INCIDENT LOCATION
[REDACTED]

6. NAME - LAST - FIRST - MI
Anonymous (2)

7. D.O.B.

8. ADDRESS

9. TX-HOME

11. CITY STATE ZIP

10. TX-BUSINESS

12. DETAILS
 Caller states neighbor, first name of Shane, lives white trailer house to the north of the above address. Caller states the Blazer is black in color, would have 1/3 of the Grill missing, (which is grey) and the Drivers side front end is smashed in some what.

18. ASSIGNED
MISA 924
CALUMET CO

19. REC. BY
924

20. DIS. BY

21. HOW REC'D.
 1. 911
 2. POLICE RADIO
 3. PHONE
 4. TTY
 5. IN PERSON
 6. ON VIEW
 7. OFF. OFF DUTY
 8. C.B. RADIO
 9. OTHER

22. TYPE OF REPORT
 1. INCIDENT
 2. ACCIDENT
 3. CITATION
 4. NONE

23. STATUS
 1. UNFOUNDED
 2. PNL
 3. OTHER
 4. CLEARED
 5. EXCEPT CLEARED

24. DATE CLEARED
10/19/99

25. OFFENSE TYPE
 1. ADULT NA
 2. JUVENILE
 3. UNKNOWN

14. REC'D	15. DISP.	16. 10-23	17. 10-24
13. DAY			
SUN 1	THU 5		
MON 2	FRI 6		
TUE 3	SAT 7		
WED 4			

39. (CODE S-SUSPECT W-WITNESS V-VICTIM O-OTHER)						
CODE	40. NAME-LAST	FIRST	MI	41. D.O.B.	42. ADDRESS	43. TELEPHONE

1-14-99 1500 Call placed to CASO and they were asked to investigate. I received a call back at 1930 indicating that this is not the vehicle.

Lt. Thorrrington
 LT

45. IF COMPLAINANT DIFFERENT THEN CALLER, ENTER NAME, ADDRESS, D.O.B., TELEPHONE.

46. IF CODE O (OTHER) IS USED IN FIELD #39, EXPLAIN.

INCIDENT REPORT: NOTE: IF SECTION 22 ABOVE HAS NUMBER 4 CHECKED, DO NOT GO BEYOND THIS LINE WITHOUT RECORDS SECTION BEING ADVISED, OR NO RECORD ENTRIES WILL BE MADE BELOW THIS LINE.

PROPERTY VALUE	26. PROPERTY	A. CURRENCY	B. JEWELRY	C. FURS CLOTHING	D. VEHICLE (LOCAL)	E. OFFICE EQUIPMENT	F. RADIO, TV CAMERAS	G. FIREARMS	H. HOUSE-HOLD GOODS
	STOLEN	\$	\$	\$	\$	\$	\$	\$	\$
	RECOVERED	\$	\$	\$	\$	\$	\$	\$	\$
	26. PROPERTY	I. CONSUMABLES	J. LIVESTOCK	K. DRUGS	L. MARINE ITEMS	M. CONSTRUCTION ITEMS	N. LAWN AND GARDEN	O. SPORTING GOODS	P. MISC BICYCLE
	STOLEN	\$	\$	\$	\$	\$	\$	\$	\$
	RECOVERED	\$	\$	\$	\$	\$	\$	\$	\$

27. PROPERTY RECOVERED: LOCALLY _____ OTHER JURISDICTION _____ (INSERT O OR L)

PROPERTY ITEMIZATION	PROPERTY STOLEN/RECOVERED ITEMIZATION, USE THE FOLLOWING FORMAT				
	28. QUANTITY	29. ARTICLE NAME	30. BRAND NAME	31. SERIAL NUMBER	32. CODE
					S R <input type="checkbox"/> <input type="checkbox"/>
					S R <input type="checkbox"/> <input type="checkbox"/>
					S R <input type="checkbox"/> <input type="checkbox"/>
					S R <input type="checkbox"/> <input type="checkbox"/>
					S R <input type="checkbox"/> <input type="checkbox"/>

33. PROPERTY DAMAGE AMOUNT \$ _____

34. INSURANCE COMPANY _____

35. OFFICER ASSAULTED Y N 36. ARSON Y N 37. STRUCTURE CODE _____ 38. DAMAGE \$ _____

47. CIB ENTERED CANCELLED
 NCIC
 OTHER BROADCAST

48. TOTAL AMOUNT PROPERTY STOLEN \$ _____

49. TOTAL AMOUNT PROPERTY RECOVERED \$ _____

50. IS REPORT CONTINUED? YES NO

51. CAUTION INDICATORS, ATLS ETC.

52. DATA PROCESS INFORMATION:

COMPUTER ENTERED DATE 01/19/99

MICROFILM INDEXED INITIAL KS

IS CASE CLASSIFICATION CORRECT? Y N
 IF N HAS CORRECTION BEEN MADE? N

53. FILE APPROVAL

BY QR DATE 01/19/99

INCIDENT CARD

000 IV 00420 10,510,11 10,000,00

4. INCIDENT
CS / See 599-00242

5. INCIDENT LOCATION

6. NAME - LAST - FIRST - MI [REDACTED] 7. D.O.B. [REDACTED]

8. ADDRESS [REDACTED] 9. TX-HOME [REDACTED]

11. CITY [REDACTED] STATE [REDACTED] ZIP [REDACTED] 10. TX-BUSINESS [REDACTED]

12. DETAILS
COMPL. IS EMPLOYED @ SHORELINE CREDIT UNION IN TR.; AND REPOSSESSED A '92 DODGE CARAVAN, GREY IN COLOR, 01-14-99 (SEE ATTACHED CS FORM)

18. ASSIGNED
MTSO 929

19. REC. BY 930 20. DIS. BY 930

22. TYPE OF REPORT
① INCIDENT
2. ACCIDENT
3. CITATION
4. NONE

21. HOW REC'D.
1. 911
2. POLICE RADIO
③ PHONE CS
4. TTY
5. IN PERSON
6. ON VIEW
7. OFF. OFF DUTY
8. C.B. RADIO
9. OTHER

23. STATUS
1. UNFOUNDED
2. PNL
③ OTHER
4. CLEARED
5. EXCEPT CLEARED

24. DATE CLEARED 03 08 99

25. OFFENSE TYPE
1. ADULT NA
2. JUVENILE
3. UNKNOWN

14. REC'D 15. DISP 16. 10-23 17. 10-24

13. DAY
SUN 1 THU 5
MON 2 FR ⑥
TUE 3 SAT 7
WED 4

39. (CODE S-SUSPECT W-WITNESS V-VICTIM O-OTHER)

CODE	40. NAME-LAST	FIRST	MI	41. D.O.B.	42. ADDRESS	43. TELEPHONE
0	[REDACTED]	[REDACTED]	[REDACTED]	[REDACTED]	[REDACTED]	[REDACTED]

01/19/99 @ 1920 Hrs.: I, Sgt. Seim, made telephone contact with [REDACTED]. I informed [REDACTED] the 1992 Dodge Caravan that she was concerned about would not match the description of the hit and run vehicle involved in the fatal hit and run on CTH CR. JSeim /bjc

45. IF COMPLAINANT DIFFERENT THEN CALLER, ENTER NAME, ADDRESS, D.O.B., TELEPHONE.

46. IF CODE O (OTHER) IS USED IN FIELD #39, EXPLAIN.

INCIDENT REPORT: NOTE: IF SECTION 22 ABOVE HAS NUMBER 4 CHECKED, DO NOT GO BEYOND THIS LINE WITHOUT RECORDS SECTION BEING ADVISED, OR NO RECORD ENTRIES WILL BE MADE BELOW THIS LINE.

P R O P E R T Y V A L U E	26. PROPERTY	A. CURRENCY	B. JEWELRY	C. FURS CLOTHING	D. VEHICLE (LOCAL)	E. OFFICE EQUIPMENT	F. RADIO, TV CAMERAS	G. FIREARMS	H. HOUSE-HOLD GOODS
	STOLEN	\$	\$	\$	\$	\$	\$	\$	\$
	RECOVERED	\$	\$	\$	\$	\$	\$	\$	\$
	26. PROPERTY	I. CONSUMABLES	J. LIVESTOCK	K. DRUGS	L. MARINE ITEMS	M. CONSTRUCTION ITEMS	N. LAWN AND GARDEN	O. SPORTING GOODS	P. MISC BICYCLE
STOLEN	\$	\$	\$	\$	\$	\$	\$	\$	
RECOVERED	\$	\$	\$	\$	\$	\$	\$	\$	

27. PROPERTY RECOVERED: LOCALLY _____ OTHER JURISDICTION _____ (INSERT O OR L)

P R O P E R T Y I T E M I Z A T I O N	PROPERTY STOLEN/RECOVERED ITEMIZATION, USE THE FOLLOWING FORMAT				
	28. QUANTITY	29. ARTICLE NAME	30. BRAND NAME	31. SERIAL NUMBER	32. CODE
					S R <input type="checkbox"/> <input type="checkbox"/>
					S R <input type="checkbox"/> <input type="checkbox"/>
					S R <input type="checkbox"/> <input type="checkbox"/>
					S R <input type="checkbox"/> <input type="checkbox"/>

33. PROPERTY DAMAGE AMOUNT \$ _____ 34. INSURANCE COMPANY _____

35. OFFICER ASSAULTED Y N 36. ARSON Y N 37. STRUCTURE CODE _____ 38. DAMAGE \$ _____

47. CIB	ENTERED <input type="checkbox"/>	CANCELLED <input type="checkbox"/>	48. TOTAL AMOUNT PROPERTY STOLEN \$ _____
NCIC	<input type="checkbox"/>	<input type="checkbox"/>	
OTHER BROADCAST	<input type="checkbox"/>	<input type="checkbox"/>	49. TOTAL AMOUNT PROPERTY RECOVERED \$ _____

50. IS REPORT CONTINUED? YES NO 51. CAUTION INDICATORS, ATLS ETC.

52. DATA PROCESS INFORMATION:

COMPUTER ENTERED DATE 3.8.99

MICROFILM INDEXED INITIAL KS

IS CASE CLASSIFICATION CORRECT? Y N

IF N HAS CORRECTION BEEN MADE? Y N

53. FILE APPROVAL

BY [Signature] DATE 3.8.99

4. INCIDENT CS/99-0024

5. INCIDENT LOCATION

6. NAME- LAST-FIRST-MI Anonymous (2) 7. D.O.B.

8. ADDRESS 9. TX-HOME

11. CITY STATE ZIP 10. TX-BUSINESS

12. DETAILS
Rpts observing grey old truck
w/blk & beo paint missing
grill. Seen in area of
Lincoln HS. Hasnt seen since

14. REC'D	15. DISP	16. 10-23	17. 10-24
13. DAY			
SUN 1	THU 5		
MON 2	FRI 6		
TUE 3	SAT 7		
WED 4			

18. ASSIGNED 929

19. REC. BY 901 20. DIS. BY

21. HOW REC'D.
 1. 911
 2. POLICE RADIO
 3. PHONE
 4. TTY
 5. IN PERSON
 6. ON VIEW
 7. OFF. OFF DUTY
 8. C.B. RADIO
 9. OTHER

22. TYPE OF REPORT
 1. INCIDENT
 2. ACCIDENT
 3. CITATION
 4. NONE

23. STATUS
 1. UNFOUNDED
 2. PNL
 3. OTHER
 4. CLEARED
 5. EXCEPT CLEARED

24. DATE CLEARED 03 08 99

25. OFFENSE TYPE
 1. ADULT NA
 2. JUVENILE
 3. UNKNOWN

39. (CODE S-SUSPECT W-WITNESS V-VICTIM O-OTHER)

CODE	40. NAME-LAST	FIRST	MI	41. D.O.B.	42. ADDRESS	43. TELEPHONE

accident. Caller states that the vehicle was seen almost daily riding around Lincoln HS. She has not seen it since the accident. No plate number obtained. No operator description. Unknown where vehicle parks or if the operator is a student at the High School.

45. IF COMPLAINANT DIFFERENT THEN CALLER, ENTER NAME, ADDRESS, D.O.B., TELEPHONE.

46. IF CODE O (OTHER) IS USED IN FIELD #39, EXPLAIN.

INCIDENT REPORT: NOTE: IF SECTION 22 ABOVE HAS NUMBER 4 CHECKED, DO NOT GO BEYOND THIS LINE WITHOUT RECORDS SECTION BEING ADVISED, OR NO RECORD ENTRIES WILL BE MADE BELOW THIS LINE.

PROPERTY VALUE	26. PROPERTY	A. CURRENCY	B. JEWELRY	C. FURS CLOTHING	D. VEHICLE (LOCAL)	E. OFFICE EQUIPMENT	F. RADIO, TV CAMERAS	G. FIREARMS	H. HOUSE-HOLD GOODS
	STOLEN	\$	\$	\$	\$	\$	\$	\$	\$
	RECOVERED	\$	\$	\$	\$	\$	\$	\$	\$
	26. PROPERTY	I. CONSUMABLES	J. LIVESTOCK	K. DRUGS	L. MARINE ITEMS	M. CONSTRUCTION ITEMS	N. LAWN AND GARDEN	O. SPORTING GOODS	P. MISC BICYCLE
	STOLEN	\$	\$	\$	\$	\$	\$	\$	\$
	RECOVERED	\$	\$	\$	\$	\$	\$	\$	\$

27. PROPERTY RECOVERED: LOCALLY _____ OTHER JURISDICTION _____ (INSERT O OR L)

PROPERTY ITEMIZATION	PROPERTY STOLEN/RECOVERED ITEMIZATION, USE THE FOLLOWING FORMAT				
	28. QUANTITY	29. ARTICLE NAME	30. BRAND NAME	31. SERIAL NUMBER	
					S R <input type="checkbox"/> <input type="checkbox"/>
					S R <input type="checkbox"/> <input type="checkbox"/>
					S R <input type="checkbox"/> <input type="checkbox"/>
					S R <input type="checkbox"/> <input type="checkbox"/>

33. PROPERTY DAMAGE AMOUNT \$ _____ 34. INSURANCE COMPANY _____

35. OFFICER ASSAULTED Y N 36. ARSON Y N 37. STRUCTURE CODE _____ 38. DAMAGE \$ _____

47. CIB	ENTERED <input type="checkbox"/>	CANCELLED <input type="checkbox"/>	48. TOTAL AMOUNT PROPERTY STOLEN \$ _____
NCIC	<input type="checkbox"/>	<input type="checkbox"/>	
OTHER BROADCAST	<input type="checkbox"/>	<input type="checkbox"/>	
			49. TOTAL AMOUNT PROPERTY RECOVERED \$ _____

50. IS REPORT CONTINUED? YES NO 51. CAUTION INDICATORS, ATLS ETC.

52. DATA PROCESS INFORMATION:

COMPUTER ENTERED DATE 3.8.99

MICROFILM INDEXED INITIAL AS

IS CASE CLASSIFICATION CORRECT? Y N

IF N HAS CORRECTION BEEN MADE? Y N

53. FILE APPROVAL

BY [Signature] DATE 03.07.99

S99 No 00426 1630.11 521000

4. INCIDENT <i>CS</i>				599-00242			
5. INCIDENT LOCATION							
6. NAME - LAST - FIRST - MI <i>Anonymous</i>						7. D.O.B.	
8. ADDRESS				9. TX-HOME			
11. CITY		STATE		ZIP		10. TX-BUSINESS	
12. DETAILS <i>see attached</i>							

14. REC'D	15. DISP	16. 10-23	17. 10-24
13. DAY			
SUN 1	THU 5		
MON 2	FRI 6		
TUE 3	SAT 7		
WED 4			

INCIDENT CARD		
18. ASSIGNED		
<i>Seim</i>		<i>MTSO</i>
		<i>4180</i>
19. REC. BY <i>921</i>		20. DIS. BY
21. HOW REC'D.		22. TYPE OF REPORT
1. 911		1. INCIDENT
2. POLICE RADIO		2. ACCIDENT
3. PHONE		3. CITATION
4. TTY		4. NONE
5. IN PERSON		23. STATUS
6. ON VIEW		1. UNFOUNDED
7. OFF. OFF DUTY		2. PNL
8. C.B. RADIO		3. OTHER
9. OTHER		4. CLEARED
21A. M.O.		5. EXCEPT CLEARED
		24. DATE CLEARED <i>03 18 99</i>
		25. OFFENSE TYPE
		1. ADULT <input type="checkbox"/> NA <input type="checkbox"/>
		2. JUVENILE <input type="checkbox"/>
		3. UNKNOWN <input type="checkbox"/>

39. (CODE S-SUSPECT W-WITNESS V-VICTIM O-OTHER)				42. ADDRESS				43. TELEPHONE		
CODE	40. NAME-LAST	FIRST	MI	41. D.O.B.						

01/18/99 @ 1830 Hrs.: I, Sgt. Seim, checked the area of S 40th St and did locate a 1997 Chevy S10, dark blue in color, matching the description given from this Crime Stopper report; however, the age of the vehicle and the damage does not match that of the hit and run vehicle from the fatal on CTH CR. JSeim /bjc

PROPERTY

45. IF COMPLAINANT DIFFERENT THEN CALLER, ENTER NAME, ADDRESS, D.O.B., TELEPHONE.

46. IF CODE O (OTHER) IS USED IN FIELD #39, EXPLAIN.

INCIDENT REPORT: NOTE: IF SECTION 22 ABOVE HAS NUMBER 4 CHECKED, DO NOT GO BEYOND THIS LINE WITHOUT RECORDS SECTION BEING ADVISED, OR NO RECORD ENTRIES WILL BE MADE BELOW THIS LINE.

PROPERTY VALUE	26. PROPERTY	A. CURRENCY	B. JEWELRY	C. FURS CLOTHING	D. VEHICLE (LOCAL)	E. OFFICE EQUIPMENT	F. RADIO, TV CAMERAS	G. FIREARMS	H. HOUSE-HOLD GOODS
	STOLEN	\$	\$	\$	\$	\$	\$	\$	\$
	RECOVERED	\$	\$	\$	\$	\$	\$	\$	\$
	26. PROPERTY	I. CONSUMABLES	J. LIVESTOCK	K. DRUGS	L. MARINE ITEMS	M. CONSTRUCTION ITEMS	N. LAWN AND GARDEN	O. SPORTING GOODS	P. MISC BICYCLE
STOLEN	\$	\$	\$	\$	\$	\$	\$	\$	
RECOVERED	\$	\$	\$	\$	\$	\$	\$	\$	

27. PROPERTY RECOVERED: LOCALLY _____ OTHER JURISDICTION _____ (INSERT O OR L)

PROPERTY ITEMIZATION	PROPERTY STOLEN/RECOVERED ITEMIZATION, USE THE FOLLOWING FORMAT				
	28. QUANTITY	29. ARTICLE NAME	30. BRAND NAME	31. SERIAL NUMBER	32. CODE
					S R <input type="checkbox"/> <input type="checkbox"/>
					S R <input type="checkbox"/> <input type="checkbox"/>
					S R <input type="checkbox"/> <input type="checkbox"/>
					S R <input type="checkbox"/> <input type="checkbox"/>

33. PROPERTY DAMAGE AMOUNT \$ _____

34. INSURANCE COMPANY _____

35. OFFICER ASSAULTED Y N

36. ARSON Y N

37. STRUCTURE CODE _____

38. DAMAGE \$ _____

47. CIB ENTERED CANCELLED
 NCIC
 OTHER BROADCAST

48. TOTAL AMOUNT PROPERTY STOLEN \$ _____

49. TOTAL AMOUNT PROPERTY RECOVERED \$ _____

50. IS REPORT CONTINUED? YES NO

51. CAUTION INDICATORS, ATLS ETC.

52. DATA PROCESS INFORMATION:

COMPUTER ENTERED DATE 3/8/99
 MICROFILM INDEXED INITIAL AS

53. FILE APPROVAL

IS CASE CLASSIFICATION CORRECT? Y N
 IF N HAS CORRECTION BEEN MADE? Y N

BY [Signature] DATE 3/8/99

4. INCIDENT

CS/99-00242

5. INCIDENT LOCATION

6. NAME - LAST-FIRST-MI

8. ADDRESS

11. CITY

STATE

ZIP

9. TX-HOME

10. TX-BUSINESS

12. DETAILS

See attached

18. ASSIGNED

19. REC. BY

901

20. DIS. BY

22. TYPE OF REPORT

- 1. INCIDENT
- 2. ACCIDENT
- 3. CITATION
- 4. NONE

21. HOW REC'D.

- 1. 911
- 2. POLICE RADIO
- 3. PHONE
- 4. TTY
- 5. IN PERSON
- 6. ON VIEW
- 7. OFF. OFF DUTY
- 8. C.B. RADIO
- 9. OTHER

23. STATUS

- 1. UNFOUNDED
- 2. PNL
- 3. OTHER
- 4. CLEARED
- 5. EXCEPT CLEARED

24. DATE

CLEARED 03/08/99

25. OFFENSE TYPE

- 1. ADULT NA
- 2. JUVENILE
- 3. UNKNOWN

14. REC'D

15. DISP

16. 10-23

17. 10-24

13. DAY

- SUN 1
- MON 2
- TUE 3
- WED 4
- THU 5
- FRI 6
- SAT 7

39. (CODE S-SUSPECT W-WITNESS V-VICTIM O-OTHER)

CODE	40. NAME-LAST	FIRST	MI	41. D.O.B.	42. ADDRESS	43. TELEPHONE

Unable to track, no plate given

45. IF COMPLAINANT DIFFERENT THEN CALLER, ENTER NAME, ADDRESS, D.O.B., TELEPHONE.

46. IF CODE O (OTHER) IS USED IN FIELD #39, EXPLAIN.

INCIDENT REPORT: NOTE: IF SECTION 22 ABOVE HAS NUMBER 4 CHECKED, DO NOT GO BEYOND THIS LINE WITHOUT RECORDS SECTION BEING ADVISED, OR NO RECORD ENTRIES WILL BE MADE BELOW THIS LINE.

PROPERTY VALUE	26. PROPERTY	A. CURRENCY	B. JEWELRY	C. FURS CLOTHING	D. VEHICLE (LOCAL)	E. OFFICE EQUIPMENT	F. RADIO, TV CAMERAS	G. FIREARMS	H. HOUSE-HOLD GOODS
	STOLEN	\$	\$	\$	\$	\$	\$	\$	\$
	RECOVERED	\$	\$	\$	\$	\$	\$	\$	\$
	26. PROPERTY	I. CONSUMABLES	J. LIVESTOCK	K. DRUGS	L. MARINE ITEMS	M. CONSTRUCTION ITEMS	N. LAWN AND GARDEN	O. SPORTING GOODS	P. MISC BICYCLE
	STOLEN	\$	\$	\$	\$	\$	\$	\$	\$
	RECOVERED	\$	\$	\$	\$	\$	\$	\$	\$

27. PROPERTY RECOVERED: LOCALLY _____ OTHER JURISDICTION _____ (INSERT O OR L)

PROPERTY ITEMIZATION	PROPERTY STOLEN/RECOVERED ITEMIZATION, USE THE FOLLOWING FORMAT				
	28. QUANTITY	29. ARTICLE NAME	30. BRAND NAME	31. SERIAL NUMBER	32. CODE
					S R <input type="checkbox"/> <input type="checkbox"/>
					S R <input type="checkbox"/> <input type="checkbox"/>
					S R <input type="checkbox"/> <input type="checkbox"/>
					S R <input type="checkbox"/> <input type="checkbox"/>

33. PROPERTY DAMAGE AMOUNT \$ _____ 34. INSURANCE COMPANY _____

35. OFFICER ASSAULTED Y N 36. ARSON Y N 37. STRUCTURE CODE _____ 38. DAMAGE \$ _____

47. CIB	ENTERED <input type="checkbox"/>	CANCELLED <input type="checkbox"/>	48. TOTAL AMOUNT PROPERTY STOLEN \$ _____
NCIC	<input type="checkbox"/>	<input type="checkbox"/>	
OTHER BROADCAST	<input type="checkbox"/>	<input type="checkbox"/>	
			49. TOTAL AMOUNT PROPERTY RECOVERED \$ _____

50. IS REPORT CONTINUED? YES NO 51. CAUTION INDICATORS, ATLS ETC.

52. DATA PROCESS INFORMATION:

COMPUTER ENTERED DATE 3.8.99

MICROFILM INDEXED INITIAL KS

IS CASE CLASSIFICATION CORRECT? Y N

IF N HAS CORRECTION BEEN MADE? Y N

53. FILE APPROVAL

BY [Signature] DATE 0899

4. INCIDENT *rec info / 599-00242*

5. INCIDENT LOCATION *CR*

6. NAME - LAST - FIRST - MI *MTSO* 7. D.O.B.

8. ADDRESS 9. TX-HOME

11. CITY STATE ZIP 10. TX-BUSINESS

12. DETAILS *rec'd info, re: found items*

18. ASSIGNED *Jost 449*

19. REC. BY *921* 20. DIS. BY *3* 22. TYPE OF REPORT

21. HOW REC'D. 23. STATUS

24. DATE CLEARED *10/19/99*

25. OFFENSE TYPE

14. REC'D. 15. DISP. 16. 10-23 17. 10-24

13. DAY

SUN 1 THU 5
 MON 2 **FRI 6**
 TUE 3 SAT 7
 WED 4

39. (CODE S-SUSPECT W-WITNESS V-VICTIM O-OTHER)							
CODE	40. NAME-LAST	FIRST	MI	41. D.O.B.	42. ADDRESS	43. TELEPHONE	
0	HYNEK	SYLVIA	A		S. 36th St. Manitowoc		
0	HOCHSTETLER	KIRK	A		Route 10, Germantown NY 42526	518/	

01-15-99 @ 1401 hrs.: I, Deputy Jost, made contact at [redacted] CTH CR ref. to some vehicle parts that had been found at that location. Upon arrival, I made contact with KIRK HOCHSTETLER and he directed me to a red pickup truck that was parked in the driveway. In the back of the pickup truck was a piece of plastic from a veh. that appeared to be from a newer style car. It would have been a section of head light housing, having the numbers stamped into it towards the bottom of the lens, SAEA1R. It did not appear as though the section of vehicle was from the hit & run fatality accident; however, was taken in my possession and I later checked with Lt. Bushman. He also did not believe the pieces I had were from the veh. he was looking for.

KIRK told me that SYLVIA HYNEK had found the piece out by the end of the driveway at [redacted] CTH CR. I made contact with SYLVIA and she walked me out to the end of the driveway and pointed to the right corner as you are exiting the driveway. She informed me that in the snow is where she found the piece of head lamp housing and as we walked out to the end of the driveway, I also observed three other pieces of plastic lying just around the corner. The one section of plastic was silver in color with clear front, this piece matched up to the larger section of head lamp housing that SYLVIA had found. I also found two pieces of what appeared to be a signal light cover. One of the pieces having the letter "R" stamped in it. The two pieces match together and is it is a very good possibility they also go along with the larger section head lamp housing.

Again as indicated above, I checked with Lt. Bushman, and due to the fact the pieces looked newer, he did not believe they belong to the suspect veh. on the hit & run fatality. The veh. pieces that I received were taken to MTSO and property tagged and placed into the temporary evidence room at MTSO for safe keeping in ref. to the hit & run fatality just in case the pieces would be needed. At this time no further follow up will need to be done.

JJost *[Signature]* klf

45. IF COMPLAINANT DIFFERENT THEN CALLER, ENTER NAME, ADDRESS, D.O.B., TELEPHONE.

46. IF CODE O (OTHER) IS USED IN FIELD #39, EXPLAIN.

INCIDENT REPORT: NOTE: IF SECTION 22 ABOVE HAS NUMBER 4 CHECKED, DO NOT GO BEYOND THIS LINE WITHOUT RECORDS SECTION BEING ADVISED, OR NO RECORD ENTRIES WILL BE MADE BELOW THIS LINE.

PROPERTY VALUE	26. PROPERTY	A. CURRENCY	B. JEWELRY	C. FURS CLOTHING	D. VEHICLE (LOCAL)	E. OFFICE EQUIPMENT	F. RADIO, TV CAMERAS	G. FIREARMS	H. HOUSE-HOLD GOODS
	STOLEN	\$	\$	\$	\$	\$	\$	\$	\$
	RECOVERED	\$	\$	\$	\$	\$	\$	\$	\$
	26. PROPERTY	I. CONSUMABLES	J. LIVESTOCK	K. DRUGS	L. MARINE ITEMS	M. CONSTRUCTION ITEMS	N. LAWN AND GARDEN	O. SPORTING GOODS	P. MISC BICYCLE
	STOLEN	\$	\$	\$	\$	\$	\$	\$	\$
	RECOVERED	\$	\$	\$	\$	\$	\$	\$	\$

27. PROPERTY RECOVERED: LOCALLY ____ OTHER JURISDICTION ____ (INSERT O OR L)

PROPERTY ITEMIZATION	PROPERTY STOLEN/RECOVERED ITEMIZATION, USE THE FOLLOWING FORMAT				
	28. QUANTITY	29. ARTICLE NAME	30. BRAND NAME	31. SERIAL NUMBER	32. CODE
					S R <input type="checkbox"/> <input type="checkbox"/>
					S R <input type="checkbox"/> <input type="checkbox"/>
					S R <input type="checkbox"/> <input type="checkbox"/>
					S R <input type="checkbox"/> <input type="checkbox"/>

33. PROPERTY DAMAGE AMOUNT \$ _____

34. INSURANCE COMPANY _____

35. OFFICER ASSAULTED Y N 36. ARSON Y N 37. STRUCTURE CODE _____ 38. DAMAGE \$ _____

47. CIB NCIC OTHER BROADCAST	ENTERED	CANCELLED	48. TOTAL AMOUNT PROPERTY STOLEN \$ _____
	<input type="checkbox"/>	<input type="checkbox"/>	
	<input type="checkbox"/>	<input type="checkbox"/>	
			49. TOTAL AMOUNT PROPERTY RECOVERED \$ _____

50. IS REPORT CONTINUED? YES NO 51. CAUTION INDICATORS, ATLS ETC.

52. DATA PROCESS INFORMATION:

COMPUTER ENTERED DATE 10/21/99

MICROFILM INDEXED INITIAL KS

IS CASE CLASSIFICATION CORRECT? Y N
IF N HAS CORRECTION BEEN MADE? N

53. FILE APPROVAL
BY CK DATE 10/19/99

PROPERTY/EVIDENCE CONTROL

INVENTORY LOCATION A-20

1. INCIDENT <u>599-00434</u>	2. ITEM <u>CAR PARTS</u>	3. DATE <u>01/11/99</u>	4. <input type="checkbox"/> FELONY Release Date:	<input type="checkbox"/> MIS.	<input type="checkbox"/> PROPERTY
5. ITEM NAME	6. BRAND NAME	7. MODEL	8. SERIAL NO.		

9. OTHER DESCRIPTION OR IDENTIFYING MARKS: (ONE ITEM ONLY)
4 PLASTIC CAR PARTS: 2 Pcs. SIGNAL HOUSING (AMBER)
2 Pcs. HEADLAMP HOUSING

10. CITATION NOS.

11. TOWED VEHICLES
Abandoned Impounded Wrecker _____ Amount _____
Rel. Date _____ Auth. By _____

12. EMPLOYEE NO: 449
DATE REC:

13. CHAIN OF POSSESSION:		14. DATE	15. TIME	16. REASON FOR TRANSFER
FROM	<u>1024 CTH CR</u>	<u>01-15-99</u>	<u>1401 HRS</u>	<u>TAKEN INTO OFFICER'S</u>
TO	<u>JOST 449</u>	<u>"</u>	<u>"</u>	<u>POSSESSION</u>
FROM	<u>JOST 449</u>	<u>01-15-99</u>	<u>2010 HRS</u>	<u>PLACED INTO EVIDENCE</u>
TO	<u>TEMP. EVIDENCE PART 22</u>	<u>"</u>	<u>"</u>	
FROM	<u>TEMP. LOCKER 22</u>	<u>01-16-99</u>		
TO	<u>MTSD EVID. # A-20</u>		<u>0900</u>	<u>JML</u>
FROM				
TO				
FROM				
TO				
FROM				
TO				

PLACE YELLOW COPY WITH INCIDENT UPON PLACING IN EVIDENCE LOCKER

S99 N^o 00954 123011 1141211

4. INCIDENT ES/S99-00242			
5. INCIDENT LOCATION			
6. NAME - LAST - FIRST - MI		7. D.O.B.	
8. ADDRESS		9. TX-HOME	
11. CITY	STATE	ZIP	10. TX-BUSINESS
12. DETAILS REPORTS INFO ON HER VEH ON CR.			

995 1-31-99

14. REC'D	15. DISP	16. 10-23	17. 10-24
13. DAY			
SUN 1	THU 5		
MON 2	FRI 6		
TUE 3	SAT 7		
WED 4			

INCIDENT CARD		
18. ASSIGNED LT THORRINGTON		41316
P HERRMANN		4218
MISO		9219
NICHOLSON		AB14
19. REC. BY 436	20. DIS. BY 436	22. TYPE OF REPORT ① INCIDENT ② ACCIDENT ③ CITATION ④ NONE
21. HOW REC'D. ① 911 ② POLICE RADIO ③ PHONE ④ TTY ⑤ IN PERSON ⑥ ON VIEW ⑦ OFF. OFF DUTY ⑧ C.B. RADIO ⑨ OTHER		23. STATUS ① UNFOUNDED ② PNL ③ OTHER ④ CLEARED ⑤ EXCEPT CLEARED
21A. M.O.		24. DATE CLEARED 10/5/6/00
		25. OFFENSE TYPE ① ADULT <input type="checkbox"/> NA <input checked="" type="checkbox"/> ② JUVENILE <input type="checkbox"/> ③ UNKNOWN <input type="checkbox"/>

100

39. (CODE S-SUSPECT W-WITNESS V-VICTIM O-OTHER)						
CODE	40. NAME-LAST	FIRST	MI	41. D.O.B.	42. ADDRESS	43. TELEPHONE
O	COVER	DAVID	A		JOHNSTON DR MANITOWOC WI	

01-31-99 1930

I, Lt. Thorrrington was off duty when approached by the comp. ref. some information regarding the hit and run fatal accident. Comp. states he delivers newspapers normally at night and early morning hours. Since the accident the comp. has not seen the usual delivery van that delivers the Post Crescent newspaper. The vehicle is described as a chev van, older possibly black or tan. Comp. states that this vehicle was int he area every saturday and sunday prior to the accident. Comp. further staqted that he had seen the vehicle around the 2:00AM mark normally around the Manitowoc area.

The above info. was given to P. Herrmann verbally. Lt. Thorrrington *HT*

04-05-99: I, Det Nicholson contacted [redacted] of the Post Cresent. Delivery to Manitowoc County is by US Mail, no delivery by carrier. Unfounded. FRN/ *J*

45. IF COMPLAINANT DIFFERENT THEN CALLER, ENTER NAME, ADDRESS, D.O.B., TELEPHONE.

46. IF CODE O (OTHER) IS USED IN FIELD #39, EXPLAIN.

INCIDENT REPORT: NOTE: IF SECTION 22 ABOVE HAS NUMBER 4 CHECKED, DO NOT GO BEYOND THIS LINE WITHOUT RECORDS SECTION BEING ADVISED, OR NO RECORD ENTRIES WILL BE MADE BELOW THIS LINE.

PROPERTY VALUE	26. PROPERTY	A. CURRENCY	B. JEWELRY	C. FURS CLOTHING	D. VEHICLE (LOCAL)	E. OFFICE EQUIPMENT	F. RADIO, TV CAMERAS	G. FIREARMS	H. HOUSE-HOLD GOODS
	STOLEN	\$	\$	\$	\$	\$	\$	\$	\$
	RECOVERED	\$	\$	\$	\$	\$	\$	\$	\$
	26. PROPERTY	I. CONSUM-ABLES	J. LIVESTOCK	K. DRUGS	L. MARINE ITEMS	M. CONSTRUCTION ITEMS	N. LAWN AND GARDEN	O. SPORTING GOODS	P. MISC BICYCLE
	STOLEN	\$	\$	\$	\$	\$	\$	\$	\$
	RECOVERED	\$	\$	\$	\$	\$	\$	\$	\$

27. PROPERTY RECOVERED: LOCALLY _____ OTHER JURISDICTION _____ (INSERT O OR L)

PROPERTY ITEMIZATION	PROPERTY STOLEN/RECOVERED ITEMIZATION, USE THE FOLLOWING FORMAT				
	28. QUANTITY	29. ARTICLE NAME	30. BRAND NAME	31. SERIAL NUMBER	32. CODE
					S R <input type="checkbox"/> <input type="checkbox"/>
					S R <input type="checkbox"/> <input type="checkbox"/>
					S R <input type="checkbox"/> <input type="checkbox"/>
					S R <input type="checkbox"/> <input type="checkbox"/>

33. PROPERTY DAMAGE AMOUNT \$ _____ 34. INSURANCE COMPANY _____

35. OFFICER ASSAULTED Y N 36. ARSON Y N 37. STRUCTURE CODE _____ 38. DAMAGE \$ _____

47. CIB ENTERED CANCELLED
 NCIC
 OTHER BROADCAST

48. TOTAL AMOUNT PROPERTY STOLEN \$ _____

49. TOTAL AMOUNT PROPERTY RECOVERED \$ _____

50. IS REPORT CONTINUED? YES NO

51. CAUTION INDICATORS, ATLS ETC.

52. DATA PROCESS INFORMATION:

COMPUTER ENTERED DATE 15/17/00
 MICROFILM INDEXED INITIAL AS

53. FILE APPROVAL

IS CASE CLASSIFICATION CORRECT? Y N
 IF N HAS CORRECTION BEEN MADE? Y N

BY AS DATE 05/16/00

S99 NO 00884 16.310.11.110100.0

4. INCIDENT
CS/S99-00242

5. INCIDENT LOCATION
GREEN BAY

6. NAME- LAST-FIRST-MI
GBP D (OFFICER BICKETT) 1040

7. D.O.B.

8. ADDRESS

9. TX-HOME

11. CITY STATE ZIP

10. TX-BUSINESS

12. DETAILS
RECEIVED INFO, REGARDING POSSIBLE
VEH. + SUSPECT IN H+R FATAL.
SUSPECT ORLA BUKOWSKI, FRANK
K. M/W 08-23-54

INCIDENT CARD

18. ASSIGNED
LT. BUSHMAN 441
HERRMANN 428
929

19. REC. BY
936

20. DIS. BY

22. TYPE OF REPORT
① INCIDENT
2. ACCIDENT
3. CITATION
4. NONE

21. HOW REC'D.
1. 911
2. POLICE RADIO
③ PHONE
4. TTY
5. IN PERSON
6. ON VIEW
7. OFF. OFF DUTY
8. C.B. RADIO
9. OTHER

23. STATUS
1. UNFOUNDED
2. PNL
③ OTHER
4. CLEARED
5. EXCEPT CLEARED

24. DATE CLEARED
0308 99

25. OFFENSE TYPE
1. ADULT NA
2. JUVENILE
3. UNKNOWN

14. REC'D
15. DISP
16. 10-23
17. 10-24

13. DAY
SUN 1 THU 5
MON 2 FRI 6
TUE 3 SAT 7
WED 4

21A. M.O.

39. (CODE S-SUSPECT W-WITNESS V-VICTIM O-OTHER)						
CODE	40. NAME-LAST	FIRST	MI	41. D.O.B.	42. ADDRESS	43. TELEPHONE
O	ORLA-BUKOWSKI	FRANK	K		N Broadway St #25, Green Bay	54303
		175512				

01/28/99: I, Deputy P. Herrmann, along with Lt. M. Bushman met with GBP D Officer S. Bickett at GBP D reference this incident. Officer Bickett directed Lt. Bushman and me to an apartment complex located on Broadway St in the City of Green Bay where we were able to make contact with FRANK ORLA-BUKOWSKI.

I introduced myself to ORLA-BUKOWSKI as a police office from MTSO. I asked ORLA-BUKOWSKI if he would be willing to answer questions regarding his whereabouts and damage to his vehicle to which he stated yes. I advised ORLA-BUKOWSKI he was not under arrest and was free to leave at any time he wished to which he stated he understood.

ORLA-BUKOWSKI stated he works at the shelter at this address in the kitchen on the weekends beginning at 1800 hours and working until midnight. This was verified through the shelter's work schedule. I asked ORLA-BUKOWSKI if he has ever traveled to Manitowoc or the Manitowoc area within the recent past to which he stated no. ORLA-BUKOWSKI stated his Chevy Blazer received extensive front end damage as a result of an accident in Stiles, WI, back in October or November 1998.

I found ORLA-BUKOWSKI to be cooperative and consistent with his explanation of the damages and his whereabouts on the night in question as it relates to this incident. ORLA-BUKOWSKI and his vehicle do not appear to be involved in this hit and run fatality.

PHerrmann /bjc

45. IF COMPLAINANT DIFFERENT THEN CALLER, ENTER NAME, ADDRESS, D.O.B., TELEPHONE.

46. IF CODE O (OTHER) IS USED IN FIELD #39, EXPLAIN.

INCIDENT REPORT: NOTE: IF SECTION 22 ABOVE HAS NUMBER 4 CHECKED, DO NOT GO BEYOND THIS LINE WITHOUT RECORDS SECTION BEING ADVISED, OR NO RECORD ENTRIES WILL BE MADE BELOW THIS LINE.

PROPERTY VALUE	26. PROPERTY	A. CURRENCY	B. JEWELRY	C. FURS CLOTHING	D. VEHICLE (LOCAL)	E. OFFICE EQUIPMENT	F. RADIO, TV CAMERAS	G. FIREARMS	H. HOUSE-HOLD GOODS
	STOLEN	\$	\$	\$	\$	\$	\$	\$	\$
	RECOVERED	\$	\$	\$	\$	\$	\$	\$	\$
	26. PROPERTY	I. CONSUMABLES	J. LIVESTOCK	K. DRUGS	L. MARINE ITEMS	M. CONSTRUCTION ITEMS	N. LAWN AND GARDEN	O. SPORTING GOODS	P. MISC BICYCLE
	STOLEN	\$	\$	\$	\$	\$	\$	\$	\$
	RECOVERED	\$	\$	\$	\$	\$	\$	\$	\$

27. PROPERTY RECOVERED: LOCALLY _____ OTHER JURISDICTION _____ (INSERT O OR L)

PROPERTY ITEMIZATION	PROPERTY STOLEN/RECOVERED ITEMIZATION, USE THE FOLLOWING FORMAT				
	28. QUANTITY	29. ARTICLE NAME	30. BRAND NAME	31. SERIAL NUMBER	32. CODE
					S R <input type="checkbox"/> <input type="checkbox"/>
					S R <input type="checkbox"/> <input type="checkbox"/>
					S R <input type="checkbox"/> <input type="checkbox"/>
					S R <input type="checkbox"/> <input type="checkbox"/>
					S R <input type="checkbox"/> <input type="checkbox"/>

33. PROPERTY DAMAGE AMOUNT \$ _____ 34. INSURANCE COMPANY _____

35. OFFICER ASSAULTED Y N 36. ARSON Y N 37. STRUCTURE CODE _____ 38. DAMAGE \$ _____

47. CIB ENTERED CANCELLED
 NCIC
 OTHER BROADCAST

48. TOTAL AMOUNT PROPERTY STOLEN \$ _____

49. TOTAL AMOUNT PROPERTY RECOVERED \$ _____

50. IS REPORT CONTINUED? YES NO

51. CAUTION INDICATORS, ATLS ETC.

52. DATA PROCESS INFORMATION:

COMPUTER ENTERED DATE 3.8.99
 MICROFILM INDEXED INITIAL KS

53. FILE APPROVAL
 BY KS DATE 03.08.99

IS CASE CLASSIFICATION CORRECT? N
 IF N HAS CORRECTION BEEN MADE? Y N

MTSO # 599-00242

G.B.P.D. # 99-05009

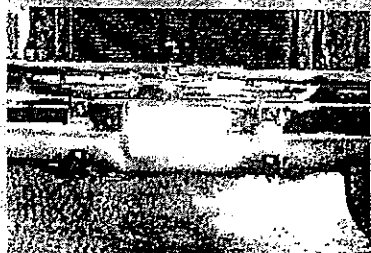

image02.jpg

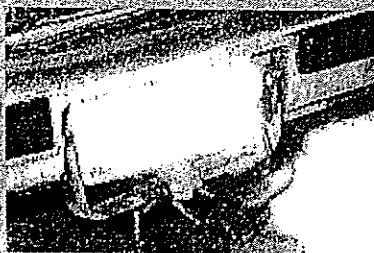

image03.jpg

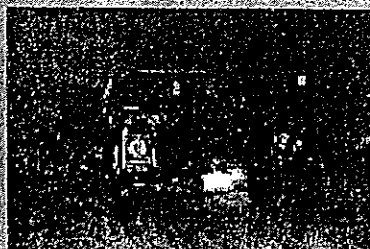

image04.jpg



image05.jpg



image06.jpg



image07.jpg



image08.jpg



image09.jpg



image10.jpg

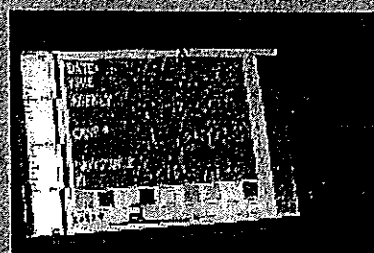

image01.jpg

S99 N^o 00896 16,310,11, 15,210,0,0

INCIDENT CARD

4. INCIDENT CS / S99-00242

5. INCIDENT LOCATION ON COLUMBUS b/t 10TH, 12TH

6. NAME LAST-FIRST-MI ANONY. (2) 7. D.O.B.

8. ADDRESS 9. TX-HOME

11. CITY STATE ZIP 10. TX-BUSINESS

12. DETAILS Rps. A dk blue chev front clip on trailer w/ white chev tk pulling trailer parked at above loc. HAS FRONT END DAMAGE

01-29-99 1411 1411 1505

18. ASSIGNED Lt. HERRMANN 41218 Jost 41419 929

19. REC. BY 938 20. DIS. BY 938 22. TYPE OF REPORT 1. INCIDENT 2. ACCIDENT 3. CITATION 4. NONE

21. HOW REC'D. 1. 911 2. POLICE RADIO 3. PHONE 4. TTY 5. IN PERSON 6. ON VIEW 7. OFF. OFF DUTY 8. C.B. RADIO 9. OTHER 23. STATUS 1. UNFOUNDED 2. PNL 3. OTHER 4. CLEARED 5. EXCEPT CLEARED

24. DATE CLEARED 103 P8 199 25. OFFENSE TYPE 1. ADULT 2. JUVENILE 3. UNKNOWN

14. REC'D 15. DISP 16. 10-23 17. 10-24 13. DAY SUN 1 THU 5 MON 2 FRI 6 TUE 3 SAT 7 WED 4

Table with 5 columns: CODE, 40. NAME-LAST, FIRST, MI, 41. D.O.B., 42. ADDRESS, 43. TELEPHONE. Row 1: 39. (CODE S-SUSPECT W-WITNESS V-VICTIM O-OTHER)

01-29-99 Deputy Jost checked above vehicle at [redacted] Columbus St. in Manitowoc. This would not be a match to H&R Veh. Incident can be closed out. 938/KB KB

45. IF COMPLAINANT DIFFERENT THEN CALLER, ENTER NAME, ADDRESS, D.O.B., TELEPHONE.

46. IF CODE O (OTHER) IS USED IN FIELD #39, EXPLAIN.

INCIDENT REPORT: NOTE: IF SECTION 22 ABOVE HAS NUMBER 4 CHECKED, DO NOT GO BEYOND THIS LINE WITHOUT RECORDS SECTION BEING ADVISED, OR NO RECORD ENTRIES WILL BE MADE BELOW THIS LINE.

PROPERTY VALUE	26. PROPERTY	A. CURRENCY	B. JEWELRY	C. FURS CLOTHING	D. VEHICLE (LOCAL)	E. OFFICE EQUIPMENT	F. RADIO, TV CAMERAS	G. FIREARMS	H. HOUSE-HOLD GOODS
	STOLEN	\$	\$	\$	\$	\$	\$	\$	\$
	RECOVERED	\$	\$	\$	\$	\$	\$	\$	\$
	26. PROPERTY	I. CONSUMABLES	J. LIVESTOCK	K. DRUGS	L. MARINE ITEMS	M. CONSTRUCTION ITEMS	N. LAWN AND GARDEN	O. SPORTING GOODS	P. MISC BICYCLE
	STOLEN	\$	\$	\$	\$	\$	\$	\$	\$
	RECOVERED	\$	\$	\$	\$	\$	\$	\$	\$

27. PROPERTY RECOVERED: LOCALLY ____ OTHER JURISDICTION ____ (INSERT O OR L)

PROPERTY ITEMIZATION	PROPERTY STOLEN/RECOVERED ITEMIZATION, USE THE FOLLOWING FORMAT				
	28. QUANTITY	29. ARTICLE NAME	30. BRAND NAME	31. SERIAL NUMBER	32. CODE
					S R <input type="checkbox"/> <input type="checkbox"/>
					S R <input type="checkbox"/> <input type="checkbox"/>
					S R <input type="checkbox"/> <input type="checkbox"/>
					S R <input type="checkbox"/> <input type="checkbox"/>
					S R <input type="checkbox"/> <input type="checkbox"/>

33. PROPERTY DAMAGE AMOUNT \$ _____

34. INSURANCE COMPANY _____

35. OFFICER ASSAULTED Y N

36. ARSON Y N

37. STRUCTURE CODE _____

38. DAMAGE \$ _____

47. CIB
NCIC
OTHER BROADCAST

ENTERED	CANCELLED
<input type="checkbox"/>	<input type="checkbox"/>
<input type="checkbox"/>	<input type="checkbox"/>
<input type="checkbox"/>	<input type="checkbox"/>

48. TOTAL AMOUNT PROPERTY STOLEN \$ _____

49. TOTAL AMOUNT PROPERTY RECOVERED \$ _____

50. IS REPORT CONTINUED? YES NO

51. CAUTION INDICATORS, ATLS ETC.

52. DATA PROCESS INFORMATION:

COMPUTER ENTERED DATE 13, 8, 99
MICROFILM INDEXED INITIAL AS

IS CASE CLASSIFICATION CORRECT?
IF N HAS CORRECTION BEEN MADE? Y N

53. FILE APPROVAL

BY R DATE 03/08/99

599 N^o 0089 / 16.310.11 | 1531000

IDENT **CS** | **S99-00242**

5. INCIDENT LOCATION **12TH St. , Two Rivers**

6. NAME - LAST - FIRST - MI **ANONY.** 7. D.O.B.

8. ADDRESS **(A)** 9. TX-HOME

11. CITY STATE ZIP 10. TX-BUSINESS

12. DETAILS
Rpts. CHW BLAZER LP# RCY 057
A BLK w/ GRAY sides w/ grill
DAMAGE + PASSENGER side DAMAGE
Hoods popped up.

01-29-99 1440 1511

14. REC'D	15. DISP	16. 10-23	17. 10-24
13. DAY			
SUN 1	THU 5		
MON 2	FRI 6		
TUE 3	SAT 7		
WED 4			

INCIDENT CARD

18. ASSIGNED **MTSO** **91219**

19. REC. BY **938** 20. DIS. BY

21. HOW REC'D.
 1. 911
 2. POLICE RADIO
 3. PHONE
 4. TTY
 5. IN PERSON
 6. ON VIEW
 7. OFF. OFF DUTY
 8. C.B. RADIO
 9. OTHER

22. TYPE OF REPORT
 1. INCIDENT
 2. ACCIDENT
 3. CITATION
 4. NONE

23. STATUS
 1. UNFOUNDED
 2. PNL
 3. OTHER
 4. CLEARED
 5. EXCEPT CLEARED

24. DATE CLEARED **03 08 99**

25. OFFENSE TYPE
 1. ADULT NA
 2. JUVENILE
 3. UNKNOWN

39. (CODE S-SUSPECT W-WITNESS V-VICTIM O-OTHER)

CODE	40. NAME - LAST	FIRST	MI	41. D.O.B.	42. ADDRESS	43. TELEPHONE

01-29-99 Officer Keery checked this veh. There is not enough damage to grill and head-lights do not make the suspect H&R veh. This incident can be closed. 938/KB

PP 4-5

45. IF COMPLAINANT DIFFERENT THEN CALLER, ENTER NAME, ADDRESS, D.O.B., TELEPHONE.

46. IF CODE O (OTHER) IS USED IN FIELD #39, EXPLAIN.

INCIDENT REPORT: NOTE: IF SECTION 22 ABOVE HAS NUMBER 4 CHECKED, DO NOT GO BEYOND THIS LINE WITHOUT RECORDS SECTION BEING ADVISED, OR NO RECORD ENTRIES WILL BE MADE BELOW THIS LINE.

PROPERTY VALUE	26. PROPERTY	A. CURRENCY	B. JEWELRY	C. FURS CLOTHING	D. VEHICLE (LOCAL)	E. OFFICE EQUIPMENT	F. RADIO, TV CAMERAS	G. FIREARMS	H. HOUSE-HOLD GOODS
	STOLEN	\$	\$	\$	\$	\$	\$	\$	\$
	RECOVERED	\$	\$	\$	\$	\$	\$	\$	\$
	26. PROPERTY	I. CONSUM-ABLES	J. LIVESTOCK	K. DRUGS	L. MARINE ITEMS	M. CONSTRUCTION ITEMS	N. LAWN AND GARDEN	O. SPORTING GOODS	P. MISC BICYCLE
STOLEN	\$	\$	\$	\$	\$	\$	\$	\$	
RECOVERED	\$	\$	\$	\$	\$	\$	\$	\$	

27. PROPERTY RECOVERED: LOCALLY _____ OTHER JURISDICTION _____ (INSERT O OR L)

PROPERTY ITEMIZATION	PROPERTY STOLEN/RECOVERED ITEMIZATION, USE THE FOLLOWING FORMAT				
	28. QUANTITY	29. ARTICLE NAME	30. BRAND NAME	31. SERIAL NUMBER	32. CODE
					S R <input type="checkbox"/> <input type="checkbox"/>
					S R <input type="checkbox"/> <input type="checkbox"/>
					S R <input type="checkbox"/> <input type="checkbox"/>
					S R <input type="checkbox"/> <input type="checkbox"/>

33. PROPERTY DAMAGE AMOUNT \$ _____

34. INSURANCE COMPANY _____

35. OFFICER ASSAULTED Y N 36. ARSON Y N 37. STRUCTURE CODE _____ 38. DAMAGE \$ _____

47. CIB ENTERED CANCELLED
 NCIC
 OTHER BROADCAST

48. TOTAL AMOUNT PROPERTY STOLEN \$ _____

49. TOTAL AMOUNT PROPERTY RECOVERED \$ _____

50. IS REPORT CONTINUED? YES NO

51. CAUTION INDICATORS, ATLS ETC.

52. DATA PROCESS INFORMATION:

COMPUTER ENTERED DATE 3.8.99
 MICROFILM INDEXED INITIAL AS

53. FILE APPROVAL

IS CASE CLASSIFICATION CORRECT? N
 IF N HAS CORRECTION BEEN MADE? N

BY [Signature] DATE 03.08.99

SA9-00906 16310.11 152000

INCIDENT CARD

4. INCIDENT
CSI SA9-00242

5. INCIDENT LOCATION
Cth CR

6. NAME - LAST - FIRST - MI
Anonymous (2)

7. D.O.B.

8. ADDRESS

9. TX-HOME

10. TX-BUSINESS

11. CITY STATE ZIP

12. DETAILS
Tobey or Trevor Anhaet working
on Gray Suburban w/ front end
damage @ [redacted] N Cth (A).

1-29-99 2230

14. REC'D.	15. DISP	16. 10-23	17. 10-24
13. DAY			
SUN 1	THU 5		
MON 2	FRI 6		
TUE 3	SAT 7		
WED 4			

18. ASSIGNED
MTPD
929
Glaeser 417

19. REC. BY
935

20. DIS. BY
933

21. HOW REC'D.
1. 911
2. POLICE RADIO
3. PHONE
4. TTY
5. IN PERSON
6. ON VIEW
7. OFF. OFF DUTY
8. C.B. RADIO
9. OTHER

22. TYPE OF REPORT
1. INCIDENT
2. ACCIDENT
3. CITATION
4. NONE

23. STATUS
1. UNFOUNDED
2. PNL
3. OTHER
4. CLEARED
5. EXCEPT CLEARED

24. DATE CLEARED
08 08 99

25. OFFENSE TYPE
1. ADULT NA
2. JUVENILE
3. UNKNOWN

39. (CODE S-SUSPECT W-WITNESS V-VICTIM O-OTHER)					42. ADDRESS	43. TELEPHONE
CODE	40. NAME-LAST	FIRST	MI	41. D.O.B.		

01-29-99 MTPD officer Traurig (763) checked resid, no vehs seen, however garage door closed, unable to check if veh's inside garage. 933/mb

02/18/99: I, Deputy E. Glaeser, pulled this report from the file as I did recognize the suspect name. I have conducted 2 interviews with this party prior to this complaint. He can be eliminated as a suspect.

No further action taken. EJGlaeser /bjc

45. IF COMPLAINANT DIFFERENT THEN CALLER, ENTER NAME, ADDRESS, D.O.B., TELEPHONE.

46. IF CODE O (OTHER) IS USED IN FIELD #39, EXPLAIN.

INCIDENT REPORT: NOTE: IF SECTION 22 ABOVE HAS NUMBER 4 CHECKED, DO NOT GO BEYOND THIS LINE WITHOUT RECORDS SECTION BEING ADVISED, OR NO RECORD ENTRIES WILL BE MADE BELOW THIS LINE.

PROPERTY VALUE	26. PROPERTY	A. CURRENCY	B. JEWELRY	C. FURS CLOTHING	D. VEHICLE (LOCAL)	E. OFFICE EQUIPMENT	F. RADIO, TV CAMERAS	G. FIREARMS	H. HOUSE-HOLD GOODS
	STOLEN	\$	\$	\$	\$	\$	\$	\$	\$
	RECOVERED	\$	\$	\$	\$	\$	\$	\$	\$
	26. PROPERTY	I. CONSUMABLES	J. LIVESTOCK	K. DRUGS	L. MARINE ITEMS	M. CONSTRUCTION ITEMS	N. LAWN AND GARDEN	O. SPORTING GOODS	P. MISC BICYCLE
	STOLEN	\$	\$	\$	\$	\$	\$	\$	\$
	RECOVERED	\$	\$	\$	\$	\$	\$	\$	\$

27. PROPERTY RECOVERED: LOCALLY _____ OTHER JURISDICTION _____ (INSERT O OR L)

PROPERTY ITEMIZATION	PROPERTY STOLEN/RECOVERED ITEMIZATION, USE THE FOLLOWING FORMAT			31. SERIAL NUMBER	32. CODE
	28. QUANTITY	29. ARTICLE NAME	30. BRAND NAME		
					S <input type="checkbox"/> R <input type="checkbox"/>
					S <input type="checkbox"/> R <input type="checkbox"/>
					S <input type="checkbox"/> R <input type="checkbox"/>
					S <input type="checkbox"/> R <input type="checkbox"/>
					S <input type="checkbox"/> F <input type="checkbox"/>
					S <input type="checkbox"/> F <input type="checkbox"/>

33. PROPERTY DAMAGE AMOUNT \$ _____ 34. INSURANCE COMPANY _____

35. OFFICER ASSAULTED Y N 36. ARSON Y N 37. STRUCTURE CODE _____ 38. DAMAGE \$ _____

47. CIB ENTERED CANCELLED
 NCIC
 OTHER BROADCAST

48. TOTAL AMOUNT PROPERTY STOLEN \$ _____

49. TOTAL AMOUNT PROPERTY RECOVERED \$ _____

50. IS REPORT CONTINUED? YES NO

51. CAUTION INDICATORS, ATLS ETC.

52. DATA PROCESS INFORMATION:

COMPUTER ENTERED DATE 10/8/99
 MICROFILM INDEXED INITIAL AS

53. FILE APPROVAL
 BY RE DATE 10/8/99

IS CASE CLASSIFICATION CORRECT? Y N
 IF N HAS CORRECTION BEEN MADE? Y N

S99 N^o 00977 16310.11 152400

4. INCIDENT CS-S99-00242

5. INCIDENT LOCATION [REDACTED] Cty Hwy LS

6. NAME- LAST-FIRST-MI [REDACTED] 89122 7. D.O.B. [REDACTED]

8. ADDRESS [REDACTED] 9. TX-HOME [REDACTED]

11. CITY [REDACTED] STATE ZIP [REDACTED] 10. TX-BUSINESS [REDACTED]

12. DETAILS
 Caller has a customer Joseph Popp D.O.B. [REDACTED] w/a veh. he suspects may be involved plate 901162F.

1020

14. REC'D	15. DISP	16. 10-23	17. 10-24
13. DAY			
SUN 1	THU 5		
MON 2	FRI 6		
TUE 3	SAT 7		
WED 4			

INCIDENT CARD

18. ASSIGNED 929
 Glaeser 4117

19. REC. BY 944 20. DIS. BY

21. HOW REC'D.
 1. 911
 2. POLICE RADIO
 3. PHONE
 4. TTY
 5. IN PERSON
 6. ON VIEW
 7. OFF. OFF DUTY
 8. C.B. RADIO
 9. OTHER

22. TYPE OF REPORT
 1. INCIDENT
 2. ACCIDENT
 3. CITATION
 4. NONE

23. STATUS
 1. UNFOUNDED
 2. PNL
 3. OTHER
 4. CLEARED
 5. EXCEPT CLEARED

24. DATE CLEARED 103108/99

25. OFFENSE TYPE
 1. ADULT NA
 2. JUVENILE
 3. UNKNOWN

39. (CODE S-SUSPECT W-WITNESS V-VICTIM O-OTHER)

CODE	40. NAME-LAST	FIRST	MI	41. D.O.B.	42. ADDRESS	43. TELEPHONE
S	POPP JOSEPH H	9074		[REDACTED]	CIH IS Manitowoc	[REDACTED]

01/30/99 @ 1000 Hrs I, Deputy E. Glaeser investigated this crimestoppers report of a vehicle owned by JOE POPP as having right front damage and possible Hit and Run connection. The vehicle was a Blue 1983 Chev pick up displaying WI Farm plate # 90162F. The vehicle had old right front quarterpanel, fender damage but the grill did not match our suspect from the H&R. POPP's truck can be eliminated as suspect.

EJG

ETG

PP 5280

45. IF COMPLAINANT DIFFERENT THEN CALLER, ENTER NAME, ADDRESS, D.O.B., TELEPHONE.

46. IF CODE O (OTHER) IS USED IN FIELD #39, EXPLAIN.

INCIDENT REPORT: NOTE: IF SECTION 22 ABOVE HAS NUMBER 4 CHECKED, DO NOT GO BEYOND THIS LINE WITHOUT RECORDS SECTION BEING ADVISED, OR NO RECORD ENTRIES WILL BE MADE BELOW THIS LINE.

PROPERTY VALUE	26. PROPERTY	A. CURRENCY	B. JEWELRY	C. FURS CLOTHING	D. VEHICLE (LOCAL)	E. OFFICE EQUIPMENT	F. RADIO, TV CAMERAS	G. FIREARMS	H. HOUSE-HOLD GOODS
	STOLEN	\$	\$	\$	\$	\$	\$	\$	\$
	RECOVERED	\$	\$	\$	\$	\$	\$	\$	\$
	26. PROPERTY	I. CONSUM-ABLES	J. LIVESTOCK	K. DRUGS	L. MARINE ITEMS	M. CONSTRUCTION ITEMS	N. LAWN AND GARDEN	O. SPORTING GOODS	P. MISC BICYCLE
	STOLEN	\$	\$	\$	\$	\$	\$	\$	\$
	RECOVERED	\$	\$	\$	\$	\$	\$	\$	\$

27. PROPERTY RECOVERED: LOCALLY _____ OTHER JURISDICTION _____ (INSERT O OR L)

PROPERTY ITEMIZATION	PROPERTY STOLEN/RECOVERED ITEMIZATION, USE THE FOLLOWING FORMAT				
	28. QUANTITY	29. ARTICLE NAME	30. BRAND NAME	31. SERIAL NUMBER	32. CODE
					S R <input type="checkbox"/> <input type="checkbox"/>
					S R <input type="checkbox"/> <input type="checkbox"/>
					S R <input type="checkbox"/> <input type="checkbox"/>
					S R <input type="checkbox"/> <input type="checkbox"/>
					S R <input type="checkbox"/> <input type="checkbox"/>

33. PROPERTY DAMAGE AMOUNT \$ _____ 34. INSURANCE COMPANY _____

35. OFFICER ASSAULTED Y N 36. ARSON Y N 37. STRUCTURE CODE _____ 38. DAMAGE \$ _____

47. CIB ENTERED CANCELLED
 NCIC
 OTHER BROADCAST

48. TOTAL AMOUNT PROPERTY STOLEN \$ _____

49. TOTAL AMOUNT PROPERTY RECOVERED \$ _____

50. IS REPORT CONTINUED? YES NO

51. CAUTION INDICATORS, ATLS ETC.

52. DATA PROCESS INFORMATION:

COMPUTER ENTERED DATE 13.8.99
 MICROFILM INDEXED INITIAL RS

53. FILE APPROVAL

BY KP DATE 03.08.99

IS CASE CLASSIFICATION CORRECT? N
 IF N HAS CORRECTION BEEN MADE? N

S99 No 00918 16301 152000

4. INCIDENT CS-599-0242

5. INCIDENT LOCATION Home toward Meadow Links rt. side

6. NAME- LAST-FIRST-MI [REDACTED] 106990 7. D.O.B. [REDACTED]

8. ADDRESS [REDACTED] 9. TX-HOME [REDACTED]

11. CITY [REDACTED] STATE [REDACTED] ZIP [REDACTED] 10. TX-BUSINESS [REDACTED]

12. DETAILS
Saw a 86 chevy w/ grill damage for sale at above loc plate # AT80427

1120 01309

INCIDENT CARD

18. ASSIGNED
Bushman R29
4.4.1

19. REC. BY 944 20. DIS. BY

21. HOW REC'D.
1. 911
2. POLICE RADIO
3. PHONE
4. TTY
5. IN PERSON
6. ON VIEW
7. OFF. OFF DUTY
8. C.B. RADIO
9. OTHER

22. TYPE OF REPORT
1. INCIDENT
2. ACCIDENT
3. CITATION
4. NONE

23. STATUS
1. UNFOUNDED
2. PNL
3. OTHER
4. CLEARED
5. EXCEPT CLEARED

24. DATE CLEARED 03/08/99

25. OFFENSE TYPE
1. ADULT NA
2. JUVENILE
3. UNKNOWN

21A. M.O.

14. REC'D	15. DISP	16. 10-23	17. 10-24
13. DAY			
SUN 1	THU 5		
MON 2	FRI 6		
TUE 3	SAT 7		
WED 4			

39. (CODE S-SUSPECT W-WITNESS V-VICTIM O-OTHER)						
CODE	40. NAME-LAST	FIRST	MI	41. D.O.B.	42. ADDRESS	43. TELEPHONE

01/30/99 This vehicle was standing on the street with a FOR SALE sign attached. It was checked several times. IT has oversize tires and a custom rusted grille, dk blue in color, not the vehicle we are looking for, close. M.J. Bushman

PP 5385

45. IF COMPLAINANT DIFFERENT THEN CALLER, ENTER NAME, ADDRESS, D.O.B., TELEPHONE.

46. IF CODE O (OTHER) IS USED IN FIELD #39, EXPLAIN.

INCIDENT REPORT: NOTE: IF SECTION 22 ABOVE HAS NUMBER 4 CHECKED, DO NOT GO BEYOND THIS LINE WITHOUT RECORDS SECTION BEING ADVISED, OR NO RECORD ENTRIES WILL BE MADE BELOW THIS LINE.

PROPERTY VALUE	26. PROPERTY	A. CURRENCY	B. JEWELRY	C. FURS CLOTHING	D. VEHICLE (LOCAL)	E. OFFICE EQUIPMENT	F. RADIO, TV CAMERAS	G. FIREARMS	H. HOUSE-HOLD GOODS
	STOLEN	\$	\$	\$	\$	\$	\$	\$	\$
	RECOVERED	\$	\$	\$	\$	\$	\$	\$	\$
	26. PROPERTY	I. CONSUMABLES	J. LIVESTOCK	K. DRUGS	L. MARINE ITEMS	M. CONSTRUCTION ITEMS	N. LAWN AND GARDEN	O. SPORTING GOODS	P. MISC BICYCLE
	STOLEN	\$	\$	\$	\$	\$	\$	\$	\$
	RECOVERED	\$	\$	\$	\$	\$	\$	\$	\$

27. PROPERTY RECOVERED: LOCALLY _____ OTHER JURISDICTION _____ (INSERT O OR L)

PROPERTY ITEMIZATION	PROPERTY STOLEN/RECOVERED ITEMIZATION, USE THE FOLLOWING FORMAT				
	28. QUANTITY	29. ARTICLE NAME	30. BRAND NAME	31. SERIAL NUMBER	32. CODE
					S R <input type="checkbox"/> <input type="checkbox"/>
					S R <input type="checkbox"/> <input type="checkbox"/>
					S R <input type="checkbox"/> <input type="checkbox"/>
					S R <input type="checkbox"/> <input type="checkbox"/>
					S R <input type="checkbox"/> <input type="checkbox"/>

33. PROPERTY DAMAGE AMOUNT \$ _____

34. INSURANCE COMPANY _____

35. OFFICER ASSAULTED Y N

36. ARSON Y N

37. STRUCTURE CODE _____ 38. DAMAGE \$ _____

47. CIB ENTERED CANCELLED
 NCIC
 OTHER BROADCAST

48. TOTAL AMOUNT PROPERTY STOLEN \$ _____

49. TOTAL AMOUNT PROPERTY RECOVERED \$ _____

50. IS REPORT CONTINUED? YES NO

51. CAUTION INDICATORS, ATLS ETC.

52. DATA PROCESS INFORMATION:

COMPUTER ENTERED DATE 3/8/99
 MICROFILM INDEXED INITIAL AS

53. FILE APPROVAL

IS CASE CLASSIFICATION CORRECT? Y N
 IF N HAS CORRECTION BEEN MADE? Y N

BY IS DATE 030899

S99 No 00925 5.71181 110000

INCIDENT CARD

4. INCIDENT Receive Info

5. INCIDENT LOCATION Oconto County

6. NAME - LAST-FIRST-MI [REDACTED] 7. D.O.B. [REDACTED]

8. ADDRESS [REDACTED] 9. TX-HOME [REDACTED]

11. CITY [REDACTED] STATE [REDACTED] ZIP [REDACTED] 10. TX-BUSINESS [REDACTED]

12. DETAILS In Oconto County, approx. 1500 hrs. today, caller saw a gray pick up truck southbound on Hwy 4/141.

1857

01/30/99

14. REC'D	15. DISP	16. 10-23	17. 10-24

13. DAY
SUN 1 THU 5
MON 2 FRI 6
TUE 3 SAT 7
WED 4

18. ASSIGNED Info 9181

19. REC. BY 925 20. DIS. BY

21. HOW REC'D
1. 911
2. POLICE RADIO
3. PHONE
4. TTY
5. IN PERSON
6. ON VIEW
7. OFF. OFF DUTY
8. C.B. RADIO
9. OTHER

22. TYPE OF REPORT
1. INCIDENT
2. ACCIDENT
3. CITATION
4. NONE

23. STATUS
1. UNFOUNDED
2. PNL
3. OTHER
4. CLEARED
5. EXCEPT CLEARED

24. DATE CLEARED 03 08 99

25. OFFENSE TYPE
1. ADULT NA
2. JUVENILE
3. UNKNOWN

39. (CODE S-SUSPECT W-WITNESS V-VICTIM O-OTHER)

CODE	40. NAME-LAST	FIRST	MI	41. D.O.B.	42. ADDRESS	43. TELEPHONE

Vehicle described as solid (light) gray in color, either a Chev or GMC product with the left (driver's side) half of the grill damaged, vehicle was in good shape, no primer, operator was a youner female with blonde hair. Complainant did not obtain license plate. SE SE

01/30/99 Unable to locate, information did not provide registration. Close M.J. Bushman

PP 87 50

45. IF COMPLAINANT DIFFERENT THEN CALLER, ENTER NAME, ADDRESS, D.O.B., TELEPHONE.

46. IF CODE O (OTHER) IS USED IN FIELD #39, EXPLAIN.

INCIDENT REPORT: NOTE: IF SECTION 22 ABOVE HAS NUMBER 4 CHECKED, DO NOT GO BEYOND THIS LINE WITHOUT RECORDS SECTION BEING ADVISED, OR NO RECORD ENTRIES WILL BE MADE BELOW THIS LINE.

PROPERTY VALUE	26. PROPERTY	A. CURRENCY	B. JEWELRY	C. FURS CLOTHING	D. VEHICLE (LOCAL)	E. OFFICE EQUIPMENT	F. RADIO, TV CAMERAS	G. FIREARMS	H. HOUSE-HOLD GOODS
	STOLEN	\$	\$	\$	\$	\$	\$	\$	\$
	RECOVERED	\$	\$	\$	\$	\$	\$	\$	\$
	26. PROPERTY	I. CONSUMABLES	J. LIVESTOCK	K. DRUGS	L. MARINE ITEMS	M. CONSTRUCTION ITEMS	N. LAWN AND GARDEN	O. SPORTING GOODS	P. MISC BICYCLE
	STOLEN	\$	\$	\$	\$	\$	\$	\$	\$
	RECOVERED	\$	\$	\$	\$	\$	\$	\$	\$

27. PROPERTY RECOVERED: LOCALLY _____ OTHER JURISDICTION _____ (INSERT O OR L)

PROPERTY ITEMIZATION	PROPERTY STOLEN/RECOVERED ITEMIZATION, USE THE FOLLOWING FORMAT				
	28. QUANTITY	29. ARTICLE NAME	30. BRAND NAME	31. SERIAL NUMBER	32. CODE
					S R <input type="checkbox"/> <input type="checkbox"/>
					S R <input type="checkbox"/> <input type="checkbox"/>
					S R <input type="checkbox"/> <input type="checkbox"/>
					S R <input type="checkbox"/> <input type="checkbox"/>
					S R <input type="checkbox"/> <input type="checkbox"/>

33. PROPERTY DAMAGE AMOUNT \$ _____ 34. INSURANCE COMPANY _____

35. OFFICER ASSAULTED Y N 36. ARSON Y N 37. STRUCTURE CODE _____ 38. DAMAGE \$ _____

47. CIB ENTERED CANCELLED
 NCIC
 OTHER BROADCAST

48. TOTAL AMOUNT PROPERTY STOLEN \$ _____

49. TOTAL AMOUNT PROPERTY RECOVERED \$ _____

50. IS REPORT CONTINUED? YES NO

51. CAUTION INDICATORS, ATLS ETC.

52. DATA PROCESS INFORMATION:

COMPUTER ENTERED DATE 3.8.99
 MICROFILM INDEXED INITIAL KS

53. FILE APPROVAL

IS CASE CLASSIFICATION CORRECT? Y N
 IF N HAS CORRECTION BEEN MADE? N

BY KR DATE 03.08.99

599 No 00945 57181 B21000

4. INCIDENT Receive Info

5. INCIDENT LOCATION Madison, Manitowoc

6. NAME - LAST - FIRST - MI MTPD (#572) 7. D.O.B.

8. ADDRESS 9. TX-HOME

11. CITY STATE ZIP 10. TX-BUSINESS

12. DETAILS MTPD officer noticed

a truck with RP #

"CA23143" with right

front damage parked at

above location.

1400
1406
01/31/99
JOST

INCIDENT CARD

18. ASSIGNED Jost 449

19. REC. BY 925 20. DIS. BY 925 22. TYPE OF REPORT
① INCIDENT
② ACCIDENT
③ CITATION
④ NONE

21. HOW REC'D.
1. 911
2. POLICE RADIO
3. PHONE
4. TTY
⑤ IN PERSON
6. ON VIEW
7. OFF. OFF DUTY
8. C.B. RADIO
9. OTHER

23. STATUS
1. UNFOUNDED
2. PNL
③ OTHER
4. CLEARED
5. EXCEPT CLEARED
24. DATE CLEARED 08 08 99
25. OFFENSE TYPE
1. ADULT NA
2. JUVENILE
3. UNKNOWN

13. DAY
SUN 1 THU 5
MON 2 FRI 6
TUE 3 SAT 7
WED 4

39. (CODE S-SUSPECT W-WITNESS V-VICTIM O-OTHER)						
CODE	40. NAME-LAST	FIRST	MI	41. D.O.B.	42. ADDRESS	43. TELEPHONE

On 01-31-99 I, Deputy Jost, checked the above vehicle however it does not match the description of our suspect vehicle. Jost JMJ

PPS 8/10

45. IF COMPLAINANT DIFFERENT THEN CALLER, ENTER NAME, ADDRESS, D.O.B., TELEPHONE.

46. IF CODE O (OTHER) IS USED IN FIELD #39, EXPLAIN.

INCIDENT REPORT: NOTE: IF SECTION 22 ABOVE HAS NUMBER 4 CHECKED, DO NOT GO BEYOND THIS LINE WITHOUT RECORDS SECTION BEING ADVISED, OR NO RECORD ENTRIES WILL BE MADE BELOW THIS LINE.

PROPERTY VALUE	26. PROPERTY	A. CURRENCY	B. JEWELRY	C. FURS CLOTHING	D. VEHICLE (LOCAL)	E. OFFICE EQUIPMENT	F. RADIO, TV CAMERAS	G. FIREARMS	H. HOUSE-HOLD GOODS
	STOLEN	\$	\$	\$	\$	\$	\$	\$	\$
	RECOVERED	\$	\$	\$	\$	\$	\$	\$	\$
	26. PROPERTY	I. CONSUM-ABLES	J. LIVESTOCK	K. DRUGS	L. MARINE ITEMS	M. CONSTRUCTION ITEMS	N. LAWN AND GARDEN	O. SPORTING GOODS	P. MISC BICYCLE
	STOLEN	\$	\$	\$	\$	\$	\$	\$	\$
	RECOVERED	\$	\$	\$	\$	\$	\$	\$	\$

27. PROPERTY RECOVERED: LOCALLY _____ OTHER JURISDICTION _____ (INSERT O OR L)

PROPERTY ITEMIZATION	PROPERTY STOLEN/RECOVERED ITEMIZATION, USE THE FOLLOWING FORMAT				
	28. QUANTITY	29. ARTICLE NAME	30. BRAND NAME	31. SERIAL NUMBER	32. CODE
					S R <input type="checkbox"/> <input type="checkbox"/>
					S R <input type="checkbox"/> <input type="checkbox"/>
					S R <input type="checkbox"/> <input type="checkbox"/>
					S R <input type="checkbox"/> <input type="checkbox"/>
					S R <input type="checkbox"/> <input type="checkbox"/>

33. PROPERTY DAMAGE AMOUNT \$ _____

34. INSURANCE COMPANY _____

35. OFFICER ASSAULTED Y N

36. ARSON Y N

37. STRUCTURE CODE _____

38. DAMAGE \$ _____

47. CIB ENTERED CANCELLED
 NCIC ENTERED CANCELLED
 OTHER BROADCAST ENTERED CANCELLED

48. TOTAL AMOUNT PROPERTY STOLEN \$ _____

49. TOTAL AMOUNT PROPERTY RECOVERED \$ _____

50. IS REPORT CONTINUED? YES NO

51. CAUTION INDICATORS, ATLS ETC.

52. DATA PROCESS INFORMATION:
 COMPUTER ENTERED DATE 3.8.99
 MICROFILM INDEXED INITIAL KS
 IS CASE CLASSIFICATION CORRECT? Y N
 IF N HAS CORRECTION BEEN MADE? Y N

53. FILE APPROVAL
 BY R DATE 030899

S99 No 00433 10,310,11, 1,410,00

4. INCIDENT CS / S99-00242

5. INCIDENT LOCATION [REDACTED]

6. NAME- LAST-FIRST-MI ANONY. (2) 7. D.O.B. [REDACTED]

8. ADDRESS [REDACTED] 9. TX-HOME [REDACTED]

11. CITY STATE ZIP 10. TX-BUSINESS [REDACTED]

12. DETAILS
Rpts. [REDACTED] HEARD A RUMOR AT LHS ; THAT A MALE WHO LIVES AT ABOVE LOC. HAS BEEN GONE SINCE THE FATAL H OR

MANITOWOC COUNTY SHERIFF
INCIDENT CARD

18. ASSIGNED
BUSHMAN MTSO 924

19. REC. BY 938 20. DIS. BY [REDACTED]

22. TYPE OF REPORT
 1. INCIDENT
 2. ACCIDENT
 3. CITATION
 4. NONE

21. HOW REC'D.
 1. 911
 2. POLICE RADIO
 3. PHONE
 4. TTY
 5. IN PERSON
 6. ON VIEW
 7. OFF. OFF DUTY
 8. C.B. RADIO
 9. OTHER

23. STATUS
 1. UNFOUNDED
 2. PNL
 3. OTHER
 4. CLEARED
 5. EXCEPT CLEARED

24. DATE CLEARED 10/12/99

25. OFFENSE TYPE
 1. ADULT NA
 2. JUVENILE
 3. UNKNOWN

14. REC'D	15. DISP	16. 10-23	17. 10-24
13. DAY			
SUN 1	THU 5		
MON 2	FRI 6		
TUE 3	SAT 7		
WED 4			

39. (CODE S-SUSPECT W-WITNESS V-VICTIM O-OTHER)				41. D.O.B.		42. ADDRESS		43. TELEPHONE
CODE	40. NAME-LAST	FIRST	MI					
0	[REDACTED]	[REDACTED]	[REDACTED]	[REDACTED]	[REDACTED]	[REDACTED]	[REDACTED]	[REDACTED]
0	KOPE	DENNIS	M	[REDACTED]	[REDACTED]	Clover Rd, Manitowoc	[REDACTED]	[REDACTED]

01-15-99 con't... and may be an alcoholic. This person may be a neighbor of last name, [REDACTED] who resides in a brick house. Would drive a silver pick-up. 938/KB KB

01/16/99 @ 2100 Hrs.: I, Lt. M. Bushman, made contact with [REDACTED] and his wife at his residence at [REDACTED], Manitowoc. This anonymous Crime Stopper complaint was read to him. The complaint stated that [REDACTED] heard a rumor at LINCOLN HIGH SCHOOL that a male who lives at the above location (Clover Rd, between S 26th St and CTH CR) has been gone since the fatal hit and run and may be an alcoholic. This person may be a neighbor of the last name [REDACTED] who resides in a brick house. This person would drive a silver pickup truck. [REDACTED] and his wife live in a brick house, and they do live between S 26th St and CTH CR. They were unable to provide me with any information that would match the description given on the complaint. They were, however, able to advise me of several suspect vehicles in the area that should be checked:

First, one should be checked approximately 0.1 miles east on Clover Rd, north side of the road, just prior to the tracks, last name of KOPE. There should be a 1980s Blazer, full sized, standing in the yard with disabled RPs on it. The vehicle would match the description of the vehicle we are looking for.

Second, a vehicle should be checked just to the [REDACTED] and [REDACTED]. It is the last residence, an individual with the last name [REDACTED]. He has numerous trucks on his property. Perhaps, one would match.

Third, there is a vehicle they would question that is parked on Clover Rd, north side, first place east of Center Rd. The party has a full-sized silver truck.

Contact was made at [REDACTED] Clover Rd, and the disabled RP of 2432 was run. The Blazer turns out to be a 1984 GMC; however, it had no damage to the grill. This would not be a suspect vehicle as it has over-sized tires as well.

Officers drove up to the last residence...

MANITOWOC COUNTY SHERIFF'S DEPARTMENT
FOLLOW-UP REPORT

Page: 2

CASE NUMBER: 599-00433 CLASSIFICATION: _____

INCIDENT: _____

DATE AND TIME: _____

REPORT CONTINUED:

None of these match the description of the suspect vehicle.

Contact was made at the residence--first place east of Center Rd, north side of Clover Rd. Immediately upon entering the driveway, a full-sized Ford truck was observed. There was no damage to the front end. The vehicle does not match the suspect vehicle.

The [REDACTED] have lived in the area for a considerable amount of time and credit themselves with knowing most of the neighbors; however, they were unable to provide any further information.

Unless the complainant has more direct information, this is a dead-end complaint.

MJBushman *[Signature]* /bjc

S99 IN 00040 | 6,3|0,1| | 5,2|0,0,0

INCIDENT CARD

4. INCIDENT
CS/S99-00242

5. INCIDENT LOCATION

6. NAME- LAST-FIRST-MI
Anonymous (2)

7. D.O.B.

8. ADDRESS

9. TX-HOME

10. TX-BUSINESS

11. CITY STATE ZIP

12. DETAILS
see attached sheet

18. ASSIGNED
LENK 2014

19. REC. BY
924

20. DIS. BY

21. HOW REC'D.
1. 911
2. POLICE RADIO
3. PHONE
4. TTY
5. IN PERSON
6. ON VIEW
7. OFF. OFF DUTY
8. C.B. RADIO
9. OTHER

22. TYPE OF REPORT
1. INCIDENT
2. ACCIDENT
3. CITATION
4. NONE

23. STATUS
1. UNFOUNDED
2. PNL
3. OTHER
4. CLEARED
5. EXCEPT CLEARED

24. DATE CLEARED
03/08/99

25. OFFENSE TYPE
1. ADULT NA
2. JUVENILE
3. UNKNOWN

14. REC'D	15. DISP	16. 10-23	17. 10-24
13. DAY			
SUN 1	TH 5		
MON 2	FRI 6		
TUE 3	SAT 7		
WED 4			

39. (CODE S-SUSPECT W-WITNESS V-VICTIM O-OTHER)						
CODE	40. NAME-LAST	FIRST	MI	41. D.O.B.	42. ADDRESS	43. TELEPHONE

See pages 49-50 and 65 of S99-00242.

Closed, pending any further information. JMLenk /bjc

45. IF COMPLAINANT DIFFERENT THEN CALLER, ENTER NAME, ADDRESS, D.O.B., TELEPHONE.

46. IF CODE O (OTHER) IS USED IN FIELD #39, EXPLAIN.

INCIDENT REPORT: NOTE: IF SECTION 22 ABOVE HAS NUMBER 4 CHECKED, DO NOT GO BEYOND THIS LINE WITHOUT RECORDS SECTION BEING ADVISED, OR NO RECORD ENTRIES WILL BE MADE BELOW THIS LINE.

PROPERTY VALUE	26. PROPERTY	A. CURRENCY	B. JEWELRY	C. FURS CLOTHING	D. VEHICLE (LOCAL)	E. OFFICE EQUIPMENT	F. RADIO, TV CAMERAS	G. FIREARMS	H. HOUSE-HOLD GOODS
	STOLEN	\$	\$	\$	\$	\$	\$	\$	\$
	RECOVERED	\$	\$	\$	\$	\$	\$	\$	\$
	26. PROPERTY	I. CONSUMABLES	J. LIVESTOCK	K. DRUGS	L. MARINE ITEMS	M. CONSTRUCTION ITEMS	N. LAWN AND GARDEN	O. SPORTING GOODS	P. MISC BICYCLE
STOLEN	\$	\$	\$	\$	\$	\$	\$	\$	
RECOVERED	\$	\$	\$	\$	\$	\$	\$	\$	

27. PROPERTY RECOVERED: LOCALLY _____ OTHER JURISDICTION _____ (INSERT O OR L)

PROPERTY ITEMIZATION	PROPERTY STOLEN/RECOVERED ITEMIZATION, USE THE FOLLOWING FORMAT				
	28. QUANTITY	29. ARTICLE NAME	30. BRAND NAME	31. SERIAL NUMBER	32. CODE
					S R <input type="checkbox"/> <input type="checkbox"/>
					S R <input type="checkbox"/> <input type="checkbox"/>
					S R <input type="checkbox"/> <input type="checkbox"/>
					S R <input type="checkbox"/> <input type="checkbox"/>
					S R <input type="checkbox"/> <input type="checkbox"/>

33. PROPERTY DAMAGE AMOUNT \$ _____

34. INSURANCE COMPANY _____

35. OFFICER ASSAULTED Y N 36. ARSON Y N 37. STRUCTURE CODE _____ 38. DAMAGE \$ _____

47. CIB ENTERED CANCELLED
 NCIC
 OTHER BROADCAST

48. TOTAL AMOUNT PROPERTY STOLEN \$ _____

49. TOTAL AMOUNT PROPERTY RECOVERED \$ _____

50. IS REPORT CONTINUED? YES NO

51. CAUTION INDICATORS, ATLS ETC.

52. DATA PROCESS INFORMATION:

COMPUTER ENTERED DATE 3/8/99
 MICROFILM INDEXED INITIAL KS

53. FILE APPROVAL

IS CASE CLASSIFICATION CORRECT? IF N HAS CORRECTION BEEN MADE?

Y N
 Y N

BY [Signature] DATE 03/08/99

MANITOWOC
CITY OF MANITOWOC,
WISCONSIN, USA



MANITOWOC POLICE DEPARTMENT
JAY STREET
MANITOWOC WISCONSIN 54220

COVER PAGE FOR FAX DOCUMENT

The following will be a transmission from the Manitowoc Police
Department:

IMPORTANT

TO: MTSO

ATTN: Mike Bushman

DATE: 1/21/99 TIME: 11:40

FAX #: [REDACTED] PHONE #: _____

This transmission consists of 2 pages which includes this
cover sheet. Any trouble with this transmission or any questions,
please call [REDACTED].

Transmission sent by: DET. SGT. BUDWETLIK

NOTE: The FAX number for the Manitowoc Police Department
is [REDACTED]; TELEPHONE number is [REDACTED]



OFFICE OF CITY
POLICE DEPARTMENT

Richard H. Brey
Chief of Police

CITY OF MANITOWOC POLICE
INTELLIGENCE REPORT

DATE: 01-20-99

- NEW-All known identification of subjects needed

SUBJECTS: TODD
Fired from DITTRICH TRKG

Supplemental submission

SOURCE: FEMALE CALLER

WRITTEN REPORT:

Received a call from a female who stated that her husband and son work for DITTRICH TRUCKING in Sheboygan. They knew a male named TODD who also worked for DITTRICH and the subject drove a CHEV TRUCK (RED). TODD was fired from DITTRICH about 3 to 4 weeks ago. Approximately 2 weeks ago her husband and son saw TODD in the Manitowoc area with his red CHEV TRUCK and the truck was missing a grill and had front end damage. Caller believes the truck is between a 85 and 88 model. Caller also believes TODD lives in WEYAUWEGA. Caller did not want her name used but did want to participate in the reward program so I gave her the number for Crime Stoppers. Swetlik called info in to Bushman.
J BORMAN

Source of Information

-Informant -Investigation -Records -Citizen -Other

Evaluation of Source

A-Reliable B-Usually Reliable C-Fairly Reliable D-Not Usually Reliable E-Unreliable F-Reliability Unknown

Evaluation of Information

1-Confirmed True 2-Probably True 3-Possibly True 4-Doubtfully True 5-Improbable 6-Truth Be Judged

Criminal Area

-Narcotics -Burglary/Theft -Weapons -Vice -Other

S99 IN 00042 | 6,310,1 | 6,000,0

4. INCIDENT
CS/S98-00242

5. INCIDENT LOCATION
CTH CR

6. NAME - LAST-FIRST-MI
Anon -2-

7. D.O.B.

8. ADDRESS

9. TX-HOME

11. CITY STATE ZIP

10. TX-BUSINESS

12. DETAILS
456 Req. inc. for crime stopper report.

INCIDENT CARD

18. ASSIGNED
MTSO
O'Hearn 9/2/99
456

19. REC. BY
923

20. DIS. BY

21. HOW REC'D.
1. 911
2. POLICE RADIO
3. PHONE
4. TTY
5. IN PERSON
6. ON VIEW
7. OFF. OFF DUTY
8. C.B. RADIO
9. OTHER

22. TYPE OF REPORT
1. INCIDENT
2. ACCIDENT
3. CITATION
4. NONE

23. STATUS
1. UNFOUNDED
2. PNL
3. OTHER
4. CLEARED
5. EXCEPT CLEARED

24. DATE CLEARED
08/08/99

25. OFFENSE TYPE
1. ADULT NA
2. JUVENILE
3. UNKNOWN

13. DAY
SUN 1 THU 5
MON 2 FRI 6
TUE 3 SAT 7
WED 4

39. (CODE S-SUSPECT W-WITNESS V-VICTIM O-OTHER)	40. NAME-LAST	FIRST	MI	41. D.O.B.	42. ADDRESS	43. TELEPHONE
X0	WEYKER	JEREMY		11/01/30	N 40th St, Sheboygan	
0	WEYKER	ANTHONY (father of JEREMY)			N 40th St, Sheboygan	
0						
0						
0						

01/20/99 @ 1120 Hrs.: I, Lt. O'Hearn, received information from Sgt. Larry Zimney of MTPD that he had been contacted by a woman who only identified herself as the grandmother of [redacted]. She stated her granddaughter, [redacted] (she does not know where she lives at this time), [redacted] an individual by the name of JEREMY WEYKER. The spelling of the last name WEYKER was a confusion on both the grandmother's and Officer Zimney's part. They do not know if it is RICHER or IRCHART. The grandmother stated he lives somewhere in Sheboygan on a farm near the MENARD'S store and that he owns a gray Chevy pickup truck which matches the description we are looking for and that she believes he was up here on the night of the accident. Sgt. Zimney also informed me that he did some checking and found the parents of [redacted], are [redacted] and [redacted] who live at a residence on CTH Q. Further checking revealed in-house that the [redacted] live at [redacted] Manitowoc.

01/21/99 @ 0650 Hrs.: I met with [redacted] and [redacted] at their residence. They stated their daughter, [redacted], is not residing with them at this time. They seemed hesitant to give me the address of where she was but stated she is also [redacted] JEREMY WEYKER which is a different name than the one I received from Sgt. Zimney. It is spelled W-E-Y-K-E-R. Her mother stated they are [redacted], but she could give me a phone number and address of JEREMY as they know he lives in Sheboygan. JEREMY'S address and phone number were obtained. They also stated he owns a grayish Chevy pickup truck, but they have not see him in some time.

It should be noted all information was passed on to SBSO to check this residence at [redacted] N 40th St, Sheboygan (Sheboygan Co.), where they could meet with JEREMY.

01/21/99 @ 1020 Hrs.: I received a call from Deputy DeBlay of SBSO, phone of [redacted]. Deputy DeBlay stated she has made contact with JEREMY and his father, ANTHONY WEYKER. She inspected both ANTHONY'S and the gray GMC truck owned by JEREMY. Both vehicles were intact and had no damage whatsoever.

45. IF COMPLAINANT DIFFERENT THEN CALLER, ENTER NAME, ADDRESS, D.O.B., TELEPHONE.

46. IF CODE O (OTHER) IS USED IN FIELD #39, EXPLAIN.

INCIDENT REPORT: NOTE: IF SECTION 22 ABOVE HAS NUMBER 4 CHECKED, DO NOT GO BEYOND THIS LINE WITHOUT RECORDS SECTION BEING ADVISED, OR NO RECORD ENTRIES WILL BE MADE BELOW THIS LINE.

PROPERTY VALUE	26. PROPERTY	A. CURRENCY	B. JEWELRY	C. FURS CLOTHING	D. VEHICLE (LOCAL)	E. OFFICE EQUIPMENT	F. RADIO, TV CAMERAS	G. FIREARMS	H. HOUSE-HOLD GOODS
	STOLEN	\$	\$	\$	\$	\$	\$	\$	\$
	RECOVERED	\$	\$	\$	\$	\$	\$	\$	\$
	26. PROPERTY	I. CONSUMABLES	J. LIVESTOCK	K. DRUGS	L. MARINE ITEMS	M. CONSTRUCTION ITEMS	N. LAWN AND GARDEN	O. SPORTING GOODS	P. MISC BICYCLE
	STOLEN	\$	\$	\$	\$	\$	\$	\$	\$
	RECOVERED	\$	\$	\$	\$	\$	\$	\$	\$

27. PROPERTY RECOVERED: LOCALLY _____ OTHER JURISDICTION _____ (INSERT O OR L)

PROPERTY ITEMIZATION	PROPERTY STOLEN/RECOVERED ITEMIZATION, USE THE FOLLOWING FORMAT				
	28. QUANTITY	29. ARTICLE NAME	30. BRAND NAME	31. SERIAL NUMBER	32. CODE
					S <input type="checkbox"/> R <input type="checkbox"/>
					S <input type="checkbox"/> R <input type="checkbox"/>
					S <input type="checkbox"/> R <input type="checkbox"/>
					S <input type="checkbox"/> R <input type="checkbox"/>
					S <input type="checkbox"/> R <input type="checkbox"/>
					S <input type="checkbox"/> R <input type="checkbox"/>

33. PROPERTY DAMAGE AMOUNT \$ _____ 34. INSURANCE COMPANY _____

35. OFFICER ASSAULTED Y N 36. ARSON Y N 37. STRUCTURE CODE _____ 38. DAMAGE \$ _____

47. CIB ENTERED CANCELLED
 NCIC
 OTHER BROADCAST

48. TOTAL AMOUNT PROPERTY STOLEN \$ _____

49. TOTAL AMOUNT PROPERTY RECOVERED \$ _____

50. IS REPORT CONTINUED? YES NO

51. CAUTION INDICATORS, ATLS ETC.

52. DATA PROCESS INFORMATION:
 COMPUTER ENTERED DATE 3.8.99
 MICROFILM INDEXED INITIAL KS
 IS CASE CLASSIFICATION CORRECT? Y N
 IF N HAS CORRECTION BEEN MADE? Y N

53. FILE APPROVAL
 BY [Signature] DATE 03.08.99
 MCSD 028 1/91

395 IV- 00/10 16,20,11, 17,210,00

4. INCIDENT CS (99-00242)

5. INCIDENT LOCATION _____

6. NAME - LAST - FIRST - MI ANONYMOUS (2) 7. D.O.B. _____

8. ADDRESS _____ 9. TX-HOME _____

11. CITY _____ STATE _____ ZIP _____ 10. TX-BUSINESS _____

12. DETAILS
Caller states a Scott
COMPTON (25-35yo) just got
out of jail in either GBPD
or BRSD, has 2 friends w/
Blazers or Club Trucks -

INCIDENT CARD

18. ASSIGNED MTSO 9129

19. REC. BY 945 20. DIS. BY _____

21. HOW REC'D.
 1. 911
 2. POLICE RADIO
 3. PHONE
 4. TTY
 5. IN PERSON
 6. ON VIEW
 7. OFF. OFF DUTY
 8. C.B. RADIOS
 9. OTHER CS

22. TYPE OF REPORT
 1. INCIDENT
 2. ACCIDENT
 3. CITATION
 4. NONE

23. STATUS
 1. UNFOUNDED
 2. PNL
 3. OTHER
 4. CLEARED
 5. EXCEPT CLEARED

24. DATE CLEARED 108 108 199

25. OFFENSE TYPE
 1. ADULT NA
 2. JUVENILE
 3. UNKNOWN

14. REC'D. 15. DISP. 16. 10-23 17. 10-24

13. DAY
 SUN 1 THU 5
 MON 2 FRI 6
 TUE 3 SAT 7
 WED 4

39. (CODE S-SUSPECT W-WITNESS V-VICTIM O-OTHER)

CODE	40. NAME-LAST	FIRST	MI	41. D.O.B.	42. ADDRESS	43. TELEPHONE
O	Compton Diana S.	89047		██████	██████ W. Belmar Ave. Maribel	██████
S	Compton, Scott					

Mom has different last name, lives in Mishicot. Subject lives somewhere in Green Bay. Caller believes he could have done this. 945pg

02/17/99 Scott Compton is currently in the Brown County Jail since 02/03/99. Previous visit to Brown Co. Jail 09/12/98-09/14/98.

Contact attempted with Diana Compton by phone, message left on machine, 1222hrs.M. J. Bushman
 02/18/99 Call back from Diane Compton, not related. M.J. Bushman

MJB

45. IF COMPLAINANT DIFFERENT THEN CALLER, ENTER NAME, ADDRESS, D.O.B., TELEPHONE.

46. IF CODE O (OTHER) IS USED IN FIELD #39, EXPLAIN.

INCIDENT REPORT: NOTE: IF SECTION 22 ABOVE HAS NUMBER 4 CHECKED, DO NOT GO BEYOND THIS LINE WITHOUT RECORDS SECTION BEING ADVISED, OR NO RECORD ENTRIES WILL BE MADE BELOW THIS LINE.

PROPERTY VALUE	26. PROPERTY	A. CURRENCY	B. JEWELRY	C. FURS CLOTHING	D. VEHICLE (LOCAL)	E. OFFICE EQUIPMENT	F. RADIO, TV CAMERAS	G. FIREARMS	H. HOUSE-HOLD GOODS
	STOLEN	\$	\$	\$	\$	\$	\$	\$	\$
	RECOVERED	\$	\$	\$	\$	\$	\$	\$	\$
	26. PROPERTY	I. CONSUMABLES	J. LIVESTOCK	K. DRUGS	L. MARINE ITEMS	M. CONSTRUCTION ITEMS	N. LAWN AND GARDEN	O. SPORTING GOODS	P. MISC BICYCLE
	STOLEN	\$	\$	\$	\$	\$	\$	\$	\$
	RECOVERED	\$	\$	\$	\$	\$	\$	\$	\$

27. PROPERTY RECOVERED: LOCALLY ____ OTHER JURISDICTION ____ (INSERT O OR L)

PROPERTY ITEMIZATION	PROPERTY STOLEN/RECOVERED ITEMIZATION, USE THE FOLLOWING FORMAT				
	28. QUANTITY	29. ARTICLE NAME	30. BRAND NAME	31. SERIAL NUMBER	32. CODE
					S R <input type="checkbox"/> <input type="checkbox"/>
					S R <input type="checkbox"/> <input type="checkbox"/>
					S R <input type="checkbox"/> <input type="checkbox"/>
					S R <input type="checkbox"/> <input type="checkbox"/>
					S R <input type="checkbox"/> <input type="checkbox"/>

33. PROPERTY DAMAGE AMOUNT \$ _____ 34. INSURANCE COMPANY _____

35. OFFICER ASSAULTED Y N 36. ARSON Y N 37. STRUCTURE CODE _____ 38. DAMAGE \$ _____

47. CIB	ENTERED <input type="checkbox"/>	CANCELLED <input type="checkbox"/>	48. TOTAL AMOUNT PROPERTY STOLEN \$ _____
NCIC	<input type="checkbox"/>	<input type="checkbox"/>	
OTHER BROADCAST	<input type="checkbox"/>	<input type="checkbox"/>	49. TOTAL AMOUNT PROPERTY RECOVERED \$ _____

50. IS REPORT CONTINUED? YES NO 51. CAUTION INDICATORS, ATLS ETC.

52. DATA PROCESS INFORMATION:

COMPUTER ENTERED DATE 3/8/99

MICROFILM INDEXED INITIAL KS

IS CASE CLASSIFICATION CORRECT? N

IF N HAS CORRECTION BEEN MADE? N

53. FILE APPROVAL

BY KP DATE 03/08/99

S99 INC 00010 103121 1141011

4. INCIDENT
CS / S99-00242

5. INCIDENT LOCATION
Hwy CR + Silv. Crk. Rd.

6. NAME - LAST FIRST - MI
Anonymous

7. D.O.B.

8. ADDRESS

9. TX-HOME

11. CITY STATE ZIP

10. TX-BUSINESS

12. DETAILS
Caller states [redacted]
[redacted] (18 yoa, approx.)
resides at [redacted]
Apt. # 38) has a

14. RECD

15. DISP

16. 10-23

17. 10-24

13. DAY
SUN 1 THU 5
MON 2 FRI 6
TUE 3 SAT 7
WED 4

INCIDENT CARD

18. ASSIGNED
Det. Sgt. Lenk 2014

19. REC. BY
925925

20. DIS. BY

22. TYPE OF REPORT
1. INCIDENT
2. ACCIDENT
3. CITATION
4. NONE

23. STATUS
1. UNFOUNDED
2. PNL
3. OTHER
4. CLEARED
5. EXCEPT CLEARED

24. DATE CLEARED
1030899

25. OFFENSE TYPE
1. ADULT NA
2. JUVENILE
3. UNKNOWN

ACTIVE

39. (CODE S-SUSPECT W-WITNESS V-VICTIM O-OTHER)						
CODE	40. NAME-LAST	FIRST	MI	41. D.O.B.	42. ADDRESS	43. TELEPHONE
S	Reichwaldt, Philip	C.		[redacted]	[redacted] CTH C, Mtwc	[redacted]

friend who is dating a male party with first name "Phil." Phil told his [redacted] that he struck something at above location on 01-10-99 but didn't know what it was, and didn't stop. [redacted] and her friend both work at Walmart. Info regarding Phil's vehicle is unknown. SE SE

02/17/99 Philip Reichwaldt was the suspect in the above narrative and has been investigated by several Officers in another complaint, S99-01178. Closed at this time pending other more direct information. M.J. Bushma

45. IF COMPLAINANT DIFFERENT THEN CALLER, ENTER NAME, ADDRESS, D.O.B., TELEPHONE.

46. IF CODE O (OTHER) IS USED IN FIELD #39, EXPLAIN.

INCIDENT REPORT: NOTE: IF SECTION 22 ABOVE HAS NUMBER 4 CHECKED, DO NOT GO BEYOND THIS LINE WITHOUT RECORDS SECTION BEING ADVISED, OR NO RECORD ENTRIES WILL BE MADE BELOW THIS LINE.

PROPERTY VALUE	26. PROPERTY	A. CURRENCY	B. JEWELRY	C. FURS CLOTHING	D. VEHICLE (LOCAL)	E. OFFICE EQUIPMENT	F. RADIO, TV CAMERAS	G. FIREARMS	H. HOUSE-HOLD GOODS
	STOLEN	\$	\$	\$	\$	\$	\$	\$	\$
	RECOVERED	\$	\$	\$	\$	\$	\$	\$	\$
	26. PROPERTY	I. CONSUMABLES	J. LIVESTOCK	K. DRUGS	L. MARINE ITEMS	M. CONSTRUCTION ITEMS	N. LAWN AND GARDEN	O. SPORTING GOODS	P. MISC BICYCLE
	STOLEN	\$	\$	\$	\$	\$	\$	\$	\$
	RECOVERED	\$	\$	\$	\$	\$	\$	\$	\$

27. PROPERTY RECOVERED: LOCALLY _____ OTHER JURISDICTION _____ (INSERT O OR L)

PROPERTY ITEMIZATION	PROPERTY STOLEN/RECOVERED ITEMIZATION, USE THE FOLLOWING FORMAT				
	28. QUANTITY	29. ARTICLE NAME	30. BRAND NAME	31. SERIAL NUMBER	32. CODE
					S R <input type="checkbox"/> <input type="checkbox"/>
					S R <input type="checkbox"/> <input type="checkbox"/>
					S R <input type="checkbox"/> <input type="checkbox"/>
					S R <input type="checkbox"/> <input type="checkbox"/>
					S R <input type="checkbox"/> <input type="checkbox"/>

33. PROPERTY DAMAGE AMOUNT \$ _____

34. INSURANCE COMPANY _____

35. OFFICER ASSAULTED Y N

36. ARSON Y N

37. STRUCTURE CODE _____ 38. DAMAGE \$ _____

47. CIB ENTERED CANCELLED
 NCIC
 OTHER BROADCAST

48. TOTAL AMOUNT PROPERTY STOLEN \$ _____

49. TOTAL AMOUNT PROPERTY RECOVERED \$ _____

50. IS REPORT CONTINUED? YES NO

51. CAUTION INDICATORS, ATLS ETC.

52. DATA PROCESS INFORMATION:

COMPUTER ENTERED DATE 13.8.99

MICROFILM INDEXED INITIAL KS

IS CASE CLASSIFICATION CORRECT? Y N
 IF N HAS CORRECTION BEEN MADE? Y N

53. FILE APPROVAL

BY KS DATE 13.08.99

S99 INC 00031 650.11. 3200.0

INCIDENT CARD

4. INCIDENT NT **CIS S99-00242**

5. INCIDENT LOCATION

6. NAME-LAST-FIRST-MI **Dhony Moss** 7. D.O.B.

8. ADDRESS 9. TX-HOME

11. CITY STATE ZIP 10. TX-BUSINESS

12. DETAILS **see attached**

18. ASSIGNED

19. REC. BY **921** 20. DIS. BY

22. TYPE OF REPORT
 1. INCIDENT
 2. ACCIDENT
 3. CITATION
 4. NONE

21. HOW REC'D.
 1. 911
 2. POLICE RADIO
 3. PHONE
 4. TTY
 5. IN PERSON
 6. ON VIEW
 7. OFF. OFF DUTY
 8. C.B. RADIO
 9. OTHER

23. STATUS
 1. UNFOUNDED
 2. PNL
 3. OTHER
 4. CLEARED
 5. EXCEPT CLEARED

24. DATE CLEARED **03/08/99**

25. OFFENSE TYPE
 1. ADULT NA
 2. JUVENILE
 3. UNKNOWN

14. REC'D	15. DISP	16. 10-23	17. 10-24
13. DAY			
SUN 1	THU 5		
MON 2	FRI 6		
TUE 3	SAT 7		
WED 4			

39. (CODE S-SUSPECT W-WITNESS V-VICTIM O-OTHER)				41. D.O.B.		42. ADDRESS		43. TELEPHONE
CODE	40. NAME-LAST	FIRST	MI					
0	Frye, Robert L					bicentennial Ct #87 Kaukauna		
	Pierce Mfg.					Appleton		

02/22/99 Attempted contact by phone at his residence and Peirce Mfg in Appleton, no answer in residence answering machine at factory. Attempt later. M.J. Bushman

02/23/99 1855hrs Contact made with Robert Frye's wife. She stated Robert just stepped out of the house and asked to take a message. She was questioned about whether her husband still owns the Chev truck and does it have damage. She stated he was driving it now and it was involved in an accident in Oconto County near Mountain when he slid off the road and hit a tree the weekend prior to Thanksgiving. She stated an accident report was filed and she remembered it because he was mad when issued a citation. The vehicle was not fixed from that incident.

Contact made by phone with Oconto County Sheriff Department, and I spoke with dispatcher. She was able to pull up on computer screen Robert L. Frye's information and Accident report number 10388, citation #Y49448. She thought one character on each number was missing as Oconto Co. SO has had a computer changeover and the screen is off center. She advised to call back during day office hours talk with Benita [redacted]. I am satisfied the damage was caused to the vehicle in Oconto County, close complaint. M.J. Bushman

45. IF COMPLAINANT DIFFERENT THEN CALLER, ENTER NAME, ADDRESS, D.O.B., TELEPHONE.

46. IF CODE O (OTHER) IS USED IN FIELD #39, EXPLAIN.

INCIDENT REPORT: NOTE: IF SECTION 22 ABOVE HAS NUMBER 4 CHECKED, DO NOT GO BEYOND THIS LINE WITHOUT RECORDS SECTION BEING ADVISED, OR NO RECORD ENTRIES WILL BE MADE BELOW THIS LINE.

PROPERTY VALUE	26. PROPERTY	A. CURRENCY	B. JEWELRY	C. FURS CLOTHING	D. VEHICLE (LOCAL)	E. OFFICE EQUIPMENT	F. RADIO, TV CAMERAS	G. FIREARMS	H. HOUSE-HOLD GOODS
	STOLEN	\$	\$	\$	\$	\$	\$	\$	\$
	RECOVERED	\$	\$	\$	\$	\$	\$	\$	\$
	26. PROPERTY	I. CONSUMABLES	J. LIVESTOCK	K. DRUGS	L. MARINE ITEMS	M. CONSTRUCTION ITEMS	N. LAWN AND GARDEN	O. SPORTING GOODS	P. MISC BICYCLE
	STOLEN	\$	\$	\$	\$	\$	\$	\$	\$
	RECOVERED	\$	\$	\$	\$	\$	\$	\$	\$

27. PROPERTY RECOVERED: LOCALLY _____ OTHER JURISDICTION _____ (INSERT O OR L)

PROPERTY ITEMIZATION	PROPERTY STOLEN/RECOVERED ITEMIZATION, USE THE FOLLOWING FORMAT				
	28. QUANTITY	29. ARTICLE NAME	30. BRAND NAME	31. SERIAL NUMBER	32. CODE
					S R <input type="checkbox"/> <input type="checkbox"/>
					S R <input type="checkbox"/> <input type="checkbox"/>
					S R <input type="checkbox"/> <input type="checkbox"/>
					S R <input type="checkbox"/> <input type="checkbox"/>
					S R <input type="checkbox"/> <input type="checkbox"/>

33. PROPERTY DAMAGE AMOUNT \$ _____

34. INSURANCE COMPANY _____

35. OFFICER ASSAULTED Y N

36. ARSON Y N

37. STRUCTURE CODE _____

38. DAMAGE \$ _____

47. CIB ENTERED CANCELLED
 NCIC
 OTHER BROADCAST

48. TOTAL AMOUNT PROPERTY STOLEN \$ _____

49. TOTAL AMOUNT PROPERTY RECOVERED \$ _____

50. IS REPORT CONTINUED? YES NO

51. CAUTION INDICATORS, ATLS ETC.

52. DATA PROCESS INFORMATION:

COMPUTER ENTERED DATE 3/8/99

MICROFILM INDEXED INITIAL KS

IS CASE CLASSIFICATION CORRECT? N
 IF N HAS CORRECTION BEEN MADE? N

53. FILE APPROVAL

BY [Signature] DATE 3/8/99

S99 No 00436 639.11 \$2000

MAINTENANCE COURT SHERIFF
INCIDENT CARD

4. INCIDENT **CS** **00242**

5. INCIDENT LOCATION

6. NAME - LAST - FIRST - MI **Anonymous** 7. D.O.B.

8. ADDRESS 9. TX-HOME

11. CITY STATE ZIP 10. TX-BUSINESS

12. DETAILS
See attached
Kaukauna checking

14. REC'D	15. DISP	16. 10-23	17. 10-24
13. DAY			
SUN 1	THU 5		
MON 2	FRI 6		
TUE 3	SAT 7		
WED 4			

18. ASSIGNED

19. REC. BY **921** 20. DIS. BY

21. HOW REC'D.
1. 911
2. POLICE RADIO
3. PHONE
4. TTY
5. IN PERSON
6. ON VIEW
7. OFF. OFF DUTY
8. C.B. RADIO
9. OTHER

22. TYPE OF REPORT
1. INCIDENT
2. ACCIDENT
3. CITATION
4. NONE

23. STATUS
1. UNFOUNDED
2. PNL
3. **OTHER**
4. CLEARED
5. EXCEPT CLEARED

24. DATE CLEARED **02/16/99**

25. OFFENSE TYPE
1. ADULT NA
2. JUVENILE
3. UNKNOWN

39. (CODE S-SUSPECT W-WITNESS V-VICTIM O-OTHER)				42. ADDRESS		43. TELEPHONE
CODE	40. NAME-LAST	FIRST	MI	41. D.O.B.		

02/16/99 Vehicle had been checked by Police agency with Officer calling MTSO by phone. The damage described was to the Rt. Front fender and passenger dorr. The Officer stated it looked like he struck a metal guard rail. Not the vehicle we're looking for, close only

M.J. Bushman

45. IF COMPLAINANT DIFFERENT THEN CALLER, ENTER NAME, ADDRESS, D.O.B., TELEPHONE.

46. IF CODE O (OTHER) IS USED IN FIELD #39, EXPLAIN.

INCIDENT REPORT: NOTE: IF SECTION 22 ABOVE HAS NUMBER 4 CHECKED, DO NOT GO BEYOND THIS LINE WITHOUT RECORDS SECTION BEING ADVISED, OR NO RECORD ENTRIES WILL BE MADE BELOW THIS LINE.

PROPERTY VALUE	26. PROPERTY	A. CURRENCY	B. JEWELRY	C. FURS CLOTHING	D. VEHICLE (LOCAL)	E. OFFICE EQUIPMENT	F. RADIO, TV CAMERAS	G. FIREARMS	H. HOUSE-HOLD GOODS
	STOLEN	\$	\$	\$	\$	\$	\$	\$	\$
	RECOVERED	\$	\$	\$	\$	\$	\$	\$	\$
	26. PROPERTY	I. CONSUMABLES	J. LIVESTOCK	K. DRUGS	L. MARINE ITEMS	M. CONSTRUCTION ITEMS	N. LAWN AND GARDEN	O. SPORTING GOODS	P. MISC BICYCLE
STOLEN	\$	\$	\$	\$	\$	\$	\$	\$	
RECOVERED	\$	\$	\$	\$	\$	\$	\$	\$	

27. PROPERTY RECOVERED: LOCALLY _____ OTHER JURISDICTION _____ (INSERT O OR L)

PROPERTY ITEMIZATION	PROPERTY STOLEN/RECOVERED ITEMIZATION, USE THE FOLLOWING FORMAT				
	28. QUANTITY	29. ARTICLE NAME	30. BRAND NAME	31. SERIAL NUMBER	32. CODE
					S R <input type="checkbox"/> <input type="checkbox"/>
					S R <input type="checkbox"/> <input type="checkbox"/>
					S R <input type="checkbox"/> <input type="checkbox"/>
					S R <input type="checkbox"/> <input type="checkbox"/>
					S R <input type="checkbox"/> <input type="checkbox"/>

33. PROPERTY DAMAGE AMOUNT \$ _____

34. INSURANCE COMPANY _____

35. OFFICER ASSAULTED Y N 36. ARSON Y N 37. STRUCTURE CODE _____ 38. DAMAGE \$ _____

47. CIB ENTERED CANCELLED
 NCIC
 OTHER BROADCAST

48. TOTAL AMOUNT PROPERTY STOLEN \$ _____

49. TOTAL AMOUNT PROPERTY RECOVERED \$ _____

50. IS REPORT CONTINUED? YES NO

51. CAUTION INDICATORS, ATLS ETC.

52. DATA PROCESS INFORMATION:

COMPUTER ENTERED DATE 3.8.99
 MICROFILM INDEXED INITIAL AS

53. FILE APPROVAL

IS CASE CLASSIFICATION CORRECT? N
 IF N HAS CORRECTION BEEN MADE? N

BY [Signature] DATE 03.08.99

1. CASE # **S99 No 01642** 2. CLASSIFICATION **6,310,11** 3. CENSUS **7,010,0,0**

4. INCIDENT **S99-00242**
 INCIDENT LOCATION

6. NAME LAST-FIRST-MI **Anonymous** 7. D.O.B.

8. ADDRESS 9. TX-HOME

11. CITY STATE ZIP 10. TX-BUSINESS

12. DETAILS **See Attached**

02/25/99 1535
 REC'D 14. 15. 16. 17.
 DISP 10-23 10-24
 13. DAY
 SUN 1 THU 5
 MON 2 FRI 6
 TUE 3 SAT 7
 WED 4

MANITOWOC COUNTY SHERIFF INCIDENT CARD

18. ASSIGNED MTSO **Rushman** **H/W** 9/2/9

19. REC. BY **935** 20. DIS. BY
 22. TYPE OF REPORT
 1. INCIDENT
 2. ACCIDENT
 3. CITATION
 4. NONE

21. HOW REC'D.
 1. 911
 2. POLICE RADIO
 3. PHONE
 4. TTY
 5. IN PERSON
 6. ON VIEW
 7. OFF. OFF DUTY
 8. C.B. RADIO
 9. OTHER
 21A. M.O.
 23. STATUS
 1. UNFOUNDED
 2. PNL
 3. OTHER
 4. CLEARED
 5. EXCEPT CLEARED
 24. DATE CLEARED **03/08/99**
 25. OFFENSE TYPE
 1. ADULT NA
 2. JUVENILE
 3. UNKNOWN

39. (CODE S-SUSPECT W-WITNESS V-VICTIM O-OTHER)

CODE	40. NAME-LAST	FIRST	MI	41. D.O.B.	42. ADDRESS	43. TELEPHONE

02/25/99 1620hrs Vehicle description given by the complainant and the 10-28 varification do not match the suspect vehicle at all. Close Complaint. M.J. Bushman

45. IF COMPLAINANT DIFFERENT THEN CALLER, ENTER NAME, ADDRESS, D.O.B., TELEPHONE.

46. IF CODE O (OTHER) IS USED IN FIELD #39, EXPLAIN.

INCIDENT REPORT: NOTE: IF SECTION 22 ABOVE HAS NUMBER 4 CHECKED, DO NOT GO BEYOND THIS LINE WITHOUT RECORDS SECTION BEING ADVISED, OR NO RECORD ENTRIES WILL BE MADE BELOW THIS LINE.

PROPERTY VALUE	26. PROPERTY	A. CURRENCY	B. JEWELRY	C. FURS CLOTHING	D. VEHICLE (LOCAL)	E. OFFICE EQUIPMENT	F. RADIO, TV CAMERAS	G. FIREARMS	H. HOUSE-HOLD GOODS
	STOLEN	\$	\$	\$	\$	\$	\$	\$	\$
	RECOVERED	\$	\$	\$	\$	\$	\$	\$	\$
	26. PROPERTY	I. CONSUMABLES	J. LIVESTOCK	K. DRUGS	L. MARINE ITEMS	M. CONSTRUCTION ITEMS	N. LAWN AND GARDEN	O. SPORTING GOODS	P. MISC BICYCLE
STOLEN	\$	\$	\$	\$	\$	\$	\$	\$	
RECOVERED	\$	\$	\$	\$	\$	\$	\$	\$	

27. PROPERTY RECOVERED: LOCALLY _____ OTHER JURISDICTION _____ (INSERT O OR L)

PROPERTY ITEMIZATION	PROPERTY STOLEN/RECOVERED ITEMIZATION, USE THE FOLLOWING FORMAT				
	28. QUANTITY	29. ARTICLE NAME	30. BRAND NAME	31. SERIAL NUMBER	
					S <input type="checkbox"/> R <input type="checkbox"/>
					S <input type="checkbox"/> R <input type="checkbox"/>
					S <input type="checkbox"/> R <input type="checkbox"/>
					S <input type="checkbox"/> R <input type="checkbox"/>

33. PROPERTY DAMAGE AMOUNT \$ _____

34. INSURANCE COMPANY _____

35. OFFICER ASSAULTED Y N

36. ARSON Y N

37. STRUCTURE CODE _____ 38. DAMAGE \$ _____

47. CIB ENTERED CANCELLED
 NCIC
 OTHER BROADCAST

48. TOTAL AMOUNT PROPERTY STOLEN \$ _____

49. TOTAL AMOUNT PROPERTY RECOVERED \$ _____

50. IS REPORT CONTINUED? YES NO

51. CAUTION INDICATORS, ATLS ETC.

52. DATA PROCESS INFORMATION:

COMPUTER ENTERED DATE 3.8.99
 MICROFILM INDEXED INITIAL AS

IS CASE CLASSIFICATION CORRECT? Y N
 IF N HAS CORRECTION BEEN MADE? Y N

53. FILE APPROVAL

BY [Signature] DATE 03.08.99

1. CASE # S99 No 01648
 2. CLASSIFICATION 631011
 3. CENSUS 7.0100.0

4. INCIDENT CS / S99-00242

5. INCIDENT LOCATION Oshkosh - Bergstrom olds

6. NAME - LAST - FIRST - MI ANONY.
 7. D.O.B.

8. ADDRESS
 9. TX-HOME

11. CITY STATE ZIP
 10. TX-BUSINESS

12. DETAILS See Attached worksheet.

2032
02-25-99

MANITOWOC COUNTY SHERIFF
INCIDENT CARD

18. ASSIGNED
 Bushman 929
 WHH

19. REC. BY 938
 20. DIS. BY

21. HOW REC'D.
 1. 911
 2. POLICE RADIO
 3. PHONE
 4. TTY
 5. IN PERSON
 6. ON VIEW
 7. OFF. OFF DUTY
 8. C.B. RADIO
 9. OTHER

22. TYPE OF REPORT
 1. INCIDENT
 2. ACCIDENT
 3. CITATION
 4. NONE

23. STATUS
 1. UNFOUNDED
 2. PNL
 3. OTHER
 4. CLEARED
 5. EXCEPT CLEARED

24. DATE CLEARED 03/08/99

25. OFFENSE TYPE
 1. ADULT NA
 2. JUVENILE
 3. UNKNOWN

14. REC'D	15. DISP	16. 10-23	17. 10-24
13. DAY			
SUN 1	THU 5		
MON 2	FRI 6		
TUE 3	SAT 7		
WED 4			

39. (CODE S-SUSPECT W-WITNESS V-VICTIM O-OTHER)				41. D.O.B.		42. ADDRESS		43. TELEPHONE
CODE	40. NAME - LAST	FIRST	MI					
0	Konetzke, Gary L.					E. Wisconsin Ave. Appleton		
	Hawk's Nest					W. Main, Little Chute		

02/26/99 2045hrs Contact with the complainant who is a mechanic at Bergstrom, Oshkosh, but did not work on the van. It is blue color with large patches of gray primer showing. It could be a 3/4 ton cargo van. Grille is gone with sheet metal damage to the hood, and bumper. Mechanic states he once saw a vehicle which struck a human and this damage resembled that type, soft not sharp object.

2100hrs Spoke with owner Konetzke by phone at his bar the Hawk's Nest in Little Chute. He stated he hit a tree two years ago but did not make out an accident report. Seemed a bit uncomfortable on the phone or it may have been the loud background noise from the bar. He agreed to have an officer look at the vehicle.

2108hrs Contact made with Shift commander Sgt. Dave Spaeth. He stated he was not busy and would check it out for us right away. M.J. Bushman

2140hrs Sgt. Spaeth called back. Grille is completely gone, minor sheet metal damage and bumper, some rust behind where grille was and no radiator damage. Windshield not damaged and it appears to be old, not a replace. Poloroid pictures taken and will be mailed. Sgt. Spaeth went into talk with Konetzke and other patrons. Konetzke was not the least bit worried about it and very cooperative. Report and pictures will be mailed to MTSO
 M.J. Bushman

S99 No 01648

45. IF COMPLAINANT DIFFERENT THEN CALLER, ENTER NAME, ADDRESS, D.O.B., TELEPHONE.

46. IF CODE O (OTHER) IS USED IN FIELD #39, EXPLAIN.

INCIDENT REPORT: NOTE: IF SECTION 22 ABOVE HAS NUMBER 4 CHECKED, DO NOT GO BEYOND THIS LINE WITHOUT RECORDS SECTION BEING ADVISED; OR NO RECORD ENTRIES WILL BE MADE BELOW THIS LINE.

PROPERTY VALUE	26. PROPERTY	A. CURRENCY	B. JEWELRY	C. FURS CLOTHING	D. VEHICLE (LOCAL)	E. OFFICE EQUIPMENT	F. RADIO, TV CAMERAS	G. FIREARMS	H. HOUSE-HOLD GOODS
	STOLEN	\$	\$	\$	\$	\$	\$	\$	\$
	RECOVERED	\$	\$	\$	\$	\$	\$	\$	\$
	26. PROPERTY	I. CONSUMABLES	J. LIVESTOCK	K. DRUGS	L. MARINE ITEMS	M. CONSTRUCTION ITEMS	N. LAWN AND GARDEN	O. SPORTING GOODS	P. MISC BICYCLE
STOLEN	\$	\$	\$	\$	\$	\$	\$	\$	
RECOVERED	\$	\$	\$	\$	\$	\$	\$	\$	

27. PROPERTY RECOVERED: LOCALLY _____ OTHER JURISDICTION _____ (INSERT O OR L)

PROPERTY STOLEN/RECOVERED ITEMIZATION: USE THE FOLLOWING FORMAT

PROPERTY ITEMIZATION	28. QUANTITY	29. ARTICLE NAME	30. BRAND NAME	31. SERIAL NUMBER	32. CODE
					S R <input type="checkbox"/> <input type="checkbox"/>
					S R <input type="checkbox"/> <input type="checkbox"/>
					S R <input type="checkbox"/> <input type="checkbox"/>
					S R <input type="checkbox"/> <input type="checkbox"/>

33. PROPERTY DAMAGE AMOUNT \$ _____

34. INSURANCE COMPANY _____

35. OFFICER ASSAULTED Y N

36. ARSON Y N

37. STRUCTURE CODE _____

38. DAMAGE \$ _____

47. CIB

ENTERED

CANCELLED

NCIC

OTHER BROADCAST

48. TOTAL AMOUNT PROPERTY STOLEN \$ _____

49. TOTAL AMOUNT PROPERTY RECOVERED \$ _____

50. IS REPORT CONTINUED? YES NO

51. CAUTION INDICATORS, ATLS ETC.

52. DATA PROCESS INFORMATION:

COMPUTER ENTERED

DATE

13.8.99

MICROFILM INDEXED

INITIAL

KS

IS CASE CLASSIFICATION CORRECT?
IF N HAS CORRECTION BEEN MADE?

Y N

53. FILE APPROVAL

BY

[Signature]

DATE

13.8.99

1. CASE # S99 No 1668 | 2. CLASSIFICATION 0301 | 3. CENSUS 391000

4. INCIDENT S99-00242
 LOCATION Manitowoc - WB on USH 10

6. NAME - LAST - FIRST - MI Anony. | 7. D.O.B.

8. ADDRESS | 9. TX-HOME

11. CITY STATE ZIP | 10. TX-BUSINESS

12. DETAILS
 Caller observed a vehicle being pulled on a trailer, possibly to salvage yard. It was blk + silver, had no hood, no grill, & no taillight covers. It was a chev pickup truck

11:30
 022699
 14. REC'D | 15. DISP | 16. 10-23 | 17. 10-24
 13. DAY
 SUN 1 THU 5
 MON 2 FR 6
 TUE 3 SAT 7
 WED 4

MANITOWOC COUNTY SHERIFF
 INCIDENT CARD

18. ASSIGNED
 MATSO 9129
 KALPER HVT

19. REC. BY 920 | 20. DIS. BY 1
 22. TYPE OF REPORT
 1. INCIDENT
 2. ACCIDENT
 3. CITATION
 4. NONE
 23. STATUS
 1. UNFOUNDED
 2. PNL
 3. OTHER
 4. CLEARED
 5. EXCEPT CLEARED
 24. DATE CLEARED 03/01/99
 25. OFFENSE TYPE
 1. ADULT NA
 2. JUVENILE
 3. UNKNOWN
 21A. M.O.

39. (CODE S-SUSPECT W-WITNESS V-VICTIM O-OTHER)				41. D.O.B.		42. ADDRESS		43. TELEPHONE	
CODE	40. NAME- LAST	FIRST	MI						
0	LAPALM	NORMAN E.		45953			HWY H RD Cato		

02-26-99 cont'd
 with headlights like the ones on vehicles in reward flyer. It had lots of damage. The vehicle towing was a red Ford or Dodge pickup, registration unk. This occurred approx. 1 hr. ago. Caller suggests checking Tisler Salvage and salvage yard in Brillion. Caller wished to remain anonymous. sbraun920

03/01/99 @ 0840 Hrs I Deputy E. Glaeser contacted personal at Tisler Salvage in Menchalsville ref this inc. NORMAN LAPALM told me he transported a vehicle picked up in the city of Manitowoc on friday the 26th of Feb. LAPALM did show me the truck in question and I can identify it as one from an earlier crime stoppers report that I personally investigated and eliminated the vehicle at that time. I was unable to read the VIN number off the brown and tan chev suburban but it had the engine removed and the party I spoke to on the previous complaint told me Tislars would be towing it. No further action needed. EJG

EJG
 KAS

45. IF COMPLAINANT DIFFERENT THEN CALLER, ENTER NAME, ADDRESS, D.O.B., TELEPHONE

46. IF CODE O (OTHER) IS USED IN FIELD #39, EXPLAIN.

INCIDENT REPORT: NOTE: IF SECTION 22 ABOVE HAS NUMBER 4 CHECKED, DO NOT GO BEYOND THIS LINE WITHOUT RECORDS SECTION BEING ADVISED. OR NO RECORD ENTRIES WILL BE MADE BELOW THIS LINE.

PROPERTY VALUE	26. PROPERTY	A. CURRENCY	B. JEWELRY	C. FURS CLOTHING	D. VEHICLE (LOCAL)	E. OFFICE EQUIPMENT	F. RADIO, TV CAMERAS	G. FIREARMS	H. HOUSE-HOLD GOODS
	STOLEN	\$	\$	\$	\$	\$	\$	\$	\$
	RECOVERED	\$	\$	\$	\$	\$	\$	\$	\$
	26. PROPERTY	I. CONSUMABLES	J. LIVESTOCK	K. DRUGS	L. MARINE ITEMS	M. CONSTRUCTION ITEMS	N. LAWN AND GARDEN	O. SPORTING GOODS	P. MISC BICYCLE
	STOLEN	\$	\$	\$	\$	\$	\$	\$	\$
	RECOVERED	\$	\$	\$	\$	\$	\$	\$	\$

27. PROPERTY RECOVERED: LOCALLY _____ OTHER JURISDICTION _____ (INSERT O OR L)

PROPERTY ITEMIZATION	PROPERTY STOLEN/RECOVERED ITEMIZATION, USE THE FOLLOWING FORMAT				
	28. QUANTITY	29. ARTICLE NAME	30. BRAND NAME	31. SERIAL NUMBER	
					S <input type="checkbox"/> R <input type="checkbox"/>
					S <input type="checkbox"/> R <input type="checkbox"/>
					S <input type="checkbox"/> R <input type="checkbox"/>
					S <input type="checkbox"/> R <input type="checkbox"/>
					S <input type="checkbox"/> R <input type="checkbox"/>

33. PROPERTY DAMAGE AMOUNT \$ _____

34. INSURANCE COMPANY _____

35. OFFICER ASSAULTED Y N

36. ARSON Y N

37. STRUCTURE CODE _____

38. DAMAGE \$ _____

47. CIB

ENTERED

CANCELLED

NCIC

OTHER BROADCAST

48. TOTAL AMOUNT PROPERTY STOLEN \$ _____

49. TOTAL AMOUNT PROPERTY RECOVERED \$ _____

50. IS REPORT CONTINUED? YES NO

51. CAUTION INDICATORS, ATLS ETC.

52. DATA PROCESS INFORMATION:

COMPUTER ENTERED

DATE

13.8.99

MICROFILM INDEXED

INITIAL

KS

IS CASE CLASSIFICATION CORRECT?
IF N HAS CORRECTION BEEN MADE?

Y N

53. FILE APPROVAL

BY

[Signature]

DATE

13.8.99

1. CASE # S99 No 01673 2. CLASSIFICATION 6301 3. CENSUS 70000

INCIDENT CS | S99-00242

INCIDENT LOCATION Sheboygan

6. NAME- LAST-FIRST-MI Anonymous (2) 7. D.O.B.

8. ADDRESS 9. TX-HOME

11. CITY STATE ZIP 10. TX-BUSINESS

12. DETAILS See Attached.

02/26/99 1405

MANITOWOC COUNTY SHERIFF INCIDENT CARD

18. ASSIGNED MTSO [Signature] 929

19. REC. BY 935 20. DIS. BY 22. TYPE OF REPORT
 INCIDENT
 ACCIDENT
 CITATION
 NONE

21. HOW REC'D.
 911
 POLICE RADIO
 PHONE
 TTY
 IN PERSON
 ON VIEW
 OFF. OFF DUTY
 C.B. RADIO
 OTHER

23. STATUS
 UNFOUNDED
 PNL
 OTHER
 CLEARED
 EXCEPT CLEARED

24. DATE CLEARED 03/08/99

25. OFFENSE TYPE
 ADULT
 JUVENILE
 UNKNOWN

13. DAY
 SUN 1 THU 5
 MON 2 **FRI 6**
 TUE 3 SAT 7
 WED 4

39. (CODE S-SUSPECT W-WITNESS V-VICTIM O-OTHER)				41. D.O.B.		42. ADDRESS		43. TELEPHONE	
CODE	40. NAME-LAST	FIRST	MI						
0	Wencka, Grace A.						Grignon Rd., Winneconne		

02/26/99 1840hrs Attempted contact with complainant to varify the year of the vehicle. The 10-28 comes back to a 94 Chev truck. Does not fit description of suspect vehicle. Close out: M.J. Bushman [Signature]
 Wencka's number non published.

45. IF COMPLAINANT DIFFERENT THEN CALLER, ENTER NAME, ADDRESS, D.O.B., TELEPHONE.

46. IF CODE O (OTHER) IS USED IN FIELD #39, EXPLAIN.

INCIDENT REPORT: NOTE: IF SECTION 22 ABOVE HAS NUMBER 4 CHECKED, DO NOT GO BEYOND THIS LINE WITHOUT RECORDS SECTION BEING ADVISED, OR NO RECORD ENTRIES WILL BE MADE BELOW THIS LINE.

PROPERTY VALUE	26. PROPERTY	A. CURRENCY	B. JEWELRY	C. FURS CLOTHING	D. VEHICLE (LOCAL)	E. OFFICE EQUIPMENT	F. RADIO, TV CAMERAS	G. FIREARMS	H. HOUSE-HOLD GOODS
	STOLEN	\$	\$	\$	\$	\$	\$	\$	\$
	RECOVERED	\$	\$	\$	\$	\$	\$	\$	\$
	26. PROPERTY	I. CONSUMABLES	J. LIVESTOCK	K. DRUGS	L. MARINE ITEMS	M. CONSTRUCTION ITEMS	N. LAWN AND GARDEN	O. SPORTING GOODS	P. MISC BICYCLE
STOLEN	\$	\$	\$	\$	\$	\$	\$	\$	
RECOVERED	\$	\$	\$	\$	\$	\$	\$	\$	

27. PROPERTY RECOVERED: LOCALLY _____ OTHER JURISDICTION _____ (INSERT O OR L)

PROPERTY ITEMIZATION	PROPERTY STOLEN/RECOVERED ITEMIZATION, USE THE FOLLOWING FORMAT				
	28. QUANTITY	29. ARTICLE NAME	30. BRAND NAME	31. SERIAL NUMBER	32. CODE
					S <input type="checkbox"/> R <input type="checkbox"/>
					S <input type="checkbox"/> R <input type="checkbox"/>
					S <input type="checkbox"/> R <input type="checkbox"/>
					S <input type="checkbox"/> R <input type="checkbox"/>
					S <input type="checkbox"/> R <input type="checkbox"/>

33. PROPERTY DAMAGE AMOUNT \$ _____

34. INSURANCE COMPANY _____

35. OFFICER ASSAULTED Y N

36. ARSON Y N

37. STRUCTURE CODE _____

38. DAMAGE \$ _____

47. CIB ENTERED CANCELLED
 NCIC
 OTHER BROADCAST

48. TOTAL AMOUNT PROPERTY STOLEN \$ _____

49. TOTAL AMOUNT PROPERTY RECOVERED \$ _____

50. IS REPORT CONTINUED? YES NO

51. CAUTION INDICATORS, ATLS ETC.

52. DATA PROCESS INFORMATION:

COMPUTER ENTERED DATE 5/5/99
 MICROFILM INDEXED INITIAL AS

53. FILE APPROVAL

IS CASE CLASSIFICATION CORRECT? N
 IF N HAS CORRECTION BEEN MADE? N

BY [Signature] DATE 03/08/99

1. CASE # S99 No 01686
 2. CLASSIFICATION 631011
 3. CENSUS 701000

MANITOWOC COUNTY SHERIFF
 INCIDENT CARD

4. INCIDENT 188 S99-00242
 5. LOCATION Appleton

18. ASSIGNED MSO 9129
 Raube 410

6. NAME - LAST-FIRST-MI Anonymous
 7. D.O.B.

8. ADDRESS
 9. TX-HOME

19. REC. BY 935
 20. DIS. BY
 22. TYPE OF REPORT
 1. INCIDENT
 2. ACCIDENT
 3. CITATION
 4. NONE

11. CITY STATE ZIP
 10. TX-BUSINESS

21. HOW REC'D.
 1. 911
 2. POLICE RADIO
 3. PHONE
 4. TTY
 5. IN PERSON
 6. ON VIEW
 7. OFF. OFF DUTY
 8. C.B. RADIO
 9. OTHER
 23. STATUS
 1. UNFOUNDED
 2. PNL
 3. OTHER
 4. CLEARED
 5. EXCEPT CLEARED

12. DETAILS See Attached

5591
 6/26/99 1655

14. REC'D
 15. DISP
 16. 10-23
 17. 10-24
 13. DAY
 SUN 1 THU 5
 MON 2 FRI 6
 TUE 3 SAT 7
 WED 4

24. DATE CLEARED 031899
 25. OFFENSE TYPE
 1. ADULT
 2. JUVENILE
 3. UNKNOWN
 NA

39. (CODE S-SUSPECT W-WITNESS V-VICTIM O-OTHER)	40. NAME-LAST	FIRST	MI	41. D.O.B.	42. ADDRESS	43. TELEPHONE
O	Terry, Stephen	P.	176288		W. Spemcer St. Appleton	

02-27-99- Information recieved on this complaint is not consistent with the vehicle we are looking for. It is a 1996 Chev. Closed out CJRaube

CASE # S99 No 0168

45. IF COMPLAINANT DIFFERENT THEN CALLER, ENTER NAME, ADDRESS, D.O.B., TELEPHONE.

46. IF CODE O (OTHER) IS USED IN FIELD #39, EXPLAIN.

INCIDENT REPORT: NOTE: IF SECTION 22 ABOVE HAS NUMBER 4 CHECKED, DO NOT GO BEYOND THIS LINE WITHOUT RECORDS SECTION BEING ADVISED, OR NO RECORD ENTRIES WILL BE MADE BELOW THIS LINE.

PROPERTY VALUE	26. PROPERTY	A. CURRENCY	B. JEWELRY	C. FURS CLOTHING	D. VEHICLE (LOCAL)	E. OFFICE EQUIPMENT	F. RADIO, TV CAMERAS	G. FIREARMS	H. HOUSE-HOLD GOODS
	STOLEN	\$	\$	\$	\$	\$	\$	\$	\$
	RECOVERED	\$	\$	\$	\$	\$	\$	\$	\$
	26. PROPERTY	I. CONSUMABLES	J. LIVESTOCK	K. DRUGS	L. MARINE ITEMS	M. CONSTRUCTION ITEMS	N. LAWN AND GARDEN	O. SPORTING GOODS	P. MISC BICYCLE
STOLEN	\$	\$	\$	\$	\$	\$	\$	\$	
RECOVERED	\$	\$	\$	\$	\$	\$	\$	\$	

27. PROPERTY RECOVERED: LOCALLY _____ OTHER JURISDICTION _____ (INSERT O OR L)

PROPERTY ITEMIZATION	28. QUANTITY	29. ARTICLE NAME	30. BRAND NAME	31. SERIAL NUMBER	32. CODE
					S R <input type="checkbox"/> <input type="checkbox"/>
					S R <input type="checkbox"/> <input type="checkbox"/>
					S R <input type="checkbox"/> <input type="checkbox"/>
					S R <input type="checkbox"/> <input type="checkbox"/>
					S R <input type="checkbox"/> <input type="checkbox"/>
					S R <input type="checkbox"/> <input type="checkbox"/>

33. PROPERTY DAMAGE AMOUNT \$ _____

34. INSURANCE COMPANY _____

35. OFFICER ASSAULTED Y N

36. ARSON Y N

37. STRUCTURE CODE _____

38. DAMAGE \$ _____

47. CIB	ENTERED <input type="checkbox"/>	CANCELLED <input type="checkbox"/>
NCIC	<input type="checkbox"/>	<input type="checkbox"/>
OTHER BROADCAST	<input type="checkbox"/>	<input type="checkbox"/>

48. TOTAL AMOUNT PROPERTY STOLEN \$ _____

49. TOTAL AMOUNT PROPERTY RECOVERED \$ _____

50. IS REPORT CONTINUED? YES NO

51. CAUTION INDICATORS, ATLS ETC.

52. DATA PROCESS INFORMATION:

COMPUTER ENTERED DATE 3.8.99
 MICROFILM INDEXED INITIAL KS

53. FILE APPROVAL

IS CASE CLASSIFICATION CORRECT? Y N
 IF N HAS CORRECTION BEEN MADE? Y N

BY [Signature] DATE 3.8.99

5. INCIDENT LOCATION

Kohler Company parking lot

MTSD 929

6. NAME- LAST-FIRST-MI

Anonymous

7. D.O.B.

8. ADDRESS

9. TX-HOME

11. CITY

STATE ZIP

10. TX-BUSINESS

7. DETAILS

Comp. reports a Chev 84-86 blue with paint chipping off + black primer showing through is parked daily in supervisor's area at Kohler Company RP# BA81416 with grill missing on passenger side.

02-22-99

19. REC. BY 923 20. DIS. BY 923

22. TYPE OF REPORT

- 1. INCIDENT
- 2. ACCIDENT
- 3. CITATION
- 4. NONE

21. HOW REC'D.

- 1. 911
- 2. POLICE RADIO
- 3. PHONE
- 4. TTY
- 5. IN PERSON
- 6. ON VIEW
- 7. OFF. OFF DUTY
- 8. C.B. RADIO
- 9. OTHER

23. STATUS

- 1. UNFOUNDED
- 2. PNL
- 3. OTHER
- 4. CLEARED
- 5. EXCEPT CLEARED

24. DATE CLEARED

02 08 99

25. OFFENSE TYPE

- 1. ADULT
- 2. JUVENILE
- 3. UNKNOWN
- NA

14. REC'D 15. DISP 16. 10-23 17. 10-24

13. DAY

SUN 1 THU 5
MON 2 FRI 6
TUE 3 SAT 7
WED 4

21A. M.O.

|||||

39. (CODE S-SUSPECT W-WITNESS V-VICTIM O-OTHER)

CODE	40. NAME-LAST	FIRST	MI	41. D.O.B.	42. ADDRESS	43. TELEPHONE
O	Rotter Terrence M.			90329	Hwy 32 Sheboygan	

02/23/99 Contact made with Kohler PD, Off. Brogni and request made to make contact at Kohler Company parking area for suspicious vehicle. He advised Kohler Co. has their own security, however he would assist in checking for the vehicle. It is late afternoon and quite possible the vehicle has already left. He will check now and 02/24/99 and get back to me with followup. M.J. Bushman

1845hrs Call back Off. Brogni stated they missed the vehicle today, followup will take place 02/24/99 subject works 9-5. Fax number given to sent followup report. M.J. Bushman

02/24/99 0905hrs Dispatcher took a call from Kohler Police Chief stating they checked the pickup truck in question. It does have part of the grille on the passenger side missing, no other obvious damage. There was a small area of blue paint transfer on passenger door. Not the suspect vehicle, close complaint. M.J. Bushman

599 IN 01334

45. IF COMPLAINANT DIFFERENT THEN CALLER, ENTER NAME, ADDRESS, D.O.B., TELEPHONE.

46. IF CODE O (OTHER) IS USED IN FIELD #39, EXPLAIN.

INCIDENT REPORT: NOTE: IF SECTION 22 ABOVE HAS NUMBER 4 CHECKED, DO NOT GO BEYOND THIS LINE WITHOUT RECORDS SECTION BEING ADVISED, OR NO RECORD ENTRIES WILL BE MADE BELOW THIS LINE.

PROPERTY VALUE	26. PROPERTY	A. CURRENCY	B. JEWELRY	C. FURS CLOTHING	D. VEHICLE (LOCAL)	E. OFFICE EQUIPMENT	F. RADIO, TV CAMERAS	G. FIREARMS	H. HOUSE-HOLD GOODS
	STOLEN	\$	\$	\$	\$	\$	\$	\$	\$
	RECOVERED	\$	\$	\$	\$	\$	\$	\$	\$
	26. PROPERTY	I. CONSUMABLES	J. LIVESTOCK	K. DRUGS	L. MARINE ITEMS	M. CONSTRUCTION ITEMS	N. LAWN AND GARDEN	O. SPORTING GOODS	P. MISC BICYCLE
STOLEN	\$	\$	\$	\$	\$	\$	\$	\$	
RECOVERED	\$	\$	\$	\$	\$	\$	\$	\$	

27. PROPERTY RECOVERED: LOCALLY _____ OTHER JURISDICTION _____ (INSERT O OR L)

PROPERTY ITEMIZATION	PROPERTY STOLEN/RECOVERED ITEMIZATION, USE THE FOLLOWING FORMAT				
	28. QUANTITY	29. ARTICLE NAME	30. BRAND NAME	31. SERIAL NUMBER	32. CODE
					S R <input type="checkbox"/> <input type="checkbox"/>
					S R <input type="checkbox"/> <input type="checkbox"/>
					S R <input type="checkbox"/> <input type="checkbox"/>
					S R <input type="checkbox"/> <input type="checkbox"/>

33. PROPERTY DAMAGE AMOUNT \$ _____

34. INSURANCE COMPANY _____

35. OFFICER ASSAULTED Y N

36. ARSON Y N

37. STRUCTURE CODE _____

38. DAMAGE \$ _____

47. CIB ENTERED CANCELLED
 NCIC
 OTHER BROADCAST

48. TOTAL AMOUNT PROPERTY STOLEN \$ _____

49. TOTAL AMOUNT PROPERTY RECOVERED \$ _____

50. IS REPORT CONTINUED? YES NO

51. CAUTION INDICATORS, ATLS ETC.

52. DATA PROCESS INFORMATION:

COMPUTER ENTERED DATE 5/8/99
 MICROFILM INDEXED INITIAL AS

53. FILE APPROVAL

IS CASE CLASSIFICATION CORRECT? N
 IF N HAS CORRECTION BEEN MADE? N

BY [Signature] DATE 03/08/99

02/24/99

@ 0905

Mike -

[REDACTED]
Got a call from Kohler P.D. (the police chief)

he said the pick up in question

was checked & it does have part of the

grill on the passenger side missing - no

other obvious damage (a small area of

blue paint transfer on passenger door).

Call him if you have questions.

Jim L.

1. CASE # 2. CLASSIFICATION 3. CENSUS

S99 No 01543 63P.I., 1/4/00

4. INCIDENT

CS S99-00242

INCIDENT LOCATION

6. NAME - LAST - FIRST - MI

Anonymous

7. D.O.B.

8. ADDRESS

9. TX-HOME

11. CITY

STATE ZIP

10. TX-BUSINESS

12. DETAILS

See - Crime Stopper forms

02-23-99 0820

MANITOWOC COUNTY SHERIFF INCIDENT CARD

18. ASSIGNED

Lenk 2014 929

19. REC. BY 921

20. DIS. BY

22. TYPE OF REPORT

- 1. INCIDENT
- 2. ACCIDENT
- 3. CITATION
- 4. NONE

21. HOW REC'D.

- 1. 911
- 2. POLICE RADIO
- 3. PHONE
- 4. TTY
- 5. IN PERSON
- 6. ON VIEW
- 7. OFF. OFF DUTY
- 8. C.B. RADIO
- 9. OTHER

23. STATUS

- 1. UNFOUNDED
- 2. PNL
- 3. OTHER
- 4. CLEARED
- 5. EXCEPT CLEARED

24. DATE CLEARED

03/08/99

21A. M.O.

25. OFFENSE TYPE

- 1. ADULT NA
- 2. JUVENILE
- 3. UNKNOWN

14. REC'D	15. DISP	16. 10-23	17. 10-24
13. DAY			
SUN 1	THU 5		
MON 2	FRI 6		
TUE 3	SAT 7		
WED 4			

39. (CODE S-SUSPECT W-WITNESS V-VICTIM O-OTHER)

CODE	40. NAME - LAST	FIRST	MI	41. D.O.B.	42. ADDRESS	43. TELEPHONE

See page 66 of S99-00242. JMLenk /bjc

45. IF COMPLAINANT DIFFERENT THEN CALLER, ENTER NAME, ADDRESS, D.O.B., TELEPHONE.

46. IF CODE O (OTHER) IS USED IN FIELD #39, EXPLAIN.

INCIDENT REPORT: NOTE: IF SECTION 22 ABOVE HAS NUMBER 4 CHECKED, DO NOT GO BEYOND THIS LINE WITHOUT RECORDS SECTION BEING ADVISED, OR NO RECORD ENTRIES WILL BE MADE BELOW THIS LINE.

PROPERTY VALUE	26. PROPERTY	A. CURRENCY	B. JEWELRY	C. FURS CLOTHING	D. VEHICLE (LOCAL)	E. OFFICE EQUIPMENT	F. RADIO, TV CAMERAS	G. FIREARMS	H. HOUSEHOLD GOODS
	STOLEN	\$	\$	\$	\$	\$	\$	\$	\$
	RECOVERED	\$	\$	\$	\$	\$	\$	\$	\$
	26. PROPERTY	I. CONSUMABLES	J. LIVESTOCK	K. DRUGS	L. MARINE ITEMS	M. CONSTRUCTION ITEMS	N. LAWN AND GARDEN	O. SPORTING GOODS	P. MISC BICYCLE
	STOLEN	\$	\$	\$	\$	\$	\$	\$	\$
	RECOVERED	\$	\$	\$	\$	\$	\$	\$	\$

27. PROPERTY RECOVERED: LOCALLY _____ OTHER JURISDICTION _____ (INSERT O OR L)

PROPERTY ITEMIZATION	PROPERTY STOLEN/RECOVERED ITEMIZATION, USE THE FOLLOWING FORMAT				
	28. QUANTITY	29. ARTICLE NAME	30. BRAND NAME	31. SERIAL NUMBER	32. CODE
					S R <input type="checkbox"/> <input type="checkbox"/>
					S R <input type="checkbox"/> <input type="checkbox"/>
					S R <input type="checkbox"/> <input type="checkbox"/>
					S R <input type="checkbox"/> <input type="checkbox"/>

33. PROPERTY DAMAGE AMOUNT \$ _____ 34. INSURANCE COMPANY _____

35. OFFICER ASSAULTED Y N 36. ARSON Y N 37. STRUCTURE CODE _____ 38. DAMAGE \$ _____

47. CIB ENTERED CANCELLED
 NCIC
 OTHER BROADCAST

48. TOTAL AMOUNT PROPERTY STOLEN \$ _____
 49. TOTAL AMOUNT PROPERTY RECOVERED \$ _____

50. IS REPORT CONTINUED? YES NO

51. CAUTION INDICATORS, ATLS ETC.

52. DATA PROCESS INFORMATION:
 COMPUTER ENTERED DATE 3/8/99
 MICROFILM INDEXED INITIAL KS
 IS CASE CLASSIFICATION CORRECT? Y N
 IF N HAS CORRECTION BEEN MADE? N

53. FILE APPROVAL
 BY [Signature] DATE 03/08/99
 MCSD 028 1/91

1. CASE # S99 No 01545 2. CLASSIFICATION 630.11, 11.41002 3. CENSUS

4. INCIDENT CS 599-00242
5. INCIDENT LOCATION

6. NAME - LAST - FIRST - MI ANONYMOUS 7. D.O.B.

8. ADDRESS 9. TX-HOME

11. CITY STATE ZIP 10. TX-BUSINESS

12. DETAILS See attached

14. REC'D 15. DISP 16. 10-23 17. 10-24
13. DAY
SUN 1 THU 5
MON 2 FRI 6
TUE 3 SAT 7
WED 4

MANITOWOC COUNTY SHERIFF
INCIDENT CARD

18. ASSIGNED Lenk DPJ 929

19. REC. BY 924 20. DIS. BY

22. TYPE OF REPORT
1. INCIDENT
2. ACCIDENT
3. CITATION
4. NONE

21. HOW REC'D.
1. 911
2. POLICE RADIO
3. PHONE
4. TTY
5. IN PERSON
6. ON VIEW
7. OFF. OFF DUTY
8. C.B. RADIO
9. OTHER

23. STATUS
1. UNFOUNDED
2. PNL
3. OTHER
4. CLEARED
5. EXCEPT CLEARED

24. DATE CLEARED 03 18 1999

25. OFFENSE TYPE
1. ADULT NA
2. JUVENILE
3. UNKNOWN

39. (CODE S-SUSPECT W-WITNESS V-VICTIM O-OTHER)

CODE	40. NAME-LAST	FIRST	MI	41. D.O.B.	42. ADDRESS	43. TELEPHONE

See pages 63 (addition by Deputy Jost) and 64 (addition by Det. Sgt. Lenk) of S99-00242.

Awaiting contact from Det. Conat of WPSO. JMLenk /bjc

See page 68 of S99-00242. Report can be closed out. JMLenk /bjc

S99 No 01545

45. IF COMPLAINANT DIFFERENT THEN CALLER, ENTER NAME, ADDRESS, D.O.B., TELEPHONE.

46. IF CODE O (OTHER) IS USED IN FIELD #39, EXPLAIN.

INCIDENT REPORT: NOTE: IF SECTION 22 ABOVE HAS NUMBER 4 CHECKED, DO NOT GO BEYOND THIS LINE WITHOUT RECORDS SECTION BEING ADVISED, OR NO RECORD ENTRIES WILL BE MADE BELOW THIS LINE.

PROPERTY VALUE	26. PROPERTY	A. CURRENCY	B. JEWELRY	C. FURS CLOTHING	D. VEHICLE (LOCAL)	E. OFFICE EQUIPMENT	F. RADIO, TV CAMERAS	G. FIREARMS	H. HOUSE-HOLD GOODS
	STOLEN	\$	\$	\$	\$	\$	\$	\$	\$
	RECOVERED	\$	\$	\$	\$	\$	\$	\$	\$
	26. PROPERTY	I. CONSUMABLES	J. LIVESTOCK	K. DRUGS	L. MARINE ITEMS	M. CONSTRUCTION ITEMS	N. LAWN AND GARDEN	O. SPORTING GOODS	P. MISC BICYCLE
STOLEN	\$	\$	\$	\$	\$	\$	\$	\$	
RECOVERED	\$	\$	\$	\$	\$	\$	\$	\$	

27. PROPERTY RECOVERED: LOCALLY _____ OTHER JURISDICTION _____ (INSERT O OR L)

PROPERTY ITEMIZATION	PROPERTY STOLEN/RECOVERED ITEMIZATION, USE THE FOLLOWING FORMAT				
	28. QUANTITY	29. ARTICLE NAME	30. BRAND NAME	31. SERIAL NUMBER	32. CODE
					S R <input type="checkbox"/> <input type="checkbox"/>
					S R <input type="checkbox"/> <input type="checkbox"/>
					S R <input type="checkbox"/> <input type="checkbox"/>
					S R <input type="checkbox"/> <input type="checkbox"/>
					S R <input type="checkbox"/> <input type="checkbox"/>

33. PROPERTY DAMAGE AMOUNT \$ _____ 34. INSURANCE COMPANY _____

35. OFFICER ASSAULTED Y N 36. ARSON Y N 37. STRUCTURE CODE _____ 38. DAMAGE \$ _____

47. CIB	ENTERED <input type="checkbox"/>	CANCELLED <input type="checkbox"/>	48. TOTAL AMOUNT PROPERTY STOLEN \$ _____
NCIC	<input type="checkbox"/>	<input type="checkbox"/>	
OTHER BROADCAST	<input type="checkbox"/>	<input type="checkbox"/>	49. TOTAL AMOUNT PROPERTY RECOVERED \$ _____

50. IS REPORT CONTINUED? YES NO 51. CAUTION INDICATORS, ATLS ETC.

52. DATA PROCESS INFORMATION:

COMPUTER ENTERED DATE 3/8/99

MICROFILM INDEXED INITIAL AS

IS CASE CLASSIFICATION CORRECT? N
IF N HAS CORRECTION BEEN MADE? N

53. FILE APPROVAL

BY [Signature] DATE 03/09/99

599 IN 01500 1020, 11, 201000

INCIDENT CARD

4. INCIDENT
03 599-00242

5. INCIDENT LOCATION
Summit St.

6. NAME- LAST-FIRST-MI
ANONYMOUS

7. D.O.B.

8. ADDRESS

9. TX-HOME

11. CITY STATE ZIP

10. TX-BUSINESS

02/23/99 2200

18. ASSIGNED
ALL **981**
Glaser **4/17**
929

19. REC. BY
946

20. DIS. BY

22. TYPE OF REPORT
 1. INCIDENT
 2. ACCIDENT
 3. CITATION
 4. NONE

12. DETAILS
CALLER STATES PERSON AT ABOVE ADDRESS USED TO HAVE A TRUCK FITTING H&R DESCRIP. AROUND TIME OF H&R. IT DISAPPEARED SHORTLY AFTER.

14. REC'D
 15. DISP
 16. 10-23
 17. 10-24

13. DAY
 SUN 1 THU 5
 MON 2 FRI 6
 TUE 3 SAT 7
 WED 4

21. HOW REC'D.
 1. 911
 2. POLICE RADIO
 3. PHONE
 4. TTY
 5. IN PERSON
 6. ON VIEW
 7. OFF. OFF DUTY
 8. C.B. RADIO
 9. OTHER

23. STATUS
 1. UNFOUNDED
 2. PNL
 3. OTHER
 4. CLEARED
 5. EXCEPT CLEARED

24. DATE CLEARED
0308 99

25. OFFENSE TYPE
 1. ADULT NA
 2. JUVENILE
 3. UNKNOWN

39. (CODE S-SUSPECT W-WITNESS V-VICTIM O-OTHER)				41. D.O.B.		42. ADDRESS		43. TELEPHONE	
CODE	40. NAME-LAST	FIRST	MI						
0	ERRIHM JAMES	T	170232			Summit Street Manitowoc			

02/25/99 @ 0800 Hrs I Deputy E. Glaeser made contact at [redacted] Summit Street in city of Manitowoc ref. this complaint. JAMES ERRIHM told me he owns the residence and ERRIHM was advised of the complaint. Errthum stated he does not nor has he ever owned a truck, much less a truck that matches the hit and run vehicle. ERRIHM also stated that he was unaware we were looking for a hit and run vehicle and stated he has been out of town looking for work lately and didnt have much time to read the papers. ERRIHM was asked if he had any roomates or know of anyone who would have parked in front of his house. After thinking for some time ERRIHM said he did remember a truck parking in front of his house but he could not provide any details on it. He said actually the truck was regularly parked in front of his house but he had no idea who would have owned it. ERRIHM also was unable to give any description of the vehicle , not even a color or make. He said he just never paid attention to it. ERRIHM was informed it was hard for this officer to believe he could have a truck parked in front of his house and not pay any attention to it. ERRIHM said he had been working long hours at Zenith Sinered company and left early in the morning and got home late at night. He also was asked why he was currently unemployed and he said he and his supervisor did not get along so the company laid him off. ERRIHM could not provide any information on the vehicle from this report but did state the last time he remembers seeing the truck was just before Christmas. An Alpha check was run on ERRIHM and it indicated only one vehicle listed to ERRIHM, a 1988 Olds Cutlas....no trucks. No further action taken. EJC *ST*

599 IN 01565

45. IF COMPLAINANT DIFFERENT THEN CALLER, ENTER NAME, ADDRESS, D.O.B., TELEPHONE.

46. IF CODE O (OTHER) IS USED IN FIELD #39, EXPLAIN.

INCIDENT REPORT: NOTE: IF SECTION 22 ABOVE HAS NUMBER 4 CHECKED, DO NOT GO BEYOND THIS LINE WITHOUT RECORDS SECTION BEING ADVISED, OR NO RECORD ENTRIES WILL BE MADE BELOW THIS LINE.

PROPERTY VALUE	26. PROPERTY	A. CURRENCY	B. JEWELRY	C. FURS CLOTHING	D. VEHICLE (LOCAL)	E. OFFICE EQUIPMENT	F. RADIO, TV CAMERAS	G. FIREARMS	H. HOUSE-HOLD GOODS
	STOLEN	\$	\$	\$	\$	\$	\$	\$	\$
	RECOVERED	\$	\$	\$	\$	\$	\$	\$	\$
	26. PROPERTY	I. CONSUMABLES	J. LIVESTOCK	K. DRUGS	L. MARINE ITEMS	M. CONSTRUCTION ITEMS	N. LAWN AND GARDEN	O. SPORTING GOODS	P. MISC BICYCLE
	STOLEN	\$	\$	\$	\$	\$	\$	\$	\$
	RECOVERED	\$	\$	\$	\$	\$	\$	\$	\$

27. PROPERTY RECOVERED: LOCALLY _____ OTHER JURISDICTION _____ (INSERT O OR L)

PROPERTY ITEMIZATION	PROPERTY STOLEN/RECOVERED ITEMIZATION, USE THE FOLLOWING FORMAT				
	28. QUANTITY	29. ARTICLE NAME	30. BRAND NAME	31. SERIAL NUMBER	32. CODE
					S R <input type="checkbox"/> <input type="checkbox"/>
					S R <input type="checkbox"/> <input type="checkbox"/>
					S R <input type="checkbox"/> <input type="checkbox"/>
					S R <input type="checkbox"/> <input type="checkbox"/>
					S R <input type="checkbox"/> <input type="checkbox"/>

33. PROPERTY DAMAGE AMOUNT \$ _____ 34. INSURANCE COMPANY _____

35. OFFICER ASSAULTED Y N 36. ARSON Y N 37. STRUCTURE CODE _____ 38. DAMAGE \$ _____

47. CIB	ENTERED <input type="checkbox"/>	CANCELLED <input type="checkbox"/>	48. TOTAL AMOUNT PROPERTY STOLEN \$ _____
NCIC	<input type="checkbox"/>	<input type="checkbox"/>	
OTHER BROADCAST	<input type="checkbox"/>	<input type="checkbox"/>	
			49. TOTAL AMOUNT PROPERTY RECOVERED \$ _____

50. IS REPORT CONTINUED? YES NO 51. CAUTION INDICATORS, ATLS ETC.

52. DATA PROCESS INFORMATION:

COMPUTER ENTERED DATE 3/8/99

MICROFILM INDEXED INITIAL AS

IS CASE CLASSIFICATION CORRECT? IF N HAS CORRECTION BEEN MADE? Y N

53. FILE APPROVAL

BY [Signature] DATE 3/8/99

1. CASE # 899 No 01566 2. CLASSIFICATION 6301 3. CENSUS 7,0000

4. INCIDENT # 599-00242

5. INCIDENT LOCATION 57 PLYMOUTH

6. NAME LAST-FIRST MI [REDACTED] 7. D.O.B. [REDACTED]

8. ADDRESS [REDACTED] 9. TX-HOME [REDACTED]

11. CITY [REDACTED] STATE [REDACTED] ZIP [REDACTED] 10. TX-BUSINESS [REDACTED]

12. DETAILS
CALLER STATES SEEING VEH. FITTING
DESCRIP. OF FATAL H+R ON HWY
57 IN PLYMOUTH SOUTHBOUND
NEAR FLEET FARM

02/23/99 2220

14. REC'D 15. DISP 16. 10-23 17. 10-24
13. DAY
SUN 1 THU 5
MON 2 FRI 6
TUE 3 SAT 7
WED 4

MANITOWOC COUNTY SHERIFF INCIDENT CARD

18. ASSIGNED ALL 981
939
Kaexer 419

19. REC. BY 9476 20. DIS. BY

21. HOW REC'D.
1. 911
2. POLICE RADIO
3. PHONE
4. TTY
5. IN PERSON
6. ON VIEW
7. OFF. OFF DUTY
8. C.B. RADIO
9. OTHER

22. TYPE OF REPORT
1. INCIDENT
2. ACCIDENT
3. CITATION
4. NONE
23. STATUS
1. UNFOUNDED
2. PNL
3. OTHER
4. CLEARED
5. EXCEPT CLEARED
24. DATE CLEARED 02/23/99

25. OFFENSE TYPE
1. ADULT NA
2. JUVENILE
3. UNKNOWN

39. (CODE S-SUSPECT W-WITNESS V-VICTIM O-OTHER)						
CODE	40. NAME-LAST	FIRST	MI	41. D.O.B.	42. ADDRESS	43. TELEPHONE

02/24/99 0600 Hrs 417 Deemed not enough information of this report to do any follow up..no plate number..no action taken. EJJ ETC

45. IF COMPLAINANT DIFFERENT THEN CALLER, ENTER NAME, ADDRESS, D.O.B., TELEPHONE.

46. IF CODE O (OTHER) IS USED IN FIELD #39, EXPLAIN.

INCIDENT REPORT: NOTE: IF SECTION 22 ABOVE HAS NUMBER 4 CHECKED, DO NOT GO BEYOND THIS LINE WITHOUT RECORDS SECTION BEING ADVISED, OR NO RECORD ENTRIES WILL BE MADE BELOW THIS LINE.

PROPERTY VALUE	26. PROPERTY	A. CURRENCY	B. JEWELRY	C. FURS CLOTHING	D. VEHICLE (LOCAL)	E. OFFICE EQUIPMENT	F. RADIO, TV CAMERAS	G. FIREARMS	H. HOUSE-HOLD GOODS
	STOLEN	\$	\$	\$	\$	\$	\$	\$	\$
	RECOVERED	\$	\$	\$	\$	\$	\$	\$	\$
	26. PROPERTY	I. CONSUMABLES	J. LIVESTOCK	K. DRUGS	L. MARINE ITEMS	M. CONSTRUCTION ITEMS	N. LAWN AND GARDEN	O. SPORTING GOODS	P. MISC BICYCLE
STOLEN	\$	\$	\$	\$	\$	\$	\$	\$	
RECOVERED	\$	\$	\$	\$	\$	\$	\$	\$	

27. PROPERTY RECOVERED: LOCALLY _____ OTHER JURISDICTION _____ (INSERT O OR L)

PROPERTY ITEMIZATION	PROPERTY STOLEN/RECOVERED ITEMIZATION, USE THE FOLLOWING FORMAT			
	28. QUANTITY	29. ARTICLE NAME	30. BRAND NAME	31. SERIAL NUMBER
				S R <input type="checkbox"/> <input type="checkbox"/>
				S R <input type="checkbox"/> <input type="checkbox"/>
				S R <input type="checkbox"/> <input type="checkbox"/>
				S R <input type="checkbox"/> <input type="checkbox"/>

33. PROPERTY DAMAGE AMOUNT \$ _____

34. INSURANCE COMPANY _____

35. OFFICER ASSAULTED Y N

36. ARSON Y N

37. STRUCTURE CODE _____

38. DAMAGE \$ _____

47. CIB ENTERED CANCELLED
 NCIC
 OTHER BROADCAST

48. TOTAL AMOUNT PROPERTY STOLEN \$ _____

49. TOTAL AMOUNT PROPERTY RECOVERED \$ _____

50. IS REPORT CONTINUED? YES NO

51. CAUTION INDICATORS, ATLS ETC.

52. DATA PROCESS INFORMATION:

COMPUTER ENTERED DATE 3/8/99
 MICROFILM INDEXED INITIAL RS

IS CASE CLASSIFICATION CORRECT? N
 IF N HAS CORRECTION BEEN MADE? N

53. FILE APPROVAL

BY [Signature] DATE 03/08/99

999 No 01567 6301 60000

AGENT SA9-00242

5. INCIDENT LOCATION
CTH CR

6. NAME LAST-FIRST-MI [REDACTED] 7. D.O.B. [REDACTED]

8. ADDRESS [REDACTED] 9. TX-HOME [REDACTED]

11. CITY STATE ZIP
MANITOWOC WI 54220

10. TX-BUSINESS [REDACTED]

12. DETAILS
CALLER STATES SHE BELIEVES SUSPECT
COULD BE RICK ROHL ON CTH CR.
SEE ATTACHED FOR FURTHER INFO.

02/23/99 2243

INCIDENT CARD

18. ASSIGNED
ALL 98
989
Bushman HHI

19. REC. BY 946 20. DIS. BY

22. TYPE OF REPORT
1. INCIDENT
2. ACCIDENT
3. CITATION
4. NONE

21. HOW REC'D.
1. 911
2. POLICE RADIO
3. PHONE
4. TTY
5. IN PERSON
6. ON VIEW
7. OFF. OFF DUTY
8. C.B. RADIO
9. OTHER

23. STATUS
1. UNFOUNDED
2. PNL
3. OTHER
4. CLEARED
5. EXCEPT CLEARED

24. DATE CLEARED 03/08/99

25. OFFENSE TYPE
1. ADULT NA
2. JUVENILE
3. UNKNOWN

14. REC'D 15. DISP 16. 10-23 17. 10-24

13. DAY
SUN 1 THU 5
MON 2 FRI 6
TUE 3 SAT 7
WED 4

21A. M.O.

39. (CODE S-SUSPECT W-WITNESS V-VICTIM O-OTHER)				42. ADDRESS		43. TELEPHONE
CODE	40. NAME- LAST	FIRST	MI	41. D.O.B.		

02/24/99 1226hrs Contact made by phone with the complainant. She was present at the party where Rohl and friend were doing heavy drugs, and talking foolish. She does not trust him and feels he could be the type responsible for such an act. Nothing was said specifically about the incident or implied, only they talked about painting Rohl's van. I explained We have talked with Rohl and viewed all his vehicles, he is not a suspect at this time unless she can help me with specific details. She stated "No they didn't say anything like that, I just don't trust them." Close. M.J. Bushman

70010 IN REC

45. IF COMPLAINANT DIFFERENT THEN CALLER, ENTER NAME, ADDRESS, D.O.B., TELEPHONE.

46. IF CODE O (OTHER) IS USED IN FIELD #39, EXPLAIN.

INCIDENT REPORT: NOTE: IF SECTION 22 ABOVE HAS NUMBER 4 CHECKED, DO NOT GO BEYOND THIS LINE WITHOUT RECORDS SECTION BEING ADVISED, OR NO RECORD ENTRIES WILL BE MADE BELOW THIS LINE.

PROPERTY VALUE	26. PROPERTY	A. CURRENCY	B. JEWELRY	C. FURS CLOTHING	D. VEHICLE (LOCAL)	E. OFFICE EQUIPMENT	F. RADIO, TV CAMERAS	G. FIREARMS	H. HOUSE-HOLD GOODS
	STOLEN	\$	\$	\$	\$	\$	\$	\$	\$
	RECOVERED	\$	\$	\$	\$	\$	\$	\$	\$
	26. PROPERTY	I. CONSUMABLES	J. LIVESTOCK	K. DRUGS	L. MARINE ITEMS	M. CONSTRUCTION ITEMS	N. LAWN AND GARDEN	O. SPORTING GOODS	P. MISC BICYCLE
	STOLEN	\$	\$	\$	\$	\$	\$	\$	\$
	RECOVERED	\$	\$	\$	\$	\$	\$	\$	\$

27. PROPERTY RECOVERED: LOCALLY _____ OTHER JURISDICTION _____ (INSERT O OR L)

PROPERTY ITEMIZATION	PROPERTY STOLEN/RECOVERED ITEMIZATION, USE THE FOLLOWING FORMAT				
	28. QUANTITY	29. ARTICLE NAME	30. BRAND NAME	31. SERIAL NUMBER	32. CODE
					S R <input type="checkbox"/> <input type="checkbox"/>
					S R <input type="checkbox"/> <input type="checkbox"/>
					S R <input type="checkbox"/> <input type="checkbox"/>
					S R <input type="checkbox"/> <input type="checkbox"/>

33. PROPERTY DAMAGE AMOUNT \$ _____

34. INSURANCE COMPANY _____

35. OFFICER ASSAULTED Y N

36. ARSON Y N

37. STRUCTURE CODE _____

38. DAMAGE \$ _____

47. CIB

ENTERED

CANCELLED

NCIC

OTHER BROADCAST

48. TOTAL AMOUNT PROPERTY STOLEN \$ _____

49. TOTAL AMOUNT PROPERTY RECOVERED \$ _____

50. IS REPORT CONTINUED? YES NO

51. CAUTION INDICATORS, ATLS ETC.

52. DATA PROCESS INFORMATION:

COMPUTER ENTERED DATE 3/8/99

MICROFILM INDEXED INITIAL DS

IS CASE CLASSIFICATION CORRECT? IF N HAS CORRECTION BEEN MADE?

Y N
Y N

53. FILE APPROVAL

BY [Signature]

DATE 03/08/99

02/24/99-000702

5. INCIDENT LOCATION
 USH 151, s. side (east of CTH 5)

6. NAME- LAST- FIRST- MI
 [REDACTED]

7. D.O.B.
 [REDACTED]

8. ADDRESS
 [REDACTED]

9. TX-HOME
 [REDACTED]

11. CITY STATE ZIP
 [REDACTED]

10. TX-BUSINESS
 [REDACTED]

02/24/99 02
 02/24/99 02
 02/24/99 02

Klaeser 917
 917

12. DETAILS
 [REDACTED] has an older Chev pickup, grey (primer), approx '78 model. It hasn't been driven for a month or so. It's been pk'd against a shed/barn - unable to see grill.

14. REC'D	15. DISP	16. 10-23	17. 10-24
13. DAY			
SUN 1	THU 5		
MON 2	FRI 6		
TUE 3	SAT 7		
WEB 4			

19. REC. BY
 920

20. DIS. BY
 920

21. HOW REC'D.
 1. 911
 2. POLICE RADIO
 3. PHONE
 4. TTY
 5. IN PERSON
 6. ON VIEW
 7. OFF. OFF DUTY
 8. C.B. RADIO
 9. OTHER

22. TYPE OF REPORT
 1. INCIDENT
 2. ACCIDENT
 3. CITATION
 4. NONE

23. STATUS
 1. UNFOUNDED
 2. PNL
 3. OTHER
 4. CLEARED
 5. EXCEPT CLEARED

24. DATE CLEARED
 03/08/99

25. OFFENSE TYPE
 1. ADULT NA
 2. JUVENILE
 3. UNKNOWN

21A. M.O.
 [REDACTED]

39. (CODE S-SUSPECT W-WITNESS V-VICTIM O-OTHER)

CODE	40. NAME-LAST	FIRST	MI	41. D.O.B.	42. ADDRESS	43. TELEPHONE

02-24-99 The [REDACTED] name is DREWS. He's in his 40's, and is a known drunk. He has or had relatives that live close to CTH CR, in Clover. Caller doesn't want [REDACTED] to know he called.
 sbraun920

02/24/99 Deputy Luke Bushman assisted and checked this vehicle as he was in the area and he did observe the vehicle to be a 1978 Chev pickup with no front end damage. In speaking to the owner he stated the cam shaft was out on the truck and it did not run. This report needs no more follow up. EJC *etc*

45. IF COMPLAINANT DIFFERENT THEN CALLER, ENTER NAME, ADDRESS, D.O.B., TELEPHONE.

46. IF CODE O (OTHER) IS USED IN FIELD #39, EXPLAIN.

INCIDENT REPORT: NOTE: IF SECTION 22 ABOVE HAS NUMBER 4 CHECKED, DO NOT GO BEYOND THIS LINE WITHOUT RECORDS SECTION BEING ADVISED, OR NO RECORD ENTRIES WILL BE MADE BELOW THIS LINE.

P R O P E R T Y V A L U E	26. PROPERTY	A. CURRENCY	B. JEWELRY	C. FURS CLOTHING	D. VEHICLE (LOCAL)	E. OFFICE EQUIPMENT	F. RADIO, TV CAMERAS	G. FIREARMS	H. HOUSE-HOLD GOODS
	STOLEN	\$	\$	\$	\$	\$	\$	\$	\$
	RECOVERED	\$	\$	\$	\$	\$	\$	\$	\$
	26. PROPERTY	I. CONSUMABLES	J. LIVESTOCK	K. DRUGS	L. MARINE ITEMS	M. CONSTRUCTION ITEMS	N. LAWN AND GARDEN	O. SPORTING GOODS	P. MISC BICYCLE
STOLEN	\$	\$	\$	\$	\$	\$	\$	\$	
RECOVERED	\$	\$	\$	\$	\$	\$	\$	\$	

27. PROPERTY RECOVERED: LOCALLY _____ OTHER JURISDICTION _____ (INSERT O OR L)

P R O P E R T Y I T E M I Z A T I O N	PROPERTY STOLEN/RECOVERED ITEMIZATION, USE THE FOLLOWING FORMAT				
	28. QUANTITY	29. ARTICLE NAME	30. BRAND NAME	31. SERIAL NUMBER	32. CODE
					S R <input type="checkbox"/> <input type="checkbox"/>
					S R <input type="checkbox"/> <input type="checkbox"/>
					S R <input type="checkbox"/> <input type="checkbox"/>
					S R <input type="checkbox"/> <input type="checkbox"/>

33. PROPERTY DAMAGE AMOUNT \$ _____

34. INSURANCE COMPANY _____

35. OFFICER ASSAULTED Y N

36. ARSON Y N

37. STRUCTURE CODE _____

38. DAMAGE \$ _____

47. CIB
 ENTERED CANCELLED
 NCIC
 OTHER BROADCAST

48. TOTAL AMOUNT PROPERTY STOLEN \$ _____

49. TOTAL AMOUNT PROPERTY RECOVERED \$ _____

50. IS REPORT CONTINUED? YES NO

51. CAUTION INDICATORS, ATLS ETC.

52. DATA PROCESS INFORMATION:

COMPUTER ENTERED DATE 3/8/99

MICROFILM INDEXED INITIAL DS

IS CASE CLASSIFICATION CORRECT? Y N
 IF N HAS CORRECTION BEEN MADE? Y N

53. FILE APPROVAL

BY [Signature] DATE 3/8/99

S99 IN 01570 16310.11 1551900

INCIDENT CARD

4. INCIDENT
CS/S99-00242

5. INCIDENT LOCATION
Fox Hills

6. NAME - LAST - FIRST - MI
ANON.

7. D.O.B.

8. ADDRESS

9. TX-HOME

11. CITY STATE ZIP

10. TX-BUSINESS

12. DETAILS
Caller saw older

veh missing passenger

side grill pk'd near

Motel Sat. (2/20) eve.

022499 0657
022499 0659

18. ASSIGNED
Glaeser 3/17
929

19. REC. BY 920
20. DIS. BY 920

21. HOW REC'D.
1. 911
2. POLICE RADIO
3. PHONE
4. TTY
5. IN PERSON
6. ON VIEW
7. OFF. OFF DUTY
8. C.B. RADIO
9. OTHER

22. TYPE OF REPORT
1. INCIDENT
2. ACCIDENT
3. CITATION
4. NONE
23. STATUS
1. UNFOUNDED
2. PNL
3. OTHER
4. CLEARED
5. EXCEPT CLEARED

24. DATE CLEARED 03/08/99

25. OFFENSE TYPE
1. ADULT NA
2. JUVENILE
3. UNKNOWN

13. DAY
SUN 1 THU 5
MON 2 FRI 6
TUE 3 SAT 7
WED 4

39. (CODE S-SUSPECT W-WITNESS V-VICTIM O-OTHER)

CODE	40. NAME-LAST	FIRST	MI	41. D.O.B.	42. ADDRESS	43. TELEPHONE

02/24/99 0700 hrs...Deputy E. Glaeser determined there is not enough information to do any follow up on this report. No action taken. EJG etc

45. IF COMPLAINANT DIFFERENT THEN CALLER, ENTER NAME, ADDRESS, D.O.B., TELEPHONE.

46. IF CODE O (OTHER) IS USED IN FIELD #39, EXPLAIN.

INCIDENT REPORT: NOTE: IF SECTION 22 ABOVE HAS NUMBER 4 CHECKED, DO NOT GO BEYOND THIS LINE WITHOUT RECORDS SECTION BEING ADVISED, OR NO RECORD ENTRIES WILL BE MADE BELOW THIS LINE.

PROPERTY VALUE	26. PROPERTY	A. CURRENCY	B. JEWELRY	C. FURS CLOTHING	D. VEHICLE (LOCAL)	E. OFFICE EQUIPMENT	F. RADIO, TV CAMERAS	G. FIREARMS	H. HOUSE-HOLD GOODS
	STOLEN	\$	\$	\$	\$	\$	\$	\$	\$
	RECOVERED	\$	\$	\$	\$	\$	\$	\$	\$
	26. PROPERTY	I. CONSUMABLES	J. LIVESTOCK	K. DRUGS	L. MARINE ITEMS	M. CONSTRUCTION ITEMS	N. LAWN AND GARDEN	O. SPORTING GOODS	P. MISC BICYCLE
	STOLEN	\$	\$	\$	\$	\$	\$	\$	\$
	RECOVERED	\$	\$	\$	\$	\$	\$	\$	\$

27. PROPERTY RECOVERED: LOCALLY _____ OTHER JURISDICTION _____ (INSERT O OR L)

PROPERTY ITEMIZATION	PROPERTY STOLEN/RECOVERED ITEMIZATION, USE THE FOLLOWING FORMAT				
	28. QUANTITY	29. ARTICLE NAME	30. BRAND NAME	31. SERIAL NUMBER	32. CODE
					S R <input type="checkbox"/> <input type="checkbox"/>
					S R <input type="checkbox"/> <input type="checkbox"/>
					S R <input type="checkbox"/> <input type="checkbox"/>
					S R <input type="checkbox"/> <input type="checkbox"/>
					S R <input type="checkbox"/> <input type="checkbox"/>

33. PROPERTY DAMAGE AMOUNT \$ _____

34. INSURANCE COMPANY _____

35. OFFICER ASSAULTED Y N

36. ARSON Y N

37. STRUCTURE CODE _____

38. DAMAGE \$ _____

47. CIB ENTERED CANCELLED
 NCIC
 OTHER BROADCAST

48. TOTAL AMOUNT PROPERTY STOLEN \$ _____

49. TOTAL AMOUNT PROPERTY RECOVERED \$ _____

50. IS REPORT CONTINUED? YES NO

51. CAUTION INDICATORS, ATLS ETC.

52. DATA PROCESS INFORMATION:

COMPUTER ENTERED DATE 5/8/99

MICROFILM INDEXED INITIAL AS

IS CASE CLASSIFICATION CORRECT?
 IF N HAS CORRECTION BEEN MADE? Y N

53. FILE APPROVAL

BY [Signature]

DATE 03/08/99

1. CASE # **S99 No 01576** | 2. CLASSIFICATION **63101** | 3. CENSUS **581063**

4. INCIDENT **CS-S99-00242**

5. INCIDENT LOCATION **EB Silver Creek Rd**

6. NAME - LAST-FIRST-MI [REDACTED] | 7. D.O.B. [REDACTED]

8. ADDRESS [REDACTED] | 9. TX-HOME [REDACTED]

11. CITY **Newton** | STATE | ZIP | 10. TX-BUSINESS

12. DETAILS
Saw a blue chevy truck going east on silver creek rd sometime last week. Possibly from a farm on the roads

082499 0822

MANITOWOC COUNTY SHERIFF INCIDENT CARD

18. ASSIGNED **929**
Bushman HHV

19. REC. BY **944** | 20. DIS. BY **944** | 22. TYPE OF REPORT
 INCIDENT
 ACCIDENT
 OTHER

21. HOW REC'D.
 1. 911
 2. POLICE RADIO
 3. PHONE
 4. TTY
 5. IN PERSON
 6. ON VIEW
 7. OFF. OFF DUTY
 8. C.B. RADIO
 9. OTHER

24. DATE CLEARED **03/08/99**
 25. OFFENSE TYPE
 1. ADULT NA
 2. JUVENILE
 3. UNKNOWN

14. REC'D | 15. DISP | 16. 10-23 | 17. 10-24
 13. DAY
 SUN 1 THU 5
 MON 2 FRI 6
 TUE 3 SAT 7
 WED 4

39. (CODE S-SUSPECT W-WITNESS V-VICTIM O-OTHER)				42. ADDRESS		43. TELEPHONE
CODE	40. NAME-LAST	FIRST	MI	41. D.O.B.		

02/24/99 1210hrs The blue farm vehicle described above was used in week two of the investigation for photo's of the suspected vehicle. Registration [REDACTED] Farm lists to Richard T. Ratajczak farm at Silver Creek and So. 26th Street. Close M.J. Bushman

45. IF COMPLAINANT DIFFERENT THEN CALLER, ENTER NAME, ADDRESS, D.O.B., TELEPHONE.

46. IF CODE O (OTHER) IS USED IN FIELD #39, EXPLAIN.

INCIDENT REPORT: IF SECTION 22 ABOVE HAS NUMBER 4 CHECKED, DO NOT GO BEYOND THIS LINE WITHOUT RECORDS SECTION BEING ADVISED, OR NO RECORD ENTRIES WILL BE MADE BELOW THIS LINE.

PROPERTY VALUE	26. PROPERTY	A. CURRENCY	B. JEWELRY	C. FURS CLOTHING	D. VEHICLE (LOCAL)	E. OFFICE EQUIPMENT	F. RADIO, TV CAMERAS	G. FIREARMS	H. HOUSE-HOLD GOODS
	STOLEN	\$	\$	\$	\$	\$	\$	\$	\$
	RECOVERED	\$	\$	\$	\$	\$	\$	\$	\$
	26. PROPERTY	I. CONSUMABLES	J. LIVESTOCK	K. DRUGS	L. MARINE ITEMS	M. CONSTRUCTION ITEMS	N. LAWN AND GARDEN	O. SPORTING GOODS	P. MISC BICYCLE
	STOLEN	\$	\$	\$	\$	\$	\$	\$	\$
	RECOVERED	\$	\$	\$	\$	\$	\$	\$	\$

27. PROPERTY RECOVERED: LOCALLY ____ OTHER JURISDICTION ____ (INSERT O OR L)

PROPERTY ITEMIZATION	PROPERTY STOLEN/RECOVERED ITEMIZATION, USE THE FOLLOWING FORMAT				
	28. QUANTITY	29. ARTICLE NAME	30. BRAND NAME	31. SERIAL NUMBER	
					S R <input type="checkbox"/> <input type="checkbox"/>
					S R <input type="checkbox"/> <input type="checkbox"/>
					S R <input type="checkbox"/> <input type="checkbox"/>
					S R <input type="checkbox"/> <input type="checkbox"/>
					S R <input type="checkbox"/> <input type="checkbox"/>

33. PROPERTY DAMAGE AMOUNT \$ _____ 34. INSURANCE COMPANY _____

35. OFFICER ASSAULTED Y N 36. ARSON Y N 37. STRUCTURE CODE _____ 38. DAMAGE \$ _____

47. CIB	ENTERED <input type="checkbox"/>	CANCELLED <input type="checkbox"/>	48. TOTAL AMOUNT PROPERTY STOLEN \$ _____
NCIC	<input type="checkbox"/>	<input type="checkbox"/>	
OTHER BROADCAST	<input type="checkbox"/>	<input type="checkbox"/>	
			49. TOTAL AMOUNT PROPERTY RECOVERED \$ _____

50. IS REPORT CONTINUED? YES NO 51. CAUTION INDICATORS, ATLS ETC.

52. DATA PROCESS INFORMATION:

COMPUTER ENTERED DATE 13, 8 99

MICROFILM INDEXED INITIAL RS

IS CASE CLASSIFICATION CORRECT? Y N

IF N HAS CORRECTION BEEN MADE? Y N

53. FILE APPROVAL

BY [Signature] DATE 03/08/99

399 IV 01011 10211 10211

4. INCIDENT **CS-599-00242**

5. INCIDENT LOCATION **So. 19th Corner 19th + Columbus**

6. NAME, LAST, FIRST, MI **MT Officer Garber 887**

7. D.O.B.

8. ADDRESS

9. TX-HOME

11. CITY STATE ZIP

10. TX-BUSINESS

12. DETAILS
Saw Truck PXW757 Tan Color No Grill with a dented hood.

032499 0838

14. REC'D. 15. DISP 16. 10-23 17. 10-24

13. DAY
 SUN 1 THU 5
 MON 2 FRI 6
 TUE 3 SAT 7
 (WED 4)

INCIDENT CARD

18. ASSIGNED **Glaeser 929**

19. REC. BY **944** 20. DIS. BY **944**

22. TYPE OF REPORT
 1. INCIDENT
 2. ACCIDENT
 3. ...
 4. ...

21. HOW REC'D.
 1. 911
 2. POLICE RADIO
 3. PHONE
 4. TTY
 5. IN PERSON
 6. ON VIEW
 7. OFF. OFF DUTY
 8. C.B. RADIO
 9. OTHER

23. 1. UNDETERMINED
 2. PNL
 3. OTHER
 4. CLEARED
 5. EXCEPT CLEARED

24. DATE CLEARED **030899**

25. OFFENSE TYPE
 1. ADULT NA
 2. JUVENILE
 3. UNKNOWN

21A. M.O.

39. (CODE S-SUSPECT W-WITNESS V-VICTIM O-OTHER)						
CODE	40. NAME-LAST	FIRST	MI	41. D.O.B.	42. ADDRESS	43. TELEPHONE
0	GROELLE STEVEN	M	11/18		S 19th Street	

02/25/99 0850 hrs Deputy E. Glaeser contacted The resident at [redacted] S19th street and Steven Grolle was asked about the Tan Suburban parked in his driveway. Groelle said the truck below to Keith Wilhelm and Groelle was presently putting the motor from that truck into another Suburban also parked in his driveway. Groelle did allow me to inspect the parts (grill radiator and fan shroud) that he had removed from the truck that were laying in his garage. None of the items matched our suspect vehicle and are from a 1984 Suburban. Groelle did state that the suburban that he took the engine out of was to be picked up today and junked out by Tisler junkyard. EJJ

EJJ

599 No 01577

45. IF COMPLAINANT DIFFERENT THEN CALLER, ENTER NAME, ADDRESS, D.O.B., TELEPHONE.

46. IF CODE O (OTHER) IS USED IN FIELD #39, EXPLAIN.

INCIDENT REPORT NOTE: IF SECTION 22 ABOVE HAS NUMBER 4 CHECKED, DO NOT GO BEYOND THIS LINE WITHOUT RECORDS SECTION BEING ADVISED, OR NO RECORD ENTRIES WILL BE MADE BELOW THIS LINE.

PROPERTY VALUE	26. PROPERTY	A. CURRENCY	B. JEWELRY	C. FURS CLOTHING	D. VEHICLE (LOCAL)	E. OFFICE EQUIPMENT	F. RADIO, TV CAMERAS	G. FIREARMS	H. HOUSE-HOLD GOODS
	STOLEN	\$	\$	\$	\$	\$	\$	\$	\$
	RECOVERED	\$	\$	\$	\$	\$	\$	\$	\$
	26. PROPERTY	I. CONSUMABLES	J. LIVESTOCK	K. DRUGS	L. MARINE ITEMS	M. CONSTRUCTION ITEMS	N. LAWN AND GARDEN	O. SPORTING GOODS	P. MISC BICYCLE
	STOLEN	\$	\$	\$	\$	\$	\$	\$	\$
	RECOVERED	\$	\$	\$	\$	\$	\$	\$	\$

27. PROPERTY RECOVERED: LOCALLY _____ OTHER JURISDICTION _____ (INSERT O OR L)

PROPERTY ITEMIZATION	PROPERTY STOLEN/RECOVERED ITEMIZATION, USE THE FOLLOWING FORMAT				
	28. QUANTITY	29. ARTICLE NAME	30. BRAND NAME	31. SERIAL NUMBER	32. CODE
					S R <input type="checkbox"/> <input type="checkbox"/>
					S R <input type="checkbox"/> <input type="checkbox"/>
					S R <input type="checkbox"/> <input type="checkbox"/>
					S R <input type="checkbox"/> <input type="checkbox"/>
					S R <input type="checkbox"/> <input type="checkbox"/>

33. PROPERTY DAMAGE AMOUNT \$ _____ 34. INSURANCE COMPANY _____

35. OFFICER ASSAULTED Y N 36. ARSON Y N 37. STRUCTURE CODE _____ 38. DAMAGE \$ _____

47. CIB	ENTERED <input type="checkbox"/>	CANCELLED <input type="checkbox"/>	48. TOTAL AMOUNT PROPERTY STOLEN \$ _____
NCIC	<input type="checkbox"/>	<input type="checkbox"/>	
OTHER BROADCAST	<input type="checkbox"/>	<input type="checkbox"/>	
			49. TOTAL AMOUNT PROPERTY RECOVERED \$ _____

50. IS REPORT CONTINUED? YES NO 51. CAUTION INDICATORS, ATLS ETC.

52. DATA PROCESS INFORMATION:

COMPUTER ENTERED DATE 3/8/99

MICROFILM INDEXED INITIAL AS

IS CASE CLASSIFICATION CORRECT? IF N HAS CORRECTION BEEN MADE? Y N

53. FILE APPROVAL

BY [Signature] DATE 03/08/99

1. CASE #. **SP No 01588** 2. CLASSIFICATION 6,30,1 3. CENSUS 7,00,0,0

CS/99-00242

5. INCIDENT LOCATION
Oshkosh

6. NAME - LAST - FIRST - MI
Anon

7. D.O.B.

8. ADDRESS

9. TX-HOME

11. CITY

STATE ZIP

10. TX-BUSINESS

12. DETAILS

Vehicle observed in Oshkosh with grill broken out. Veh appeared to be a Chev S-10 or Smaller type Toyota with a cap.

See attached worksheet.

6315 224 99

14. REC'D	15. DISP	16. 10-23	17. 10-24
13. DAY			
SUN 1	THU 5		
MON 2	FRI 6		
TUE 3	SAT 7		
WED 4			

MANITOWOC COUNTY SHERIFF
INCIDENT CARD

18. ASSIGNED

441
929

19. REC. BY
926

20. DIS. BY

22. TYPE OF REPORT

- 1. INCIDENT
- 2. ACCIDENT
- 3. CITATION
- 4. NONE

21. HOW REC'D.

- 1. 911
- 2. POLICE RADIO
- 3. PHONE
- 4. TTY
- 5. IN PERSON
- 6. ON VIEW
- 7. OFF. OFF DUTY
- 8. C.B. RADIO
- 9. OTHER

23. STATUS

- 1. UNFOUNDED
- 2. PNL
- 3. OTHER
- 4. CLEARED
- 5. EXCEPT CLEARED

24. DATE

CLEARED 0308 99

21A. M.O.

25. OFFENSE TYPE

- 1. ADULT
- 2. JUVENILE
- 3. UNKNOWN
- NA

39. (CODE S-SUSPECT W-WITNESS V-VICTIM O-OTHER)

CODE	40. NAME - LAST	FIRST	MI	41. D.O.B.	42. ADDRESS	43. TELEPHONE

02/24/99 1541hrs Vehicle described does not fit the suspect vehicle involved in the incident. Close M.J. Bushman

PP 10 57

45. IF COMPLAINANT DIFFERENT THEN CALLER, ENTER NAME, ADDRESS, D.O.B., TELEPHONE.

46. IF CODE O (OTHER) IS USED IN FIELD #39, EXPLAIN.

INCIDENT REPORT: NOTE: IF SECTION 22 ABOVE HAS NUMBER 4 CHECKED, DO NOT GO BEYOND THIS LINE WITHOUT RECORDS SECTION BEING ADVISED, OR NO RECORD ENTRIES WILL BE MADE BELOW THIS LINE.

PROPERTY VALUE	26. PROPERTY	A. CURRENCY	B. JEWELRY	C. FURS CLOTHING	D. VEHICLE (LOCAL)	E. OFFICE EQUIPMENT	F. RADIO, TV CAMERAS	G. FIREARMS	H. HOUSE-HOLD GOODS
	STOLEN	\$	\$	\$	\$	\$	\$	\$	\$
	RECOVERED	\$	\$	\$	\$	\$	\$	\$	\$
	26. PROPERTY	I. CONSUM-ABLES	J. LIVESTOCK	K. DRUGS	L. MARINE ITEMS	M. CONSTRUCTION ITEMS	N. LAWN AND GARDEN	O. SPORTING GOODS	P. MISC BICYCLE
STOLEN	\$	\$	\$	\$	\$	\$	\$	\$	
RECOVERED	\$	\$	\$	\$	\$	\$	\$	\$	

27. PROPERTY RECOVERED: LOCALLY _____ OTHER JURISDICTION _____ (INSERT O OR L)

PROPERTY ITEMIZATION	PROPERTY STOLEN/RECOVERED ITEMIZATION, USE THE FOLLOWING FORMAT				
	28. QUANTITY	29. ARTICLE NAME	30. BRAND NAME	31. SERIAL NUMBER	32. CODE
					S <input type="checkbox"/> R <input type="checkbox"/>
					S <input type="checkbox"/> R <input type="checkbox"/>
					S <input type="checkbox"/> R <input type="checkbox"/>
					S <input type="checkbox"/> R <input type="checkbox"/>

33. PROPERTY DAMAGE AMOUNT \$ _____ 34. INSURANCE COMPANY _____

35. OFFICER ASSAULTED Y N 36. ARSON Y N 37. STRUCTURE CODE _____ 38. DAMAGE \$ _____

47. CIB	ENTERED <input type="checkbox"/>	CANCELLED <input type="checkbox"/>	48. TOTAL AMOUNT PROPERTY STOLEN \$ _____
NCIC	<input type="checkbox"/>	<input type="checkbox"/>	
OTHER BROADCAST	<input type="checkbox"/>	<input type="checkbox"/>	

49. TOTAL AMOUNT PROPERTY RECOVERED \$ _____

50. IS REPORT CONTINUED? YES NO 51. CAUTION INDICATORS, ATLS ETC.

52. DATA PROCESS INFORMATION:

COMPUTER ENTERED DATE 3/8/99

MICROFILM INDEXED INITIAL AS

IS CASE CLASSIFICATION CORRECT? Y N
IF N HAS CORRECTION BEEN MADE? Y N

53. FILE APPROVAL
BY [Signature] DATE 03/08/99

S99 No 01605 1631011 152000

4. INCIDENT: CS / 599-00242

LOCATION: IGA on Menasha Ave

ADDRESS: [REDACTED]

8. TX-BUSINESS: [REDACTED]

11. CITY: Mtwa STATE: WI ZIP: [REDACTED]

12. DETAILS: Observed a veh in IGA
Pkg dot in Mtwa See attached

REC'D 2349 16:20
DISP 11 16:27

INCIDENT CARD

18. ASSIGNED: Bushman 929
HHH

19. REC. BY: 926
20. DIS. BY:

21. HOW REC'D:
1. 911
2. POLICE RADIO
3. PHONE
4. TTY
5. IN PERSON
6. ON VIEW
7. OFF. OFF DUTY
8. C.B. RADIO
9. OTHER

22. TYPE OF REPORT:
1. INCIDENT
2. ACCIDENT
3. CITATION
4. NONE
23. STATUS:
1. UNFOUNDED
2. PNL
3. OTHER
4. CLEARED
5. EXCEPT CLEARED
24. DATE CLEARED: 03/18/99
25. OFFENSE TYPE:
1. ADULT NA
2. JUVENILE
3. UNKNOWN

39. (CODE S-SUSPECT W-WITNESS V-VICTIM O-OTHER)

CODE	40. NAME-LAST	FIRST	MI	41. D.O.B.	42. ADDRESS	43. TELEPHONE

02/24/99 1642hrs Registration BH 73-950 not available now as DOT is down. Off. Thom from City PD was available and checked vehicle. Damage sounded possible as suspect vehicle and Officer waited at my request for driver. Driver Chris Wallander arrived advising the damage was from a car vs deer approximately one year ago. Name was recognizable and varified through FBI Rapid Start program this vehicle had been checked in the past several times. Close complaint. M.J. Bushman

MJB

45. IF COMPLAINANT DIFFERENT THEN CALLER, ENTER NAME, ADDRESS, D.O.B., TELEPHONE.

46. IF CODE O (OTHER) IS USED IN FIELD #39, EXPLAIN.

INCIDENT REPORT: NOTE: IF SECTION 22 ABOVE HAS NUMBER 4 CHECKED, DO NOT GO BEYOND THIS LINE WITHOUT RECORDS SECTION BEING ADVISED, OR NO RECORD ENTRIES WILL BE MADE BELOW THIS LINE.

PROPERTY VALUE	26. PROPERTY	A. CURRENCY	B. JEWELRY	C. FURS CLOTHING	D. VEHICLE (LOCAL)	E. OFFICE EQUIPMENT	F. RADIO, TV CAMERAS	G. FIREARMS	H. HOUSE-HOLD GOODS
	STOLEN	\$	\$	\$	\$	\$	\$	\$	\$
	RECOVERED	\$	\$	\$	\$	\$	\$	\$	\$
	26. PROPERTY	I. CONSUMABLES	J. LIVESTOCK	K. DRUGS	L. MARINE ITEMS	M. CONSTRUCTION ITEMS	N. LAWN AND GARDEN	O. SPORTING GOODS	P. MISC BICYCLE
STOLEN	\$	\$	\$	\$	\$	\$	\$	\$	
RECOVERED	\$	\$	\$	\$	\$	\$	\$	\$	

27. PROPERTY RECOVERED: LOCALLY _____ OTHER JURISDICTION _____ (INSERT O OR L)

PROPERTY ITEMIZATION	PROPERTY STOLEN/RECOVERED ITEMIZATION. USE THE FOLLOWING FORMAT				
	28. QUANTITY	29. ARTICLE NAME	30. BRAND NAME	31. SERIAL NUMBER	32. CODE
					S R <input type="checkbox"/> <input type="checkbox"/>
					S R <input type="checkbox"/> <input type="checkbox"/>
					S R <input type="checkbox"/> <input type="checkbox"/>
					S R <input type="checkbox"/> <input type="checkbox"/>
					S R <input type="checkbox"/> <input type="checkbox"/>

33. PROPERTY DAMAGE AMOUNT \$ _____

34. INSURANCE COMPANY _____

35. OFFICER ASSAULTED Y N

36. ARSON Y N

37. STRUCTURE CODE _____

38. DAMAGE \$ _____

47. CIB ENTERED CANCELLED
 NCIC
 OTHER BROADCAST

48. TOTAL AMOUNT PROPERTY STOLEN \$ _____

49. TOTAL AMOUNT PROPERTY RECOVERED \$ _____

50. IS REPORT CONTINUED? YES NO

51. CAUTION INDICATORS, ATLS ETC.

52. DATA PROCESS INFORMATION:

COMPUTER ENTERED DATE 3/8/99
 MICROFILM INDEXED INITIAL KS

53. FILE APPROVAL

IS CASE CLASSIFICATION CORRECT? N
 IF N HAS CORRECTION BEEN MADE? N

BY [Signature] DATE 4/3/99

INCIDENT **CS** **S99-00242**

5. INCIDENT LOCATION

6. NAME - LAST-FIRST-MI **Anonymous** 7. D.O.B.

8. ADDRESS 9. TX-HOME

11. CITY STATE ZIP 10. TX-BUSINESS

12. DETAILS **see attached**

02/25/99 06:20
 5290 b/scheo

INCIDENT CARD

18. ASSIGNED **921**
O'Hearn HSB

19. REC. BY **921** 20. DIS. BY

21. HOW REC'D.
 1. 911
 2. POLICE RADIO
 3. PHONE
 4. TTY
 5. IN PERSON
 6. ON VIEW
 7. OFF. OFF DUTY
 8. C.B. RADIO
 9. OTHER

22. TYPE OF REPORT
 1. INCIDENT
 2. ACCIDENT
 3. CITATION
 4. NONE

23. STATUS
 1. UNFOUNDED
 2. PNL
 3. OTHER
 4. CLEARED
 5. EXCEPT CLEARED

24. DATE CLEARED **03/08/99**

25. OFFENSE TYPE
 1. ADULT NA
 2. JUVENILE
 3. UNKNOWN

21A. M.O.

14. REC'D	15. DISP	16. 10-23	17. 10-24
SUN 1	MON 2	TUE 3	WED 4
THU 5	FRI 6	SAT 7	

39. (CODE S-SUSPECT W-WITNESS V-VICTIM O-OTHER)				
CODE	40. NAME-LAST FIRST MI	41. D.O.B.	42. ADDRESS	43. TELEPHONE

02/25/99 @ 0950 hrs. Officer given this crime stoppers and at this time I contacted [redacted] Officer was advised complaintant wishes to remain Anonymous. [redacted] states that on this date at 0530 hours. she went to the Harbor Express a mini mart in the city of Kewaunee. (It is located on hwy 42) She saw a vehicle bearing license # BK 92768, parked in the parking lot. The vehicle is described as a Blue van and the license was from Wis. [redacted] states that she noticed that the drivers side (right) was damaged. This confused me as I read the Crime stoppers complaint and questioned [redacted] further, she stated that the damage to this van was on the passengers side of the vehicle.

She stated that the vehicle had right front (passenger) damage and that it looked new or fresh. The lights from the vehicle were intact. She stated that the grill was removed (taken off) and wire mesh had been placed there instead. She states it looks like a grate across it and it had been screwed on. She continued on and stated that what caused her to notice was that the passenger side damage had paint chipped away and there was no rust visible. She states it seems very new damage. No other data.

02/25/99 @ 1010 hrs. Spoke to an Officer with Kewaunee city PD. Advised him of what we have and he stated he is aware of the owner of this vehicle. He stated that the owner has been involved in two 10-50's recently but that he would again check the vehicle for our agency. I left our number and my name with him TKO/B

2/25/99 @ 1150 hrs. Kewaunee officer called and stated he looked at the vehicle and that the vehicle has been documented as having two 10-50's within the city limits and that he personally handled one of them. He did take photos of the van but believes that the damage has no relation to our H&R. This can be closed out. TKO

CASE #
 S99
 No
 01625

45. IF COMPLAINANT DIFFERENT THEN CALLER, ENTER NAME, ADDRESS, D.O.B., TELEPHONE.

46. IF CODE O (OTHER) IS USED IN FIELD #39, EXPLAIN.

INCIDENT REPORT: NOTE: IF SECTION 22 ABOVE HAS NUMBER 4 CHECKED, DO NOT GO BEYOND THIS LINE WITHOUT RECORDS SECTION BEING ADVISED, OR NO RECORD ENTRIES WILL BE MADE BELOW THIS LINE.

PROPERTY VALUE	26. PROPERTY	A. CURRENCY	B. JEWELRY	C. FURS CLOTHING	D. VEHICLE (LOCAL)	E. OFFICE EQUIPMENT	F. RADIO, TV CAMERAS	G. FIREARMS	H. HOUSE-HOLD GOODS
	STOLEN	\$	\$	\$	\$	\$	\$	\$	\$
	RECOVERED	\$	\$	\$	\$	\$	\$	\$	\$
	26. PROPERTY	I. CONSUMABLES	J. LIVESTOCK	K. DRUGS	L. MARINE ITEMS	M. CONSTRUCTION ITEMS	N. LAWN AND GARDEN	O. SPORTING GOODS	P. MISC BICYCLE
	STOLEN	\$	\$	\$	\$	\$	\$	\$	\$
	RECOVERED	\$	\$	\$	\$	\$	\$	\$	\$

27. PROPERTY RECOVERED: LOCALLY _____ OTHER JURISDICTION _____ (INSERT O OR L)

PROPERTY ITEMIZATION	PROPERTY STOLEN/RECOVERED ITEMIZATION, USE THE FOLLOWING FORMAT				
	28. QUANTITY	29. ARTICLE NAME	30. BRAND NAME	31. SERIAL NUMBER	
					S <input type="checkbox"/> R <input type="checkbox"/>
					S <input type="checkbox"/> R <input type="checkbox"/>
					S <input type="checkbox"/> R <input type="checkbox"/>
					S <input type="checkbox"/> R <input type="checkbox"/>

33. PROPERTY DAMAGE AMOUNT \$ _____ 34. INSURANCE COMPANY _____

35. OFFICER ASSAULTED Y N 36. ARSON Y N 37. STRUCTURE CODE _____ 38. DAMAGE \$ _____

47. CIB NCIC OTHER BROADCAST	ENTERED <input type="checkbox"/> <input type="checkbox"/> <input type="checkbox"/>	CANCELLED <input type="checkbox"/> <input type="checkbox"/> <input type="checkbox"/>	48. TOTAL AMOUNT PROPERTY STOLEN \$ _____
			49. TOTAL AMOUNT PROPERTY RECOVERED \$ _____

50. IS REPORT CONTINUED? YES NO
51. CAUTION INDICATORS, ATLS ETC.

52. DATA PROCESS INFORMATION

COMPUTER ENTERED DATE 13.0 99
MICROFILM INDEXED INITIAL KS

IS CASE CLASSIFICATION CORRECT?
IF N HAS CORRECTION BEEN MADE? Y N

53. FILE APPROVAL
BY [Signature] DATE 03 08 99

MCSO 028 1/91

1. CASE # S99 No 01628 2. CLASSIFICATION 631011 3. CENSUS 1141002

MANITOWOC COUNTY SHERIFF
INCIDENT CARD

4. INCIDENT CS 599-00242
5. INCIDENT LOCATION

18. ASSIGNED O'Neal 456
441
929

6. NAME - LAST - FIRST - MI Anonymous 7. D.O.B.

8. ADDRESS 9. TX-HOME

11. CITY STATE ZIP 10. TX-BUSINESS

19. REC. BY 20. DIS. BY 22. TYPE OF REPORT
921
① INCIDENT
2. ACCIDENT
3. CITATION
4. NONE

12. DETAILS see attached

14. REC'D 15. DISP 16. 10-23 17. 10-24

21. HOW REC'D.
1. 911
2. POLICE RADIO
3. PHONE
4. TTY
5. IN PERSON
6. ON VIEW
7. OFF. OFF DUTY
8. C.B. RADIO
9. OTHER
23. STATUS
1. UNFOUNDED
2. PNL
3. OTHER
4. CLEARED
5. EXCEPT CLEARED

13. DAY
SUN 1 THU 5
MON 2 FRI 6
TUE 3 SAT 7
WED 4

24. DATE CLEARED 03 08 99
25. OFFENSE TYPE
1. ADULT NA
2. JUVENILE
3. UNKNOWN

39. (CODE S-SUSPECT W-WITNESS V-VICTIM O-OTHER)				42. ADDRESS		43. TELEPHONE
CODE	40. NAME LAST	FIRST	MI	41. D.O.B.		
	Garlieb	Herbert	C.			

02/25/99 @ 0925 This Lt. called [redacted] who called in this crime stoppers. She stated that she wishes her name not be used nor that we tell anyone we contact where this information came from. (her number is [redacted]). She stated she was invited to a party, (she can't remember when the party was held). At the Bill and Dorothy [redacted] residence at [redacted] Hackmann rd. Mtwc. phone # [redacted] Dorothy later called [redacted] after the party (due to the fact that [redacted] could not attend) to tell her the party was fine. [redacted] states that Dorothy said the conversation turned to the H & R fatal and a man by the name of Herbert Garlieb (phone # [redacted]) was at the party and he stated that someone (identity unknown) told him that the owner and driver of the hit and run vehicle lives near the victim's residence, that he hid the truck and has already had someone fix it for him. [redacted] stated that the name of who told Herbert Garlieb this information was not mentioned. Also the name of the suspect driver was also not mentioned. I questioned [redacted] about the spelling of Herbert's name and phone number and she stated she received this from Dorothy [redacted]. This was all the information she had. TKO

2/25/99 @ 1020 hrs. This Lt. did call Herbert Garlieb at [redacted]. He and his wife were on the phone and seem somewhat elderly. The Garlieb's stated that they heard their story as a rumor. They were at the Earl Otto Tavern and that someone (they cannot remember who it was) stated that the suspect in this case lives near the victims residence. They stated they remember someone saying that it was a "neighbor", but cannot remember because it was a long time ago. I advised them if they remember to call me as soon as possible. TKO

02/25/99 1200hrs Call placed to Earl Otto and he was asked to talk with his bartenders to see if any of them have heard the information listed above. M.J. Bushman
03/02/99 No contact from Earl Otto, he stated he would call me if anything remembered by bartenders. Close pending contact. M.J. Bushman

CASE # S99 No 01628

45. IF COMPLAINANT DIFFERENT THEN CALLER, ENTER NAME, ADDRESS, D.O.B., TELEPHONE.

46. IF CODE O (OTHER) IS USED IN FIELD #39, EXPLAIN.

INCIDENT REPORT: NOTE: IF SECTION 22 ABOVE HAS NUMBER 4 CHECKED, DO NOT GO BEYOND THIS LINE WITHOUT RECORDS SECTION BEING ADVISED, OR NO RECORD ENTRIES WILL BE MADE BELOW THIS LINE.

PROPERTY VALUE	26. PROPERTY	A. CURRENCY	B. JEWELRY	C. FURS CLOTHING	D. VEHICLE (LOCAL)	E. OFFICE EQUIPMENT	F. RADIO, TV CAMERAS	G. FIREARMS	H. HOUSE-HOLD GOODS
	STOLEN	\$	\$	\$	\$	\$	\$	\$	\$
	RECOVERED	\$	\$	\$	\$	\$	\$	\$	\$
	26. PROPERTY	I. CONSUM-ABLES	J. LIVESTOCK	K. DRUGS	L. MARINE ITEMS	M. CONSTRUCTION ITEMS	N. LAWN AND GARDEN	O. SPORTING GOODS	P. MISC BICYCLE
STOLEN	\$	\$	\$	\$	\$	\$	\$	\$	
RECOVERED	\$	\$	\$	\$	\$	\$	\$	\$	

27. PROPERTY RECOVERED: LOCALLY _____ OTHER JURISDICTION _____ (INSERT O OR L)

PROPERTY ITEMIZATION	PROPERTY STOLEN/RECOVERED ITEMIZATION, USE THE FOLLOWING FORMAT				
	28. QUANTITY	29. ARTICLE NAME	30. BRAND NAME	31. SERIAL NUMBER	
					S <input type="checkbox"/> R <input type="checkbox"/>
					S <input type="checkbox"/> R <input type="checkbox"/>
					S <input type="checkbox"/> R <input type="checkbox"/>
					S <input type="checkbox"/> R <input type="checkbox"/>

33. PROPERTY DAMAGE AMOUNT: \$ _____

34. INSURANCE COMPANY: _____

35. OFFICER ASSAULTED Y N

36. ARSON Y N

37. STRUCTURE CODE _____

38. DAMAGE \$ 477

47. CIB ENTERED CANCELLED
 NCIC
 OTHER BROADCAST

48. TOTAL AMOUNT PROPERTY STOLEN \$ _____

49. TOTAL AMOUNT PROPERTY RECOVERED \$ _____

50. IS REPORT CONTINUED? YES NO

51. CAUTION INDICATORS, ATLS ETC.

52. DATA PROCESS INFORMATION:

COMPUTER ENTERED DATE 10.8.99

MICROFILM INDEXED INITIAL 92

IS CASE CLASSIFICATION CORRECT? IF N HAS CORRECTION BEEN MADE? Y N

FILE APPROVAL

BY [Signature]

DATE 10.8.99

INC 01000 16,310.11, 15,210.00

INCIDENT CARD

18. ASSIGNED Lt. Bushman 4441 Glaeser 4117 MITSU 9889	
19. REC. BY 941	20. DIS. BY
22. TYPE OF REPORT 1. INCIDENT 2. ACCIDENT 3. CITATION 4. NONE	
21. HOW REC'D. 1. 911 2. POLICE RADIO 3. PHONE 4. TTY 5. IN PERSON 6. ON VIEW 7. OFF. OFF DUTY 8. C.B. RADIO 9. OTHER	
23. STATUS 1. UNFOUNDED 2. PNL 3. OTHER 4. CLEARED 5. EXCEPT CLEARED	
24. DATE CLEARED 02/27/99	
25. OFFENSE TYPE 1. ADULT <input type="checkbox"/> NA <input type="checkbox"/> 2. JUVENILE <input type="checkbox"/> 3. UNKNOWN <input type="checkbox"/>	

0900
2-25-99

INCIDENT LOCATION
AWC

6. NAME: LAST-FIRST-MI
Anonymous (2)

7. D.O.B.

8. ADDRESS

9. TX-HOME

10. TX-BUSINESS

11. CITY STATE ZIP

12. DETAILS
Saw a possible suspect vehicle

14. REC'D
15. DISP
16. 10-23
17. 10-24

13. DAY
SUN 1 THU 5
MON 2 FRI 6
TUE 3 SAT 7
WED 4

39. (CODE S-SUSPECT W-WITNESS V-VICTIM O-OTHER)				41. D.O.B.		42. ADDRESS		43. TELEPHONE	
CODE	40. NAME-LAST	FIRST	MI						

02/25/99 1242hrs Report does not have enough information to followup on at this time. There have been several similar vehicles checked since the incident, this one was probably one of them. Close out. M.J. Bushman
 AJ 26267 Schema, Allen ██████ Newton Rd., Kiel 87 Chev 176281
 626517 Geiken, Mark R. ██████ STH 57 #98, Plymouth, Wi. 92 Chev trk 176133
 626751 Olm, William R. ██████ Center Rd., Cleveland 85 Chev 49355

02/27/99 @ 0400 Hrs.: I, Deputy E. Glaeser, was given this report by Lt. M. Bushman who requested I follow-up on the 3 vehicles listed.

02/27/99 @ 0635 Hrs.: RP of 626751 was located at the address of ██████ Center Rd, Cleveland. Upon inspection of the vehicle, the grill design was different than our suspect vehicle. The grill present on this vehicle did not have any damage.

02/27/99 @ 0740 Hrs.: WI truck RP of AJ26267 was located at ██████ Newton Rd, Kiel. It should be noted the vehicle was a tan Chevy S10 pickup.

02/27/99 @: Lt. Bushman indicated he checked the vehicle with RP 626517. The vehicle can also be eliminated.

No further action taken on this report. EJGlaeser

//bjc

CASE # S99 No 01630

45. IF COMPLAINANT DIFFERENT FROM CALLER, ENTER NAME, ADDRESS, D.O.B., TELEPHONE.

46. IF CODE O (OTHER) IS USED IN FIELD #39, EXPLAIN

INCIDENT REPORT: NOTE: IF SECTION 22 ABOVE HAS NUMBER 4 CHECKED, DO NOT GO BEYOND THIS LINE WITHOUT RECORDS SECTION BEING ADVISED, OR NO RECORD ENTRIES WILL BE MADE BELOW THIS LINE.

PROPERTY VALUE	26. PROPERTY	A. CURRENCY	B. JEWELRY	C. FURS CLOTHING	D. VEHICLE (LOCAL)	E. OFFICE EQUIPMENT	F. RADIO, TV CAMERAS	G. FIREARMS	H. HOUSEHOLD GOODS
	STOLEN	\$	\$	\$	\$	\$	\$	\$	\$
	RECOVERED	\$	\$	\$	\$	\$	\$	\$	\$
	26. PROPERTY	I. CONSUMABLES	J. LIVESTOCK	K. DRUGS	L. MARINE ITEMS	M. CONSTRUCTION ITEMS	N. LAWN AND GARDEN	O. SPORTING GOODS	P. MISC BICYCLE
STOLEN	\$	\$	\$	\$	\$	\$	\$	\$	
RECOVERED	\$	\$	\$	\$	\$	\$	\$	\$	

27. PROPERTY RECOVERED: LOCALLY _____ OTHER JURISDICTION _____ (INSERT O OR L)

PROPERTY ITEMIZATION	PROPERTY STOLEN/RECOVERED ITEMIZATION, USE THE FOLLOWING FORMAT				31. SERIAL NUMBER	32. CODE	
	28. QUANTITY	29. ARTICLE NAME	30. BRAND NAME			S	R
						<input type="checkbox"/>	<input type="checkbox"/>
						<input type="checkbox"/>	<input type="checkbox"/>
						<input type="checkbox"/>	<input type="checkbox"/>
						<input type="checkbox"/>	<input type="checkbox"/>
						<input type="checkbox"/>	<input type="checkbox"/>
						<input type="checkbox"/>	<input type="checkbox"/>

33. PROPERTY DAMAGE AMOUNT \$ _____ 34. INSURANCE COMPANY _____

35. OFFICER ASSAULTED Y N 36. ARSON Y N 37. STRUCTURE CODE _____ 38. DAMAGE \$ _____

47. CIB	ENTERED <input type="checkbox"/>	CANCELLED <input type="checkbox"/>	48. TOTAL AMOUNT PROPERTY STOLEN \$ _____
NCIC	<input type="checkbox"/>	<input type="checkbox"/>	
OTHER BROADCAST	<input type="checkbox"/>	<input type="checkbox"/>	
			49. TOTAL AMOUNT PROPERTY RECOVERED \$ _____

50. IS REPORT CONTINUED? YES NO 51. CAUTION INDICATORS, ATLS ETC.

52. DATA PROCESS INFORMATION:

COMPUTER ENTERED DATE 06/29/99
 MICROFILM INDEXED INITIAL ML FILE APPROVAL _____

IS CASE CLASSIFICATION CORRECT? Y N
 IF N HAS CORRECTION BEEN MADE? Y N
 DATE 06/29/99

1. CASE # S99 No 01707 | 2. CLASSIFICATION 6310.11 | 3. CENSUS 5.3100.12

4. INCIDENT Crimestopper / 899-0242

5. INCIDENT LOCATION [REDACTED]

6. NAME LAST, FIRST, MI [REDACTED] (2) | 7. D.O.B. [REDACTED]

8. ADDRESS [REDACTED] | 9. TX-HOME [REDACTED] | 10. TX-BUSINESS [REDACTED]

11. CITY [REDACTED] STATE [REDACTED] ZIP [REDACTED] | 12. DETAILS
 Caller saw vehicle. BRO/WHT
 Blue V RP AK 77739. Vehicle
 seen at least twice in short
 period of time, must be local.

657220
1204

14. REC'D	15. DISP	16. 10-23	17. 10-24
13. DAY			
SUN 1	THU 5		
MON 2	FRI 6		
TUE 3	SAT 7		
WED 4			

MANITOWOC COUNTY SHERIFF
INCIDENT CARD

18. ASSIGNED
 [Signature] 922
 [Signature] 449

19. REC. BY 922 | 20. DIS. BY 922

21. HOW RECD.
 1. 911
 2. POLICE RADIO
 3. PHONE C.S.
 4. TTY
 5. IN PERSON
 6. ON VIEW
 7. OFF. OFF DUTY
 8. C.B. RADIO
 9. OTHER

22. TYPE OF REPORT
 1. INCIDENT
 2. ACCIDENT
 3. CITATION
 4. NONE

23. STATUS
 1. UNFOUNDED
 2. PNL
 3. OTHER
 4. CLEARED
 5. EXCEPT CLEARED

24. DATE CLEARED 02/09/99

25. OFFENSE TYPE
 1. ADULT NA
 2. JUVENILE
 3. UNKNOWN

39. (CODE S-SUSPECT W-WITNESS V-VICTIM O-OTHER)				41. D.O.B.		42. ADDRESS		43. TELEPHONE	
CODE	40. NAME-LAST	FIRST	MI						

On 02-27-99 I, Deputy Jost, made contact with Mrs. Guehlstorf at [REDACTED] School St. in Two Rivers, reference this crimestoppers complaint. She advised her husband hit a deer a short time ago. I inspected the front of the Chevy S-10 truck and observed the vehicle nor the the damage matches our suspect vehicle. No follow-up needed. [Signature] JMJ

On 02-28-99 I, Deputy Jost, entered this information into the computer. [Signature] JMJ

45. IF COMPLETELY DIFFERENT THEN CALLER, ENTER NAME, ADDRESS, D.O.B., TELEPHONE.

46. IF CODE O (OTHER) IS USED IN FIELD #39, EXPLAIN.

INCIDENT REPORT: NOTE: IF SECTION 22 ABOVE HAS NUMBER 4 CHECKED, DO NOT GO BEYOND THIS LINE WITHOUT RECORDS SECTION BEING ADVISED, OR NO RECORD ENTRIES WILL BE MADE BELOW THIS LINE.

PROPERTY VALUE	26. PROPERTY	A. CURRENCY	B. JEWELRY	C. FURS CLOTHING	D. VEHICLE (LOCAL)	E. OFFICE EQUIPMENT	F. RADIO, TV CAMERAS	G. FIREARM	H. HOUSEHOLD GOODS
	STOLEN	\$	\$	\$	\$	\$	\$	\$	\$
	RECOVERED	\$	\$	\$	\$	\$	\$	\$	\$
	26. PROPERTY	I. CONSUMABLES	J. LIVESTOCK	K. DRUGS	L. MARINE ITEMS	M. CONSTRUCTION ITEMS	N. LAWN AND GARDEN	O. SPORTING GOODS	P. MISC BICYCLE
STOLEN	\$	\$	\$	\$	\$	\$	\$	\$	
RECOVERED	\$	\$	\$	\$	\$	\$	\$	\$	

27. PROPERTY RECOVERED: LOCALLY _____ OTHER JURISDICTION _____ (INSERT O OR L)

PROPERTY ITEMIZATION	PROPERTY STOLEN/RECOVERED ITEMIZATION, USE THE FOLLOWING FORMAT				
	28. QUANTITY	29. ARTICLE NAME	30. BRAND NAME	31. SERIAL NUMBER	32. CODE
					S R <input type="checkbox"/> <input type="checkbox"/>
					S R <input type="checkbox"/> <input type="checkbox"/>
					S R <input type="checkbox"/> <input type="checkbox"/>
					S R <input type="checkbox"/> <input type="checkbox"/>
					S R <input type="checkbox"/> <input type="checkbox"/>

33. PROPERTY DAMAGE AMOUNT \$ _____

34. INSURANCE COMPANY _____

35. OFFICER ASSAULTED Y N

36. ARSON Y N

37. STRUCTURE CODE _____

38. DAMAGE \$ _____

47. CIB ENTERED CANCELLED
 NCIC
 OTHER BROADCAST

48. TOTAL AMOUNT PROPERTY STOLEN \$ _____

49. TOTAL AMOUNT PROPERTY RECOVERED \$ _____

50. IS REPORT CONTINUED? YES NO

51. CAUTION INDICATORS, ATLS ETC.

52. DATA PROCESS INFORMATION:

COMPUTER ENTERED DATE 3/8/99

MICROFILM INDEXED INITIAL AS

IS CASE CLASSIFICATION CORRECT? N
 IF N HAS CORRECTION BEEN MADE? Y N

53. FILE APPROVAL

BY [Signature] DATE 3/8/99

1. CASE # S99 No 01723
 2. CLASSIFICATION 630.11
 3. CENSUS 60000

MANITOWOC COUNTY SHERIFF
 INCIDENT CARD

4. INCIDENT S99-00242
 5. INCIDENT LOCATION

18. ASSIGNED MTSU
 Jost
 9/21/99
 449

6. NAME- LAST-FIRST-MI Anonymus (2)
 7. D.O.B.

8. ADDRESS
 9. TX-HOME

19. REC. BY 935
 20. DIS. BY
 22. TYPE OF REPORT
 1. INCIDENT
 2. ACCIDENT
 3. CITATION
 4. NONE

11. CITY STATE ZIP
 10. TX-BUSINESS

12. DETAILS See Attached

21. HOW REC'D.
 1. 911
 2. POLICE RADIO
 3. PHONE
 4. TTY
 5. IN PERSON
 6. ON VIEW
 7. OFF. OFF DUTY
 8. C.B. RADIO
 9. OTHER
 23. STATUS
 1. UNFOUNDED
 2. PNL
 3. OTHER
 4. CLEARED
 5. EXCEPT CLEARED

14. REC'D
 15. DISP
 16. 10-23
 17. 10-24
 13. DAY
 SUN 1 THU 5
 MON 2 FRI 6
 TUE 3 SAT 7
 WED 4

24. DATE CLEARED 03 08 99
 25. OFFENSE TYPE
 1. ADULT NA
 2. JUVENILE
 3. UNKNOWN

39. (CODE S-SUSPECT W-WITNESS V-VICTIM O-OTHER)				42. ADDRESS		43. TELEPHONE	
CODE	40. NAME-LAST	FIRST	MI	41. D.O.B.			

On 02-28-99 I, Deputy Jost, received this complaint reference the H and R. Due to the lack of information on the plate and the style of vehicle involved I do not believe this vehicle is a match. Description was a Chev S-10 with a dark blue colored cap. Further description was that it had a broken grill and a partial plate of 88-738, no other description available. No further follow-up needed. Information was added to S99-00242. *[Signature]* MJ

45. IF COMPLAINANT DIFFERENT THEN CALLER, ENTER NAME, ADDRESS, D.O.B., TELEPHONE.

46. IF CODE O (OTHER) IS USED IN FIELD #39, EXPLAIN.

INCIDENT REPORT: NOTE: IF SECTION 22 ABOVE HAS NUMBER 4 CHECKED, DO NOT GO BEYOND THIS LINE WITHOUT RECORDS SECTION BEING ADVISED, OR NO RECORD ENTRIES WILL BE MADE BELOW THIS LINE.

PROPERTY VALUE	26. PROPERTY	A. CURRENCY	B. JEWELRY	C. FURS CLOTHING	D. VEHICLE (LOCAL)	E. OFFICE EQUIPMENT	F. RADIO, TV CAMERAS	G. FIREARMS	H. HOUSE-HOLD GOODS
	STOLEN	\$	\$	\$	\$	\$	\$	\$	\$
	RECOVERED	\$	\$	\$	\$	\$	\$	\$	\$
	26. PROPERTY	I. CONSUMABLES	J. LIVESTOCK	K. DRUGS	L. MARINE ITEMS	M. CONSTRUCTION ITEMS	N. LAWN AND GARDEN	O. SPORTING GOODS	P. MISC BICYCLE
STOLEN	\$	\$	\$	\$	\$	\$	\$	\$	
RECOVERED	\$	\$	\$	\$	\$	\$	\$	\$	

27. PROPERTY RECOVERED: LOCALLY _____ OTHER JURISDICTION _____ (INSERT O OR L)

PROPERTY ITEMIZATION	PROPERTY STOLEN/RECOVERED ITEMIZATION, USE THE FOLLOWING FORMAT				
	28. QUANTITY	29. ARTICLE NAME	30. BRAND NAME	31. SERIAL NUMBER	32. CODE
					S <input type="checkbox"/> R <input type="checkbox"/>
					S <input type="checkbox"/> R <input type="checkbox"/>
					S <input type="checkbox"/> R <input type="checkbox"/>
					S <input type="checkbox"/> R <input type="checkbox"/>

33. PROPERTY DAMAGE AMOUNT \$ _____

34. INSURANCE COMPANY _____

35. OFFICER ASSAULTED Y N 36. ARSON Y N 37. STRUCTURE CODE _____ 38. DAMAGE \$ _____

47. CIB ENTERED CANCELLED
 NCIC
 OTHER BROADCAST

48. TOTAL AMOUNT PROPERTY STOLEN \$ _____

49. TOTAL AMOUNT PROPERTY RECOVERED \$ _____

50. IS REPORT CONTINUED? YES NO

51. CAUTION INDICATORS, ATLS ETC.

52. DATA PROCESS INFORMATION:

COMPUTER ENTERED DATE 3.8.99
 MICROFILM INDEXED INITIAL AS

53. FILE APPROVAL

IS CASE CLASSIFICATION CORRECT? Y N
 IF N HAS CORRECTION BEEN MADE? Y N

BY [Signature] DATE 3.8.99

1. CASE # S99 No 01631 2. CLASSIFICATION 6.310.11 3. CENSUS 6010.00

INCIDENT CS / S99-00242

INCIDENT LOCATION Mtwc Co.

6. NAME - LAST - FIRST MI [REDACTED] 7. D.O.B. [REDACTED]

8. ADDRESS [REDACTED] 9. TX-HOME [REDACTED]

11. CITY STATE ZIP Mtwc [REDACTED] 10. TX-BUSINESS [REDACTED]

12. DETAILS Crimestoppers Tip.

0935
2-25-99

14. REC'D	15. DISP	16. 10-23	17. 10-24
13. DAY			
SUN 1	MON 2	TUE 3	WED 4
	THU 5	FRI 6	SAT 7

MANITOWOC COUNTY SHERIFF
INCIDENT CARD

18. ASSIGNED [REDACTED] 929
[REDACTED] Bushman 411
[REDACTED] 430

19. REC. BY 941 20. DIS. BY [REDACTED]

22. TYPE OF REPORT
 1. INCIDENT
 2. ACCIDENT
 3. CITATION
 4. NONE

21. HOW REC'D.
 1. 911
 2. POLICE RADIO
 3. PHONE
 4. TTY
 5. IN PERSON
 6. ON VIEW
 7. OFF. OFF DUTY
 8. C.B. RADIO
 9. OTHER

23. STATUS
 1. UNFOUNDED
 2. PNL
 3. OTHER
 4. CLEARED
 5. EXCEPT CLEARED

24. DATE CLEARED 03/08/99

25. OFFENSE TYPE
 1. ADULT NA
 2. JUVENILE
 3. UNKNOWN

39. (CODE S-SUSPECT W-WITNESS V-VICTIM O-OTHER)				40. NAME-LAST	FIRST	MI	41. D.O.B.	42. ADDRESS	43. TELEPHONE
O	Doan, Donald L.	111598	[REDACTED]	[REDACTED]	[REDACTED]	[REDACTED]	[REDACTED]	Old Hwy 151	

02/25/99 @ 1040 hrs. This Lt. received this crime stopper and contacted [REDACTED] by phone at [REDACTED]. She advised me that she was watching TV w/ [REDACTED] last night and saw the TV section pertaining to the H & R fatal. She stated that they began talking and that alot of indications lead them to suspect Donald L. Doan, who resides at [REDACTED] Hwy 151, Mtwc. She was questioned further and she indicated that this individual has alot of vehicles in his driveway and yard. He is also a heavy drinker and does use the roadway where the 10-50 happened. He attends the bars in that area. She states that over one year ago [REDACTED] did sell a chevy grill to this individual and that prior to the first of the year the grill was outside in this person's yard. Now [REDACTED] states that he has not seen the grill recently. Other than she thinks this person could do a thing like this, no other further information was obtained from her. She was advised to keep in contact if she receives any further info. This information will be passed onto Lt. Bushman for further follow-up. A check of the H & R data base does not indicate this suspects has been checked. TKO

02/25/99 Attempted contact a [REDACTED] Old Hwy 151, no one home. One cadillac, Full Ford sedan and an old tan Chev van which hasn't been run for a while parked in the yard. TKO

02/26/99 Attempted contact and met with Doan's wife. Donald was not home he is working driving a Chev van cleaning carpets with his business. Should be home late.

Contact made with the nextdoor neighbor at Seibolt Implement Co. He sees Donald Doan's van every day and has not observed any damage now or the past year. There is an old van parked in the yard which has never been driven, its used for parts. No other vehicles owned by Doan matching the description.

1930hrs Donald Doan did come to MTSO with his van and it was viewed. It is a 76 Chev no match, no damage, very cooperative. Close Complaint. J. Bushman

S99 No 01631

45. IF COMPLAINANT DIFFERENT THEN CALLER, ENTER NAME, ADDRESS, D.O.B., TELEPHONE.

46. IF CODE O (OTHER) IS USED IN FIELD #39, EXPLAIN.

INCIDENT REPORT: NOTE: IF SECTION 22 ABOVE HAS NUMBER 4 CHECKED, DO NOT GO BEYOND THIS LINE WITHOUT RECORDS SECTION BEING ADVISED, OR NO RECORD ENTRIES WILL BE MADE BELOW THIS LINE.

PROPERTY VALUE	26. PROPERTY	A. CURRENCY	B. JEWELRY	C. FURS CLOTHING	D. VEHICLE (LOCAL)	E. OFFICE EQUIPMENT	F. RADIO, TV CAMERAS	G. FIREARMS	H. HOUSE-HOLD GOODS
	STOLEN	\$	\$	\$	\$	\$	\$	\$	\$
	RECOVERED	\$	\$	\$	\$	\$	\$	\$	\$
	26. PROPERTY	I. CONSUMABLES	J. LIVESTOCK	K. DRUGS	L. MARINE ITEMS	M. CONSTRUCTION ITEMS	N. LAWN AND GARDEN	O. SPORTING GOODS	P. MISC BICYCLE
STOLEN	\$	\$	\$	\$	\$	\$	\$	\$	
RECOVERED	\$	\$	\$	\$	\$	\$	\$	\$	

27. PROPERTY RECOVERED: LOCALLY _____ OTHER JURISDICTION _____ (INSERT O OR L)

PROPERTY ITEMIZATION	PROPERTY STOLEN/RECOVERED ITEMIZATION, USE THE FOLLOWING FORMAT				
	28. QUANTITY	29. ARTICLE NAME	30. BRAND NAME	31. SERIAL NUMBER	32. CODE
					S <input type="checkbox"/> R <input type="checkbox"/>
					S <input type="checkbox"/> R <input type="checkbox"/>
					S <input type="checkbox"/> R <input type="checkbox"/>
					S <input type="checkbox"/> R <input type="checkbox"/>

33. PROPERTY DAMAGE AMOUNT \$ _____ 34. INSURANCE COMPANY _____

35. OFFICER ASSAULTED Y N 36. ARSON Y N 37. STRUCTURE CODE _____ 38. DAMAGE \$ _____

47. CIB <input type="checkbox"/> ENTERED <input type="checkbox"/> CANCELLED <input type="checkbox"/> NCIC <input type="checkbox"/> OTHER BROADCAST <input type="checkbox"/>	48. TOTAL AMOUNT PROPERTY STOLEN \$ _____
	49. TOTAL AMOUNT PROPERTY RECOVERED \$ _____

50. IS REPORT CONTINUED? YES NO 51. CAUTION INDICATORS, ATLS ETC. _____

52. DATA PROCESS INFORMATION:

COMPUTER ENTERED DATE _____

MICROFILM INDEXED INITIAL _____ FILE APPROVAL _____

IS CASE CLASSIFICATION CORRECT? IF N HAS CORRECTION BEEN MADE? _____ DATE **030899**

1. CASE # **S99 N^o 01633** | 2. CLASSIFICATION **630,1** | 3. CENSUS **7,010,00**

4. INCIDENT **CS/S99-00242**

5. INCIDENT LOCATION

NAME - FIRST - MI | 7. D.O.B.

ADDRESS | 9. TX-HOME

11. CITY | STATE | ZIP | 10. TX-BUSINESS

12. DETAILS
 Caller was told this past weekend while in tavern in Eagle River that an employee of Chizek's has a vehicle matching the descr of our suspect vehicle. This person lives in Sheboygan, and now does not drive that vehicle.

022599 1018

14. REC'D.	15. DISP.	16. 10-23	17. 10-24
13. DAY			
SUN 1	THU 5		
MON 2	FRI 6		
TUE 3	SAT 7		
WED 4			

MANITOWOC COUNTY SHERIFF INCIDENT CARD

18. ASSIGNED
Bushman | **9291**
HHV

19. REC. BY **920** | 20. DIS. BY
 22. TYPE OF REPORT
 1. INCIDENT
 2. ACCIDENT
 3. CITATION
 4. NONE

21. HOW REC'D.
 1. 911
 2. POLICE RADIO
 3. PHONE
 4. TTY
 5. IN PERSON
 6. ON VIEW
 7. OFF. OFF DUTY
 8. C.B. RADIO
 9. OTHER
 23. STATUS
 1. UNFOUNDED
 2. PNL
 3. OTHER
 4. CLEARED
 5. EXCEPT CLEARED

24. DATE CLEARED **031899**
 25. OFFENSE TYPE
 1. ADULT NA
 2. JUVENILE
 3. UNKNOWN

39. (CODE S-SUSPECT W-WITNESS V-VICTIM O-OTHER)						
CODE	40. NAME-LAST	FIRST	MI	41. D.O.B.	42. ADDRESS	43. TELEPHONE

02/25/99 1236hrs We have taken several similar complaints of suspect vehicles at the Chizek Trucking Company. Chizek has been very gracious in assisting. None of the prior complaints showed positive results and without more specific details as to whom we should look at we will not approach at this time. M.J.Bushman

CASE # S99 N^o 01633

45. IF COMPLAINANT DIFFERENT THEN CALLER, ENTER NAME, ADDRESS, D.O.B., TELEPHONE.

46. IF CODE O (OTHER) IS USED IN FIELD #39, EXPLAIN.

INCIDENT REPORT: NOTE: IF SECTION 22 ABOVE HAS NUMBER 4 CHECKED, DO NOT GO BEYOND THIS LINE WITHOUT RECORDS SECTION BEING ADVISED, OR NO RECORD ENTRIES WILL BE MADE BELOW THIS LINE.

PROPERTY VALUE	26. PROPERTY	A. CURRENCY	B. JEWELRY	C. FURS CLOTHING	D. VEHICLE (LOCAL)	E. OFFICE EQUIPMENT	F. RADIO, TV CAMERAS	G. FIREARMS	H. HOUSE-HOLD GOODS
	STOLEN	\$	\$	\$	\$	\$	\$	\$	\$
	RECOVERED	\$	\$	\$	\$	\$	\$	\$	\$
	26. PROPERTY	I. CONSUMABLES	J. LIVESTOCK	K. DRUGS	L. MARINE ITEMS	M. CONSTRUCTION ITEMS	N. LAWN AND GARDEN	O. SPORTING GOODS	P. MISC BICYCLE
STOLEN	\$	\$	\$	\$	\$	\$	\$	\$	
RECOVERED	\$	\$	\$	\$	\$	\$	\$	\$	

27. PROPERTY RECOVERED: LOCALLY _____ OTHER JURISDICTION _____ (INSERT O OR L)

PROPERTY ITEMIZATION	PROPERTY STOLEN/RECOVERED ITEMIZATION, USE THE FOLLOWING FORMAT				
	28. QUANTITY	29. ARTICLE NAME	30. BRAND NAME	31. SERIAL NUMBER	
					S <input type="checkbox"/> R <input type="checkbox"/>
					S <input type="checkbox"/> R <input type="checkbox"/>
					S <input type="checkbox"/> R <input type="checkbox"/>
					S <input type="checkbox"/> R <input type="checkbox"/>
					S <input type="checkbox"/> R <input type="checkbox"/>

33. PROPERTY DAMAGE AMOUNT \$ _____ 34. INSURANCE COMPANY _____

35. OFFICER ASSAULTED Y N 36. ARSON Y N 37. STRUCTURE CODE _____ 38. DAMAGE \$ _____

47. CIB <input type="checkbox"/>	ENTERED <input type="checkbox"/>	CANCELLED <input type="checkbox"/>	48. TOTAL AMOUNT PROPERTY STOLEN \$ _____
NCIC <input type="checkbox"/>	<input type="checkbox"/>	<input type="checkbox"/>	
OTHER BROADCAST <input type="checkbox"/>	<input type="checkbox"/>	<input type="checkbox"/>	
			49. TOTAL AMOUNT PROPERTY RECOVERED \$ _____

50. IS REPORT CONTINUED? YES NO 51. CAUTION INDICATORS, ATLS ETC.

52. DATA PROCESS INFORMATION

COMPUTER ENTERED DATE _____ APPROVAL _____

MICROFILM INDEXED INITIAL _____

IS CASE CLASSIFICATION CORRECT? IF N HAS CORRECTION BEEN MADE? _____ DATE 03 02 99

1. CASE # S99 No 01638
 2. CLASSIFICATION 6,3|0,1|
 3. CENSUS 1,4|0,1|1

4. INCIDENT CS/S99-00242

5. INCIDENT LOCATION

6. NAME - LAST - FIRST - MI Anon
 7. D.O.B.

8. ADDRESS
 9. TX-HOME

11. CITY STATE ZIP
 10. TX-BUSINESS

12. DETAILS
 Caller states there is an older couple that use to live at [redacted] S 19th and they winter

in Crossville TN. They were home for the holidays and a funeral, they own a GMC Suburban and may have been heading back to TN the night

01:10
 2-25-99
 REC'D
 DISP
 10-23
 10-24
 13. DAY
 SUN 1 THU 5
 MON 2 FRI 6
 TUE 3 SAT 7
 WED 4

MANITOWOC COUNTY SHERIFF INCIDENT CARD

18. ASSIGNED
 Bushman 9219
 HHV

19. REC. BY 926
 20. DIS. BY
 22. TYPE OF REPORT
 1. INCIDENT
 2. ACCIDENT
 3. CITATION
 4. NONE

21. HOW REC'D.
 1. 911
 2. POLICE RADIO
 3. PHONE
 4. TTY
 5. IN PERSON
 6. ON VIEW
 7. OFF. OFF DUTY
 8. C.B. RADIO
 9. OTHER
 21A. M.O.
 23. STATUS
 1. UNFOUNDED
 2. PNL
 3. OTHER
 4. CLEARED
 5. EXCEPT CLEARED
 24. DATE CLEARED 03/18/99
 25. OFFENSE TYPE
 1. ADULT
 2. JUVENILE
 3. UNKNOWN
 NA

39. (CODE S-SUSPECT W-WITNESS V-VICTIM O-OTHER)						
CODE	40. NAME-LAST	FIRST	MI	41. D.O.B.	42. ADDRESS	43. TELEPHONE
O	KRUMREY	WALTER		12005A	[redacted] SO. 19TH MIWOC	[redacted]
	KRUMREY	RECHARD		57603	[redacted] SO. 19TH MIWOC	[redacted]

in question. They have a son who lived at [redacted] S 19th, he just sold the house and was very stressed on the last visit about 3 - 4 weeks ago. The son Rick Krumrey is now also moving to Crossville TN. Parents are Walter & Eilene Krumrey. as/926
 02/25/99 1545hrs Contact by phone made with the complainant. He stated he thinks this is a long shot but this elderly couple left for Tennessee about the time of the accident and they own a General Motors Suburban. He has no idea of age of the vehicle. When asked if they were the type people to do such a thing he stated "Not Really, but they left about that time of accident and may have taken that route."

Contact made with Rick Krumrey. His parent's left for Crossville Tn. Sept. 29/98. Came home for a funeral and Christmas Dec. 16 by Grayhound Bus. They returned to Tn. 01/06/99 by Bus. Suburban remained behind in Tn. It is a 95 Chev Sub. recently traded for a 99 Chev. A RHAS message to DOT shows the 99 Chev. Reg. FJJ447. Close no further followup. M.J. Bushman

S99 No 01638

45. IF COMPLAINANT DIFFERENT THEN CALLER, ENTER NAME, ADDRESS, D.O.B., TELEPHONE.

46. IF CODE O (OTHER) IS USED IN FIELD #39, EXPLAIN.

INCIDENT REPORT: NOTE: IF SECTION 22 ABOVE HAS NUMBER 4 CHECKED, DO NOT GO BEYOND THIS LINE WITHOUT RECORDS SECTION BEING ADVISED, OR NO RECORD ENTRIES WILL BE MADE BELOW THIS LINE.

PROPERTY VALUE	26. PROPERTY	A. CURRENCY	B. JEWELRY	C. FURS CLOTHING	D. VEHICLE (LOCAL)	E. OFFICE EQUIPMENT	F. RADIO, TV CAMERAS	G. FIREARMS	H. HOUSE-HOLD GOODS
	STOLEN	\$	\$	\$	\$	\$	\$	\$	\$
	RECOVERED	\$	\$	\$	\$	\$	\$	\$	\$
	26. PROPERTY	I. CONSUMABLES	J. LIVESTOCK	K. DRUGS	L. MARINE ITEMS	M. CONSTRUCTION ITEMS	N. LAWN AND GARDEN	O. SPORTING GOODS	P. MISC BICYCLE
	STOLEN	\$	\$	\$	\$	\$	\$	\$	\$
	RECOVERED	\$	\$	\$	\$	\$	\$	\$	\$

27. PROPERTY RECOVERED: LOCALLY _____ OTHER JURISDICTION _____ (INSERT O OR L)

PROPERTY ITEMIZATION	PROPERTY STOLEN/RECOVERED ITEMIZATION, USE THE FOLLOWING FORMAT				
	28. QUANTITY	29. ARTICLE NAME	30. BRAND NAME	31. SERIAL NUMBER	32. CODE
					S R <input type="checkbox"/> <input type="checkbox"/>
					S R <input type="checkbox"/> <input type="checkbox"/>
					S R <input type="checkbox"/> <input type="checkbox"/>
					S R <input type="checkbox"/> <input type="checkbox"/>
					S R <input type="checkbox"/> <input type="checkbox"/>

33. PROPERTY DAMAGE AMOUNT \$ _____ 34. INSURANCE COMPANY _____

35. OFFICER ASSAULTED Y N 36. ARSON Y N 37. STRUCTURE CODE _____ 38. DAMAGE \$ _____

47. CIB ENTERED CANCELLED
 NCIC
 OTHER BROADCAST

48. TOTAL AMOUNT PROPERTY STOLEN \$ _____

49. TOTAL AMOUNT PROPERTY RECOVERED \$ _____

50. IS REPORT CONTINUED? YES NO

51. CAUTION INDICATORS, ATLS ETC.

52. DATA PROCESS INFORMATION:

COMPUTER ENTERED DATE 03 18 99
 MICROFILM INDEXED INITIAL [Signature]
 IS CASE CLASSIFICATION CORRECT? Y N
 IF N HAS CORRECTION BEEN MADE? Y N

53. FILE APPROVAL
 BY [Signature] DATE 03 18 99

1. CASE # S99 No 01640 2. CLASSIFICATION 6301 3. CENSUS 52000

4. INCIDENT No S99-00242 LOCATION

6. NAME - LAST - FIRST - MI Anonymous (2) 7. D.O.B.

8. ADDRESS 9. TX-HOME

11. CITY STATE ZIP 10. TX-BUSINESS

12. DETAILS See Attached.

02/25/99 1359

MANITOWOC COUNTY SHERIFF INCIDENT CARD

18. ASSIGNED M.K.O. 929
Bushman H.H.H.

19. REC. BY 435 20. DIS. BY
22. TYPE OF REPORT

21. HOW REC'D.
1. 911
2. POLICE RADIO
3. PHONE
4. TTY
5. IN PERSON
6. ON VIEW
7. OFF. OFF DUTY
8. C.B. RADIO
9. OTHER
23. STATUS
1. UNFOUNDED
2. PNL
3. OTHER
4. CLEARED
5. EXCEPT CLEARED
24. DATE CLEARED 03/08/99
25. OFFENSE TYPE
1. ADULT NA
2. JUVENILE
3. UNKNOWN

14. REC'D 15. DISP 16. 10-23 17. 10-24
13. DAY
SUN 1 THU 5
MON 2 FRI 6
TUE 3 SAT 7
WED 4

39. (CODE S-SUSPECT W-WITNESS V-VICTIM O-OTHER)						
CODE	40. NAME-LAST	FIRST	MI	41. D.O.B.	42. ADDRESS	43. TELEPHONE
0	Bohn Phillip C.			176282	Cleveland St., Neenah	

02/26/99 1906hrs Contact made with Winnebago Co. SO dispatcher Tammy by phone. The information passed on and request made to have officer stop by to obtain explanation of damage. Any questions contact MISO LT. Bushman working until midnight. M.J. Bushman

03/02/99 Upon returning to work a Teletype was read from Winnebago Co. reference checking this Crime-Stoppers report. Vehicle was located the following day. It is a Red/Tan GMC with lots of rust on the tan section. Vehicle has white rims, registration CA 57216, lists to above and Winnebago In-house shows an accident (hit a tree) in August of 1998. Close Out, M.J. Bushman

CASE # S99 No 01640

45. IF COMPLAINANT DIFFERENT THEN CALLER, ENTER NAME, ADDRESS, D.O.B., TELEPHONE.

46. IF CODE O (OTHER) IS USED IN FIELD #39, EXPLAIN.

INCIDENT REPORT: NOTE: IF SECTION 22 ABOVE HAS NUMBER 4 CHECKED, DO NOT GO BEYOND THIS LINE WITHOUT RECORDS SECTION BEING ADVISED, OR NO RECORD ENTRIES WILL BE MADE BELOW THIS LINE.

PROPERTY VALUE	26. PROPERTY	A. CURRENCY	B. JEWELRY	C. FURS CLOTHING	D. VEHICLE (LOCAL)	E. OFFICE EQUIPMENT	F. RADIO, TV CAMERAS	G. FIREARMS	H. HOUSE-HOLD GOODS
	STOLEN	\$	\$	\$	\$	\$	\$	\$	\$
	RECOVERED	\$	\$	\$	\$	\$	\$	\$	\$
	26. PROPERTY	I. CONSUMABLES	J. LIVESTOCK	K. DRUGS	L. MARINE ITEMS	M. CONSTRUCTION ITEMS	N. LAWN AND GARDEN	O. SPORTING GOODS	P. MISC BICYCLE
	STOLEN	\$	\$	\$	\$	\$	\$	\$	\$
	RECOVERED	\$	\$	\$	\$	\$	\$	\$	\$

27. PROPERTY RECOVERED: LOCALLY _____ OTHER JURISDICTION _____ (INSERT O OR L)

PROPERTY ITEMIZATION	PROPERTY STOLEN/RECOVERED ITEMIZATION, USE THE FOLLOWING FORMAT				
	28. QUANTITY	29. ARTICLE NAME	30. BRAND NAME	31. SERIAL NUMBER	32. CODE
					S <input type="checkbox"/> R <input type="checkbox"/>
					S <input type="checkbox"/> R <input type="checkbox"/>
					S <input type="checkbox"/> R <input type="checkbox"/>
					S <input type="checkbox"/> R <input type="checkbox"/>
					S <input type="checkbox"/> R <input type="checkbox"/>

33. PROPERTY DAMAGE AMOUNT \$ _____ 34. INSURANCE COMPANY _____

35. OFFICER ASSAULTED Y N 36. ARSON Y N 37. STRUCTURE CODE _____ 38. DAMAGE \$ _____

47. CIB ENTERED CANCELLED
 NCIC
 OTHER BROADCAST

48. TOTAL AMOUNT PROPERTY STOLEN \$ _____

49. TOTAL AMOUNT PROPERTY RECOVERED \$ _____

50. IS REPORT CONTINUED? YES NO

51. CAUTION INDICATORS, ATLS ETC.

52. DATA PROCESS INFORMATION:

COMPUTER ENTERED DATE 13.8.99
 MICROFILM INDEXED INITIAL KS

53. FILE APPROVAL

IS CASE CLASSIFICATION CORRECT? Y N
 IF N HAS CORRECTION BEEN MADE? Y N

BY  DATE 03.08.99

1. CASE # S99 No 01255 2 CLASSIFICATION 030.11 3 CENSUS 521000

4. INCIDENT CRIMESTOPPE / S99-00242

5. INCIDENT LOCATION Rapids Gas Station

6. NAME - LAST - FIRST - MI MTSO Jail 7 D.O.B.

ADDRESS 9. TX-HOME 10. TX-BUSINESS

11. CITY STATE ZIP

12. DETAILS
 Received call from G. Senn stating that a male came into the jail stating that he had just seen vehicle, light blue with front end damage, veh, is a truck/RP BE317T. S.U.B.I. at front counter Doug Vogel

0959 021399 6570

14. REC'D	15. DISP	16. 10-23	17. 10-24
13 DAY			
SUN 1	THU 5		
MON 2	FRI 6		
TUE 3	SAT 7		
WED 4			

MANITOWOC COUNTY SHERIFF INCIDENT CARD

18. ASSIGNED MTSO 9219

COLBORN 4312

19. REC. BY 20. DIS. BY 22. TYPE OF REPORT
 1. INCIDENT
 2. ACCIDENT
 3. CITATION
 4. NONE

21. HOW REC'D.
 1. 911
 2. POLICE RADIO
 3. PHONE
 4. TTY
 5. IN PERSON
 6. ON VIEW
 7. OFF. OFF DUTY
 8. C.B. RADIO
 9. OTHER

23. STATUS
 1. UNFOUNDED
 2. PNL
 3. OTHER
 4. CLEARED
 5. EXCEPT CLEARED

24. DATE CLEARED 02/16/99

25. OFFENSE TYPE
 1. ADULT NA
 2. JUVENILE
 3. UNKNOWN

39. (CODE S-SUSPECT W-WITNESS V-VICTIM O-OTHER)

CODE	40. NAME-LAST	FIRST	MI	41. D.O.B.	42. ADDRESS	43. TELEPHONE
0	PIESCHEL	TIMOTHY	L		N Woodland Dr. Two Rivers	

02/12/99: I, Deputy A. Colborn, was advised by C.O. G. Senn that DOUG VOGEL came to the front counter of MTSO Jail and requested an officer check a Chevy Blazer which he saw refueling at a gas station in Manitowoc Rapids. Apparently, this vehicle had some front end damage.

02/13/99: I located this vehicle at N Woodland Dr. The vehicle was found to be a Chevy Blazer S10 with minimal front end damage and no broken grill.

This vehicle is not the suspect vehicle from the fatal hit and run. This incident should be filed with incident S99-00242. ALColborn /bjc

45. IF COMPLAINANT DIFFERENT THEN CALLER, ENTER NAME, ADDRESS, D.O.B., TELEPHONE.

46. IF CODE O (OTHER) IS USED IN FIELD #39, EXPLAIN.

INCIDENT REPORT: NOTE: IF SECTION 22 ABOVE HAS NUMBER 4 CHECKED, DO NOT GO BEYOND THIS LINE WITHOUT RECORDS SECTION BEING ADVISED, OR NO RECORD ENTRIES WILL BE MADE BELOW THIS LINE.

PROPERTY VALUE	26. PROPERTY	A. CURRENCY	B. JEWELRY	C. FURS CLOTHING	D. VEHICLE (LOCAL)	E. OFFICE EQUIPMENT	F. RADIO, TV CAMERAS	G. FIREARMS	H. HOUSE-HOLD GOODS
	STOLEN	\$	\$	\$	\$	\$	\$	\$	\$
	RECOVERED	\$	\$	\$	\$	\$	\$	\$	\$
	26. PROPERTY	I. CONSUMABLES	J. LIVESTOCK	K. DRUGS	L. MARINE ITEMS	M. CONSTRUCTION ITEMS	N. LAWN AND GARDEN	O. SPORTING GOODS	P. MISC BICYCLE
STOLEN	\$	\$	\$	\$	\$	\$	\$	\$	
RECOVERED	\$	\$	\$	\$	\$	\$	\$	\$	

27. PROPERTY RECOVERED: LOCALLY _____ OTHER JURISDICTION _____ (INSERT O OR L)

PROPERTY ITEMIZATION	PROPERTY STOLEN/RECOVERED ITEMIZATION, USE THE FOLLOWING FORMAT				
	28. QUANTITY	29. ARTICLE NAME	30. BRAND NAME	31. SERIAL NUMBER	32. CODE
					S R <input type="checkbox"/> <input type="checkbox"/>
					S R <input type="checkbox"/> <input type="checkbox"/>
					S R <input type="checkbox"/> <input type="checkbox"/>
					S R <input type="checkbox"/> <input type="checkbox"/>

33. PROPERTY DAMAGE AMOUNT \$ _____

34. INSURANCE COMPANY _____

35. OFFICER ASSAULTED Y N 36. ARSON Y N 37. STRUCTURE CODE _____ 38. DAMAGE \$ _____

47. CIB ENTERED CANCELLED
 NCIC
 OTHER BROADCAST

48. TOTAL AMOUNT PROPERTY STOLEN \$ _____

49. TOTAL AMOUNT PROPERTY RECOVERED \$ _____

50. IS REPORT CONTINUED? YES NO

51. CAUTION INDICATORS, ATLS ETC.

52. DATA PROCESS INFORMATION:

COMPUTER ENTERED DATE 13/8/99
 MICROFILM INDEXED INITIAL KS

IS CASE CLASSIFICATION CORRECT? N
 IF N HAS CORRECTION BEEN MADE? Y

53. FILE APPROVAL

BY [Signature] DATE 02/16/99

1. CASE # S99 No 01303 | 2. CLASSIFICATION 6310.11 | 3. CENSUS 62000

4. COUNTY S99-00242 | 5. INCIDENT LOCATION

6. NAME- LAST, FIRST, MI [REDACTED] | 7. D.O.B. 128941

8. ADDRESS [REDACTED] | 9. TX-HOME [REDACTED] | 10. TX-BUSINESS [REDACTED]

11. CITY TWO RIVERS WI | STATE WI | ZIP 53241

12. DETAILS See Attached.

02/13/99 1530

MANITOWOC COUNTY SHERIFF INCIDENT CARD

18. ASSIGNED MTSO Colborn 929 432

19. REC. BY 435 | 20. DIS. BY 435 | 22. TYPE OF REPORT 1 INCIDENT
 21. HOW REC'D. 1. 911, 2. POLICE RADIO, 3. PHONE, 4. TTY, 5. IN PERSON, 6. ON VIEW, 7. OFF. OFF DUTY, 8. C.B. RADIO, 9. OTHER
 23. STATUS 1 UNFOUNDED, 2 PNL, 3 OTHER, 4 CLEARED, 5 EXCEPT CLEARED
 24. DATE CLEARED 02/16/99
 25. OFFENSE TYPE 1. ADULT, 2. JUVENILE, 3. UNKNOWN

14. REC'D	15. DISP	16. 10-23	17. 10-24
13. DAY			
SUN 1	THU 5		
MON 2	FRI 6		
TUE 3	SAT 7		
WED 4			

39. (CODE S-SUSPECT W-WITNESS V-VICTIM O-OTHER)						
CODE	40. NAME-LAST	FIRST	MI	41. D.O.B.	42. ADDRESS	43. TELEPHONE
O	EICHMANN	126424	KIRK	L	[REDACTED] S 24th St, Manitowoc	

02/13/99: I, Deputy A. Colborn, was assigned this incident by MTSO Dispatch. Preliminary information from Dispatch was that a caller called in a vehicle bearing WI RP 630050 and informed the Dispatcher the front end of the vehicle seemed "hokey."

I responded to [REDACTED] S 24th St, Manitowoc, where I located this vehicle. I observed the vehicle to be a 1977 vintage Chevrolet full-sized pickup truck with no structural front damage. Both fenders were intact. The front bumper and windshield were also intact and in serviceable condition. The only part of this truck which was missing was the grill. I did not observe any damage in the grill area which would indicate the vehicle struck someone.

This vehicle was found not to be the suspect vehicle from the fatal hit and run. This incident can be filed with S99-00242. ALColborn /bjc

45. IF COMPLAINANT DIFFERENT THEN CALLER, ENTER NAME, ADDRESS, D.O.B., TELEPHONE.

46. IF CODE O (OTHER) IS USED IN FIELD #39, EXPLAIN.

INCIDENT REPORT: NOTE: IF SECTION 22 ABOVE HAS NUMBER 4 CHECKED, DO NOT GO BEYOND THIS LINE WITHOUT RECORDS SECTION BEING ADVISED, OR NO RECORD ENTRIES WILL BE MADE BELOW THIS LINE.

PROPERTY VALUE	26. PROPERTY	A. CURRENCY	B. JEWELRY	C. FURS CLOTHING	D. VEHICLE (LOCAL)	E. OFFICE EQUIPMENT	F. RADIO, TV CAMERAS	G. FIREARMS	H. HOUSE-HOLD GOODS
	STOLEN	\$	\$	\$	\$	\$	\$	\$	\$
	RECOVERED	\$	\$	\$	\$	\$	\$	\$	\$
	26. PROPERTY	I. CONSUMABLES	J. LIVESTOCK	K. DRUGS	L. MARINE ITEMS	M. CONSTRUCTION ITEMS	N. LAWN AND GARDEN	O. SPORTING GOODS	P. MISC BICYCLE
STOLEN	\$	\$	\$	\$	\$	\$	\$	\$	
RECOVERED	\$	\$	\$	\$	\$	\$	\$	\$	

27. PROPERTY RECOVERED: LOCALLY _____ OTHER JURISDICTION _____ (INSERT O OR L)

PROPERTY ITEMIZATION	PROPERTY STOLEN/RECOVERED ITEMIZATION, USE THE FOLLOWING FORMAT				
	28. QUANTITY	29. ARTICLE NAME	30. BRAND NAME	31. SERIAL NUMBER	
					S <input type="checkbox"/> R <input type="checkbox"/>
					S <input type="checkbox"/> R <input type="checkbox"/>
					S <input type="checkbox"/> R <input type="checkbox"/>
					S <input type="checkbox"/> R <input type="checkbox"/>
					S <input type="checkbox"/> R <input type="checkbox"/>

33. PROPERTY DAMAGE AMOUNT \$ _____

34. INSURANCE COMPANY _____

35. OFFICER ASSAULTED Y N

36. ARSON Y N

37. STRUCTURE CODE _____

38. DAMAGE \$ _____

47. CIB ENTERED CANCELLED
 NCIC
 OTHER BROADCAST

48. TOTAL AMOUNT PROPERTY STOLEN \$ _____

49. TOTAL AMOUNT PROPERTY RECOVERED \$ _____

50. IS REPORT CONTINUED? YES NO

51. CAUTION INDICATORS, ATLS ETC.

52. DATA PROCESS INFORMATION:

COMPUTER ENTERED DATE 3/8/99
 MICROFILM INDEXED INITIAL KS

53. FILE APPROVAL

IS CASE CLASSIFICATION CORRECT? N
 IF N HAS CORRECTION BEEN MADE? N

BY [Signature] DATE 02/6/99

1. INCIDENT No 01311		2. CLASSIFICATION 6310.11		3. CENSUS 5210.00	
4. INCIDENT CS/S99-00242					
5. INCIDENT LOCATION					
6. NAME - LAST - FIRST - MI [REDACTED] 35200				7. D.O.B. [REDACTED]	
8. ADDRESS [REDACTED]				9. TX-HOME [REDACTED]	
11. CITY [REDACTED] STATE [REDACTED] ZIP [REDACTED]			10. TX-BUSINESS [REDACTED]		
12. DETAILS See Attached					
14. REC'D		15. DISP		17. 10-24	
SUN 1		THU 5		MON 2	
TUE 3		FRI 6		WED 4	
13. DAY		SAT 7			
19. REC. BY 935		20. DIS. BY 935		22. TYPE OF REPORT	
21. HOW REC'D		23. STATUS		24. DATE CLEARED 02/11/99	
1. 911		1. UNFOUNDED		25. OFFENSE TYPE	
2. POLICE RADIO		2. PNL		1. ADULT <input type="checkbox"/> NA <input type="checkbox"/>	
3. PHONE		3. OTHER		2. JUVENILE <input type="checkbox"/>	
4. TTY		4. CLEARED		3. UNKNOWN <input type="checkbox"/>	
5. IN PERSON		5. EXCEPT CLEARED			
6. ON VIEW					
7. OFF. OFF DUTY					
8. C.B. RADIO					
9. OTHER					
21A. M.O.					

39. (CODE S-SUSPECT W-WITNESS V-VICTIM O-OTHER)						
CODE	40. NAME-LAST	FIRST	MI	41. D.O.B.	42. ADDRESS	43. TELEPHONE
O	WALLANDER	CHRIS	R	[REDACTED]	STH 42, Manitowoc	[REDACTED]

021399: Deputy Colborn received info. Vehicle has been checked numerous times and not the veh. 935/lms

02/13/99: I, Deputy A. Colborn, was given this incident by MTSO Dispatch. I personally checked this vehicle. This vehicle has also been checked by Lt. M. Bushman.

This vehicle was found not to be the suspect vehicle for the fatal hit and run. This incident should be filed with incident S99-00242. ALColborn /bjc

S99 No 01311

45. IF COMPLAINANT DIFFERENT THEN CALLER, ENTER NAME, ADDRESS, D.O.B., TELEPHONE.

46. IF CODE O (OTHER) IS USED IN FIELD #39, EXPLAIN.

INCIDENT REPORT: NOTE: IF SECTION 22 ABOVE HAS NUMBER 4 CHECKED, DO NOT GO BEYOND THIS LINE WITHOUT RECORDS SECTION BEING ADVISED, OR NO RECORD ENTRIES WILL BE MADE BELOW THIS LINE.

PROPERTY VALUE	26. PROPERTY	A. CURRENCY	B. JEWELRY	C. FURS CLOTHING	D. VEHICLE (LOCAL)	E. OFFICE EQUIPMENT	F. RADIO, TV CAMERAS	G. FIREARMS	H. HOUSE-HOLD GOODS
	STOLEN	\$	\$	\$	\$	\$	\$	\$	\$
	RECOVERED	\$	\$	\$	\$	\$	\$	\$	\$
	26. PROPERTY	I. CONSUM-ABLES	J. LIVESTOCK	K. DRUGS	L. MARINE ITEMS	M. CONSTRUCTION ITEMS	N. LAWN AND GARDEN	O. SPORTING GOODS	P. MISC BICYCLE
	STOLEN	\$	\$	\$	\$	\$	\$	\$	\$
	RECOVERED	\$	\$	\$	\$	\$	\$	\$	\$

27. PROPERTY RECOVERED: LOCALLY ____ OTHER JURISDICTION ____ (INSERT O OR L)

PROPERTY ITEMIZATION	PROPERTY STOLEN/RECOVERED ITEMIZATION, USE THE FOLLOWING FORMAT				
	28. QUANTITY	29. ARTICLE NAME	30. BRAND NAME	31. SERIAL NUMBER	32. CODE
					S R <input type="checkbox"/> <input type="checkbox"/>
					S R <input type="checkbox"/> <input type="checkbox"/>
					S R <input type="checkbox"/> <input type="checkbox"/>
					S R <input type="checkbox"/> <input type="checkbox"/>

33. PROPERTY DAMAGE AMOUNT \$ _____

34. INSURANCE COMPANY _____

35. OFFICER ASSAULTED Y N

36. ARSON Y N

37. STRUCTURE CODE _____ 38. DAMAGE \$ _____

47. CIB ENTERED CANCELLED
 NCIC
 OTHER BROADCAST

48. TOTAL AMOUNT PROPERTY STOLEN \$ _____

49. TOTAL AMOUNT PROPERTY RECOVERED \$ _____

50. IS REPORT CONTINUED? YES NO

51. CAUTION INDICATORS, ATLS ETC.

52. DATA PROCESS INFORMATION:

COMPUTER ENTERED DATE 3/8/99
 MICROFILM INDEXED INITIAL AS

53. FILE APPROVAL

IS CASE CLASSIFICATION CORRECT? N
 IF N HAS CORRECTION BEEN MADE? N

BY GR DATE 10/16/99

1. CASE # S99 No 01312		2. CLASSIFICATION 6310.11		3. CENSUS 52090		
INCIDENT CS/S99-00242						
5. INCIDENT LOCATION						
6. NAME - LAST - FIRST - MI Mennymoes (2)				7. D.O.B.		
8. ADDRESS			9 TX-HOME			
11. CITY		STATE		ZIP		
10. TX-BUSINESS			12. DETAILS See Attached.			
14. REC'D	15. DISP	16. 10-23	17. 10-24	13. DAY SUN 1 THU 5 MON 2 FRI 6 TUE 3 SAT 7 WED 4		
19. REC. BY 935						
20. DIS. BY						
21. HOW REC'D. 1. 911 2. POLICE RADIO 3. PHONE 4. TTY 5. IN PERSON 6. ON VIEW 7. OFF. OFF DUTY 8. C.B. RADIO 9. OTHER						
22. TYPE OF REPORT 1. INCIDENT 2. ACCIDENT 3. CITATION 4. NONE						
23. STATUS 1. UNFOUNDED 2. PNL 3. OTHER 4. CLEARED 5. EXCEPT CLEARED						
24. DATE CLEARED 02/14/99						
25. OFFENSE TYPE 1. ADULT <input type="checkbox"/> NA <input type="checkbox"/> 2. JUVENILE <input type="checkbox"/> 3. UNKNOWN <input type="checkbox"/>						
21A. M.O.						
39. (CODE S-SUSPECT W-WITNESS V-VICTIM O-OTHER)						
CODE	40. NAME - LAST	FIRST	MI	41. D.O.B.	42. ADDRESS	43. TELEPHONE
O	BAXTER	MICHAEL			USH 151, Fond du Lac 54935	
W	[REDACTED]					

02/13/99 @ 2104 Hrs.: I, Lt. M. Bushman, was given this Crime Stopper report from Dispatch, and contact was made with FDSO. The information on the Crime Stopper Interview Form was that there was a white van with grill damage on USH 151 toward Fond du Lac, between BILL'S TREE SERVICE and PIPE EXPRESS. This information was given to the FDSO Dispatcher who was also given the phone number for MTSO. I requested, when an officer makes contact at the van, if he needs more information, he should not hesitate in calling MTSO.

02/13/99 @ 2203 Hrs.: Contact was made from FDSO, Sgt. Rick Olig. Sgt. Olig was on the scene with the vehicle and described the damage. The RP was CC96584 on a 1986 GMC truck, coming back to MICHAEL BAXTER of [REDACTED] USH 151, Fond du Lac. Sgt. Olig advised BAXTER informed him, approximately a year ago, he struck a deer with the vehicle and had not made the repairs. Sgt. Olig stated approximately one-half of the grill was still intact with damage sustained to the passenger or right portion of the grill. The headlight was intact. The bumper had no damage. There was no sheet metal damage above the grill work. There was rust where the paint was chipped slightly just below the grill. BAXTER advised he had not done any repairs. None of the sheet metal or plastic beyond the grill appeared to have any damage, nor was it repaired in the recent past.

This would not be the suspect vehicle we are looking for.

02/13/99 @ 2225 Hrs.: Contact was made by phone with the Crime Stopper informant, [REDACTED]. He was advised the vehicle had been checked, and there was no need for him to call back on 02/14/99 with the suspect's house number. [REDACTED] was thanked for his assistance and advised to keep his eyes open as he does get around the countryside on paper routes. MJBushman /bjc

CASE # S99 No 0131

45. IF COMPLAINANT DIFFERENT THEN CALLER, ENTER NAME, ADDRESS, D.O.B., TELEPHONE.

46. IF CODE O (OTHER) IS USED IN FIELD #39, EXPLAIN.

INCIDENT REPORT: NOTE: IF SECTION 22 ABOVE HAS NUMBER 4 CHECKED, DO NOT GO BEYOND THIS LINE WITHOUT RECORDS SECTION BEING ADVISED, OR NO RECORD ENTRIES WILL BE MADE BELOW THIS LINE.

PROPERTY VALUE	26. PROPERTY	A. CURRENCY	B. JEWELRY	C. FURS CLOTHING	D. VEHICLE (LOCAL)	E. OFFICE EQUIPMENT	F. RADIO, TV CAMERAS	G. FIREARMS	H. HOUSE-HOLD GOODS
	STOLEN	\$	\$	\$	\$	\$	\$	\$	\$
	RECOVERED	\$	\$	\$	\$	\$	\$	\$	\$
	26. PROPERTY	I. CONSUM-ABLES	J. LIVESTOCK	K. DRUGS	L. MARINE ITEMS	M. CONSTRUCTION ITEMS	N. LAWN AND GARDEN	O. SPORTING GOODS	P. MISC BICYCLE
	STOLEN	\$	\$	\$	\$	\$	\$	\$	\$
	RECOVERED	\$	\$	\$	\$	\$	\$	\$	\$

27. PROPERTY RECOVERED: LOCALLY _____ OTHER JURISDICTION _____ (INSERT O OR L)

PROPERTY ITEMIZATION	PROPERTY STOLEN/RECOVERED ITEMIZATION, USE THE FOLLOWING FORMAT				
	28. QUANTITY	29. ARTICLE NAME	30. BRAND NAME	31. SERIAL NUMBER	32. CODE
					S R <input type="checkbox"/> <input type="checkbox"/>
					S R <input type="checkbox"/> <input type="checkbox"/>
					S R <input type="checkbox"/> <input type="checkbox"/>
					S R <input type="checkbox"/> <input type="checkbox"/>
					S R <input type="checkbox"/> <input type="checkbox"/>

33. PROPERTY DAMAGE AMOUNT \$ _____ 34. INSURANCE COMPANY _____

35. OFFICER ASSAULTED Y N 36. ARSON Y N 37. STRUCTURE CODE _____ 38. DAMAGE \$ _____

47. CIB	ENTERED <input type="checkbox"/>	CANCELLED <input type="checkbox"/>	48. TOTAL AMOUNT PROPERTY STOLEN \$ _____
NCIC	<input type="checkbox"/>	<input type="checkbox"/>	
OTHER BROADCAST	<input type="checkbox"/>	<input type="checkbox"/>	
49. TOTAL AMOUNT PROPERTY RECOVERED \$ _____			

50. IS REPORT CONTINUED? YES NO 51. CAUTION INDICATORS, ATLS ETC.

52. DATA PROCESS INFORMATION:

COMPUTER ENTERED DATE 3/8/99

MICROFILM INDEXED INITIAL AS

IS CASE CLASSIFICATION CORRECT? Y N

IF N HAS CORRECTION BEEN MADE? Y N

53. FILE APPROVAL

BY CK DATE 02/16/99

1. CASE # S99 No 01318 2. CLASSIFICATION 1030.11 3. CENSUS 030.12

4. INCIDENT # CS 599-00242

5. INCIDENT LOCATION [REDACTED]

6. NAME [REDACTED] 7. D.O.B. [REDACTED]

8. ADDRESS [REDACTED] 9. TX-HOME [REDACTED]

11. CITY STATE ZIP 10. TX-BUSINESS [REDACTED]

12. DETAILS
 Reg an officer come to his home. He will take him to a vehicle. He feels should be checked.

2-18-99 2346
 2334
 CCCC

MANITOWOC COUNTY SHERIFF INCIDENT CARD			
18. ASSIGNED		929	
Froelich		4/16	
Bushman		4/41	
19. REC. BY	20. DIS. BY	22. TYPE OF REPORT	
928		<input checked="" type="checkbox"/> 1. INCIDENT <input type="checkbox"/> 2. ACCIDENT <input type="checkbox"/> 3. CITATION <input type="checkbox"/> 4. NONE	
21. HOW REC'D.		23. STATUS	
<input type="checkbox"/> 1. 911 <input type="checkbox"/> 2. POLICE RADIO <input checked="" type="checkbox"/> 3. PHONE <input type="checkbox"/> 4. TTY <input type="checkbox"/> 5. IN PERSON <input type="checkbox"/> 6. ON VIEW <input type="checkbox"/> 7. OFF. OFF DUTY <input type="checkbox"/> 8. C.B. RADIO <input type="checkbox"/> 9. OTHER		<input type="checkbox"/> 1. UNFOUNDED <input type="checkbox"/> 2. PNL <input checked="" type="checkbox"/> 3. OTHER <input type="checkbox"/> 4. CLEARED <input type="checkbox"/> 5. EXCEPT CLEARED	
14. REC'D		24. DATE CLEARED	
15. DISP 16. 10-23 17. 10-24		10/21/99	
13. DAY			
SUN 1		THU 5	
MON 2		FRI 6	
TUE 3		SAT 7	
WED 4			
21A. M.O.		25. OFFENSE TYPE	
		<input type="checkbox"/> 1. ADULT <input type="checkbox"/> NA <input type="checkbox"/> <input type="checkbox"/> 2. JUVENILE <input type="checkbox"/> <input type="checkbox"/> 3. UNKNOWN <input type="checkbox"/>	

39. (CODE S-SUSPECT W-WITNESS V-VICTIM O-OTHER)						
CODE	40. NAME-LAST	FIRST	MI	41. D.O.B.	42. ADDRESS	43. TELEPHONE
0	VANBOXEL	THOMAS	W		Loretta Ln, Green Bay 54302	
0	***ADDRESS CHECKED***				Old CTH CC	

02/13/99 @ 2330 Hrs.: I, Lt. M. Bushman, made contact with the complainant who wishes to remain anonymous at [REDACTED]. The complainant rode with me to Old CTH CC, pointing out a full-sized van parked behind a barn at [REDACTED] Old CTH CC.

The complainant was dropped off at his residence, and contact was made at [REDACTED] Old CTH CC. The owner of the property stated that I could go head and look at the vehicle which was among several other old vehicles behind the barn and anywhere else I wished to look on his property. The owner of the vehicle parked it approximately 2 months ago, and it has not been moved.

There were no RPs on the van. I noted it was a Ford. The VIN of [REDACTED] comes back on a 1983 Ford truck registered to THOMAS VANBOXEL from Green Bay. There was no damage to the front of the vehicle. The customized grill which was currently on the vehicle was quite rusty as it has been there for quite some time.

This would not be the suspect vehicle. MJBushman /bjc

S99 No 01318

45. IF COMPLAINANT DIFFERENT THEN CALLER, ENTER NAME, ADDRESS, D.O.B., TELEPHONE.

46. IF CODE O (OTHER) IS USED IN FIELD #39, EXPLAIN.

INCIDENT REPORT: NOTE: IF SECTION 22 ABOVE HAS NUMBER 4 CHECKED, DO NOT GO BEYOND THIS LINE WITHOUT RECORDS SECTION BEING ADVISED, OR NO RECORD ENTRIES WILL BE MADE BELOW THIS LINE.

PROPERTY VALUE	26. PROPERTY	A. CURRENCY	B. JEWELRY	C. FURS CLOTHING	D. VEHICLE (LOCAL)	E. OFFICE EQUIPMENT	F. RADIO, TV CAMERAS	G. FIREARMS	H. HOUSE-HOLD GOODS
	STOLEN	\$	\$	\$	\$	\$	\$	\$	\$
	RECOVERED	\$	\$	\$	\$	\$	\$	\$	\$
	26. PROPERTY	I. CONSUM-ABLES	J. LIVESTOCK	K. DRUGS	L. MARINE ITEMS	M. CONSTRUCTION ITEMS	N. LAWN AND GARDEN	O. SPORTING GOODS	P. MISC BICYCLE
STOLEN	\$	\$	\$	\$	\$	\$	\$	\$	
RECOVERED	\$	\$	\$	\$	\$	\$	\$	\$	

27. PROPERTY RECOVERED: LOCALLY _____ OTHER JURISDICTION _____ (INSERT O OR L)

PROPERTY ITEMIZATION	PROPERTY STOLEN/RECOVERED ITEMIZATION, USE THE FOLLOWING FORMAT				
	28. QUANTITY	29. ARTICLE NAME	30. BRAND NAME	31. SERIAL NUMBER	32. CODE
					S <input type="checkbox"/> R <input type="checkbox"/>
					S <input type="checkbox"/> R <input type="checkbox"/>
					S <input type="checkbox"/> R <input type="checkbox"/>
					S <input type="checkbox"/> R <input type="checkbox"/>
					S <input type="checkbox"/> R <input type="checkbox"/>
					S <input type="checkbox"/> R <input type="checkbox"/>

33. PROPERTY DAMAGE AMOUNT \$ _____

34. INSURANCE COMPANY _____

35. OFFICER ASSAULTED Y N 36. ARSON Y N 37. STRUCTURE CODE _____ 38. DAMAGE \$ _____

47. CIB ENTERED CANCELLED
 NCIC
 OTHER BROADCAST

48. TOTAL AMOUNT PROPERTY STOLEN \$ _____

49. TOTAL AMOUNT PROPERTY RECOVERED \$ _____

50. IS REPORT CONTINUED? YES NO

51. CAUTION INDICATORS, ATLS ETC.

52. DATA PROCESS INFORMATION:

COMPUTER ENTERED DATE 3/8/99
 MICROFILM INDEXED INITIAL KS

IS CASE CLASSIFICATION CORRECT? N
 IF N HAS CORRECTION BEEN MADE? N

53. FILE APPROVAL

BY GK DATE 02/16/99

1. CASE # S99 No 01327 | 2. CLASSIFICATION 6,310,11 | 3. CENSUS 5,210,00

4. INCIDENT CS / S99-00242
 INCIDENT LOCATION Fleet Farm Pkg. lot.

5. NAME - LAST-FIRST-MI ANONY. (2) | 7. D.O.B.

8. ADDRESS | 9. TX-HOME

11. CITY STATE ZIP | 10. TX-BUSINESS

12. DETAILS See Attached.

1014
 02-14-99
 14. REC'D
 15. DISP
 16. 10-23
 17. 10-24
 13. DAY
 SUN 1 THU 5
 MON 2 FRI 6
 TUE 3 SAT 7
 WED 4

MANITOWOC COUNTY SHERIFF INCIDENT CARD

18. ASSIGNED
 Bushman HHV

19. REC. BY 938 | 20. DIS. BY
 22. TYPE OF REPORT
 1. INCIDENT
 2. ACCIDENT
 3. CITATION
 4. NONE

21. HOW REC'D.
 1. 911
 2. POLICE RADIO
 3. PHONE
 4. TTY
 5. IN PERSON
 6. ON VIEW
 7. OFF OFF DUTY
 8. C.B. RADIO
 9. OTHER
 23. STATUS
 1. UNFOUNDED
 2. PNL
 3. OTHER
 4. CLEARED
 5. EXCEPT CLEARED

24. DATE CLEARED 02/16/99
 25. OFFENSE TYPE
 1. ADULT NA
 2. JUVENILE
 3. UNKNOWN

39. (CODE S-SUSPECT W-WITNESS V-VICTIM O-OTHER)				41. D.O.B.	42. ADDRESS	43. TELEPHONE
CODE	40. NAME-LAST	FIRST	MI			
O	RODEWALD	TRAVIS	C		STH 310, Manitowoc	

02-14-99 Deputy Colborn checked address listed on 28, [redacted] Hwy 310, and party who owns truck will not be home until after 2200 hrs. Will pass onto Lt. Bushman. 938/KB

02/14/99 @ 2230 Hrs.: I, Lt. M. Bushman, followed up on this Crime Stopper report by viewing a 1989 Chevrolet pickup truck parked at [redacted] STH 310, Manitowoc. The vehicle is of the wrong design type of vehicle we are looking for and is not the suspect vehicle. There was minor damage to the front end; however, the vehicle does not match the model we are looking for. MJBushman /bjc

CASE # S99 No 01327

45. IF COMPLAINANT DIFFERENT THEN CALLER, ENTER NAME, ADDRESS, D.O.B., TELEPHONE.

46. IF CODE O (OTHER) IS USED IN FIELD #39, EXPLAIN.

INCIDENT REPORT: NOTE: IF SECTION 22 ABOVE HAS NUMBER 4 CHECKED, DO NOT GO BEYOND THIS LINE WITHOUT RECORDS SECTION BEING ADVISED, OR NO RECORD ENTRIES WILL BE MADE BELOW THIS LINE.

PROPERTY VALUE	26. PROPERTY	A. CURRENCY	B. JEWELRY	C. FURS CLOTHING	D. VEHICLE (LOCAL)	E. OFFICE EQUIPMENT	F. RADIO, TV CAMERAS	G. FIREARMS	H. HOUSE-HOLD GOODS
	STOLEN	\$	\$	\$	\$	\$	\$	\$	\$
	RECOVERED	\$	\$	\$	\$	\$	\$	\$	\$
	26. PROPERTY	I. CONSUMABLES	J. LIVESTOCK	K. DRUGS	L. MARINE ITEMS	M. CONSTRUCTION ITEMS	N. LAWN AND GARDEN	O. SPORTING GOODS	P. MISC BICYCLE
	STOLEN	\$	\$	\$	\$	\$	\$	\$	\$
	RECOVERED	\$	\$	\$	\$	\$	\$	\$	\$

27. PROPERTY RECOVERED: LOCALLY _____ OTHER JURISDICTION _____ (INSERT O OR L)

PROPERTY ITEMIZATION	PROPERTY STOLEN/RECOVERED ITEMIZATION, USE THE FOLLOWING FORMAT				
	28. QUANTITY	29. ARTICLE NAME	30. BRAND NAME	31. SERIAL NUMBER	32. CODE
					S R <input type="checkbox"/> <input type="checkbox"/>
					S R <input type="checkbox"/> <input type="checkbox"/>
					S R <input type="checkbox"/> <input type="checkbox"/>
					S R <input type="checkbox"/> <input type="checkbox"/>
					S R <input type="checkbox"/> <input type="checkbox"/>

33. PROPERTY DAMAGE AMOUNT \$ _____ 34. INSURANCE COMPANY _____

35. OFFICER ASSAULTED Y N 36. ARSON Y N 37. STRUCTURE CODE _____ 38. DAMAGE \$ _____

47. CIB ENTERED CANCELLED
 NCIC
 OTHER BROADCAST

48. TOTAL AMOUNT PROPERTY STOLEN \$ _____
 49. TOTAL AMOUNT PROPERTY RECOVERED \$ _____

50. IS REPORT CONTINUED? YES NO

51. CAUTION INDICATORS, ATLS ETC.

52. DATA PROCESS INFORMATION:
 COMPUTER ENTERED DATE 3.8.99
 MICROFILM INDEXED INITIAL AS
 IS CASE CLASSIFICATION CORRECT? Y N
 IF N HAS CORRECTION BEEN MADE? Y N

53. FILE APPROVAL
 BY AK DATE 10/21/99

1. CASE # S99 No 01338 2. CLASSIFICATION 63011 3. CENSUS 521000

4. INCIDENT CS/599-00242

5. INCIDENT LOCATION

6. NAME - LAST-FIRST-MI Anonymous (a) 7. D.O.B.

8. ADDRESS 9. TX-HOME

11. CITY STATE ZIP 10. TX-BUSINESS

12. DETAILS
Rpts overhearing info that
Shane Sjogren of Green Bay
may be a suspect. See
attached form

02-15-99 1044

MANITOWOC COUNTY SHERIFF
INCIDENT CARD

18. ASSIGNED 929
M. Bushman 444
Jost 444

19. REC. BY 901 20. DIS. BY

21. HOW REC'D.
1. 911
2. POLICE RADIO
3. PHONE CS
4. TTY
5. IN PERSON
6. ON VIEW
7. OFF. OFF DUTY
8. C.B. RADIO
9. OTHER

22. TYPE OF REPORT
1. INCIDENT
2. ACCIDENT
3. CITATION
4. NONE

23. STATUS
1. UNFOUNDED
2. PNL
3. OTHER
4. CLEARED
5. EXCEPT CLEARED

24. DATE CLEARED 15/1700

25. OFFENSE TYPE
1. ADULT NA
2. JUVENILE
3. UNKNOWN

13. DAY
SUN 1 THU 5
MON 2 FRI 6
TUE 3 SAT 7
WED 4

14. REC'D. 15. DISP. 16. 10-23 17. 10-24

21A. M.O.

39. (CODE S-SUSPECT W-WITNESS V-VICTIM O-OTHER)							
CODE	40. NAME- LAST	FIRST	MI	41. D.O.B.	42. ADDRESS	43. TELEPHONE	
0	Sjogren	Shane	M		Unknown		
0	Delagarza	Henry	NMI		Perrot St. Green Bay		
0	Posvic	Carl	H.		S. Broadway St. Green Bay		
0	Segersin Edward		L.		Sunbeam Cr. Oneida		
0	Bronkhorst	William	P.		1/2 Day St. Green Bay		

02-15-99 I, Deputy Jost, was assigned to this complaint. It appears the vehicle was sold to William Bronkhorst by Shane Sjogren. No contact has yet been made with William as I was informed by a co-worker Bill will be out of town until early next week. Additional information was added to S99-00242, please see that report for more detailed information. Jost JMJ

03/30/99 Off. Todd Lepine, make contact with Bronkhorst and see if Sjogren did in fact sell him his old Chev Blazer or Suburban and was it damaged, and where did it get fixed. What was the year and what was damaged. See if he or Sjogren has an explanation of the damage and anyone that can verify that explanation. Thank you very much, I work the next five nights 2000hrs to 0400hrs. M.J. Bushman

04/16/99 Attempted contact with Off. Lepine, on days off, back. Sunday 041899 1900hrs. MJB

45. IF COMPLAINANT DIFFERENT THEN CALLER, ENTER NAME, ADDRESS, D.O.B., TELEPHONE.

46. IF CODE O (OTHER) IS USED IN FIELD #39, EXPLAIN.

INCIDENT REPORT: NOTE: IF SECTION 22 ABOVE HAS NUMBER 4 CHECKED, DO NOT GO BEYOND THIS LINE WITHOUT RECORDS SECTION BEING ADVISED, OR NO RECORD ENTRIES WILL BE MADE BELOW THIS LINE.

PROPERTY VALUE	26. PROPERTY	A. CURRENCY	B. JEWELRY	C. FURS CLOTHING	D. VEHICLE (LOCAL)	E. OFFICE EQUIPMENT	F. RADIO, TV CAMERAS	G. FIREARMS	H. HOUSE-HOLD GOODS
	STOLEN	\$	\$	\$	\$	\$	\$	\$	\$
	RECOVERED	\$	\$	\$	\$	\$	\$	\$	\$
	26. PROPERTY	I. CONSUMABLES	J. LIVESTOCK	K. DRUGS	L. MARINE ITEMS	M. CONSTRUCTION ITEMS	N. LAWN AND GARDEN	O. SPORTING GOODS	P. MISC BICYCLE
STOLEN	\$	\$	\$	\$	\$	\$	\$	\$	
RECOVERED	\$	\$	\$	\$	\$	\$	\$	\$	

27. PROPERTY RECOVERED: LOCALLY _____ OTHER JURISDICTION _____ (INSERT O OR L)

PROPERTY ITEMIZATION	PROPERTY STOLEN/RECOVERED ITEMIZATION, USE THE FOLLOWING FORMAT				
	28. QUANTITY	29. ARTICLE NAME	30. BRAND NAME	31. SERIAL NUMBER	32. CODE
					S R <input type="checkbox"/> <input type="checkbox"/>
					S R <input type="checkbox"/> <input type="checkbox"/>
					S R <input type="checkbox"/> <input type="checkbox"/>
					S R <input type="checkbox"/> <input type="checkbox"/>
					S R <input type="checkbox"/> <input type="checkbox"/>

33. PROPERTY DAMAGE AMOUNT \$ _____ 34. INSURANCE COMPANY _____

35. OFFICER ASSAULTED Y N 36. ARSON Y N 37. STRUCTURE CODE _____ 38. DAMAGE \$ _____

47. CIB	ENTERED <input type="checkbox"/>	CANCELLED <input type="checkbox"/>	48. TOTAL AMOUNT PROPERTY STOLEN \$ _____
NCIC	<input type="checkbox"/>	<input type="checkbox"/>	
OTHER BROADCAST	<input type="checkbox"/>	<input type="checkbox"/>	
			49. TOTAL AMOUNT PROPERTY RECOVERED \$ _____

50. IS REPORT CONTINUED? YES NO 51. CAUTION INDICATORS, ATLS ETC.

52. DATA PROCESS INFORMATION:
 COMPUTER ENTERED DATE 15.17.09
 MICROFILM INDEXED INITIAL KS
 IS CASE CLASSIFICATION CORRECT? (Y) N
 IF N HAS CORRECTION BEEN MADE? N

53. FILE APPROVAL
 BY KS DATE 06/16/09

GREEN BAY POLICE DEPARTMENT

Detail Sheet

DISPATCH # _____

FILE # 99-08630 DATE 2-16-99
(if known)

COMPLAINANT/VICTIM _____ TIME AM 2:00 PM
(if known)

On the above date I received a call from Deputy Jost of the Manitowish Shippig Dept. requesting our assistance in their investigation of a hit & run fatality in their jurisdiction involving a Chev truck. Dep. Jost informed me they had received information on Crimestoppers that a Shane M. Sjogren of Green Bay had owned a similar truck and sold it three days after the fatality with front end damage. Dep. Jost said he had attempted contact with Sjogren via phone but no number could be located.

The address for Sjogren was given as [REDACTED] 5. Platten #107.

Our city directory indicated Sjogren resides in apt. #109.

I assigned Off. Paulyke to attempt to contact Sjogren and obtain the name of the person he sold the vehicle to per Dep. Jost's request. Off. Paulyke came up with the information attached.

A copy of this report was faxed to Dep. Jost at [REDACTED]

A report was generated due to the seriousness of this offense.

No further follow up needed at this time.

GREEN BAY POLICE DEPARTMENT
Detail Sheet

FILE # 99-08630 DATE 02-16-99
COMP/VICTIM _____ TIME _____

ON 02-16-99 AT ABOUT 5:45PM I WENT TO [REDACTED] S. PLATTEN ST.# 109 TO ASSIST MANITOWOC COUNTY SHERIFF'S DEPARTMENT IN MAKING CONTACT WITH A SUBJECT(SHANE M. SJOGREN [REDACTED]) AT THIS LOCATION. WHEN I ARRIVED ON SCENE I WAS MET AT THE DOOR BY A FEMALE WHO STATED THAT SHANE DOES LIVE HERE BUT THAT HE IS AT A FRIEND'S HOUSE AND IS GOING TO BE SPENDING THE NIGHT OVER THERE. I THEN ASKED HER IF SHE KNEW WHO SHANE SOLD HIS TRUCK TO AND SHE TOLD ME THAT HE SOLD IT TO BILL BRONKHORST. SHE SAID THAT BILL LIVES OVER ON THE EAST SIDE OF TOWN BUT DID NOT KNOW THE ADDRESS.

I THEN WENT TO THE STATION AND FOUND THIS SUBJECT IN OUR MASTER FILE. THE MOST RECENT ADDRESS ON BILL IS [REDACTED] 1/2 DAY ST. GREEN BAY, WI 54302. HIS HOME PHONE # IS [REDACTED] AND WORK # IS [REDACTED]. HIS NAME AND DOB IS WILLIAM P. BRONKHORST [REDACTED].

PHONE # for SJOGREN: [REDACTED]

*ON VACATION TIL EARLY NEXT WEEK
HAS A SEVERADO BEER BLAND NEW
NO BLAZ./SUB,*

*02-18-99
1540 HRS. HENRY NUNE DELAGARZA
[REDACTED]
[REDACTED] PERROT ST. GB,*

James L. Pautzke

JAMES L. PAUTZKE 282
Officer - GBPD

CBPD
D-1 (1998)

GREEN BAY POLICE DEPARTMENT
CASE REPORT

Page 1 of 2 Pages

<input checked="" type="checkbox"/> On Report <input type="checkbox"/> Telephone Report <input type="checkbox"/> Officer at Scene		<input type="checkbox"/> Other <input type="checkbox"/> Fax		Units Disp. 221A		
1. Type of Incident Assist other Jurisdiction		2. Weapon/tool used		3. Date/Time Reported: Month Day Year AM PM		
4. Location (street, apt.#, city, state) S. Platten St. #109 Green Bay, WI		5. Date / time occurred Month Day Year AM 5:45 PM 02-16-99				
R E P O R T E D B Y	6. <input checked="" type="checkbox"/> victim <input type="checkbox"/> complainant <input type="checkbox"/> other	(last, first, middle) Manitowoc County		Sex	Race	
	7. Residence address (street, apt.#, city)		State	Zip	Residence Phone	
	8. Business address (street, apt.#, city, state)		Statement Y N		Business Phone	
V I C T I M	9. Full Name (last, first, middle) or company		Sex	Race	DOB: Month Day Year	
	10. Residence address (street, apt.#, city)		State	Zip	Residence Phone	
	11. Business address (street, apt.#, city, state)		Statement Y N		Business Phone	
12. Was there a witness to the crime? If yes, place an "X" in the box to the left.						
W I T N E S S & V I C T I M	13. <input type="checkbox"/> victim <input type="checkbox"/> other <input type="checkbox"/> witness	(last, first, middle)		DOB:	Sex Race Relationship to Victim	
	14. Residence address (street, apt.#, city)		State	Zip	Residence Phone	
	15. Business address (street, apt.#, city, state)		Statement Y N		Business Phone	
	16. <input type="checkbox"/> victim <input type="checkbox"/> other <input type="checkbox"/> witness	(last, first, middle)		DOB:	Sex Race Relationship to Victim	
	17. Residence address (street, apt.#, city)		State	Zip	Residence Phone	
	18. Business address (street, apt.#, city, state)		Statement Y N		Business Phone	
19. NAME (last, first, middle) J# _____ ID# _____			20. NAME (last, first, middle) J# _____ ID# _____			
21. ADDRESS: (Street, apt.#, city)		Phone #	22. ADDRESS: (Street, apt.#, city)		Phone #	
23. DOB/Age	Sex	Race	Hgt	Wgt	Hair Color Eyes	
25. Clothing, facial hair, unusual features, speech, glasses			Statement Y N		26. Clothing, facial hair, unusual features, speech, glasses	
27. Charge		Statute No.	Ordinance Felony Misdemeanor		28. Charge	
Charge:		Statute No.	Ordinance Felony Misdemeanor		Statute No.	
Charge:		Statute No.	Ordinance Felony Misdemeanor		Statute No.	
Charge:		Statute No.	Ordinance Felony Misdemeanor		Statute No.	
29. Point of entry where attacked:					Enter NCIC	
30. Method of entry / attach:					"0" File <input checked="" type="checkbox"/>	
31. Briefly describe evidence			32. Photos taken? Y N	33. Locker #		
34. Is property traceable? If yes, place an "X" in the box at left.					Index/Return _____ Press Copy _____	
35. Person taking report Name J. Paulsen		Comp. # 282	36. Read & approved by: J. St. 145		37. Assigned by:	
38. No. of Solvability factors		39. Further inv. Y N	40. Assigned to:		41. Case # 99-08630	

1. CASE # **899 No 01353** 2. CLASSIFICATION **0301** 3. CENSUS **70000**

4. INCIDENT **CS-599-00242**

5. INCIDENT LOCATION **I 43 N of Shyb. Westside of I**

6. NAME- LAST-FIRST-MI **Anon.** 7. D.O.B.

8. ADDRESS 9. TX-HOME

11. CITY STATE ZIP 10. TX-BUSINESS

12. DETAILS
Caller saw what appears to be a white pick up truck partly submerged in a man made pond.

021599 1507

14. REC'D	15. DISP	16. 10-23	17. 10-24
SUN 1	THU 5		
MON 2	FRI 6		
TUE 3	SAT 7		
WED 4			

MANITOWOC COUNTY SHERIFF INCIDENT CARD

18. ASSIGNED **MISO, P.229 Lt Bushman 1/14/1**

19. REC. BY **944** 20. DIS. BY

22. TYPE OF REPORT
 INCIDENT
 ACCIDENT
 CITATION
 NONE

21. HOW REC'D.
 911
 POLICE RADIO
 PHONE
 TTY
 IN PERSON
 ON VIEW
 OFF. OFF DUTY
 C.B. RADIO
 OTHER

23. STATUS
 UNFOUNDED
 PNL
 OTHER
 CLEARED
 EXCEPT CLEARED

24. DATE CLEARED **02/16/99**

25. OFFENSE TYPE
 1. ADULT NA
 2. JUVENILE
 3. UNKNOWN

21A. M.O.

39. (CODE S-SUSPECT W-WITNESS V-VICTIM O-OTHER)				41. D.O.B.		42. ADDRESS		43. TELEPHONE	
CODE	40. NAME-LAST	FIRST	MI						

02/15/99 1510hrs I Lt. Bushman did speak with the Complainant and obtained a detailed description of the location. Information passed along to Dep. Jost working patrol. He checked the location and found an ice shanty partially submerged with a p/u truck cap for a roof. Close out complaint. M.J. Bushman

45. IF COMPLAINANT DIFFERENT THEN CALLER, ENTER NAME, ADDRESS, D.O.B., TELEPHONE.

46. IF CODE O (OTHER) IS USED IN FIELD #39, EXPLAIN.

INCIDENT REPORT: NOTE: IF SECTION 22 ABOVE HAS NUMBER 4 CHECKED, DO NOT GO BEYOND THIS LINE WITHOUT RECORDS SECTION BEING ADVISED, OR NO RECORD ENTRIES WILL BE MADE BELOW THIS LINE.

PROPERTY VALUE	26. PROPERTY	A. CURRENCY	B. JEWELRY	C. FURS CLOTHING	D. VEHICLE (LOCAL)	E. OFFICE EQUIPMENT	F. RADIO, TV CAMERAS	G. FIREARMS	H. HOUSE-HOLD GOODS
	STOLEN	\$	\$	\$	\$	\$	\$	\$	\$
	RECOVERED	\$	\$	\$	\$	\$	\$	\$	\$
	26. PROPERTY	I. CONSUMABLES	J. LIVESTOCK	K. DRUGS	L. MARINE ITEMS	M. CONSTRUCTION ITEMS	N. LAWN AND GARDEN	O. SPORTING GOODS	P. MISC BICYCLE
	STOLEN	\$	\$	\$	\$	\$	\$	\$	\$
	RECOVERED	\$	\$	\$	\$	\$	\$	\$	\$

27. PROPERTY RECOVERED: LOCALLY _____ OTHER JURISDICTION _____ (INSERT O OR L)

PROPERTY ITEMIZATION	PROPERTY STOLEN/RECOVERED ITEMIZATION, USE THE FOLLOWING FORMAT				
	28. QUANTITY	29. ARTICLE NAME	30. BRAND NAME	31. SERIAL NUMBER	32. CODE
					S R <input type="checkbox"/> <input type="checkbox"/>
					S R <input type="checkbox"/> <input type="checkbox"/>
					S R <input type="checkbox"/> <input type="checkbox"/>
					S R <input type="checkbox"/> <input type="checkbox"/>

33. PROPERTY DAMAGE AMOUNT \$ _____ 34. INSURANCE COMPANY _____

35. OFFICER ASSAULTED Y N 36. ARSON Y N 37. STRUCTURE CODE _____ 38. DAMAGE \$ _____

47. CIB NCIC OTHER BROADCAST	ENTERED <input type="checkbox"/> <input type="checkbox"/> <input type="checkbox"/>	CANCELLED <input type="checkbox"/> <input type="checkbox"/> <input type="checkbox"/>	48. TOTAL AMOUNT PROPERTY STOLEN \$ _____
			49. TOTAL AMOUNT PROPERTY RECOVERED \$ _____

50. IS REPORT CONTINUED? YES NO 51. CAUTION INDICATORS, ATLS ETC.

52. DATA PROCESS INFORMATION:
 COMPUTER ENTERED DATE 2/8/99
 MICROFILM INDEXED INITIAL AS
 IS CASE CLASSIFICATION CORRECT? Y N
 IF N HAS CORRECTION BEEN MADE? Y N

53. FILE APPROVAL
 BY [Signature] DATE 2/16/99

1. CASE # S99 No 01373 2. CLASSIFICATION 6310.11 3. CENSUS 3,110.00

4. INCIDENT See S99-00242

6. NAME LAST-FIRST-MI 7. D.O.B.

9. TX-HOME

10. TX-BUSINESS

12. DETAILS SEE ATTACHED TRP846

SUBJ. DRIVING THIS VEH. IS LOOKING

TO PURCHASE A VAN GRILL (88 CHEV)

INFO REC'D FROM LT. HERMANN

02-16-99 1120

MANITOWOC COUNTY SHERIFF INCIDENT CARD			
18. ASSIGNED			
MISO CS.		929	
LT BUSHMAN		441	
19. REC. BY		20. DIS. BY	
930		930	
21. HOW REC'D.		22. TYPE OF REPORT	
1. 911		1. INCIDENT	
2. POLICE RADIO		2. ACCIDENT	
3. PHONE		3. CITATION	
4. TTY		4. NONE	
5. IN PERSON		23. STATUS	
6. ON VIEW		1. UNFOUNDED	
7. OFF. OFF DUTY		2. PNL	
8. C.B. RADIO		3. OTHER	
9. OTHER		4. CLEARED	
21A. M.O.		5. EXCEPT CLEARED	
		24. DATE CLEARED 030889	
		25. OFFENSE TYPE	
		1. ADULT <input type="checkbox"/> NA <input type="checkbox"/>	
		2. JUVENILE <input type="checkbox"/>	
		3. UNKNOWN <input type="checkbox"/>	

39. (CODE S-SUSPECT W-WITNESS V-VICTIM O-OTHER)			
CODE	40. NAME-LAST	FIRST	MI
0	Weisman Eric B	176249	
			41. D.O.B.
			42. ADDRESS
			S. 17th St. Sheboygan
			43. TELEPHONE

02/16/99 Cleveland Auto reports the above subject was in to attempt purchase of an 88 Chev. van grille. The second time a plate was obtained. Sheboygan PD phoned and asked for assistance. Off. familiar with the case attempted contact. He did not find Weisman but did view the 88 Chev van in question. The grille is for an upscale van with blue trim through the middle not a custom model. Most of the grille is in place with parts we're looking for still there. This is not our Vehicle. M.J. Bushman

C/C/O EN 660

45. IF COMPLAINANT DIFFERENT THEN CALLER, ENTER NAME, ADDRESS, D.O.B., TELEPHONE.

46. IF CODE O (OTHER) IS USED IN FIELD #39, EXPLAIN.

INCIDENT REPORT: NOTE: IF SECTION 22 ABOVE HAS NUMBER 4 CHECKED, DO NOT GO BEYOND THIS LINE WITHOUT RECORDS SECTION BEING ADVISED, OR NO RECORD ENTRIES WILL BE MADE BELOW THIS LINE.

PROPERTY VALUE	26. PROPERTY	A. CURRENCY	B. JEWELRY	C. FURS CLOTHING	D. VEHICLE (LOCAL)	E. OFFICE EQUIPMENT	F. RADIO, TV CAMERAS	G. FIREARMS	H. HOUSE-HOLD GOODS
	STOLEN	\$	\$	\$	\$	\$	\$	\$	\$
	RECOVERED	\$	\$	\$	\$	\$	\$	\$	\$
	26. PROPERTY	I. CONSUMABLES	J. LIVESTOCK	K. DRUGS	L. MARINE ITEMS	M. CONSTRUCTION ITEMS	N. LAWN AND GARDEN	O. SPORTING GOODS	P. MISC BICYCLE
STOLEN	\$	\$	\$	\$	\$	\$	\$	\$	
RECOVERED	\$	\$	\$	\$	\$	\$	\$	\$	

27. PROPERTY RECOVERED: LOCALLY _____ OTHER JURISDICTION _____ (INSERT O OR L)

PROPERTY ITEMIZATION	PROPERTY STOLEN/RECOVERED ITEMIZATION, USE THE FOLLOWING FORMAT				
	28. QUANTITY	29. ARTICLE NAME	30. BRAND NAME	31. SERIAL NUMBER	32. CODE
					S R <input type="checkbox"/> <input type="checkbox"/>
					S R <input type="checkbox"/> <input type="checkbox"/>
					S R <input type="checkbox"/> <input type="checkbox"/>
					S R <input type="checkbox"/> <input type="checkbox"/>

33. PROPERTY DAMAGE AMOUNT \$ _____

34. INSURANCE COMPANY _____

35. OFFICER ASSAULTED Y N

36. ARSON Y N

37. STRUCTURE CODE _____

38. DAMAGE \$ _____

47. CIB ENTERED CANCELLED
 NCIC
 OTHER BROADCAST

48. TOTAL AMOUNT PROPERTY STOLEN \$ _____

49. TOTAL AMOUNT PROPERTY RECOVERED \$ _____

50. IS REPORT CONTINUED? YES NO

51. CAUTION INDICATORS, ATLS ETC.

52. DATA PROCESS INFORMATION:

COMPUTER ENTERED DATE 3/8/99

MICROFILM INDEXED INITIAL AS

IS CASE CLASSIFICATION CORRECT? N
 IF N HAS CORRECTION BEEN MADE? Y N

53. FILE APPROVAL

BY [Signature] DATE 3/8/99

1. CASE # S99 No 01439 | 2. CLASSIFICATION 63011 | 3. CENSUS 701000

INCIDENT CS/599-00242
 INCIDENT LOCATION

6. NAME - LAST - FIRST - MI Anonymous | 7. D.O.B.

8. ADDRESS | 9. TX-HOME

11. CITY STATE ZIP | 10. TX-BUSINESS

12. DETAILS
 86-88 blue Chev P.U. w/gall
 & front end damage parked at
 Chuck Van Horn Dodge in Plymouth

021999 1200

14. REC'D. | 15. DISP. | 16. 10-23 | 17. 10-24

13. DAY
 SUN 1 THU 5
 MON 2 FRI 6
 TUE 3 SAT 7
 WED 4

MANITOWOC COUNTY SHERIFF
 INCIDENT CARD

18. ASSIGNED Jost 449
 939

19. REC. BY 903 | 20. DIS. BY

21. HOW REC'D.
 1. 911
 2. POLICE RADIO
 3. PHONE
 4. TTY
 5. IN PERSON
 6. ON VIEW
 7. OFF. OFF DUTY
 8. C.B. RADIO
 9. OTHER

22. TYPE OF REPORT
 1. INCIDENT
 2. ACCIDENT
 3. CITATION
 4. NONE

23. STATUS
 1. UNFOUNDED
 2. PNL
 3. OTHER
 4. CLEARED
 5. EXCEPT CLEARED

24. DATE CLEARED 03/08/99

25. OFFENSE TYPE
 1. ADULT NA
 2. JUVENILE
 3. UNKNOWN

39. (CODE S-SUSPECT W-WITNESS V-VICTIM O-OTHER)						
CODE	40. NAME-LAST	FIRST	MI	41. D.O.B.	42. ADDRESS	43. TELEPHONE
0	Manusich	David	A.		Monroe St. Sheboygan Falls	

02-19 -99 I, Deputy Jost, contacted David from Chuck Van Horn Dodge in Plymouth. He stated they repossessed the truck in October of 1998 and it was sold to a Randy Goldsmith from Sheboygan. David stated the truck could not have been driven due to clutch damage, this not being repaired until late January. Randy purchased the truck on January 11, the truck was stored at the dealership until then. JMJ

CASE # S99 No 01439

45. IF COMPLAINANT DIFFERENT THEN CALLER, ENTER NAME, ADDRESS, D.O.B., TELEPHONE.

46. IF CODE O (OTHER) IS USED IN FIELD #39, EXPLAIN.

INCIDENT REPORT: NOTE: IF SECTION 22 ABOVE HAS NUMBER 4 CHECKED, DO NOT GO BEYOND THIS LINE WITHOUT RECORDS SECTION BEING ADVISED; OR NO RECORD ENTRIES WILL BE MADE BELOW THIS LINE.

PROPERTY VALUE	26. PROPERTY	A. CURRENCY	B. JEWELRY	C. FURS CLOTHING	D. VEHICLE (LOCAL)	E. OFFICE EQUIPMENT	F. RADIO, TV CAMERAS	G. FIREARMS	H. HOUSE-HOLD GOODS
	STOLEN	\$	\$	\$	\$	\$	\$	\$	\$
	RECOVERED	\$	\$	\$	\$	\$	\$	\$	\$
	26. PROPERTY	I. CONSUMABLES	J. LIVESTOCK	K. DRUGS	L. MARINE ITEMS	M. CONSTRUCTION ITEMS	N. LAWN AND GARDEN	O. SPORTING GOODS	P. MISC BICYCLE
	STOLEN	\$	\$	\$	\$	\$	\$	\$	\$
	RECOVERED	\$	\$	\$	\$	\$	\$	\$	\$

27. PROPERTY RECOVERED: LOCALLY _____ OTHER JURISDICTION _____ (INSERT O OR L)

PROPERTY ITEMIZATION	PROPERTY STOLEN/RECOVERED ITEMIZATION, USE THE FOLLOWING FORMAT				
	28. QUANTITY	29. ARTICLE NAME	30. BRAND NAME	31. SERIAL NUMBER	32. CODE
					S R <input type="checkbox"/> <input type="checkbox"/>
					S R <input type="checkbox"/> <input type="checkbox"/>
					S R <input type="checkbox"/> <input type="checkbox"/>
					S R <input type="checkbox"/> <input type="checkbox"/>
					S R <input type="checkbox"/> <input type="checkbox"/>

33. PROPERTY DAMAGE AMOUNT \$ _____

34. INSURANCE COMPANY _____

35. OFFICER ASSAULTED Y N

36. ARSON Y N

37. STRUCTURE CODE _____

38. DAMAGE \$ _____

47. CIB ENTERED CANCELLED
 NCIC
 OTHER BROADCAST

48. TOTAL AMOUNT PROPERTY STOLEN \$ _____

49. TOTAL AMOUNT PROPERTY RECOVERED \$ _____

50. IS REPORT CONTINUED? YES NO

51. CAUTION INDICATORS, ATLS ETC.

52. DATA PROCESS INFORMATION:

COMPUTER ENTERED DATE 13.8.99
 MICROFILM INDEXED INITIAL AS

53. FILE APPROVAL

IS CASE CLASSIFICATION CORRECT? Y N
 IF N HAS CORRECTION BEEN MADE? Y N

BY *[Signature]* DATE 03.08.99

1. CASE # 99-01440
 2. CLASSIFICATION 6301
 3. CENSUS 14011

IDENT CS/S99-00242
 IDENT LOCATION

6. NAME - LAST - FIRST - MI Anon
 7. D.O.B.

8. ADDRESS
 9. TX-HOME

11. CITY STATE ZIP
 10. TX-BUSINESS

12. DETAILS
 Compl rec'd a call from Fred Vanserke at [redacted] he is looking for a grill and a right front door for a 93 GMC dk blue in color.

13.16 91.1
 14. REC'D
 15. DISP
 16. 10-23
 17. 10-24
 13. DAY
 SUN 1 THU 5
 MON 2 FRI 6
 TUE 3 SAT 7
 WED 4

MANITOWOC COUNTY SHERIFF
 INCIDENT CARD

18. ASSIGNED MTSO 91219
 Jost 449

19. REC. BY 926
 20. DIS. BY
 22. TYPE OF REPORT
 1. INCIDENT
 2. ACCIDENT
 3. CITATION
 4. NONE

21. HOW REC'D.
 1. 911
 2. POLICE RADIO
 3. PHONE
 4. TTY
 5. IN PERSON
 6. ON VIEW
 7. OFF. OFF DUTY
 8. C.B. RADIO
 9. OTHER
 21A.M.O.
 23. STATUS
 1. UNFOUNDED
 2. PNL
 3. OTHER
 4. CLEARED
 5. EXCEPT CLEARED
 24. DATE CLEARED 103108 1999
 25. OFFENSE TYPE
 1. ADULT NA
 2. JUVENILE
 3. UNKNOWN

39. (CODE S-SUSPECT W-WITNESS V-VICTIM O-OTHER)							
CODE	40. NAME-LAST	FIRST	MI	41. D.O.B.	42. ADDRESS	43. TELEPHONE	
0	Vanserke	39357	Frederick	G	[redacted] Dutch Rd. Manitowoc	[redacted]	

They located the parts, gave Mr. Vanserke a price, but no buy was negotiated at this time. as/926

On 02-19-99 I, Deputy Jost, made phone contact with Fred Vanserke. He informed me he was in the process of purchasing the vehicle from Pietroske. I inspected the truck, the damage not consistent, the vehicle was too new and the grill not the same. See S99-00242 for further information. No followup needed.

Jost
 MJJ

S99-01440

45. IF COMPLAINANT DIFFERENT THEN CALLER, ENTER NAME, ADDRESS, D.O.B., TELEPHONE.

46. IF CODE O (OTHER) IS USED IN FIELD #39, EXPLAIN.

INCIDENT REPORT: NOTE: IF SECTION 22 ABOVE HAS NUMBER 4 CHECKED, DO NOT GO BEYOND THIS LINE WITHOUT RECORDS SECTION BEING ADVISED, OR NO RECORD ENTRIES WILL BE MADE BELOW THIS LINE.

PROPERTY VALUE	26. PROPERTY	A. CURRENCY	B. JEWELRY	C. FURS CLOTHING	D. VEHICLE (LOCAL)	E. OFFICE EQUIPMENT	F. RADIO, TV CAMERAS	G. FIREARMS	H. HOUSE-HOLD GOODS
	STOLEN	\$	\$	\$	\$	\$	\$	\$	\$
	RECOVERED	\$	\$	\$	\$	\$	\$	\$	\$
	26. PROPERTY	I. CONSUM-ABLES	J. LIVESTOCK	K. DRUGS	L. MARINE ITEMS	M. CONSTRUCTION ITEMS	N. LAWN AND GARDEN	O. SPORTING GOODS	P. MISC BICYCLE
	STOLEN	\$	\$	\$	\$	\$	\$	\$	\$
	RECOVERED	\$	\$	\$	\$	\$	\$	\$	\$

27. PROPERTY RECOVERED: LOCALLY ____ OTHER JURISDICTION ____ (INSERT O OR L)

PROPERTY ITEMIZATION	PROPERTY STOLEN/RECOVERED ITEMIZATION, USE THE FOLLOWING FORMAT				
	28. QUANTITY	29. ARTICLE NAME	30. BRAND NAME	31. SERIAL NUMBER	32. CODE
					S R <input type="checkbox"/> <input type="checkbox"/>
					S R <input type="checkbox"/> <input type="checkbox"/>
					S R <input type="checkbox"/> <input type="checkbox"/>
					S R <input type="checkbox"/> <input type="checkbox"/>

33. PROPERTY DAMAGE AMOUNT \$ _____

34. INSURANCE COMPANY _____

35. OFFICER ASSAULTED Y N 36. ARSON Y N 37. STRUCTURE CODE _____ 38. DAMAGE \$ _____

47. CIB ENTERED CANCELLED
 NCIC
 OTHER BROADCAST

48. TOTAL AMOUNT PROPERTY STOLEN \$ _____

49. TOTAL AMOUNT PROPERTY RECOVERED \$ _____

50. IS REPORT CONTINUED? YES NO

51. CAUTION INDICATORS, ATLS ETC.

52. DATA PROCESS INFORMATION:

COMPUTER ENTERED DATE 3.8.99
 MICROFILM INDEXED INITIAL KS

53. FILE APPROVAL

IS CASE CLASSIFICATION CORRECT? Y N
 IF N HAS CORRECTION BEEN MADE? Y N

BY [Signature] DATE 03/08/99

1. CASE # S99 No 01455		2. CLASSIFICATION 1a3 Q1		3. CENSUS 52400		MANITOWOC COUNTY SHERIFF INCIDENT CARD																					
4. INCIDENT, / S99-00243												18. ASSIGNED MTSO 929 Colborn 432															
5. INCIDENT LOCATION						19. REC. BY 935						20. DIS. BY						22. TYPE OF REPORT 1. INCIDENT 2. ACCIDENT 3. CITATION 4. NONE									
6. NAME - LAST - FIRST - MI Anonymous				7. D.O.B.		8. ADDRESS		9. TX-HOME		11. CITY		STATE		ZIP		10. TX-BUSINESS		21. HOW REC'D. 1. 911 2. POLICE RADIO 3. PHONE 4. TTY 5. IN PERSON 6. ON VIEW 7. OFF. OFF DUTY 8. C.B. RADIO 9. OTHER									
12. DETAILS See Attached						14. REC'D		15. DISP		16. 10-23		17. 10-24		23. STATUS 1. UNFOUNDED 2. PNL 3. OTHER 4. CLEARED 5. EXCEPT CLEARED													
						13. DAY		SUN 1		THU 5		MON 2		FRI 6		TUE 3		SAT 7		WED 4		24. DATE CLEARED 031899					
						21A. M.O.						25. OFFENSE TYPE 1. ADULT <input type="checkbox"/> NA <input type="checkbox"/> 2. JUVENILE <input type="checkbox"/> 3. UNKNOWN <input type="checkbox"/>															

39. (CODE S-SUSPECT W-WITNESS V-VICTIM O-OTHER)												
CODE	40. NAME-LAST	FIRST	MI	41. D.O.B.	42. ADDRESS	43. TELEPHONE						

021999 1602 hrs: Per Deputy Colborn, vehicle has been checked numerous times and has been eliminated from suspect list. 935/lms

02/19/99: I, Deputy A. Colborn, advised MTSO Dispatch that this particular vehicle has been checked and has been found not to be the suspect vehicle in the fatal hit and run.

I also checked the FBI Rapid Start Quick Track system in the computer and found this vehicle has been entered and has been noted to be checked and found to not be a match.

No further action taken. ALColborn /bjc

CASE # S99 No 01455

45. IF COMPLAINANT DIFFERENT THEN CALLER, ENTER NAME, ADDRESS, D.O.B., TELEPHONE.

46. IF CODE O (OTHER) IS USED IN FIELD #39, EXPLAIN.

INCIDENT REPORT: NOTE: IF SECTION 22 ABOVE HAS NUMBER 4 CHECKED, DO NOT GO BEYOND THIS LINE WITHOUT RECORDS SECTION BEING ADVISED, OR NO RECORD ENTRIES WILL BE MADE BELOW THIS LINE.

PROPERTY VALUE	26. PROPERTY	A. CURRENCY	B. JEWELRY	C. FURS CLOTHING	D. VEHICLE (LOCAL)	E. OFFICE EQUIPMENT	F. RADIO, TV CAMERAS	G. FIREARMS	H. HOUSE-HOLD GOODS
	STOLEN	\$	\$	\$	\$	\$	\$	\$	\$
	RECOVERED	\$	\$	\$	\$	\$	\$	\$	\$
	26. PROPERTY	I. CONSUMABLES	J. LIVESTOCK	K. DRUGS	L. MARINE ITEMS	M. CONSTRUCTION ITEMS	N. LAWN AND GARDEN	O. SPORTING GOODS	P. MISC BICYCLE
	STOLEN	\$	\$	\$	\$	\$	\$	\$	\$
	RECOVERED	\$	\$	\$	\$	\$	\$	\$	\$

27. PROPERTY RECOVERED: LOCALLY _____ OTHER JURISDICTION _____ (INSERT O OR L)

PROPERTY ITEMIZATION	PROPERTY STOLEN/RECOVERED ITEMIZATION, USE THE FOLLOWING FORMAT				
	28. QUANTITY	29. ARTICLE NAME	30. BRAND NAME	31. SERIAL NUMBER	
					S <input type="checkbox"/> R <input type="checkbox"/>
					S <input type="checkbox"/> R <input type="checkbox"/>
					S <input type="checkbox"/> R <input type="checkbox"/>
					S <input type="checkbox"/> R <input type="checkbox"/>
					S <input type="checkbox"/> R <input type="checkbox"/>

33. PROPERTY DAMAGE AMOUNT \$ _____ 34. INSURANCE COMPANY _____

35. OFFICER ASSAULTED Y N 36. ARSON Y N 37. STRUCTURE CODE _____ 38. DAMAGE \$ _____

47. CIB	ENTERED <input type="checkbox"/>	CANCELLED <input type="checkbox"/>	48. TOTAL AMOUNT PROPERTY STOLEN \$ _____
NCIC	<input type="checkbox"/>	<input type="checkbox"/>	
OTHER BROADCAST	<input type="checkbox"/>	<input type="checkbox"/>	49. TOTAL AMOUNT PROPERTY RECOVERED \$ _____

50. IS REPORT CONTINUED? YES NO

51. CAUTION INDICATORS, ATLS ETC.

52. DATA PROCESS INFORMATION:

COMPUTER ENTERED DATE 13.5.99
 MICROFILM INDEXED INITIAL KS

53. FILE APPROVAL

IS CASE CLASSIFICATION CORRECT? Y N
 IF N HAS CORRECTION BEEN MADE? Y N

BY [Signature] DATE 23.5.99

1. CASE # **S99 No 01459** | 2. CLASSIFICATION **63011** | 3. CENSUS **52600**

4. INCIDENT **CS/399-00242**

INCIDENT LOCATION **CR**

5. NAME - LAST - FIRST - MI **ANONYMOUS** | 7. D.O.B.

8. ADDRESS | 9. TX-HOME

11. CITY | STATE | ZIP | 10. TX-BUSINESS

12. DETAILS
RPTS VEHICLE IN GARAGE ON S 37 ST, MANITOWOC W/ FRONT-ENDS DMG
SEE ATTACHED

1547
 2-19-99
 REC'D
 DISP
 10-23
 10-24
 13. DAY
 SUN 1 THU 5
 MON 2 **FRI 6**
 TUE 3 SAT-7
 WED 4

MANITOWOC COUNTY SHERIFF INCIDENT CARD

18. ASSIGNED
INFO | **91311**
929
849

19. REC. BY **939** | 20. DIS. BY

21. HOW REC'D.
 1. 911
 2. POLICE RADIO
 3. **PHONE**
 4. TTY
 5. IN PERSON
 6. ON VIEW
 7. OFF. OFF DUTY
 8. C.B. RADIO
 9. OTHER

22. TYPE OF REPORT
 1. INCIDENT
 2. ACCIDENT
 3. CITATION
 4. NONE

23. STATUS
 1. UNFOUNDED
 2. PNL
 3. OTHER
 4. CLEARED
 5. EXCEPT CLEARED

24. DATE CLEARED **03/08/99**

25. OFFENSE TYPE
 1. ADULT NA
 2. JUVENILE
 3. UNKNOWN

39. (CODE S-SUSPECT W-WITNESS V-VICTIM O-OTHER)							
CODE	40. NAME-LAST	FIRST	MI	41. D.O.B.	42. ADDRESS	43. TELEPHONE	
0	Rehme	39543	Joseph	T	█ S. 39th St. Manitowoc	█	

02-19-99 I, Deputy Jost, made contact with Joseph, who was using the suspected truck. The truck was a 1979 Chev truck RP # B353-233, registering to Eugene Rehme. Damage not consistent and the year does not fit. Grill was also a different style than the one we are searching for. *[Signature]*

PP 22.00

S99 No 01459

45. IF COMPLAINANT DIFFERENT THEN CALLER, ENTER NAME, ADDRESS, D.O.B., TELEPHONE.

46. IF CODE O (OTHER) IS USED IN FIELD #39, EXPLAIN.

INCIDENT REPORT: NOTE: IF SECTION 22 ABOVE HAS NUMBER 4 CHECKED, DO NOT GO BEYOND THIS LINE WITHOUT RECORDS SECTION BEING ADVISED, OR NO RECORD ENTRIES WILL BE MADE BELOW THIS LINE.

PROPERTY VALUE	26. PROPERTY	A. CURRENCY	B. JEWELRY	C. FURS CLOTHING	D. VEHICLE (LOCAL)	E. OFFICE EQUIPMENT	F. RADIO, TV CAMERAS	G. FIREARMS	H. HOUSE-HOLD GOODS
	STOLEN	\$	\$	\$	\$	\$	\$	\$	\$
	RECOVERED	\$	\$	\$	\$	\$	\$	\$	\$
	26. PROPERTY	I. CONSUMABLES	J. LIVESTOCK	K. DRUGS	L. MARINE ITEMS	M. CONSTRUCTION ITEMS	N. LAWN AND GARDEN	O. SPORTING GOODS	P. MISC BICYCLE
STOLEN	\$	\$	\$	\$	\$	\$	\$	\$	
RECOVERED	\$	\$	\$	\$	\$	\$	\$	\$	

27. PROPERTY RECOVERED: LOCALLY _____ OTHER JURISDICTION _____ (INSERT O OR L)

PROPERTY ITEMIZATION	PROPERTY STOLEN/RECOVERED ITEMIZATION, USE THE FOLLOWING FORMAT				
	28. QUANTITY	29. ARTICLE NAME	30. BRAND NAME	31. SERIAL NUMBER	32. CODE
					S <input type="checkbox"/> R <input type="checkbox"/>
					S <input type="checkbox"/> R <input type="checkbox"/>
					S <input type="checkbox"/> R <input type="checkbox"/>
					S <input type="checkbox"/> R <input type="checkbox"/>

33. PROPERTY DAMAGE AMOUNT \$ _____ 34. INSURANCE COMPANY _____

35. OFFICER ASSAULTED Y N 36. ARSON Y N 37. STRUCTURE CODE _____ 38. DAMAGE \$ _____

47. CIB	ENTERED <input type="checkbox"/>	CANCELLED <input type="checkbox"/>	48. TOTAL AMOUNT PROPERTY STOLEN \$ _____
NCIC	<input type="checkbox"/>	<input type="checkbox"/>	
OTHER BROADCAST	<input type="checkbox"/>	<input type="checkbox"/>	
			49. TOTAL AMOUNT PROPERTY RECOVERED \$ _____

50. IS REPORT CONTINUED? YES NO 51. CAUTION INDICATORS, ATLS ETC.

52. DATA PROCESS INFORMATION:

COMPUTER ENTERED DATE 13.8.99

MICROFILM INDEXED INITIAL KS

IS CASE CLASSIFICATION CORRECT? Y N

IF N HAS CORRECTION BEEN MADE? Y N

53. FILE APPROVAL

BY [Signature] DATE 03/28/99

1. CASE # **S99 No 01462** 2. CLASSIFICATION **631011** 3. CENSUS **141012**

4. INCIDENT **CS/S99-00242**

5. INCIDENT LOCATION **CR**

6. NAME - LAST - FIRST - MI **ANONYMOUS** 7. D.O.B.

8. ADDRESS 9. TX-HOME

11. CITY STATE ZIP 10. TX-BUSINESS

12. DETAILS **REPORTS PU w/ GRILLE MISSING**

PARKED ON EASTSIDE OF BARN ON

SW CORNER 26 SILVER CREEK RD

1805
2-
14. REC'D
15. DISP
16. 10-23
17. 10-24
13. DAY
SUN 1 THU 5
MON 2 **FRI 6**
TUE 3 SAT 7
WED 4

**MANITOWOC COUNTY SHERIFF
INCIDENT CARD**

18. ASSIGNED **INFORMATION** **9181**

929

449

19. REC BY **939** 20. DIS BY **939**

22. TYPE OF REPORT
1. INCIDENT
2. ACCIDENT
3. CITATION
4. NONE

21. HOW REC'D.
1. 911
2. POLICE RADIO
3. PHONE
4. TTY
5. IN PERSON
6. ON VIEW
7. OFF. OFF DUTY
8. C.B. RADIO
9. OTHER

23. STATUS
1. UNFOUNDED
2. PNL
3. OTHER
4. CLEARED
5. EXCEPT CLEARED

24. DATE CLEARED **03 08 99**

25. OFFENSE TYPE
1. ADULT NA
2. JUVENILE
3. UNKNOWN

21A. M.O.

39. (CODE S-SUSPECT W-WITNESS V-VICTIM O-OTHER)

CODE 40. NAME-LAST FIRST MI 41. D.O.B. 42. ADDRESS 43. TELEPHONE

02-19-99 I, Deputy Jost, received a phone call from dispatch reference the above vehicle. This truck would be the same truck Lt. Bushman inspected, RP # 22570F WI. No need for further follow-up. **BMJ**

03134

PROCESSED

CASE # **S99 No 01462**

45. IF COMPLAINANT DIFFERENT THEN CALLER, ENTER NAME, ADDRESS, D.O.B., TELEPHONE.

46. IF CODE O (OTHER) IS USED IN FIELD #39, EXPLAIN.

INCIDENT REPORT: NOTE: IF SECTION 22 ABOVE HAS NUMBER 4 CHECKED, DO NOT GO BEYOND THIS LINE WITHOUT RECORDS SECTION BEING ADVISED, OR NO RECORD ENTRIES WILL BE MADE BELOW THIS LINE.

PROPERTY VALUE	26. PROPERTY	A. CURRENCY	B. JEWELRY	C. FURS CLOTHING	D. VEHICLE (LOCAL)	E. OFFICE EQUIPMENT	F. RADIO, TV CAMERAS	G. FIREARMS	H. HOUSE-HOLD GOODS
	STOLEN	\$	\$	\$	\$	\$	\$	\$	\$
	RECOVERED	\$	\$	\$	\$	\$	\$	\$	\$
	26. PROPERTY	I. CONSUMABLES	J. LIVESTOCK	K. DRUGS	L. MARINE ITEMS	M. CONSTRUCTION ITEMS	N. LAWN AND GARDEN	O. SPORTING GOODS	P. MISC BICYCLE
STOLEN	\$	\$	\$	\$	\$	\$	\$	\$	
RECOVERED	\$	\$	\$	\$	\$	\$	\$	\$	

27. PROPERTY RECOVERED: LOCALLY _____ OTHER JURISDICTION _____ (INSERT O OR L)

PROPERTY ITEMIZATION	PROPERTY STOLEN/RECOVERED ITEMIZATION, USE THE FOLLOWING FORMAT				32. CODE	
	28. QUANTITY	29. ARTICLE NAME	30. BRAND NAME	31. SERIAL NUMBER	S	R
					<input type="checkbox"/>	<input type="checkbox"/>
					<input type="checkbox"/>	<input type="checkbox"/>
					<input type="checkbox"/>	<input type="checkbox"/>
					<input type="checkbox"/>	<input type="checkbox"/>
					<input type="checkbox"/>	<input type="checkbox"/>
					<input type="checkbox"/>	<input type="checkbox"/>

33. PROPERTY DAMAGE AMOUNT \$ _____ 34. INSURANCE COMPANY _____

35. OFFICER ASSAULTED Y N 36. ARSON Y N 37. STRUCTURE CODE _____ 38. DAMAGE \$ _____

47. CIB ENTERED CANCELLED
 NCIC
 OTHER BROADCAST

48. TOTAL AMOUNT PROPERTY STOLEN \$ _____

49. TOTAL AMOUNT PROPERTY RECOVERED \$ _____

50. IS REPORT CONTINUED? YES NO

51. CAUTION INDICATORS, ATLS ETC.

52. DATA PROCESS INFORMATION:

COMPUTER ENTERED DATE 13.8.99
 MICROFILM INDEXED INITIAL KS

53. FILE APPROVAL

IS CASE CLASSIFICATION CORRECT? N
 IF N HAS CORRECTION BEEN MADE? N

BY [Signature] DATE 13.8.99

1. CASE # **S99 No 01471** | 2. CLASSIFICATION **6,301** | 3. CENSUS **52000**

4. INCIDENT **CS/S99-0242**

5. INCIDENT LOCATION

6. NAME - LAST - FIRST - MI [REDACTED] | 7. D.O.B. [REDACTED]

ADDRESS [REDACTED] | 9. TX-HOME **NONE**

11. CITY [REDACTED] STATE [REDACTED] ZIP **120227** | 10. TX-BUSINESS

12. DETAILS
 caller states there was a black '79 pickup truck parked at Fleet Farm today at 5pm
 it left south bound on CTH CR. No plates on vehicle. Caller states vehicle was painted over w/a new grill and a dent in fender.

Feb 19, 1999 2131

MANITOWOC COUNTY SHERIFF INCIDENT CARD

18. ASSIGNED
Bushman 929
Colborn 441
 432

19. REC. BY **924** | 20. DIS. BY
 22. TYPE OF REPORT
 INCIDENT
 ACCIDENT
 CITATION
 NONE

21. HOW REC'D.
 1. 911
 2. POLICE RADIO
 3. PHONE
 4. TTY
 5. IN PERSON
 6. ON VIEW
 7. OFF. OFF DUTY
 8. C.B. RADIO
 OTHER

23. STATUS
 1. UNFOUNDED
 2. PNL
 OTHER
 4. CLEARED
 5. EXCEPT CLEARED

24. DATE CLEARED **03/08/99**

25. OFFENSE TYPE
 1. ADULT NA
 2. JUVENILE
 3. UNKNOWN

39. (CODE S-SUSPECT W-WITNESS V-VICTIM O-OTHER)				42. ADDRESS		43. TELEPHONE	
CODE	40. NAME-LAST	FIRST	MI	41. D.O.B.			

States he knows officer COLBORN quite well and if he has any questions he can stop over. kc/924
 02/22/99 1545hrs Contact was made in person by Off.Colborn. The vehicle was described as being of the high mounted body with large oversize tires. After speaking with the complainant at length Off.Colborn felt this is not the vehicle we are looking for. Close Out this Complaint. M.J.Bushman

S99 No 01471

45. IF COMPLAINANT DIFFERENT THEN CALLER, ENTER NAME, ADDRESS, D.O.B., TELEPHONE.

46. IF CODE O (OTHER) IS USED IN FIELD #39, EXPLAIN.

INCIDENT REPORT: NOTE: IF SECTION 22 ABOVE HAS NUMBER 4 CHECKED, DO NOT GO BEYOND THIS LINE WITHOUT RECORDS SECTION BEING ADVISED, OR NO RECORD ENTRIES WILL BE MADE BELOW THIS LINE.

PROPERTY VALUE	26. PROPERTY	A. CURRENCY	B. JEWELRY	C. FURS CLOTHING	D. VEHICLE (LOCAL)	E. OFFICE EQUIPMENT	F. RADIO, TV CAMERAS	G. FIREARMS	H. HOUSE-HOLD GOODS
	STOLEN	\$	\$	\$	\$	\$	\$	\$	\$
	RECOVERED	\$	\$	\$	\$	\$	\$	\$	\$
	26. PROPERTY	I. CONSUMABLES	J. LIVESTOCK	K. DRUGS	L. MARINE ITEMS	M. CONSTRUCTION ITEMS	N. LAWN AND GARDEN	O. SPORTING GOODS	P. MISC BICYCLE
STOLEN	\$	\$	\$	\$	\$	\$	\$	\$	
RECOVERED	\$	\$	\$	\$	\$	\$	\$	\$	

27. PROPERTY RECOVERED: LOCALLY ____ OTHER JURISDICTION ____ (INSERT O OR L)

PROPERTY ITEMIZATION	PROPERTY STOLEN/RECOVERED ITEMIZATION, USE THE FOLLOWING FORMAT				
	28. QUANTITY	29. ARTICLE NAME	30. BRAND NAME	31. SERIAL NUMBER	32. CODE
					S <input type="checkbox"/> R <input type="checkbox"/>
					S <input type="checkbox"/> R <input type="checkbox"/>
					S <input type="checkbox"/> R <input type="checkbox"/>
					S <input type="checkbox"/> R <input type="checkbox"/>

33. PROPERTY DAMAGE AMOUNT \$ _____

34. INSURANCE COMPANY _____

35. OFFICER ASSAULTED Y N

36. ARSON Y N

37. STRUCTURE CODE _____

38. DAMAGE \$ _____

47. CIB

NCIC

OTHER BROADCAST

ENTERED

CANCELLED

48. TOTAL AMOUNT PROPERTY STOLEN \$ _____

49. TOTAL AMOUNT PROPERTY RECOVERED \$ _____

50. IS REPORT CONTINUED? YES NO

51. CAUTION INDICATORS, ATLS ETC.

52. DATA PROCESS INFORMATION:

COMPUTER ENTERED

DATE

3.9.99

MICROFILM INDEXED

INITIAL

KS

IS CASE CLASSIFICATION CORRECT?
IF N HAS CORRECTION BEEN MADE?

Y N

53. FILE APPROVAL

BY

[Signature]

DATE

03.08.99

1. CASE # S99 No 01482 2. CLASSIFICATION C301 C01000 3. CENSUS

4. INCIDENT # S/599-00242

5. INCIDENT LOCATION

6. NAME LAST FIRST MI 7. D.O.B.

8. ADDRESS 9. TX-HOME

11. CITY STATE ZIP 10. TX-BUSINESS

12. DETAILS
 Subj. on radio last week Sat (2/13) was dismantling a Chev. 400 parts to sell. Subj. sounded nervous, said name was Dave, and gave TX

0932
022099

MANITOWOC COUNTY SHERIFF INCIDENT CARD

18. ASSIGNED
 MTSO CS 929
 Colborn 4132

19. REC. BY 20. DIS. BY
 920

21. HOW REC'D.
 1. 911
 2. POLICE RADIO
 3. PHONE
 4. TTY
 5. IN PERSON
 6. ON VIEW
 7. OFF. OFF DUTY
 8. C.B. RADIO
 9. OTHER

22. TYPE OF REPORT
 1. INCIDENT
 2. ACCIDENT
 3. CITATION
 4. NONE

23. STATUS
 1. UNFOUNDED
 2. PNL
 3. OTHER
 4. CLEARED
 5. EXCEPT CLEARED

24. DATE CLEARED 03/18/99
 25. OFFENSE TYPE
 1. ADULT NA
 2. JUVENILE
 3. UNKNOWN

13. DAY
 SUN 1 THU 5
 MON 2 FRI 6
 TUE 3 SAT 7
 WED 4

39. (CODE S-SUSPECT W-WITNESS V-VICTIM O-OTHER)	40. NAME-LAST	FIRST	MI	41. D.O.B.	42. ADDRESS	43. TELEPHONE
0	[REDACTED]	104129	[REDACTED]	[REDACTED]	[REDACTED]	[REDACTED]
0	KRUEGER	4260	DAVID	H	[REDACTED] Tower Ave, Cato	[REDACTED]
0	KOHLBECK	22738	KENNETH	F	[REDACTED] Tower Ave, Keilnersville	[REDACTED]
0	RUZEK	38984	JOSEPH JR	*NMI*	[REDACTED] CTH K, Cato	[REDACTED]

02-20-99 Caller did try the [REDACTED] phone number today, and states it's been disconnected.
 Caller called back to leave his name and phone number in case we need to re-contact him. sbraun920

02/20/99: I, Deputy A. Colborn, was assigned this Crime Stopper incident for further investigation by MTSO Dispatch. Dispatch advised [REDACTED] called them and stated a party by the first name of "DAVE" was trying to sell Chevrolet truck parts on the WOMET Air Exchange Program. [REDACTED] informed Dispatch DAVE sounded very nervous while on the Air Exchange.

I attempted to call the number which [REDACTED] gave. [REDACTED] stated DAVE left a number of [REDACTED] where DAVE could be contacted should anyone be interested in the Chevrolet truck parts. I found this number was disconnected. Dispatch further advised me the number was not in the reverse directory.

I then contacted an employee of WOMET who I know personally. I know this employee to frequently be the disc jockey who conducts the Air Exchange Program. This employee informed me WOMET does not record the Air Exchange. This employee further informed me any cards or letters sent to WOMET to read on the Air Exchange are thrown out after the Air Exchange is over. This employee informed me there would be no record at WOMET of DAVE'S call.

I contacted GTE TELEPHONE COMPANY as this is the telephone company who services the [REDACTED] exchange. They informed me they could not provide the name of the last person who had the phone number of [REDACTED] as it was "a weekend and they could not verify that I was a police officer." I was advised to call their Security Division at [REDACTED] on a weekday and that they would be able to "perhaps" help me.

02/22/99: I received a telephone call at my residence from the employee of WOMET. This employee advised me he was doing the Air Exchange earlier today and DAVE again contacted WOMET about selling Chevrolet truck parts. This employee of WOMET stated DAVE left a phone

S99 No 01482

45. IF COMPLAINANT DIFFERENT THEN CALLER, ENTER NAME, ADDRESS, D.O.B., TELEPHONE.

46. IF CODE O (OTHER) IS USED IN FIELD #39, EXPLAIN.

INCIDENT REPORT: NOTE: IF SECTION 22 ABOVE HAS NUMBER 4 CHECKED, DO NOT GO BEYOND THIS LINE WITHOUT RECORDS SECTION BEING ADVISED, OR NO RECORD ENTRIES WILL BE MADE BELOW THIS LINE.

PROPERTY VALUE	26. PROPERTY	A. CURRENCY	B. JEWELRY	C. FURS CLOTHING	D. VEHICLE (LOCAL)	E. OFFICE EQUIPMENT	F. RADIO, TV CAMERAS	G. FIREARMS.	H. HOUSE-HOLD GOODS
	STOLEN	\$	\$	\$	\$	\$	\$	\$	\$
	RECOVERED	\$	\$	\$	\$	\$	\$	\$	\$
	26. PROPERTY	I. CONSUM-ABLES	J. LIVESTOCK	K. DRUGS	L. MARINE ITEMS	M. CONSTRUCTION ITEMS	N. LAWN AND GARDEN	O. SPORTING GOODS	P. MISC BICYCLE
	STOLEN	\$	\$	\$	\$	\$	\$	\$	\$
	RECOVERED	\$	\$	\$	\$	\$	\$	\$	\$

27. PROPERTY RECOVERED: LOCALLY _____ OTHER JURISDICTION _____ (INSERT O OR L)

PROPERTY ITEMIZATION	PROPERTY STOLEN/RECOVERED ITEMIZATION, USE THE FOLLOWING FORMAT				
	28. QUANTITY	29. ARTICLE NAME	30. BRAND NAME	31. SERIAL NUMBER	32. CODE
					S R <input type="checkbox"/> <input type="checkbox"/>
					S R <input type="checkbox"/> <input type="checkbox"/>
					S R <input type="checkbox"/> <input type="checkbox"/>
					S R <input type="checkbox"/> <input type="checkbox"/>
					S R <input type="checkbox"/> <input type="checkbox"/>

33. PROPERTY DAMAGE AMOUNT \$ _____ 34. INSURANCE COMPANY _____

35. OFFICER ASSAULTED Y N 36. ARSON Y N 37. STRUCTURE CODE _____ 38. DAMAGE \$ _____

47. CIB	ENTERED <input type="checkbox"/>	CANCELLED <input type="checkbox"/>	48. TOTAL AMOUNT PROPERTY STOLEN \$ _____
NCIC	<input type="checkbox"/>	<input type="checkbox"/>	
OTHER BROADCAST	<input type="checkbox"/>	<input type="checkbox"/>	
			49. TOTAL AMOUNT PROPERTY RECOVERED \$ _____

50. IS REPORT CONTINUED? YES NO

51. CAUTION INDICATORS, ATLS ETC.

52. DATA PROCESS INFORMATION:

COMPUTER ENTERED DATE 3.8.99
 MICROFILM INDEXED INITIAL JS

53. FILE APPROVAL

IS CASE CLASSIFICATION CORRECT? Y N
 IF N HAS CORRECTION BEEN MADE? Y N

BY [Signature] DATE 03.08.99

MANITOWOC COUNTY SHERIFF'S DEPARTMENT
FOLLOW-UP REPORT

Page: 2

CASE NUMBER: 599-01482 CLASSIFICATION: _____

INCIDENT: _____

DATE AND TIME: _____

REPORT CONTINUED:

number of [REDACTED] where he could be contacted.

02/22/99 @ 1000 Hrs.: I, Deputy Colborn, had MTSO Dispatch look up the telephone number of [REDACTED] in the reverse directory. This telephone number is for KENNETH KOHLBECK at [REDACTED] Tower Ave, Keilnersville. It should be noted KOHLBECK is the owner of KOHLBECK FARMS.

I contacted this phone number and spoke with KOHLBECK. He informed me KOHLBECK FARMS has an employee by the name of DAVID "DAVE" KRUEGER. KOHLBECK stated KRUEGER was the one who placed the telephone call to WOMT in hopes of selling Chevrolet truck parts from his truck.

I located KRUEGER at another portion of KOHLBECK FARMS located on Fischerville Rd, east of CTH T. KRUEGER informed me he was parting out a 1977 Chevrolet pickup truck. KRUEGER stated this was the vehicle which he contacted the Air Exchange in reference to selling parts from. KRUEGER informed me I could observe the vehicle at JOSEPH RUZEK'S service station on CTH K, just west of I-43. I knew from prior contact where this garage was located, and I then responded there.

I observed sitting right in front of JOSEPH RUZEK'S garage, a 2-tone brown/tan Chevrolet pickup truck bearing VIN [REDACTED]. I observed this vehicle to have been manufactured in January 1977. I further observed this vehicle to have no structural front end damage, and the grill was whole and intact.

I made contact with RUZEK who informed me this was the vehicle which had been dropped off at his garage by DAVID KRUEGER. RUZEK stated he need to pull the engine out of the 1977 Chevrolet truck and put it in a 1973 Chevrolet truck which also had been brought there. I observed this truck also to bare no front end damage. RUZEK further stated the 2-tone brown/tan Chevrolet truck was the truck which KRUEGER was trying to sell parts from.

This vehicle does not match the suspect vehicle for the fatal hit and run. No further action taken at this time on this incident. ALColborn /bjc

1. CASE # 599 No 01483 2. CLASSIFICATION 63011 3. CENSUS 70000

4. INCIDENT 15/599-00242

5. INCIDENT LOCATION Darby - outagamie county

6. NAME - LAST - FIRST - MI OUSO 7. D.O.B.

8. ADDRESS 9. TX-HOME

11. CITY STATE ZIP 10. TX-BUSINESS

12. DETAILS
 190 chev, SVD 532, in Darby.
 Yel. it blue.
 Res phone call found OUSO, no
 grill or windshield damage.

722099 0914

14. REC'D.	15. DISP.	16. 10-23	17. 10-24
13. DAY			
SUN 1	THU 5		
MON 2	FRI 6		
TUE 3	SAT 7		
WED 4			

MANITOWOC COUNTY SHERIFF
INCIDENT CARD

18. ASSIGNED
 Bushman 441

19. REC. BY 920 20. DIS. REPORT

21. HOW REC'D.
 1. 911
 2. POLICE RADIO
 3. PHONE
 4. TTY
 5. IN PERSON
 6. ON VIEW
 7. OFF. OFF DUTY
 8. C.B. RADIO
 9. OTHER

22. INCIDENT ACCIDENT
 3. CITATION
 4. NONE

23. STATUS
 1. UNFOUNDED
 2. PNL
 3. OTHER
 4. CLEARED
 5. EXCEPT CLEARED

24. DATE CLEARED 030899

25. OFFENSE TYPE
 1. ADULT NA
 2. JUVENILE
 3. UNKNOWN

39. (CODE S-SUSPECT W-WITNESS V-VICTIM O-OTHER)				42. ADDRESS	43. TELEPHONE
CODE	40. NAME-LAST	FIRST	MI	41. D.O.B.	

02/22/99 The vehicle described above is a 1990 Chev. Cav., not even close to the type vehicle we are looking for, and it was checked out by a Outagamie Co. Officer. It is old damage, no grille or windshield damage, not a suspect vehicle. M.J. Bushman

45. IF COMPLAINANT DIFFERENT THEN CALLER, ENTER NAME, ADDRESS, D.O.B., TELEPHONE.

46. IF CODE O (C.) ENTERED IN FIELD #39, EXPLAIN.

INCIDENT REPORT: NOTE: IF SECTION 22 ABOVE HAS NUMBER 4 CHECKED, DO NOT GO BEYOND THIS LINE WITHOUT RECORDS SECTION BEING ADVISED, OR NO RECORD ENTRIES WILL BE MADE BELOW THIS LINE.

PROPERTY VALUE	26. PROPERTY	A. CURRENCY	B. JEWELRY	C. FURS CLOTHING	D. VEHICLE (LOCAL)	E. OFFICE EQUIPMENT	F. RADIO, TV CAMERAS	G. FIREARMS	H. HOUSE-HOLD GOODS
	STOLEN	\$	\$	\$	\$	\$	\$	\$	\$
	RECOVERED	\$	\$	\$	\$	\$	\$	\$	\$
	26. PROPERTY	I. CONSUMABLES	J. LIVESTOCK	K. DRUGS	L. MARINE ITEMS	M. CONSTRUCTION ITEMS	N. LAWN AND GARDEN	O. SPORTING GOODS	P. MISC BICYCLE
	STOLEN	\$	\$	\$	\$	\$	\$	\$	\$
	RECOVERED	\$	\$	\$	\$	\$	\$	\$	\$

27. PROPERTY RECOVERED: LOCALLY ____ OTHER JURISDICTION ____ (INSERT O OR L)

PROPERTY ITEMIZATION	PROPERTY STOLEN/RECOVERED ITEMIZATION, USE THE FOLLOWING FORMAT				
	28. QUANTITY	29. ARTICLE NAME	30. BRAND NAME	31. SERIAL NUMBER	
					S R <input type="checkbox"/> <input type="checkbox"/>
					S R <input type="checkbox"/> <input type="checkbox"/>
					S R <input type="checkbox"/> <input type="checkbox"/>
					S R <input type="checkbox"/> <input type="checkbox"/>

33. PROPERTY DAMAGE AMOUNT \$ _____

34. INSURANCE COMPANY _____

35. OFFICER ASSAULTED Y N

36. ARSON Y N

37. STRUCTURE CODE _____

38. DAMAGE \$ _____

47. CIB ENTERED CANCELLED
 NCIC
 OTHER BROADCAST

48. TOTAL AMOUNT PROPERTY STOLEN \$ _____

49. TOTAL AMOUNT PROPERTY RECOVERED \$ _____

50. IS REPORT CONTINUED? YES NO

51. CAUTION INDICATORS, ATLS ETC.

52. DATA PROCESS INFORMATION:

COMPUTER ENTERED DATE 10/15/99

MICROFILM INDEXED INITIAL KS

IS CASE CLASSIFICATION CORRECT? N
 IF N HAS CORRECTION BEEN MADE? N

53. FILE APPROVAL

BY [Signature] DATE 10/15/99

1. CASE # S99 No 01484 | 2. CLASSIFICATION 63011 | 3. CENSUS 70000

4. INCIDENT CS/599-00242

5. INCIDENT LOCATION Winnebago Co. 45/4

6. NAME - LAST - FIRST - MI WJSD | 7. D.O.B.

8. ADDRESS [REDACTED] | 9. TX-HOME

11. STATE ZIP | 10. TX-BUSINESS

12. DETAILS
 Blk/grey Chev. Blazer w/ front end damage & grill covered w/ blk tarp, #BJ 75165.

020999 1509
 6051
 63620

MANITOWOC COUNTY SHERIFF
INCIDENT CARD

18. ASSIGNED
 Janssen
 4/4
 929

19. REC. BY 929 | 20. DIS. BY
 22. TYPE OF REPORT
 1. INCIDENT
 2. ACCIDENT
 3. CITATION
 4. NONE

21. HOW REC'D.
 1. 911
 2. POLICE RADIO
 3. PHONE
 4. TTY
 5. IN PERSON
 6. ON VIEW
 7. OFF. OFF DUTY
 8. C.B. RADIO
 9. OTHER
 23. STATUS
 1. UNFOUNDED
 2. PNL
 3. OTHER
 4. CLEARED
 5. EXCEPT CLEARED
 24. DATE CLEARED 03/08/99

25. OFFENSE TYPE
 1. ADULT NA
 2. JUVENILE
 3. UNKNOWN

14. REC'D
 15. DISP
 16. 10-23
 17. 10-24
 13. DAY
 SUN 1 THU 5
 MON 2 FR 6
 TUE 3 SAT 7
 WED 4

39. (CODE S-SUSPECT W-WITNESS V-VICTIM O-OTHER)

CODE	40. NAME - LAST	FIRST	MI	41. D.O.B.	42. ADDRESS	43. TELEPHONE

talked with Winnebago officer at length...not the vehicle we are looking for

45. IF COMPLAINANT DIFFERENT THEN CALLER, ENTER NAME, ADDRESS, D.O.B., TELEPHONE.

46. IF CODE O (OTHER) IS USED IN FIELD #39, EXPLAIN.

INCIDENT REPORT: NOTE: IF SECTION 22 ABOVE HAS NUMBER 4 CHECKED, DO NOT GO BEYOND THIS LINE WITHOUT RECORDS SECTION BEING ADVISED, OR NO RECORD ENTRIES WILL BE MADE BELOW THIS LINE.

PROPERTY VALUE	26. PROPERTY	A. CURRENCY	B. JEWELRY	C. FURS CLOTHING	D. VEHICLE (LOCAL)	E. OFFICE EQUIPMENT	F. RADIO, TV CAMERAS	G. FIREARMS	H. HOUSE-HOLD GOODS
	STOLEN	\$	\$	\$	\$	\$	\$	\$	\$
	RECOVERED	\$	\$	\$	\$	\$	\$	\$	\$
	26. PROPERTY	I. CONSUMABLES	J. LIVESTOCK	K. DRUGS	L. MARINE ITEMS	M. CONSTRUCTION ITEMS	N. LAWN AND GARDEN	O. SPORTING GOODS	P. MISC BICYCLE
	STOLEN	\$	\$	\$	\$	\$	\$	\$	\$
	RECOVERED	\$	\$	\$	\$	\$	\$	\$	\$

27. PROPERTY RECOVERED: LOCALLY ____ OTHER JURISDICTION ____ (INSERT O OR L)

PROPERTY ITEMIZATION	PROPERTY STOLEN/RECOVERED ITEMIZATION, USE THE FOLLOWING FORMAT				
	28. QUANTITY	29. ARTICLE NAME	30. BRAND NAME	31. SERIAL NUMBER	32. CODE
					S R <input type="checkbox"/> <input type="checkbox"/>
					S R <input type="checkbox"/> <input type="checkbox"/>
					S R <input type="checkbox"/> <input type="checkbox"/>
					S R <input type="checkbox"/> <input type="checkbox"/>
					S R <input type="checkbox"/> <input type="checkbox"/>

33. PROPERTY DAMAGE AMOUNT \$ _____ 34. INSURANCE COMPANY _____

35. OFFICER ASSAULTED Y N 36. ARSON Y N 37. STRUCTURE CODE _____ 38. DAMAGE \$ _____

47. CIB ENTERED CANCELLED
 NCIC
 OTHER BROADCAST

48. TOTAL AMOUNT PROPERTY STOLEN \$ _____

49. TOTAL AMOUNT PROPERTY RECOVERED \$ _____

50. IS REPORT CONTINUED? YES NO

51. CAUTION INDICATORS, ATLS ETC.

52. DATA PROCESS INFORMATION:

COMPUTER ENTERED DATE 13.8.99
 MICROFILM INDEXED INITIAL XS

53. FILE APPROVAL

IS CASE CLASSIFICATION CORRECT? N
 IF N HAS CORRECTION BEEN MADE? N

BY [Signature] DATE 03/08/99

1. CASE # S99 No 01502 | 2. CLASSIFICATION 631011 | 3. CENSUS 521000

4. INCIDENT 05/S99-00242

5. INCIDENT LOCATION Junk N or S just out of City

6. NAME LAST FIRST MI D.O.B.

8. ADDRESS

11. CITY STATE ZIP 10. TX-BUSINESS

DETAILS
 (Caller) states there was a van that did go into ditch above loc. perhaps on purpose to have similar damage.

1300 022199

14. REC'D 15. DISP 16. 10-23 17. 10-24
 13. DAY
 (SUN) THU 5
 MON 2 FRI 6
 TUE 3 SAT 7
 WED 4

MANITOWOC COUNTY SHERIFF INCIDENT CARD

18. ASSIGNED 929
 Bushman H.H.V.

19. REC. BY 922 NA 20. DIS. BY NA

21. HOW REC'D.
 1. 911
 2. POLICE RADIO PHONE C.S.
 3. TTY
 4. IN PERSON
 5. ON VIEW
 6. OFF. OFF DUTY
 7. C.B. RADIO
 8. OTHER

22. TYPE OF REPORT
 1. INCIDENT
 2. ACCIDENT
 3. CITATION
 4. NONE
 23. STATUS
 1. UNFOUNDED
 2. PNL
 3. OTHER
 4. CLEARED
 5. EXCEPT CLEARED

24. DATE CLEARED 03/08/99

25. OFFENSE TYPE
 1. ADULT NA
 2. JUVENILE
 3. UNKNOWN

21A. M.O.

39. (CODE S-SUSPECT W-WITNESS V-VICTIM O-OTHER)				42. ADDRESS		43. TELEPHONE	
CODE	40. NAME-LAST	FIRST	MI	41. D.O.B.			

02/22/99 1430hrs Contact made by phone with Complainant [redacted]. He stated his memory is poor due to a stroke and has forgotten to call MTSO on several other occasions. But he wished to report that approximately 2-3 days after the accident he saw in the paper that a van was in the ditch North or South of Manitowoc and it had damage. He said we were not immediately looking for a van but later discovered it may be a van. He has no idea where this occurred and did not see it stating; "Its only a hunch."

All accident reports were checked from 01/09/99 through 01/23/99. None of the vehicles listed in the reports matched the suspect vehicle with a 94 Ford Custom Van Southbound on I-43 listed 01/12/99. This may have been the van he was talking about which was listed in the Herald-Times Sheriff daily log. M.J. Bushman
 Close out report.

CASE # S99 No 01502

45. IF COMPLAINANT DIFFERENT THEN CALLER, ENTER NAME, ADDRESS, D.O.B., TELEPHONE.

46. IF CODE O (OTHER) IS USED IN FIELD #39, EXPLAIN.

INCIDENT REPORT: NOTE: IF SECTION 22 ABOVE HAS NUMBER 4 CHECKED, DO NOT GO BEYOND THIS LINE WITHOUT RECORDS SECTION BEING ADVISED, OR NO RECORD ENTRIES WILL BE MADE BELOW THIS LINE.

PROPERTY VALUE	26. PROPERTY	A. CURRENCY	B. JEWELRY	C. FURS CLOTHING	D. VEHICLE (LOCAL)	E. OFFICE EQUIPMENT	F. RADIO, TV, CAMERAS	G. FIREARMS	H. HOUSE-HOLD GOODS
	STOLEN	\$	\$	\$	\$	\$	\$	\$	\$
	RECOVERED	\$	\$	\$	\$	\$	\$	\$	\$
	26. PROPERTY	I. CONSUMABLES	J. LIVESTOCK	K. DRUGS	L. MARINE ITEMS	M. CONSTRUCTION ITEMS	N. LAWN AND GARDEN	O. SPORTING GOODS	P. MISC BICYCLE
	STOLEN	\$	\$	\$	\$	\$	\$	\$	\$
	RECOVERED	\$	\$	\$	\$	\$	\$	\$	\$

27. PROPERTY RECOVERED: LOCALLY ____ OTHER JURISDICTION ____ (INSERT O OR L)

PROPERTY ITEMIZATION	PROPERTY STOLEN/RECOVERED ITEMIZATION, USE THE FOLLOWING FORMAT				
	28. QUANTITY	29. ARTICLE NAME	30. BRAND NAME	31. SERIAL NUMBER	32. CODE
					S R <input type="checkbox"/> <input type="checkbox"/>
					S R <input type="checkbox"/> <input type="checkbox"/>
					S R <input type="checkbox"/> <input type="checkbox"/>
					S R <input type="checkbox"/> <input type="checkbox"/>
					S R <input type="checkbox"/> <input type="checkbox"/>

33. PROPERTY DAMAGE AMOUNT \$ _____

34. INSURANCE COMPANY _____

35. OFFICER ASSAULTED Y N 36. ARSON Y N 37. STRUCTURE CODE _____ 38. DAMAGE \$ _____

47. CIB ENTERED CANCELLED
 NCIC
 OTHER BROADCAST

48. TOTAL AMOUNT PROPERTY STOLEN \$ _____

49. TOTAL AMOUNT PROPERTY RECOVERED \$ _____

50. IS REPORT CONTINUED? YES NO

51. CAUTION INDICATORS, ATLS ETC.

52. DATA PROCESS INFORMATION:

COMPUTER ENTERED DATE 3/8/99
 MICROFILM INDEXED INITIAL KS

53. FILE APPROVAL

IS CASE CLASSIFICATION CORRECT? N
 IF N HAS CORRECTION BEEN MADE? N

BY [Signature] DATE 2/3/99

ENT 3/ S99-00242

5. INCIDENT LOCATION
 CTH CR

6. NAME - LAST - FIRST - MI
 ANONYMOUS (2)

7. D.O.B.

8. ADDRESS

9. TX-HOME

10. TX-BUSINESS

11. CITY STATE ZIP

12. DETAILS
 CALLER BELIEVES HE MAY HAVE
 RECENTLY PURCHASED VEH INVOLVED
 IN HELL ACCIDENT.

184

2-21-99

14. REC'D

15. DISP

16. 10-23

17. 10-24

13. DAY
 SUN 1 THU 5
 MON 2 FRI 6
 TUE 3 SAT 7
 WED 4

18. ASSIGNED
 MTSO
 (Bushman) 9/2/9

19. REC. BY
 932

20. DIS. BY
 932

21. HOW REC'D.
 1. 911
 2. POLICE RADIO
 3. PHONE
 4. TTY
 5. IN PERSON
 6. ON VIEW
 7. OFF. OFF DUTY
 8. C.B. RADIO
 9. OTHER

22. TYPE OF REPORT
 1. INCIDENT
 2. ACCIDENT
 3. CITATION
 4. NONE

23. STATUS
 1. UNFOUNDED
 2. PNL
 3. OTHER
 4. CLEARED
 5. EXCEPT CLEARED

24. DATE CLEARED
 03/08/99

25. OFFENSE TYPE
 1. ADULT NA
 2. JUVENILE
 3. UNKNOWN

39. (CODE S-SUSPECT W-WITNESS V-VICTIM O-OTHER)

CODE	40. NAME-LAST	FIRST	MI	41. D.O.B.	42. ADDRESS	43. TELEPHONE

Per SC on duty, this report can wait until Lt. Bushman is next on duty. 932/mh
 02/22/99 1039hrs Contact by phone made with [REDACTED] and he described the vehicle he
 had purchased. He was in the garage working on the vehicle as we talked. Tires appeared
 to belong on vehicle for extended period of time, they were 10½ inches wide aggressive
 mud tires. The vehicle was raised higher than factory build, had round headlamps, and
 rounded corners on the missing grille parts. This does not describe the suspect vehicle.
 Close complaint. M.J. Bushman

S99 N9 01509

45. IF COMPLAINANT DIFFERENT THEN CALLER, ENTER NAME, ADDRESS, D.O.B., TELEPHONE.

46. IF CODE O (OTHER) IS USED IN FIELD #39, EXPLAIN.

INCIDENT REPORT: NOTE: IF SECTION 22 ABOVE HAS NUMBER 4 CHECKED, DO NOT GO BEYOND THIS LINE WITHOUT RECORDS SECTION BEING ADVISED, OR NO RECORD ENTRIES WILL BE MADE BELOW THIS LINE.

PROPERTY VALUE	26. PROPERTY	A. CURRENCY	B. JEWELRY	C. FURS CLOTHING	D. VEHICLE (LOCAL)	E. OFFICE EQUIPMENT	F. RADIO, TV CAMERAS	G. FIREARMS	H. HOUSE-HOLD GOODS
	STOLEN	\$	\$	\$	\$	\$	\$	\$	\$
	RECOVERED	\$	\$	\$	\$	\$	\$	\$	\$
	26. PROPERTY	I. CONSUMABLES	J. LIVESTOCK	K. DRUGS	L. MARINE ITEMS	M. CONSTRUCTION ITEMS	N. LAWN AND GARDEN	O. SPORTING GOODS	P. MISC BICYCLE
	STOLEN	\$	\$	\$	\$	\$	\$	\$	\$
	RECOVERED	\$	\$	\$	\$	\$	\$	\$	\$

27. PROPERTY RECOVERED: LOCALLY _____ OTHER JURISDICTION _____ (INSERT O OR L)

PROPERTY ITEMIZATION	PROPERTY STOLEN/RECOVERED ITEMIZATION, USE THE FOLLOWING FORMAT				
	28. QUANTITY	29. ARTICLE NAME	30. BRAND NAME	31. SERIAL NUMBER	32. CODE
					S R <input type="checkbox"/> <input type="checkbox"/>
					S R <input type="checkbox"/> <input type="checkbox"/>
					S R <input type="checkbox"/> <input type="checkbox"/>
					S R <input type="checkbox"/> <input type="checkbox"/>

33. PROPERTY DAMAGE AMOUNT \$ _____

34. INSURANCE COMPANY _____

35. OFFICER ASSAULTED Y N

36. ARSON Y N

37. STRUCTURE CODE _____

38. DAMAGE \$ _____

47. CIB
 NCIC
 OTHER BROADCAST

ENTERED	<input type="checkbox"/>	CANCELLED	<input type="checkbox"/>
	<input type="checkbox"/>		<input type="checkbox"/>
	<input type="checkbox"/>		<input type="checkbox"/>

48. TOTAL AMOUNT PROPERTY STOLEN \$ _____

49. TOTAL AMOUNT PROPERTY RECOVERED \$ _____

50. IS REPORT CONTINUED? YES NO

51. CAUTION INDICATORS, ATLS ETC.

52. DATA PROCESS INFORMATION:

COMPUTER ENTERED DATE 3.8.99
 MICROFILM INDEXED INITIAL JS

53. FILE APPROVAL

IS CASE CLASSIFICATION CORRECT?
 IF N HAS CORRECTION BEEN MADE? N N

BY [Signature] DATE 03/08/99

INCIDENT CARD

INCIDENT
 11. CS 599-00242
 5. INCIDENT LOCATION
 66 Albert Dr. Trailer Court
 7. D.O.B. [REDACTED] 46515 [REDACTED]
 8. ADDRESS [REDACTED]
 9. TX HOME [REDACTED]
 10. TX-BUSINESS [REDACTED]
 12. DETAILS
 Compl. states that he observed that ever since this accident he no longer see the Chev Blazer that used to be parked between lot 40-41 in the trailer court of [REDACTED] W Albert Dr. It is unk who owned this vehicle. It was whi/sil/gry 2dr with red chev symbol on rear of vehicle.

022299 035
 022299 1135

18. ASSIGNED
 MATSO CS 9:29
 Bushman 441
 19. REC. BY 923
 20. DIS. BY 923
 22. TYPE OF REPORT
 1. INCIDENT
 2. ACCIDENT
 3. CITATION
 4. NONE
 21. HOW REC'D.
 1. 911
 2. POLICE RADIO
 3. PHONE
 4. TTY
 5. IN PERSON
 6. ON VIEW
 7. OFF. OFF DUTY
 8. C.B. RADIO
 9. OTHER
 23. STATUS
 1. UNFOUNDED
 2. PNL
 3. OTHER
 4. CLEARED
 5. EXCEPT CLEARED
 24. DATE CLEARED 03 08 99
 25. OFFENSE TYPE
 1. ADULT
 2. JUVENILE
 3. UNKNOWN

14. REC'D	15. DISP	16. 10-23	17. 10-24
13. DAY			
SUN 1	THU 5		
MON 2	FRI 6		
TUE 3	SAT 7		
WED 4			

39. (CODE S-SUSPECT W-WITNESS V-VICTIM O-OTHER)

CODE	40. NAME-LAST	FIRST	MI	41. D.O.B.	42. ADDRESS	43. TELEPHONE
0	Drexler Thomas A.	11859		[REDACTED]	[REDACTED] E. Albert #58 Mtwc.	
0	Nordin Jean A.	91960		[REDACTED]	[REDACTED] E Albert #40 Mtwc	

Compl. did state that he thought a Nordon lived at lot [REDACTED] and was a semi driver for Chizek trucking. JL
 02/23/99 1809hrs Contact made with Jean Nordin at trailer [REDACTED]. She advised the vehicle I was describing belongs to Thomas Drexler and pointed to trailer [REDACTED]. Contact attempted at [REDACTED], lights on, their regularly used Ford Explorer was not parked in front. Followup required.
 M.J. Bushman
 02/24/99 1434hrs Contact made with Thomas Drexler at [REDACTED] E. Albert Mtwc. He stated he does own the vehicle in question and it was parked between trailers 40 and 41 until mid January. He then moved to Myron Arhens residence [REDACTED] W. Marshal.
 Vehicle observed in the driveway [REDACTED] W. Marshal. There was damage around the Rt. headlamp but the grille was in place and appeared to be original. There was no other damage and it had very large mud tires as well as raised higher than factory deliver height. This is not the hit and run vehicle, close out. M.J. Bushman
 Registration KWW111 88 Chev Blazer (old Style) MJS

45. IF COMPLAINANT DIFFERENT THEN CALLER, ENTER NAME, ADDRESS, D.O.B., TELEPHONE.

46. IF CODE O (OTHER) IS USED IN FIELD #39, EXPLAIN.

INCIDENT REPORT: NOTE: IF SECTION 22 ABOVE HAS NUMBER 4 CHECKED, DO NOT GO BEYOND THIS LINE WITHOUT RECORDS SECTION BEING ADVISED, OR NO RECORD ENTRIES WILL BE MADE BELOW THIS LINE.

PROPERTY VALUE	26. PROPERTY	A. CURRENCY	B. JEWELRY	C. FURS CLOTHING	D. VEHICLE (LOCAL)	E. OFFICE EQUIPMENT	F. RADIO, TV CAMERAS	G. FIREARMS	H. HOUSE-HOLD GOODS
	STOLEN	\$	\$	\$	\$	\$	\$	\$	\$
	RECOVERED	\$	\$	\$	\$	\$	\$	\$	\$
	26. PROPERTY	I. CONSUM-ABLES	J. LIVESTOCK	K. DRUGS	L. MARINE ITEMS	M. CONSTRUC-TION ITEMS	N. LAWN AND GARDEN	O. SPORTING GOODS	P. MISC BICYCLE
STOLEN	\$	\$	\$	\$	\$	\$	\$	\$	
RECOVERED	\$	\$	\$	\$	\$	\$	\$	\$	

27. PROPERTY RECOVERED: LOCALLY _____ OTHER JURISDICTION _____ (INSERT O OR L)

PROPERTY ITEMIZATION	PROPERTY STOLEN/RECOVERED ITEMIZATION, USE THE FOLLOWING FORMAT				
	28. QUANTITY	29. ARTICLE NAME	30. BRAND NAME	31. SERIAL NUMBER	32. CODE
					S R <input type="checkbox"/> <input type="checkbox"/>
					S R <input type="checkbox"/> <input type="checkbox"/>
					S R <input type="checkbox"/> <input type="checkbox"/>
					S R <input type="checkbox"/> <input type="checkbox"/>

33. PROPERTY DAMAGE AMOUNT \$ _____

34. INSURANCE COMPANY _____

35. OFFICER ASSAULTED Y N

36. ARSON Y N

37. STRUCTURE CODE _____

38. DAMAGE \$ _____

47. CIB ENTERED CANCELLED
 NCIC ENTERED CANCELLED
 OTHER BROADCAST ENTERED CANCELLED

48. TOTAL AMOUNT PROPERTY STOLEN \$ _____

49. TOTAL AMOUNT PROPERTY RECOVERED \$ _____

50. IS REPORT CONTINUED? YES NO

51. CAUTION INDICATORS, ATLS ETC.

52. DATA PROCESS INFORMATION:

COMPUTER ENTERED DATE 131899
 MICROFILM INDEXED INITIAL AS

53. FILE APPROVAL

IS CASE CLASSIFICATION CORRECT? N
 IF N HAS CORRECTION BEEN MADE? N

BY [Signature] DATE 131899

1. CASE # 2. CLASSIFICATION 3. CENSUS

S99 No 01529

6-3101

MANITOWOC COUNTY SHERIFF INCIDENT CARD

4. INCIDENT CS/ S99-00242

5. INCIDENT LOCATION Green Bay

6. NAME - LAST - FIRST - MI Anonymous 7. D.O.B.

8. ADDRESS 9. TX-HOME 10. TX-BUSINESS

11. CITY STATE ZIP

12. DETAILS The caller and her boyfriend were driving in Green Bay and saw a Tan/Brown and rusty p/u get off I-43 near Esttown Mall. Driver appeared to be lost. He gassed and left. Registration XK 6497 Vehicle has grille damage, passenger side.

1740AMS 2/22/99

18. ASSIGNED Bushman 4/4/1 929

19. REC. BY MJB 20. DIS. BY MJB 22. TYPE OF REPORT INCIDENT

21. HOW REC'D. 1. 911 2. POLICE RADIO 3. PHONE 4. TTY 5. IN PERSON 6. ON VIEW 7. OFF. OFF DUTY 8. C.B. RADIO 9. OTHER 23. STATUS 1. UNFOUNDED 2. PNL 3. OTHER 4. CLEARED 5. EXCEPT CLEARED

24. DATE CLEARED 03/08/99 25. OFFENSE TYPE 1. ADULT NA 2. JUVENILE 3. UNKNOWN

14. REC'D 15. DISP 16. 10-23 17. 10-24 13. DAY SUN 1 THU 5 MON 2 FRI 6 TUE 3 SAT 7 WED 4

39. (CODE S-SUSPECT W-WITNESS V-VICTIM O-OTHER)

Table with 4 columns: CODE, 40. NAME-LAST FIRST MI, 41. D.O.B., 42. ADDRESS, 43. TELEPHONE. Row 1: O, Lyman Lee Echola, 176254, [redacted] Oss Rd, Crystal Falls Mi.

Vehicle plate comes back on a 1980 Chev truck, we are targeting Chev. trucks from 1985-1988. Caller thought the vehicle was around a 1979, in any event it would be too old. Close out M.J. Bushman

S99 No 01529

45. IF COMPLAINANT DIFFERENT THEN CALLER, ENTER NAME, ADDRESS, D.O.B., TELEPHONE.

46. IF CODE O (OTHER) IS USED IN FIELD #39, EXPLAIN.

INCIDENT REPORT: NOTE: IF SECTION 22 ABOVE HAS NUMBER 4 CHECKED, DO NOT GO BEYOND THIS LINE WITHOUT RECORDS SECTION BEING ADVISED, OR NO RECORD ENTRIES WILL BE MADE BELOW THIS LINE.

PROPERTY VALUE	26. PROPERTY	A. CURRENCY	B. JEWELRY	C. FURS CLOTHING	D. VEHICLE (LOCAL)	E. OFFICE EQUIPMENT	F. RADIO, TV CAMERAS	G. FIREARMS	H. HOUSE-HOLD GOODS
	STOLEN	\$	\$	\$	\$	\$	\$	\$	\$
	RECOVERED	\$	\$	\$	\$	\$	\$	\$	\$
	26. PROPERTY	I. CONSUMABLES	J. LIVESTOCK	K. DRUGS	L. MARINE ITEMS	M. CONSTRUCTION ITEMS	N. LAWN AND GARDEN	O. SPORTING GOODS	P. MISC BICYCLE
	STOLEN	\$	\$	\$	\$	\$	\$	\$	\$
	RECOVERED	\$	\$	\$	\$	\$	\$	\$	\$

27. PROPERTY RECOVERED: LOCALLY _____ OTHER JURISDICTION _____ (INSERT O OR L)

PROPERTY ITEMIZATION	PROPERTY STOLEN/RECOVERED ITEMIZATION, USE THE FOLLOWING FORMAT				
	28. QUANTITY	29. ARTICLE NAME	30. BRAND NAME	31. SERIAL NUMBER	32. CODE
					S R <input type="checkbox"/> <input type="checkbox"/>
					S R <input type="checkbox"/> <input type="checkbox"/>
					S R <input type="checkbox"/> <input type="checkbox"/>
					S R <input type="checkbox"/> <input type="checkbox"/>
					S R <input type="checkbox"/> <input type="checkbox"/>

33. PROPERTY DAMAGE AMOUNT \$ _____ 34. INSURANCE COMPANY _____

35. OFFICER ASSAULTED Y N 36. ARSON Y N 37. STRUCTURE CODE _____ 38. DAMAGE \$ _____

47. CIB NCIC OTHER BROADCAST	ENTERED	CANCELLED	48. TOTAL AMOUNT PROPERTY STOLEN \$ _____
	<input type="checkbox"/>	<input type="checkbox"/>	
	<input type="checkbox"/>	<input type="checkbox"/>	
			49. TOTAL AMOUNT PROPERTY RECOVERED \$ _____

50. IS REPORT CONTINUED? YES NO

51. CAUTION INDICATORS, ATLS ETC.

52. DATA PROCESS INFORMATION:

COMPUTER ENTERED DATE 131899
MICROFILM INDEXED INITIAL DS

53. FILE APPROVAL

IS CASE CLASSIFICATION CORRECT? N
IF N HAS CORRECTION BEEN MADE? N

BY [Signature] DATE 131899

4. INCIDENT
CS-599-00242

5. INCIDENT LOCATION

6. NAME- LAST - FIRST - MI
CASO (205)

7. D.O.B.

8. ADDRESS

9. TX-HOME

10. TX-BUSINESS

11. CITY STATE ZIP

12. DETAILS
[REDACTED] called stating she saw a veh. w/ left front grill damage. 2 tone brown GMC RP# TRC 210. See worksheet for further

5281 1825
02299 1825

INCIDENT CARD

18. ASSIGNED
MATSU-CO 929
BUSHMAN HHI

19. REC. BY
923

20. DIS. BY

21. HOW REC'D.
1. 911
2. POLICE RADIO
3. PHONE
4. TTY
5. IN PERSON
6. ON VIEW
7. OFF. OFF DUTY
8. C.B. RADIO
9. OTHER

22. TYPE OF REPORT
1. INCIDENT
2. ACCIDENT
3. CITATION
4. NONE

23. STATUS
1. UNFOUNDED
2. PNL
3. OTHER
4. CLEARED
5. EXCEPT CLEARED

24. DATE CLEARED
R38 199

25. OFFENSE TYPE
1. ADULT NA
2. JUVENILE
3. UNKNOWN

13. DAY

14. REC'D.	15. DISP.	16. 10-23	17. 10-24
SUN 1	THU 5		
MON 2	FRI 6		
TUE 3	SAT 7		
WED 4			

39. (CODE S-SUSPECT W-WITNESS V-VICTIM O-OTHER)

CODE	40. NAME- LAST	FIRST	MI	41. D.O.B.	42. ADDRESS	43. TELEPHONE
0	Barton Dufrane Constrtuction Inc.				Central Ave. Fond du lac	

02/23/99 I, Lt. Bushman made contact by phone with the complainant. She advised the older truck was observed at a bowling alley in Fond du lac. She could not recall many details, but did note it had two rectangular headlamps on each side of the grille which was damaged on the drivers side. Registration comes back to an 87 GMC. This is not our suspect vehicle close out. M.J. Bushman

MJB

CASE #
S99 No 01533

45. IF COMPLAINANT DIFFERENT THEN CALLER, ENTER NAME, ADDRESS, D.O.B., TELEPHONE.

46. IF CODE O (OTHER) IS USED IN FIELD #39, EXPLAIN.

INCIDENT REPORT: NOTE: IF SECTION 22 ABOVE HAS NUMBER 4 CHECKED, DO NOT GO BEYOND THIS LINE WITHOUT RECORDS SECTION BEING ADVISED, OR NO RECORD ENTRIES WILL BE MADE BELOW THIS LINE.

PROPERTY VALUE	26. PROPERTY	A. CURRENCY	B. JEWELRY	C. FURS CLOTHING	D. VEHICLE (LOCAL)	E. OFFICE EQUIPMENT	F. RADIO, TV CAMERAS	G. FIREARMS	H. HOUSE-HOLD GOODS
	STOLEN	\$	\$	\$	\$	\$	\$	\$	\$
	RECOVERED	\$	\$	\$	\$	\$	\$	\$	\$
	26. PROPERTY	I. CONSUM-ABLES	J. LIVESTOCK	K. DRUGS	L. MARINE ITEMS	M. CONSTRUCTION ITEMS	N. LAWN AND GARDEN	O. SPORTING GOODS	P. MISC BICYCLE
	STOLEN	\$	\$	\$	\$	\$	\$	\$	\$
	RECOVERED	\$	\$	\$	\$	\$	\$	\$	\$

27. PROPERTY RECOVERED: LOCALLY _____ OTHER JURISDICTION _____ (INSERT O OR L)

PROPERTY ITEMIZATION	PROPERTY STOLEN/RECOVERED ITEMIZATION, USE THE FOLLOWING FORMAT				
	28. QUANTITY	29. ARTICLE NAME	30. BRAND NAME	31. SERIAL NUMBER	32. CODE
					S R <input type="checkbox"/> <input type="checkbox"/>
					S R <input type="checkbox"/> <input type="checkbox"/>
					S R <input type="checkbox"/> <input type="checkbox"/>
					S R <input type="checkbox"/> <input type="checkbox"/>

33. PROPERTY DAMAGE AMOUNT \$ _____

34. INSURANCE COMPANY _____

35. OFFICER ASSAULTED Y N

36. ARSON Y N

37. STRUCTURE CODE _____ 38. DAMAGE \$ _____

47. CIB ENTERED CANCELLED
 NCIC
 OTHER BROADCAST

48. TOTAL AMOUNT PROPERTY STOLEN \$ _____

49. TOTAL AMOUNT PROPERTY RECOVERED \$ _____

50. IS REPORT CONTINUED? YES NO

51. CAUTION INDICATORS, ATLS ETC.

52. DATA PROCESS INFORMATION:

COMPUTER ENTERED DATE 13/8/99
 MICROFILM INDEXED INITIAL AS

53. FILE APPROVAL

IS CASE CLASSIFICATION CORRECT? N
 IF N HAS CORRECTION BEEN MADE? N

BY [Signature] DATE 03/08/99

1. CASE # S99 No 01174 2. CLASSIFICATION 5.71.8 3. CENSUS 7.0000

4. INCIDENT: EK Veh / S99-00242

5. INCIDENT LOCATION: SBSO INTERND

6. NAME - LAST-FIRST-MI: SBSO (156) 7. D.O.B.

8. ADDRESS: [REDACTED] 9. TX-HOME

10. TX-BUSINESS

12. DETAILS: Possibly veh involved in FATAL HR - S99-00242

66620
1008 0709
1008

MANITOWOC COUNTY SHERIFF INCIDENT CARD

18. ASSIGNED: GLAESER 4117

19. REC. BY: [Signature] 20. DIS. BY: [Signature]

21. HOW REC'D:
 1. 911
 2. POLICE RADIO
 3. PHONE
 4. TTY
 5. IN PERSON
 6. ON VIEW
 7. OFF. OFF DUTY
 8. C.B. RADIO
 9. OTHER
 21A. M.O.

22. TYPE OF REPORT:
 1. INCIDENT
 2. ACCIDENT
 3. CITATION
 4. NONE

23. STATUS:
 1. UNFOUNDED
 2. PENDING
 3. OTHER
 4. CLEARED
 5. EXCEPT CLEARED

24. DATE CLEARED: 03 08 1999

25. OFFENSE TYPE:
 1. ADULT NA
 2. JUVENILE
 3. UNKNOWN

AC
1117

39. (CODE S-SUSPECT W-WITNESS V-VICTIM O-OTHER)				42. ADDRESS		43. TELEPHONE
CODE	40. NAME-LAST	FIRST	MI	41. D.O.B.		
O	WARNER	170111	CHERYL	A	[REDACTED] CTH C, Glenbeulah 53023	

02/09/99 @ 1015 Hrs.: I, Deputy E. Glaeser, made telephone contact with SBSO Deputy #118 after receiving information from Dispatch that their dept. recovered a vehicle which was apparently abandoned on CTH T near Greenbush that had possibilities of matching our hit and run suspect vehicle. In speaking with Deputy #118, he indicated the vehicle was a 1984 Chevy pickup with right front damage, consistent to our hit and run. In speaking with Deputy #118 on the phone, the information that he relayed to me seemed to indicate the vehicle had a strong possibility that it may match our suspect vehicle description. The Shift Commander was notified at this time, and he authorized me to travel to Sheboygan Co. to observe the vehicle.

Upon making contact with a SBSO officer and observing the vehicle, it should be noted the vehicle did not match our hit and run parameters as there was a marked difference in the grill style. The damage which was incurred on the vehicle was consistent with the one we are looking for, but the grill model does not match.

The RP on the vehicle was BH51214, for a 1984 Chevy pickup truck listed to CHERYL WARNER.

No further action taken at this time. EJGlaeser *EJG* /bjc

PP 8000

A

S99 No 01174

1. CASE # S99 No 01178 | 2. CLASSIFICATION 6310.11 | 3. CENSUS 14002

MANITOWOC COUNTY SHERIFF
INCIDENT CARD

4. INCIDENT NUMBER CS/00242
5. INCIDENT LOCATION CTH CR

6. NAME LAST FIRST MI [REDACTED] | 7. D.O.B. [REDACTED]

8. ADDRESS [REDACTED] | 9. TX-HOME [REDACTED]

11. CITY [REDACTED] STATE [REDACTED] ZIP [REDACTED] | 10. TX-BUSINESS [REDACTED]

12. DETAILS
INFORMATION REGARDING H+R ON
CTH CR.

14. REC'D 2-9-99
15. DISP 1416
16. 10-23 1430
17. 10-24 1600

18. ASSIGNED JOST | 4149
929

19. REC. BY 932 | 20. DIS. BY 932
21. HOW REC'D.
1. 911
2. POLICE RADIO
3. PHONE
4. TTY
5. IN PERSON
6. ON VIEW
7. OFF. OFF DUTY
8. C.B. RADIO
9. OTHER
21A. M.O.
22. TYPE OF REPORT
1. INCIDENT
2. ACCIDENT
3. CITATION
4. NONE
23. STATUS
1. UNFOUNDED
2. PNL
3. OTHER
4. CLEARED
5. EXCEPT CLEARED
24. DATE CLEARED 03/08/99
25. OFFENSE TYPE
1. ADULT NA
2. JUVENILE
3. UNKNOWN

39. (CODE S-SUSPECT W-WITNESS V-VICTIM O-OTHER)							
CODE	40. NAME-LAST	FIRST	MI	41. D.O.B.	42. ADDRESS	43. TELEPHONE	
0	[REDACTED]	144387	[REDACTED]	[REDACTED]	[REDACTED]	[REDACTED]	
0	[REDACTED]	331100	[REDACTED]	[REDACTED]	[REDACTED]	[REDACTED]	
0	Reichwaldt	156273	Philip	C.	[REDACTED] CTH C	[REDACTED]	

02-09-99 I, Deputy Jost, received information from [REDACTED] and a second anonymous subject that [REDACTED] was telling them and other kids at school about Philip possibly being involved in the H and R accident. I interviewed [REDACTED] the and the anonymous complainant. Due to Philip being investigated several times already and no new information available this report can be closed. See Incident number S99-00242 for further information. *JMJ*

JUVENILE INFO REDACTED

AP 17 83

7110 FN 880

45. IF COMPLAINANT DIFFERENT THEN CALLER, ENTER NAME, ADDRESS, D.O.B., TELEPHONE.

46. IF CODE O (OTHER) IS USED IN FIELD #39, EXPLAIN.

INCIDENT REPORT: NOTE: IF SECTION 22 ABOVE HAS NUMBER 4 CHECKED, DO NOT GO BEYOND THIS LINE WITHOUT RECORDS SECTION BEING ADVISED, OR NO RECORD ENTRIES WILL BE MADE BELOW THIS LINE.

PROPERTY VALUE	26. PROPERTY	A. CURRENCY	B. JEWELRY	C. FURS CLOTHING	D. VEHICLE (LOCAL)	E. OFFICE EQUIPMENT	F. RADIO, TV CAMERAS	G. FIREARMS	H. HOUSE-HOLD GOODS
	STOLEN	\$	\$	\$	\$	\$	\$	\$	\$
	RECOVERED	\$	\$	\$	\$	\$	\$	\$	\$
	26. PROPERTY	I. CONSUMABLES	J. LIVESTOCK	K. DRUGS	L. MARINE ITEMS	M. CONSTRUCTION ITEMS	N. LAWN AND GARDEN	O. SPORTING GOODS	P. MISC BICYCLE
	STOLEN	\$	\$	\$	\$	\$	\$	\$	\$
	RECOVERED	\$	\$	\$	\$	\$	\$	\$	\$

27. PROPERTY RECOVERED: LOCALLY _____ OTHER JURISDICTION _____ (INSERT O OR L)

PROPERTY ITEMIZATION	PROPERTY STOLEN/RECOVERED ITEMIZATION, USE THE FOLLOWING FORMAT			
	28. QUANTITY	29. ARTICLE NAME	30. BRAND NAME	31. SERIAL NUMBER
				32. CODE S <input type="checkbox"/> R <input type="checkbox"/>
				S <input type="checkbox"/> R <input type="checkbox"/>
				S <input type="checkbox"/> R <input type="checkbox"/>
				S <input type="checkbox"/> R <input type="checkbox"/>
				S <input type="checkbox"/> R <input type="checkbox"/>
				S <input type="checkbox"/> R <input type="checkbox"/>

33. PROPERTY DAMAGE AMOUNT \$ _____

34. INSURANCE COMPANY _____

35. OFFICER ASSAULTED Y N

36. ARSON Y N

37. STRUCTURE CODE _____

38. DAMAGE \$ _____

47. CIB ENTERED CANCELLED
 NCIC
 OTHER BROADCAST

48. TOTAL AMOUNT PROPERTY STOLEN \$ _____

49. TOTAL AMOUNT PROPERTY RECOVERED \$ _____

50. IS REPORT CONTINUED? YES NO

51. CAUTION INDICATORS, ATLS ETC.

52. DATA PROCESS INFORMATION:

COMPUTER ENTERED DATE 9/8/99
 MICROFILM INDEXED INITIAL AS

53. FILE APPROVAL

IS CASE CLASSIFICATION CORRECT? N
 IF N HAS CORRECTION BEEN MADE? N

BY RP DATE 03/07/99

1. CASE # S99 No 01202
 2. CLASSIFICATION 6,3|0,1| 5,2|0,0,0
 3. CENSUS

INCIDENT # 03/899-00242

INCIDENT LOCATION

6. NAME - LAST - FIRST - MI

7. D.O.B.

Anonymous

ADDRESS

9. TX-HOME

11. CITY

STATE ZIP

10. TX-BUSINESS

12. DETAILS
See Attached.

02/10/99 1630

MANITOWOC COUNTY SHERIFF
INCIDENT CARD

18. ASSIGNED
 MTSO CS 9/2/99
 M.J. Bushman 4/1/11

19. REC. BY 935
 20. DIS. BY
 21. HOW REC'D.
 1. 911
 2. POLICE RADIO
 3. PHONE
 4. TTY
 5. IN PERSON
 6. ON VIEW
 7. OFF. OFF DUTY
 8. C.B. RADIO
 9. OTHER
 21A.M.O.
 22. TYPE OF REPORT
 1. INCIDENT
 2. ACCIDENT
 3. CITATION
 4. NONE
 23. STATUS
 1. UNFOUNDED
 2. PNL
 3. OTHER
 4. CLEARED
 5. EXCEPT CLEARED
 24. DATE CLEARED 03 PD 199
 25. OFFENSE TYPE
 1. ADULT NA
 2. JUVENILE
 3. UNKNOWN

14. REC'D
 15. DISP
 16. 10-23
 17. 10-24
 13. DAY
 SUN 1 THU 5
 MON 2 FRI 6
 TUE 3 SAT 7
 WED 4

39. (CODE S-SUSPECT W-WITNESS V-VICTIM O-OTHER)	40. NAME-LAST	FIRST	MI	41. D.O.B.	42. ADDRESS	43. TELEPHONE
O	Knapp, Kenneth D.	418			N.Packer Dr., Whitelaw	

02/17/99 Attempted contact at [redacted] Packer Dr. however Kenneth was at work in Manitowoc at PDQ. Noting it was after 1600hrs Off. inquired as to where Knapp could be found now. IT was learned he was at his girlfriend's house [redacted] E.River Two Rivers, Missy Pautz. Contact made by phone and arrangements made with T.R.P.D. Off. Keery to swing by the residence and check the vehicle. Suspect vehicle is an 80 Chev van with a large blk grill design not consistent with the photo's passed on to T.R.P.D. There is not other sheet metal damage. This is not the suspect vehicle, close out. M.J. Bushman

PP 82 80

PP 81 80

S99 No 01202

45. IF COMPLAINANT DIFFERENT THEN CALLER, ENTER NAME, ADDRESS, D.O.B., TELEPHONE.

46. IF CODE O (OTHER) IS USED IN FIELD #39, EXPLAIN.

INCIDENT REPORT: NOTE: IF SECTION 22 ABOVE HAS NUMBER 4 CHECKED, DO NOT GO BEYOND THIS LINE WITHOUT RECORDS SECTION BEING ADVISED, OR NO RECORD ENTRIES WILL BE MADE BELOW THIS LINE.

PROPERTY VALUE	26. PROPERTY	A. CURRENCY	B. JEWELRY	C. FURS CLOTHING	D. VEHICLE (LOCAL)	E. OFFICE EQUIPMENT	F. RADIO, TV CAMERAS	G. FIREARMS	H. HOUSEHOLD GOODS
	STOLEN	\$	\$	\$	\$	\$	\$	\$	\$
	RECOVERED	\$	\$	\$	\$	\$	\$	\$	\$
	26. PROPERTY	I. CONSUMABLES	J. LIVESTOCK	K. DRUGS	L. MARINE ITEMS	M. CONSTRUCTION ITEMS	N. LAWN AND GARDEN	O. SPORTING GOODS	P. MISC BICYCLE
	STOLEN	\$	\$	\$	\$	\$	\$	\$	\$
	RECOVERED	\$	\$	\$	\$	\$	\$	\$	\$

27. PROPERTY RECOVERED: LOCALLY _____ OTHER JURISDICTION _____ (INSERT O OR L)

PROPERTY ITEMIZATION	PROPERTY STOLEN/RECOVERED ITEMIZATION, USE THE FOLLOWING FORMAT				
	28. QUANTITY	29. ARTICLE NAME	30. BRAND NAME	31. SERIAL NUMBER	32. CODE
					S R <input type="checkbox"/> <input type="checkbox"/>
					S R <input type="checkbox"/> <input type="checkbox"/>
					S R <input type="checkbox"/> <input type="checkbox"/>
					S R <input type="checkbox"/> <input type="checkbox"/>
					S R <input type="checkbox"/> <input type="checkbox"/>

33. PROPERTY DAMAGE AMOUNT \$ _____ 34. INSURANCE COMPANY _____

35. OFFICER ASSAULTED Y N 36. ARSON Y N 37. STRUCTURE CODE _____ 38. DAMAGE \$ _____

47. CIB ENTERED CANCELLED
 NCIC
 OTHER BROADCAST

48. TOTAL AMOUNT PROPERTY STOLEN \$ _____
 49. TOTAL AMOUNT PROPERTY RECOVERED \$ _____

50. IS REPORT CONTINUED? YES NO

51. CAUTION INDICATORS, ATLS ETC.

52. DATA PROCESS INFORMATION:

COMPUTER ENTERED DATE 10/31/99
 MICROFILM INDEXED INITIAL bji

IS CASE CLASSIFICATION CORRECT? Y N
 IF N HAS CORRECTION BEEN MADE? Y N

53. FILE APPROVAL

BY [Signature] DATE 10/28/99

1. CASE # S99 No 01209 2. CLASSIFICATION 63011 3. CENSUS 52000

4. INCIDENT CS/S99-00242

5. INCIDENT LOCATION Rapids Rd

6. NAME - FIRST - MI Hnon 7. D.O.B.

8. ADDRESS 9. TX-HOME

11. CITY STATE ZIP 10. TX-BUSINESS

12. DETAILS
 DK colored Chev grill out
 on passenger side
 Veh seen in Rapids area
 earlier today. RA# J42500

1953 2-10-99

MANITOWOC COUNTY SHERIFF
INCIDENT CARD

18. ASSIGNED
 M750 929
 Glaeser HLT

19. REC. BY 926 20. DIS. BY

21. HOW REC'D.
 1. 911
 2. POLICE RADIO
 3. PHONE
 4. TTY
 5. IN PERSON
 6. ON VIEW
 7. OFF. OFF DUTY
 8. C.B. RADIO
 9. OTHER

22. TYPE OF REPORT
 1. INCIDENT
 2. ACCIDENT
 3. CITATION
 4. NONE

23. STATUS
 1. UNFOUNDED
 2. PNL
 3. OTHER
 4. CLEARED
 5. EXCEPT CLEARED

24. DATE CLEARED 02/16/99

25. OFFENSE TYPE
 1. ADULT NA
 2. JUVENILE
 3. UNKNOWN

13. DAY
 SUN 1 THU 5
 MON 2 FRI 6
 TUE 3 SAT 7
 WED 4

21A. M.O.

39. (CODE S-SUSPECT W-WITNESS V-VICTIM O-OTHER)	40. NAME-LAST	FIRST	MI	41. D.O.B.	42. ADDRESS	43. TELEPHONE
0	OLSON	ROGER	J		Hamann Rd, Manitowoc	

02/15/99 @ 1110 Hrs.: I, Deputy E. Glaeser, followed up on this Crime Stopper report. The vehicle reported with damage was located at Hamann Rd, Manitowoc. I observed it was a gray 1986 GMC Sierra truck. This vehicle is not a match with the hit and run parameters from S99-00242. The truck in question does have right front damage, but the grill is inconsistent with our suspect vehicle. The vehicle, at this location, is registered to ROGER OLSON.

This vehicle can be eliminated. No further action taken. EJGlaeser *EJG* /bjc

45. IF COMPLAINANT DIFFERENT THEN CALLER, ENTER NAME, ADDRESS, D.O.B., TELEPHONE.

46. IF CODE O (OTHER) IS USED IN FIELD #39, EXPLAIN.

INCIDENT REPORT: NOTE: IF SECTION 22 ABOVE HAS NUMBER 4 CHECKED, DO NOT GO BEYOND THIS LINE WITHOUT RECORDS SECTION BEING ADVISED, OR NO RECORD ENTRIES WILL BE MADE BELOW THIS LINE.

P R O P E R T Y V A L U E	26. PROPERTY	A. CURRENCY	B. JEWELRY	C. FURS CLOTHING	D. VEHICLE (LOCAL)	E. OFFICE EQUIPMENT	F. RADIO, TV CAMERAS	G. FIREARMS	H. HOUSE-HOLD GOODS
	STOLEN	\$	\$	\$	\$	\$	\$	\$	\$
	RECOVERED	\$	\$	\$	\$	\$	\$	\$	\$
	26. PROPERTY	I. CONSUMABLES	J. LIVESTOCK	K. DRUGS	L. MARINE ITEMS	M. CONSTRUCTION ITEMS	N. LAWN AND GARDEN	O. SPORTING GOODS	P. MISC BICYCLE
STOLEN	\$	\$	\$	\$	\$	\$	\$	\$	
RECOVERED	\$	\$	\$	\$	\$	\$	\$	\$	

27. PROPERTY RECOVERED: LOCALLY ____ OTHER JURISDICTION ____ (INSERT O OR L)

P R O P E R T Y I T E M I Z A T I O N	PROPERTY STOLEN/RECOVERED ITEMIZATION, USE THE FOLLOWING FORMAT				
	28. QUANTITY	29. ARTICLE NAME	30. BRAND NAME	31. SERIAL NUMBER	32. CODE
					S R <input type="checkbox"/> <input type="checkbox"/>
					S R <input type="checkbox"/> <input type="checkbox"/>
					S R <input type="checkbox"/> <input type="checkbox"/>
					S R <input type="checkbox"/> <input type="checkbox"/>

33. PROPERTY DAMAGE AMOUNT \$ _____

34. INSURANCE COMPANY _____

35. OFFICER ASSAULTED Y N

36. ARSON Y N

37. STRUCTURE CODE _____

38. DAMAGE \$ _____

47. CIB ENTERED CANCELLED
 NCIC
 OTHER BROADCAST

48. TOTAL AMOUNT PROPERTY STOLEN \$ _____

49. TOTAL AMOUNT PROPERTY RECOVERED \$ _____

50. IS REPORT CONTINUED? YES NO

51. CAUTION INDICATORS, ATLS ETC.

52. DATA PROCESS INFORMATION:

COMPUTER ENTERED DATE 12/18/99

MICROFILM INDEXED INITIAL KS

IS CASE CLASSIFICATION CORRECT? N
 IF N HAS CORRECTION BEEN MADE? N

53. FILE APPROVAL

BY QR

DATE 02/16/99

1. CASE # S99 No 01208 2. CLASSIFICATION 6301 3. CENSUS 52000

4. INCIDENT CS/S99-00242

5. INCIDENT LOCATION [redacted] Menasha Ave

6. NAME - LAST - FIRST - MI Anon 7. D.O.B.

8. ADDRESS 9. TX-HOME

11. CITY STATE ZIP 10. TX-BUSINESS

13. DETAILS Reports RP# BA 73-950 a grey Silverado chev with front grill out parked at above loc. [redacted] Menasha

1950 2-10-99

MANITOWOC COUNTY SHERIFF INCIDENT CARD

18. ASSIGNED MTSO Jost 929 HHP

19. REC. BY C26 20. DIS. BY 22. TYPE OF REPORT 1. INCIDENT 2. ACCIDENT 3. CITATION 4. NONE

21. HOW REC'D. 1. 911 2. POLICE RADIO 3. PHONE 4. TTY 5. IN PERSON 6. ON VIEW 7. OFF. OFF DUTY 8. C.B. RADIO 9. OTHER 23. STATUS 1. UNFOUNDED 2. PNL 3. OTHER 4. CLEARED 5. EXCEPT CLEARED

24. DATE CLEARED 10/31/99 25. OFFENSE TYPE 1. ADULT 2. JUVENILE 3. UNKNOWN

14. REC'D 15. DISP 16. 10-23 17. 10-24 13. DAY SUN 1 THU 5 MON 2 FRI 6 TUE 3 SAT 7 WED 4

Table with 5 columns: CODE, 40. NAME-LAST, FIRST, MI, 41. D.O.B., 42. ADDRESS, 43. TELEPHONE. Row 1: [redacted]

02-19-99 I, Deputy Jost, checked this vehicle against our master file. This vehicle has already been inspected and no follow-up needs to be done. This info. added to S99-00242 [signature]

PP 80 EB

[Handwritten mark]

100-100000
 100-100000
 100-100000
 100-100000

45. IF COMPLAINANT DIFFERENT THEN CALLER, ENTER NAME, ADDRESS, D.O.B., TELEPHONE.

46. IF CODE O (OTHER) IS USED IN FIELD #39, EXPLAIN.

INCIDENT REPORT: NOTE: IF SECTION 22 ABOVE HAS NUMBER 4 CHECKED, DO NOT GO BEYOND THIS LINE WITHOUT RECORDS SECTION BEING ADVISED, OR NO RECORD ENTRIES WILL BE MADE BELOW THIS LINE.

PROPERTY VALUE	26. PROPERTY	A. CURRENCY	B. JEWELRY	C. FURS CLOTHING	D. VEHICLE (LOCAL)	E. OFFICE EQUIPMENT	F. RADIO, TV CAMERAS	G. FIREARMS	H. HOUSE-HOLD GOODS
	STOLEN	\$	\$	\$	\$	\$	\$	\$	\$
	RECOVERED	\$	\$	\$	\$	\$	\$	\$	\$
	26. PROPERTY	I. CONSUMABLES	J. LIVESTOCK	K. DRUGS	L. MARINE ITEMS	M. CONSTRUCTION ITEMS	N. LAWN AND GARDEN	O. SPORTING GOODS	P. MISC BICYCLE
	STOLEN	\$	\$	\$	\$	\$	\$	\$	\$
	RECOVERED	\$	\$	\$	\$	\$	\$	\$	\$

27. PROPERTY RECOVERED: LOCALLY ____ OTHER JURISDICTION ____ (INSERT O OR L)

PROPERTY ITEMIZATION	PROPERTY STOLEN/RECOVERED ITEMIZATION, USE THE FOLLOWING FORMAT				
	28. QUANTITY	29. ARTICLE NAME	30. BRAND NAME	31. SERIAL NUMBER	
					S <input type="checkbox"/> R <input type="checkbox"/>
					S <input type="checkbox"/> R <input type="checkbox"/>
					S <input type="checkbox"/> R <input type="checkbox"/>
					S <input type="checkbox"/> R <input type="checkbox"/>
					S <input type="checkbox"/> R <input type="checkbox"/>

33. PROPERTY DAMAGE AMOUNT \$ _____ 34. INSURANCE COMPANY _____

35. OFFICER ASSAULTED Y N 36. ARSON Y N 37. STRUCTURE CODE _____ 38. DAMAGE \$ _____

47. CIB <input type="checkbox"/>	ENTERED <input type="checkbox"/>	CANCELLED <input type="checkbox"/>	48. TOTAL AMOUNT PROPERTY STOLEN \$ _____
NCIC <input type="checkbox"/>	<input type="checkbox"/>	<input type="checkbox"/>	
OTHER BROADCAST <input type="checkbox"/>	<input type="checkbox"/>	<input type="checkbox"/>	49. TOTAL AMOUNT PROPERTY RECOVERED \$ _____

50. IS REPORT CONTINUED? YES NO 51. CAUTION INDICATORS, ATLS ETC.

52. DATA PROCESS INFORMATION:

COMPUTER ENTERED DATE 3.8.99
 MICROFILM INDEXED INITIAL RS

IS CASE CLASSIFICATION CORRECT? (Y) N
 IF N HAS CORRECTION BEEN MADE? N

53. FILE APPROVAL
 BY [Signature] DATE 03/08/99

1. CASE # **S99 No 01211** 2. CLASSIFICATION **6301** 3. CENSUS **14014**

4. INCIDENT **CS/S99-00242**

5. INCIDENT LOCATION **Neenah Paper**

6. NAME LAST-FIRST-MI **[REDACTED] 17526** 7. D.O.B. **[REDACTED]**

8. ADDRESS **[REDACTED]** 9. TX-HOME **[REDACTED]**

11. CITY **[REDACTED]** STATE **[REDACTED]** ZIP **[REDACTED]** 10. TX-BUSINESS **[REDACTED]**

12. DETAILS
Caller states that an employee at Neenah

Paper [REDACTED] Kimberely DR Neenah drove a veh

to work the other day that may be a suspect in the hit & run. It is a Blazer blue/beige in color with grill damage. Employee is

2130 2-10-99

14. REC'D	15. DISP	16. 10-23	17. 10-24
13. DAY			
SUN 1	THU 5		
MON 2	FRI 6		
TUE 3	SAT 7		
WED 4			

MANITOWOC COUNTY SHERIFF INCIDENT CARD

18. ASSIGNED
M130 **9129**
BUSHMAN **H/H**

19. REC. BY **926** 20. DIS. BY
 22. TYPE OF REPORT
 1. INCIDENT
 2. ACCIDENT
 3. CITATION
 4. NONE

21. HOW REC'D.
 1. 911
 2. POLICE RADIO
 3. PHONE
 4. TTY
 5. IN PERSON
 6. ON VIEW
 7. OFF. OFF DUTY
 8. C.B. RADIO
 9. OTHER
 23. STATUS
 1. UNFOUNDED
 2. PNL
 3. OTHER
 4. CLEARED
 5. EXCEPT CLEARED

24. DATE CLEARED **03/02/99**
 25. OFFENSE TYPE
 1. ADULT NA
 2. JUVENILE
 3. UNKNOWN

39. (CODE S-SUSPECT W-WITNESS V-VICTIM O-OTHER)				42. ADDRESS		43. TELEPHONE	
CODE	40. NAME-LAST	FIRST	MI	41. D.O.B.			

021099 Norman Falish. He lives on Hwy 41 near the BR50/OU50 Co line. He works 7am - 3pm this week and will be working 3p - 11pm next week 2/15. They work alternating weeks of 1st and 2nd shift. If you need more info you may contact the comp. Compl said Norman drives several different vehicles, but happened to drive this suspicious one this last week. as/926

02/16/99 1615hrs Contact by phone made with [REDACTED] at Neenah Paper [REDACTED]. He advised Norman Falish is on vacation this week. The vehicle was described to Officer. Only 1/3 of the grille is gone and as far as he could see there was no sheet metal damage around the the grille out. The vehicle has large aggressive tires as he remembered and generally in poor condition. [REDACTED] will check much closer next week and if there is any question the vehicle fits Officer's description he will call back. He stated, "I don't think this is the vehicle after talking with you, but I thought I should question it." Close Out. M.J. Bushman

pp 850

45. IF COMPLAINANT DIFFERENT THEN CALLER, ENTER NAME, ADDRESS, D.O.B., TELEPHONE.

46. IF CODE O (OTHER) IS USED IN FIELD #39, EXPLAIN.

INCIDENT REPORT: NOTE: IF SECTION 22 ABOVE HAS NUMBER 4 CHECKED, DO NOT GO BEYOND THIS LINE WITHOUT RECORDS SECTION BEING ADVISED, OR NO RECORD ENTRIES WILL BE MADE BELOW THIS LINE.

PROPERTY VALUE	26. PROPERTY	A. CURRENCY	B. JEWELRY	C. FURS CLOTHING	D. VEHICLE (LOCAL)	E. OFFICE EQUIPMENT	F. RADIO, TV CAMERAS	G. FIREARMS	H. HOUSE-HOLD GOODS
	STOLEN	\$	\$	\$	\$	\$	\$	\$	\$
	RECOVERED	\$	\$	\$	\$	\$	\$	\$	\$
	26. PROPERTY	I. CONSUMABLES	J. LIVESTOCK	K. DRUGS	L. MARINE ITEMS	M. CONSTRUCTION ITEMS	N. LAWN AND GARDEN	O. SPORTING GOODS	P. MISC BICYCLE
	STOLEN	\$	\$	\$	\$	\$	\$	\$	\$
	RECOVERED	\$	\$	\$	\$	\$	\$	\$	\$

27. PROPERTY RECOVERED: LOCALLY ____ OTHER JURISDICTION ____ (INSERT O OR L)

PROPERTY ITEMIZATION	PROPERTY STOLEN/RECOVERED ITEMIZATION, USE THE FOLLOWING FORMAT				
	28. QUANTITY	29. ARTICLE NAME	30. BRAND NAME	31. SERIAL NUMBER	32. CODE
					S R <input type="checkbox"/> <input type="checkbox"/>
					S R <input type="checkbox"/> <input type="checkbox"/>
					S R <input type="checkbox"/> <input type="checkbox"/>
					S R <input type="checkbox"/> <input type="checkbox"/>

33. PROPERTY DAMAGE AMOUNT \$ _____ 34. INSURANCE COMPANY _____

35. OFFICER ASSAULTED Y N 36. ARSON Y N 37. STRUCTURE CODE _____ 38. DAMAGE \$ _____

47. CIB ENTERED CANCELLED
 NCIC
 OTHER BROADCAST

48. TOTAL AMOUNT PROPERTY STOLEN \$ _____

49. TOTAL AMOUNT PROPERTY RECOVERED \$ _____

50. IS REPORT CONTINUED? YES NO

51. CAUTION INDICATORS, ATLS ETC.

52. DATA PROCESS INFORMATION:
 COMPUTER ENTERED DATE 3.8.99
 MICROFILM INDEXED INITIAL AS
 IS CASE CLASSIFICATION CORRECT? Y N
 IF N HAS CORRECTION BEEN MADE? Y N

53. FILE APPROVAL
 BY KS DATE 0308 99

5. INCIDENT LOCATION				9/21/99	
6. NAME - LAST - FIRST - MI <i>Anonymous</i>		7. D.O.B.			
8. ADDRESS		9. TX-HOME		19. REC. BY <i>9/21</i>	
11. CITY STATE ZIP		10. TX-BUSINESS		20. DIS. BY	
12. DETAILS <i>See attached</i>				21. HOW REC'D. 1. 911 2. POLICE RADIO 3. PHONE 4. TTY 5. IN PERSON 6. ON VIEW 7. OFF. OFF DUTY 8. C.B. RADIO 9. OTHER	
				22. TYPE OF REPORT 1. INCIDENT 2. ACCIDENT 3. CITATION 4. NONE	
				23. STATUS 1. UNFOUNDED 2. PNL 3. OTHER 4. CLEARED 5. EXCEPT CLEARED	
				24. DATE CLEARED <i>02/11/99</i>	
				25. OFFENSE TYPE 1. ADULT <input type="checkbox"/> NA <input type="checkbox"/> 2. JUVENILE <input type="checkbox"/> 3. UNKNOWN <input type="checkbox"/>	
				21A. M.O.	

39. (CODE S-SUSPECT W-WITNESS V-VICTIM O-OTHER)					
CODE	40. NAME-LAST	FIRST	MI	41. D.O.B.	42. ADDRESS
O	FEDA	KEVIN	M	[REDACTED]	[REDACTED] Kent St, Mishicot

02/11/99 @ 0913 Hrs.: Dispatch received an anonymous complaint of a suspicious vehicle parked on Madison St in the City of Manitowoc with no tailgate but with front right damage. The RP forwarded by the caller was WI truck BJ84010.

In running a 10-28, it indicated this vehicle is a 1985 Ford pickup truck.

Due to the fact the RPs may be on the wrong vehicle, I checked this location for the vehicle. I confirmed it was a blue Ford pickup, indicating it does not match our suspect vehicle.

No further action taken. EJGlaeser *EJG* /bjc

S99 No 01271

45. IF COMPLAINANT DIFFERENT THEN CALLER, ENTER NAME, ADDRESS, D.O.B., TELEPHONE.

46. IF CODE O (OTHER) IS USED IN FIELD #39, EXPLAIN.

INCIDENT REPORT: NOTE: IF SECTION 22 ABOVE HAS NUMBER 4 CHECKED, DO NOT GO BEYOND THIS LINE WITHOUT RECORDS SECTION BEING ADVISED, OR NO RECORD ENTRIES WILL BE MADE BELOW THIS LINE.

PROPERTY VALUE	26. PROPERTY	A. CURRENCY	B. JEWELRY	C. FURS CLOTHING	D. VEHICLE (LOCAL)	E. OFFICE EQUIPMENT	F. RADIO, TV CAMERAS	G. FIREARMS	H. HOUSE-HOLD GOODS
	STOLEN	\$	\$	\$	\$	\$	\$	\$	\$
	RECOVERED	\$	\$	\$	\$	\$	\$	\$	\$
	26. PROPERTY	I. CONSUMABLES	J. LIVESTOCK	K. DRUGS	L. MARINE ITEMS	M. CONSTRUCTION ITEMS	N. LAWN AND GARDEN	O. SPORTING GOODS	P. MISC BICYCLE
	STOLEN	\$	\$	\$	\$	\$	\$	\$	\$
	RECOVERED	\$	\$	\$	\$	\$	\$	\$	\$

27. PROPERTY RECOVERED: LOCALLY _____ OTHER JURISDICTION _____ (INSERT O OR L)

PROPERTY ITEMIZATION	PROPERTY STOLEN/RECOVERED ITEMIZATION, USE THE FOLLOWING FORMAT				
	28. QUANTITY	29. ARTICLE NAME	30. BRAND NAME	31. SERIAL NUMBER	
					S <input type="checkbox"/> R <input type="checkbox"/>
					S <input type="checkbox"/> R <input type="checkbox"/>
					S <input type="checkbox"/> R <input type="checkbox"/>
					S <input type="checkbox"/> R <input type="checkbox"/>

33. PROPERTY DAMAGE AMOUNT \$ _____

34. INSURANCE COMPANY _____

35. OFFICER ASSAULTED Y N

36. ARSON Y N

37. STRUCTURE CODE _____ 38. DAMAGE \$ _____

47. CIB	ENTERED <input type="checkbox"/>	CANCELLED <input type="checkbox"/>
NCIC	<input type="checkbox"/>	<input type="checkbox"/>
OTHER BROADCAST	<input type="checkbox"/>	<input type="checkbox"/>

48. TOTAL AMOUNT PROPERTY STOLEN \$ _____

49. TOTAL AMOUNT PROPERTY RECOVERED \$ _____

50. IS REPORT CONTINUED? YES NO

51. CAUTION INDICATORS, ATLS ETC.

52. DATA PROCESS INFORMATION:

COMPUTER ENTERED DATE 2-19-99

MICROFILM INDEXED INITIAL AS

IS CASE CLASSIFICATION CORRECT? Y N
IF N HAS CORRECTION BEEN MADE? Y N

53. FILE APPROVAL

BY _____ DATE

1. CASE # S99 01222	2. CLASSIFICATION 63011	3. CENSUS S2900
4. CODE CS	5. INCIDENT LOCATION S99-00242	
6. NAME - LAST-FIRST-MI Anonymous	7. D.O.B.	
8. ADDRESS	9. TX-HOME	
11. CITY STATE ZIP	10. TX-BUSINESS	
12. DETAILS see attached		
14. REC'D.	15. DISP	16. 10-23
		17. 10-24
13. DAY		
SUN 1	THU 5	
MON 2	FRI 6	
TUE 3	SAT 7	
WED 4		

MANITOWOC COUNTY SHERIFF INCIDENT CARD		
18. ASSIGNED Glaeser 4117 9:29		
19. REC. BY 921	20. DIS. BY	22. TYPE OF REPORT 1. INCIDENT 2. ACCIDENT 3. CITATION 4. NONE
21. HOW REC'D. 1. 911 2. POLICE RADIO 3. PHONE 4. TTY 5. IN PERSON 6. ON VIEW 7. OFF. OFF DUTY 8. C.B. RADIO 9. OTHER	23. STATUS 1. UNFOUNDED 2. PNL 3. OTHER 4. CLEARED 5. EXCEPT CLEARED	24. DATE CLEARED 10/15/99
21A. M.O.	25. OFFENSE TYPE 1. ADULT <input type="checkbox"/> NA <input type="checkbox"/> 2. JUVENILE <input type="checkbox"/> 3. UNKNOWN <input type="checkbox"/>	

2/11/99 0945

39. (CODE S-SUSPECT W-WITNESS V-VICTIM O-OTHER)						
CODE	40. NAME-LAST	FIRST	MI	41. D.O.B.	42. ADDRESS	43. TELEPHONE
0	LALLENSACK	Delores A.			Hecker Road Manitowoc	

02/11/99 @ 0950 Hrs.: I, Deputy E. Glaeser, was informed by Dispatch an anonymous caller contacted them in regard to a strange incident which had been reported. Dispatch advised the anonymous caller made contact at a residence at the end of Hecker Rd, south of Silver Creek Rd, in an effort to sell the party at that residence insurance. The female caller said the man she had contact with at the house talked very strange and made reference to the hit and run accident several times, even though she never brought the subject up. Apparently, the farmer at this residence further stated he had a van in the barn and that was where it was going to stay. Dispatch also relayed that originally when the female made contact at the house, the male party was very agitated and told her to leave the property.

There was no personal information taken from the caller. The caller disconnected the line before Dispatch could get that information. The only information she could relay was that the address was at the end of Hecker Rd, south of Silver Creek Rd.

I informed Lt. O'Hearn that I would be attempting to make contact at this address. I was successful in contacting a female party who had no problem with me checking the barns, garages, and storage sheds on the property. Lt. O'Hearn and I were unable to locate any vehicles, even of a Chevrolet make. Delores Lallensack told officers her father Victor was the owner of the property but was not home. Delores did let us search all buildings on the property. This incident can be considered closed. EJGlaeser *EJG* /bjc

CASE # S99 # Nc 01222

1. CASE # S99 No 01237
 2. CLASSIFICATION 10.310.11
 3. CENSUS 5.310.00

MANITOWOC COUNTY SHERIFF
 INCIDENT CARD

4. INCIDENT S99-00242

18. ASSIGNED Jost 4419
 9219

5. INCIDENT LOCATION [REDACTED]

6. NAME LAST-FIRST-MI [REDACTED] 7. D.O.B. [REDACTED]

8. ADDRESS [REDACTED] 9. TX-HOME [REDACTED]

11. CITY STATE ZIP 10. TX-BUSINESS [REDACTED]

12. DETAILS See Attached.

1718
 1841
 1849
 02-11-99
 10-23
 10-24
 13. DAY
 SUN 1 THU 5
 MON 2 FRI 6
 TUE 3 SAT 7
 WED 4

19. REC. BY 938
 20. DIS. BY
 22. TYPE OF REPORT
 INCIDENT
 ACCIDENT
 CITATION
 NONE
 23. STATUS
 1. UNFOUNDED
 2. PNL
 3. OTHER
 4. CLEARED
 5. EXCEPT CLEARED
 24. DATE CLEARED 03 08 PM
 25. OFFENSE TYPE
 1. ADULT
 2. JUVENILE
 3. UNKNOWN

39. (CODE S-SUSPECT W-WITNESS V-VICTIM O-OTHER)							
CODE	40. NAME-LAST	FIRST	MI	41. D.O.B.	42. ADDRESS	43. TELEPHONE	
0	[REDACTED] 123833	[REDACTED]	[REDACTED]	[REDACTED]	[REDACTED]	[REDACTED]	[REDACTED]

On 02-11-99 at approximately 1730 hrs. I, Deputy Jost, made contact with [REDACTED] at his address reference this complaint. I checked the described Blazer which was parked in the garage for repairs. No damage to the front of the truck, repairs were being made on the motor, this being the reason why it has not been driven. *Phy MJ*

JUVENILE INFO REDACTED

AF 1081

2

CASE # S99 No 01237

45. IF COMPLAINANT DIFFERENT THEN CALLER, ENTER NAME, ADDRESS, D.O.B., TELEPHONE.

46. IF CODE O (OTHER) IS USED IN FIELD #39, EXPLAIN.

INCIDENT REPORT: NOTE: IF SECTION 22 ABOVE HAS NUMBER 4 CHECKED, DO NOT GO BEYOND THIS LINE WITHOUT RECORDS SECTION BEING ADVISED, OR NO RECORD ENTRIES WILL BE MADE BELOW THIS LINE.

PROPERTY VALUE	26. PROPERTY	A. CURRENCY	B. JEWELRY	C. FURS CLOTHING	D. VEHICLE (LOCAL)	E. OFFICE EQUIPMENT	F. RADIO, TV CAMERAS	G. FIREARMS	H. HOUSE-HOLD GOODS
	STOLEN	\$	\$	\$	\$	\$	\$	\$	\$
	RECOVERED	\$	\$	\$	\$	\$	\$	\$	\$
	26. PROPERTY	I. CONSUMABLES	J. LIVESTOCK	K. DRUGS	L. MARINE ITEMS	M. CONSTRUCTION ITEMS	N. LAWN AND GARDEN	O. SPORTING GOODS	P. MISC BICYCLE
STOLEN	\$	\$	\$	\$	\$	\$	\$	\$	
RECOVERED	\$	\$	\$	\$	\$	\$	\$	\$	

27. PROPERTY RECOVERED: LOCALLY _____ OTHER JURISDICTION _____ (INSERT O OR L)

PROPERTY ITEMIZATION	PROPERTY STOLEN/RECOVERED ITEMIZATION, USE THE FOLLOWING FORMAT			
	28. QUANTITY	29. ARTICLE NAME	30. BRAND NAME	31. SERIAL NUMBER
		JUVENILE INFO REDACTED		

33. PROPERTY DAMAGE AMOUNT \$ _____

34. INSURANCE COMPANY _____

35. OFFICER ASSAULTED Y N

36. ARSON Y N

37. STRUCTURE CODE _____

38. DAMAGE \$ _____

47. CIB ENTERED CANCELLED
 NCIC
 OTHER BROADCAST

48. TOTAL AMOUNT PROPERTY STOLEN \$ _____

49. TOTAL AMOUNT PROPERTY RECOVERED \$ _____

50. IS REPORT CONTINUED? YES NO

51. CAUTION INDICATORS, ATLS ETC.

52. DATA PROCESS INFORMATION:

COMPUTER ENTERED DATE 13/8/99

MICROFILM INDEXED INITIAL JS

IS CASE CLASSIFICATION CORRECT? N
 IF N HAS CORRECTION BEEN MADE? N

53. FILE APPROVAL

BY [Signature]

DATE 13/8/99

1 CASE # S99-01242 2. CLASSIFICATION 630.11 3. CENSUS 70000

4. INCIDENT CS | S99-00242

5. INCIDENT LOCATION Brown County

6. NAME - LAST - FIRST - MI CH 11 - FOX TV 7. D.O.B.

ADDRESS 9 TX-HOME 11. CITY STATE ZIP 10 TX-BUSINESS

12. DETAILS
 Scott Martens has been to salvage yard in Pulaski asking for a grill & right front fender for a 85

1910
 02/11/99
 REC'D 14. 15. 16. 17.
 DISP 10-23 10-24
 13. DAY
 SUN 1 THU 5
 MON 2 FRI 6
 TUE 3 SAT 7
 WED 4

MANITOWOC COUNTY SHERIFF
 INCIDENT CARD

18. ASSIGNED Lt. Bushman 4141
 BRSO 9130
 9219

19. REC. BY 925 20. DIS. BY 441
 21. HOW REC'D.
 1. 911
 2. POLICE RADIO
 3. PHONE
 4. TTY
 5. IN PERSON
 6. ON VIEW
 7. OFF. OFF DUTY
 8. C.B. RADIO
 9. OTHER
 21A. M.O.

22. TYPE OF REPORT
 1. INCIDENT
 2. ACCIDENT
 3. CITATION
 4. NONE
 23. STATUS
 1. UNFOUNDED
 2. PNL
 3. OTHER
 4. CLEARED
 5. EXCEPT CLEARED
 24. DATE CLEARED 02/11/99
 25. OFFENSE TYPE
 1. ADULT NA
 2. JUVENILE
 3. UNKNOWN

39. (CODE S-SUSPECT W-WITNESS V-VICTIM O-OTHER)	40. NAME-LAST	FIRST	MI	41. D.O.B.	42. ADDRESS	43. TELEPHONE
O	Karcz Auto Salvage	176244			Jaworski Rd., Pulaski, 54162	
S	Martens	Scott	156763		Floral Dr. Green Bay	

Suburban. SESE

02/11/99 @ 1850 Hrs.: I, Lt. M. Bushman, received a phone call at home from CHANNEL 11 NEWS, TERI BARR. She indicated a Crime Stopper report was made to their station reference SCOTT MARTENS who had been to the KARCZ AUTO SALVAGE yard in Pulaski requesting a grill and right front fender for a 1985 Suburban.

02/11/99 @ 1912 Hrs.: Contact was made by phone with BRSO. I spoke with Lt. Josart. A request was made for the Shift Commander to send an officer by SCOTT MARTENS' residence at Floral Dr, Green Bay, to view this vehicle.

02/12/99 @ 2119 Hrs.: Contact was made by phone with Lt. Josart of BRSO. He advised, this afternoon, an officer made contact with MARTENS. There was minor damage to the grill area on his vehicle. It was explained the damage would have occurred in a car-deer accident. Follow-up on the information showed a car-deer accident involving this vehicle in Brown Co.

This would not be our suspect vehicle. MJBushman /bjc

S99-01242

45. IF COMPLAINANT DIFFERENT THEN CALLER, ENTER NAME, ADDRESS, D.O.B., TELEPHONE.

46. IF CODE O (OTHER) IS USED IN FIELD #39, EXPLAIN.

INCIDENT REPORT: NOTE: IF SECTION 22 ABOVE HAS NUMBER 4 CHECKED, DO NOT GO BEYOND THIS LINE WITHOUT RECORDS SECTION BEING ADVISED, OR NO RECORD ENTRIES WILL BE MADE BELOW THIS LINE.

PROPERTY VALUE	26. PROPERTY	A. CURRENCY	B. JEWELRY	C. FURS CLOTHING	D. VEHICLE (LOCAL)	E. OFFICE EQUIPMENT	F. RADIO, TV CAMERAS	G. FIREARMS	H. HOUSE-HOLD GOODS
	STOLEN	\$	\$	\$	\$	\$	\$	\$	\$
	RECOVERED	\$	\$	\$	\$	\$	\$	\$	\$
	26. PROPERTY	I. CONSUMABLES	J. LIVESTOCK	K. DRUGS	L. MARINE ITEMS	M. CONSTRUCTION ITEMS	N. LAWN AND GARDEN	O. SPORTING GOODS	P. MISC BICYCLE
STOLEN	\$	\$	\$	\$	\$	\$	\$	\$	
RECOVERED	\$	\$	\$	\$	\$	\$	\$	\$	

27. PROPERTY RECOVERED: LOCALLY _____ OTHER JURISDICTION _____ (INSERT O OR L)

PROPERTY ITEMIZATION	PROPERTY STOLEN/RECOVERED ITEMIZATION, USE THE FOLLOWING FORMAT				
	28. QUANTITY	29. ARTICLE NAME	30. BRAND NAME	31. SERIAL NUMBER	32. CODE
					S R <input type="checkbox"/> <input type="checkbox"/>
					S R <input type="checkbox"/> <input type="checkbox"/>
					S R <input type="checkbox"/> <input type="checkbox"/>
					S R <input type="checkbox"/> <input type="checkbox"/>
					S R <input type="checkbox"/> <input type="checkbox"/>

33. PROPERTY DAMAGE AMOUNT \$ _____

34. INSURANCE COMPANY _____

35. OFFICER ASSAULTED Y N

36. ARSON Y N

37. STRUCTURE CODE _____

38. DAMAGE \$ _____

47. CIB ENTERED CANCELLED
 NCIC
 OTHER BROADCAST

48. TOTAL AMOUNT PROPERTY STOLEN \$ _____

49. TOTAL AMOUNT PROPERTY RECOVERED \$ _____

50. IS REPORT CONTINUED? YES NO

51. CAUTION INDICATORS, ATLS ETC.

52. DATA PROCESS INFORMATION:

COMPUTER ENTERED DATE 13.8.99
 MICROFILM INDEXED INITIAL AS

IS CASE CLASSIFICATION CORRECT? Y N
 IF N HAS CORRECTION BEEN MADE?

53. FILE APPROVAL

BY [Signature]

DATE 02/16/99

1. CASE # S99 No 01257		2. CLASSIFICATION 6.310.11		3. CENSUS 6.0100.0	
4. INCIDENT See S99-00242					
INCIDENT LOCATION					
6. NAME - LAST - FIRST - MI				7. D.O.B.	
8. ADDRESS				9. TX-HOME	
11. CITY			STATE	ZIP	
10. TX-BUSINESS					
12. DETAILS DEPUTY COLBORN REQ. INCIDENT FOR ABOVE					
14. REC'D	15. DISP	16. 10-23	17. 10-24	13. DAY	
				SUN 1	THU 5
				MON 2	FRI 6
				TUE 3	SAT 7
				WED 4	
MANITOWOC COUNTY SHERIFF INCIDENT CARD					
18. ASSIGNED MTSO				929	
COLBORN				4312	
19. REC. BY 930		20. DIS. BY N/A		22. TYPE OF REPORT	
21. HOW REC'D.		1. 911		1. INCIDENT	
2. POLICE RADIO		2. ACCIDENT		2. CITATION	
3. PHONE		3. CITATION		3. NONE	
4. TTY		4. NONE		23. STATUS	
5. IN PERSON		1. UNFOUNDED		2. PNL	
6. ON VIEW		2. CLEARED		3. OTHER	
7. OFF. OFF DUTY		3. EXCEPT CLEARED		24. DATE CLEARED	
8. C.B. RADIO		10/16/99		25. OFFENSE TYPE	
9. OTHER		1. ADULT <input type="checkbox"/>		2. JUVENILE <input type="checkbox"/>	
21A.M.O.		3. UNKNOWN <input type="checkbox"/>			

02/12/99 @ 1000 Hrs.: I, Deputy A. Colborn, was assigned this incident by D.I. Tisler who informed me an MTSO Jail inmate informed the Jail Administrator he had some information reference the fatal hit and run (see incident S99-00242).

I responded to MTSO Jail where I made contact with Jail Administrator R. Aukamp who gave me a copy of an Inmate Jail Request Form. The request form stated [redacted] wished to talk to someone about the hit and run which "killed that boy on Clover Rd by BIL-MAR" (see attached copy of the request form).

I had [redacted] brought down to the 1st floor Interview Room of MTSO Jail where I spoke with him. [redacted] informed me he has been an inmate at MTSO Jail for the last 14 months. [redacted] further informed me he believes [redacted] PHILIP KOCH, may possibly have some information reference the fatal hit and run.

[redacted] asked I keep his name anonymous. [redacted] further stated, when he was incarcerated, he purchased a 1989 Chevrolet van which had a grill very similar to the one he observed in the picture in the Herald-Times Reporter. [redacted] stated, when he became incarcerated, [redacted] (PHILIP) took over possession of the van and frequently drove it. [redacted] stated, when he was incarcerated, he purchased the van for \$8000. He stated the van was in good shape with no front end damage. [redacted] stated he now received a letter from PHILIP (see attached) in which PHILIP is requesting the Title for the van so he can "get rid of it." [redacted] stated he feels this is very odd and does not know why PHILIP wants to get rid of the van. [redacted] then provided me with PHILIP'S home address where he believes the van may be kept. [redacted] again requested I not mention his name when I spoke with PHILIP which I agreed to do.

I responded to [redacted] Green St, Manitowoc, where I observed a white Chevrolet van bearing WI RP BA94794. This was the van described to me by [redacted]. This van was in the backyard of the residence located at [redacted] Green St.

I made contact with PHILIP'S wife who gave me permission to look at the van and inspect it.

S99 No 01257

45. IF COMPLAINANT DIFFERENT THEN CALLER, ENTER NAME, ADDRESS, D.O.B., TELEPHONE.

46. IF CODE O (OTHER) IS USED IN FIELD #39, EXPLAIN.

INCIDENT REPORT: NOTE: IF SECTION 22 ABOVE HAS NUMBER 4 CHECKED, DO NOT GO BEYOND THIS LINE WITHOUT RECORDS SECTION BEING ADVISED, OR NO RECORD ENTRIES WILL BE MADE BELOW THIS LINE.

PROPERTY VALUE	26. PROPERTY	A. CURRENCY	B. JEWELRY	C. FURS CLOTHING	D. VEHICLE (LOCAL)	E. OFFICE EQUIPMENT	F. RADIO, TV CAMERAS	G. FIREARMS	H. HOUSE-HOLD GOODS
	STOLEN	\$	\$	\$	\$	\$	\$	\$	\$
	RECOVERED	\$	\$	\$	\$	\$	\$	\$	\$
	26. PROPERTY	I. CONSUMABLES	J. LIVESTOCK	K. DRUGS	L. MARINE ITEMS	M. CONSTRUCTION ITEMS	N. LAWN AND GARDEN	O. SPORTING GOODS	P. MISC BICYCLE
STOLEN	\$	\$	\$	\$	\$	\$	\$	\$	
RECOVERED	\$	\$	\$	\$	\$	\$	\$	\$	

27. PROPERTY RECOVERED: LOCALLY _____ OTHER JURISDICTION _____ (INSERT O OR L)

PROPERTY ITEMIZATION	PROPERTY STOLEN/RECOVERED ITEMIZATION, USE THE FOLLOWING FORMAT				32. CODE
	28. QUANTITY	29. ARTICLE NAME	30. BRAND NAME	31. SERIAL NUMBER	
					S R <input type="checkbox"/> <input type="checkbox"/>
					S R <input type="checkbox"/> <input type="checkbox"/>
					S R <input type="checkbox"/> <input type="checkbox"/>
					S R <input type="checkbox"/> <input type="checkbox"/>
					S R <input type="checkbox"/> <input type="checkbox"/>

33. PROPERTY DAMAGE AMOUNT \$ _____

34. INSURANCE COMPANY _____

35. OFFICER ASSAULTED Y N

36. ARSON Y N

37. STRUCTURE CODE _____

38. DAMAGE \$ _____

47. CIB ENTERED CANCELLED
 NCIC
 OTHER BROADCAST

48. TOTAL AMOUNT PROPERTY STOLEN \$ _____

49. TOTAL AMOUNT PROPERTY RECOVERED \$ _____

50. IS REPORT CONTINUED? YES NO

51. CAUTION INDICATORS, ATLS ETC.

52. DATA PROCESS INFORMATION:

COMPUTER ENTERED DATE 3/8/99
 MICROFILM INDEXED INITIAL KS

53. FILE APPROVAL

IS CASE CLASSIFICATION CORRECT? Y N
 IF N HAS CORRECTION BEEN MADE? Y N

BY [Signature] DATE 02/16/99

MANITOWOC COUNTY SHERIFF'S DEPARTMENT
FOLLOW-UP REPORT

Page: 2

CASE NUMBER: 599-01257 CLASSIFICATION: _____

INCIDENT: _____

DATE AND TIME: _____

REPORT CONTINUED:

were broken out on each side of the van, and the grill was not properly installed. It appeared to me someone changed the grill.

I, Deputy Colborn, took Polaroid photos of the damage to the van which are attached. I then asked to speak with PHILIP. I was informed PHILIP was currently at his place of employment.

I brought the photos to MTSO Jail where I again spoke with [REDACTED] and showed him the photos. [REDACTED] informed me the windshield of the van had been cracked prior to his incarceration, but the damage to the front of the van was new. [REDACTED] stated there was no damage whatsoever to the front of his van when he began his incarceration 14 months ago.

I informed Lt. M. Bushman of this incident and requested he do further follow-up as I was unable to locate PHILIP during my tour of duty.

02/12/99 @ 2130 Hrs.: Lt. Bushman attempted contact at [REDACTED] Green St, Manitowoc, to interview PHILIP. Lt. Bushman spoke with PHILIP'S wife and viewed the 1989 Chevy van. He found the headlight bezels on the left and right were broken; however, the headlamps were intact. The grill was cracked but in place. Lt. Bushman found the bumper to be bent but rust-coated. The tire tread did not match the tire tread of the suspect vehicle. It appeared to Lt. Bushman and me that the vehicle had been sitting a long time and that there was no metal underlying structural damage.

This vehicle does not appear to be the suspect vehicle for the hit and run.

02/12/99 @ 2140 Hrs.: Contact was made with PHILIP at his residence. Lt. Bushman interviewed PHILIP and found, approximately 6 months ago, PHILIP removed [REDACTED] van from the Sheboygan Co. Impound yard. PHILIP stated it was damaged while moving it as they attempted to push the van with a truck. Apparently, the bumpers did not quite match up. Lt. Bushman stated PHILIP informed him the van has been parked at [REDACTED] Green St and has not moved since then.

This does not appear to be our suspect vehicle for the hit and run. This incident can be considered closed at this time. ALColborn /bjc

Dear [REDACTED]

I haven't heard from you don't know what's going on, but I need to get that title for that van so I can get rid of it for you enclosed is \$5.00 in your acct. so you can write & let me know how I can get it if I don't get it out they want to lock storage on it & the van quit worth what they want to charge do you know anything. What's going on or when you'll be going to court. If so let me know or call as I said. I am sending \$5.00 along with this letter so you'll have some stamp money.

[REDACTED] Phil

MANITOWOC COUNTY JAIL REQUEST FORM

(PRINT)

LAST NAME: [REDACTED]

CELL LOCATION

4D2 FLOOR 4th

CIRCLE ONE OF THE FOLLOWING:

JAIL ADMINISTRATOR:

DUTY JAILOR:

MEDICAL/NURSE:

PUBLIC DEFENDER:

HUBER OFFICER:

OTHER:

as soon as possible

I need to talk to someone about that Hit and Run that killed that boy on clover Rd by Billmor
Thank you

INMATE SIGNATURE:

[REDACTED]

DATE:

2/12/99

DISPOSITION:

DATE:

APPROVED:

DENIED:

SIGNATURE:

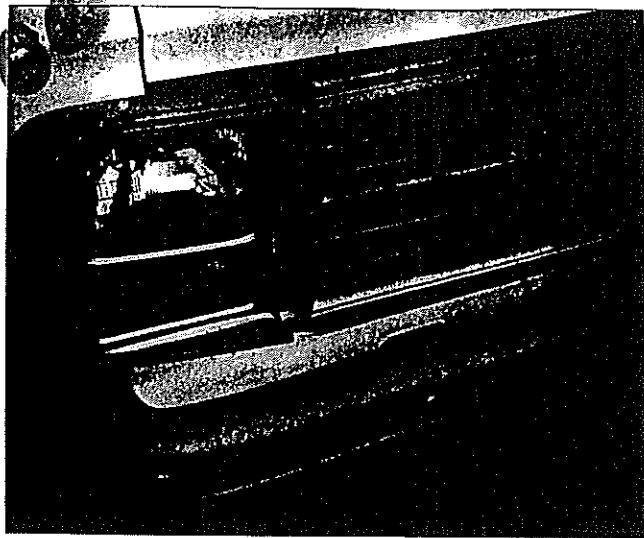

S99-01257
02/12/99 ayc #432

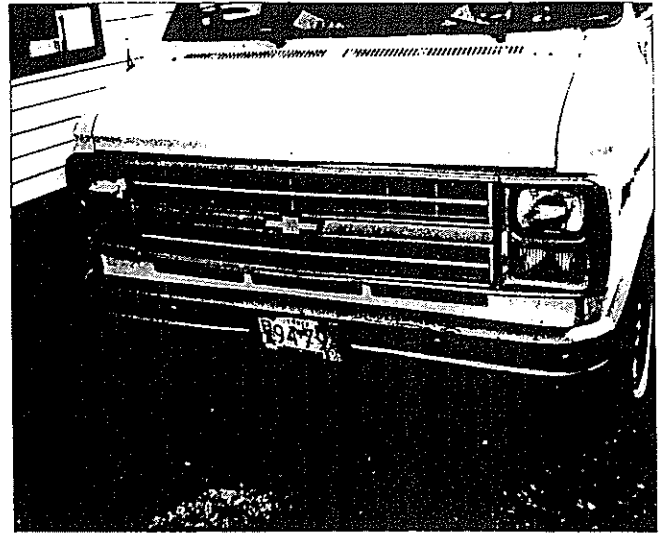

S99-01257
02/12/99 ayc #432

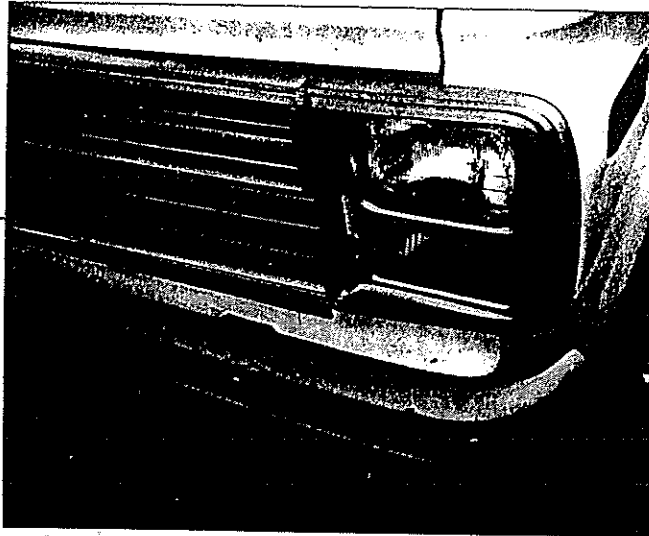

S99-01257
02/12/99 ayc #432

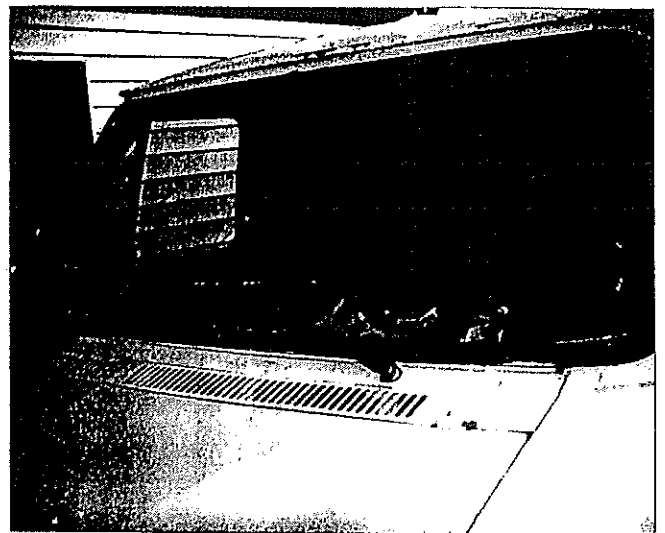

S99-01257
02/12/99 ayc #432

1. CASE # S99 No 01238 | 2. CLASSIFICATION 10.310.11 | 3. CENSUS 3.510.00

4. INCIDENT C.S. 1-599-00242

INCIDENT LOCATION MISHCOG HS

6. NAME- LAST-FIRST-MI [Redacted] | 7. D.O.B. (2)

8. ADDR [Redacted] | 9. TX-HOME

11. CITY STATE ZIP | 10 TX-BUSINESS

12. DETAILS See Attached.

1714
02-11-99
13. DAY
SUN 1 THU 5
MON 2 FRI 6
TUE 3 SAT 7
WED 4

MANITOWOC COUNTY SHERIFF
INCIDENT CARD

18. ASSIGNED

19. REC. BY 930 | 20. DIS. BY
22. TYPE OF REPORT
1. INCIDENT
2. ACCIDENT
3. CITATION
4. NONE

21. HOW REC'D.
1. 911
2. POLICE RADIO
3. PHONE
4. TTY
5. IN PERSON
6. ON VIEW
7. OFF. OFF DUTY
8. C.B. RADIO
9. OTHER
23. STATUS
1. UNFOUNDED
2. PNL
3. OTHER
4. CLEARED
5. EXCEPT CLEARED

24. DATE CLEARED 02/12/99
25. OFFENSE TYPE
1. ADULT NA
2. JUVENILE
3. UNKNOWN

39. (CODE S-SUSPECT W-WITNESS V-VICTIM O-OTHER)						
CODE	40. NAME-LAST	FIRST	MI	41. D.O.B.	42. ADDRESS	43. TELEPHONE

02/16/99 1452hrs Contact made by phone with R.Sieracki and information for this complaint passed on. He will look into a general statement via highschool announcements and look into High School female students named [Redacted] M.J.Bushman
 02/17/99 1800hrs Contact was made with R.Sieracki. General announcement was made, and he checked with several [Redacted] in Middle and High Schools, negative at this time. M.J.Bushman
 03/30/99 Nothing further has been produced through the announcements or personal interviews with students by Off. Sieracki. Close out. M.J.Bushman
 ENTERED ETC

JUVENILE INFO REDACTED

45. IF COMPLAINANT DIFFERENT THEN CALLER, ENTER NAME, ADDRESS, D.O.B., TELEPHONE.

46. IF CODE O (OTHER) IS USED IN FIELD #39, EXPLAIN.

INCIDENT REPORT: NOTE: IF SECTION 22 ABOVE HAS NUMBER 4 CHECKED, DO NOT GO BEYOND THIS LINE WITHOUT RECORDS SECTION BEING ADVISED, OR NO RECORD ENTRIES WILL BE MADE BELOW THIS LINE.

PROPERTY VALUE	26. PROPERTY	A. CURRENCY	B. JEWELRY	C. FURS CLOTHING	D. VEHICLE (LOCAL)	E. OFFICE EQUIPMENT	F. RADIO, TV CAMERAS	G. FIREARMS	H. HOUSEHOLD GOODS
	STOLEN	\$	\$	\$	\$	\$	\$	\$	\$
	RECOVERED	\$	\$	\$	\$	\$	\$	\$	\$
	26. PROPERTY	I. CONSUMABLES	J. LIVESTOCK	K. DRUGS	L. MARINE ITEMS	M. CONSTRUCTION ITEMS	N. LAWN AND GARDEN	O. SPORTING GOODS	P. MISC BICYCLE
	STOLEN	\$	\$	\$	\$	\$	\$	\$	\$
	RECOVERED	\$	\$	\$	\$	\$	\$	\$	\$

27. PROPERTY RECOVERED: LOCALLY _____ OTHER JURISDICTION _____ (INSERT O OR L)

PROPERTY ITEMIZATION	PROPERTY STOLEN/RECOVERED ITEMIZATION, USE THE FOLLOWING FORMAT				
	28. QUANTITY	29. ARTICLE NAME	30. BRAND NAME	31. SERIAL NUMBER	32. CODE
					S R <input type="checkbox"/> <input type="checkbox"/>
					S R <input type="checkbox"/> <input type="checkbox"/>
					S R <input type="checkbox"/> <input type="checkbox"/>
					S R <input type="checkbox"/> <input type="checkbox"/>

33. PROPERTY DAMAGE AMOUNT \$ _____

34. INSURANCE COMPANY _____

35. OFFICER ASSAULTED Y N

36. ARSON Y N

37. STRUCTURE CODE _____

38. DAMAGE \$ _____

47. CIB ENTERED CANCELLED
 NCIC
 OTHER BROADCAST

48. TOTAL AMOUNT PROPERTY STOLEN \$ _____

49. TOTAL AMOUNT PROPERTY RECOVERED \$ _____

50. IS REPORT CONTINUED? YES NO

51. CAUTION INDICATORS, ATLS ETC.

52. DATA PROCESS INFORMATION:

COMPUTER ENTERED DATE 6/29/99
 MICROFILM INDEXED INITIAL KS

IS CASE CLASSIFICATION CORRECT?
 IF N HAS CORRECTION BEEN MADE? Y N

53. FILE APPROVAL

BY [Signature]

DATE 10/2/99

1. CASE # S99 No 01506 | 2. CLASSIFICATION 13041 | 3. CENSUS 1,410,114

MANITOWOC COUNTY SHERIFF
INCIDENT CARD

4. INCIDENT Found Property / S99-00242
 5. INCIDENT LOCATION CTH CR
 6. NAME - LAST-FIRST-MI SCHMIDT Sharon I
 7. D.O.B. [REDACTED]
 8. ADDRESS [REDACTED] CTH CR
 9. TX-HOME [REDACTED]
 10. TX-BUSINESS [REDACTED]
 11. CITY STATE ZIP Manitowoc WI 53120

18. ASSIGNED Colborn 41312

12. DETAILS Found a 1/2 inch piece of amber plastic just south of residence on west side. May possibly from susp veh in fatal H&R S99-00242

02/21/99 1538
 1600
 1708
 1716
 66/15/99
 14. REC'D
 15. DISP
 16. 10-23
 17. 10-24
 13-DAY
 SUN 1 THU 5
 MON 2 FRI 6
 TUE 3 SAT 7
 WED 4

19. REC. BY 935
 20. DIS. BY 435
 21. HOW REC'D.
 1. 911
 2. POLICE RADIO
 3. PHONE
 4. TTY
 5. IN PERSON
 6. ON VIEW
 7. OFF. OFF DUTY
 8. C.B. RADIO
 9. OTHER
 21A. M.O.
 22. TYPE OF REPORT
 1. INCIDENT
 2. ACCIDENT
 3. CITATION
 4. NONE
 23. STATUS
 1. UNFOUNDED
 2. PNL
 3. OTHER
 4. CLEARED
 5. EXCEPT CLEARED
 24. DATE CLEARED 03/08/99
 25. OFFENSE TYPE
 1. ADULT NA
 2. JUVENILE
 3. UNKNOWN

39. (CODE S-SUSPECT W-WITNESS V-VICTIM O-OTHER)	40. NAME-LAST	FIRST	MI	41. D.O.B.	42. ADDRESS	43. TELEPHONE
0	SCHMIDT	SHARON	I	[REDACTED]	[REDACTED] CTH CR, Manitowoc	[REDACTED]

02/21/99 @ 1538 Hrs.: I, Deputy A. Colborn, was advised by MTSO Dispatch that SHARON SCHMIDT contacted MTSO and informed them that while walking south on CTH CR, she discovered a small piece of amber plastic which she believed came from a motor vehicle. SCHMIDT stated she believed the piece may have come off the vehicle involved in the fatal hit and run (see incident S99-00242).

02/21/99 @ 1708 Hrs.: I responded to [REDACTED] CTH CR where I made contact with SHARON SCHMIDT. SCHMIDT gave me the small amber piece of plastic which I observed to be emblazoned with the Ford logo. I informed SCHMIDT the suspect vehicle in the hit and run was in all likelihood a General Motors product. I informed SCHMIDT, however, I would retain possession of the small piece of amber lens in case the suspect vehicle should happen to be a different make than General Motors.

I believe the amber piece of plastic came from a Ford pickup truck turn signal lens. SCHMIDT stated she found the piece on CTH CR, approximately 150 yards south of her residence in the west ditch area. SCHMIDT further stated she walks this area quite frequently and should she discover any other automotive pieces, she will contact MTSO.

The small piece of amber-colored plastic is attached to this incident. At this time, the suspect vehicle involved in S99-00242 is believed to be a Chevrolet and this piece is clearly marked "Ford." The piece should remain attached to this incident until the suspect vehicle can be located and identified. ALColborn *ALC* /bjc

03/08/99 Lens piece labeled "Ford" was given to Insp Petersen to be disposed of. It is not from the suspect vehicle. KPetersen/ks

S99 No 01506

45. IF COMPLAINT DIFFERENT THEN CALLER, ENTER NAME, ADDRESS, D.O.B., TELEPHONE.

46. IF CODE O (OTHER) IS USED IN FIELD #39, EXPLAIN.

INCIDENT REPORT: NOTE: IF SECTION 22 ABOVE HAS NUMBER 4 CHECKED, DO NOT GO BEYOND THIS LINE WITHOUT RECORDS SECTION BEING ADVISED, OR NO RECORD ENTRIES WILL BE MADE BELOW THIS LINE.

PROPERTY VALUE	26. PROPERTY	A. CURRENCY	B. JEWELRY	C. FURS CLOTHING	D. VEHICLE (LOCAL)	E. OFFICE EQUIPMENT	F. RADIO, TV CAMERAS	G. FIREARMS	H. HOUSE-HOLD GOODS
	STOLEN	\$	\$	\$	\$	\$	\$	\$	\$
	RECOVERED	\$	\$	\$	\$	\$	\$	\$	\$
	26. PROPERTY	I. CONSUMABLES	J. LIVESTOCK	K. DRUGS	L. MARINE ITEMS	M. CONSTRUCTION ITEMS	N. LAWN AND GARDEN	O. SPORTING GOODS	P. MISC BICYCLE
	STOLEN	\$	\$	\$	\$	\$	\$	\$	\$
	RECOVERED	\$	\$	\$	\$	\$	\$	\$	\$

27. PROPERTY RECOVERED: LOCALLY _____ OTHER JURISDICTION ____ (INSERT O OR L)

PROPERTY ITEMIZATION	PROPERTY STOLEN/RECOVERED ITEMIZATION, USE THE FOLLOWING FORMAT				
	28. QUANTITY	29. ARTICLE NAME	30. BRAND NAME	31. SERIAL NUMBER	32. CODE
					S R <input type="checkbox"/> <input type="checkbox"/>
					S R <input type="checkbox"/> <input type="checkbox"/>
					S R <input type="checkbox"/> <input type="checkbox"/>
					S R <input type="checkbox"/> <input type="checkbox"/>

33. PROPERTY DAMAGE AMOUNT \$ _____

34. INSURANCE COMPANY _____

35. OFFICER ASSAULTED Y N

36. ARSON Y N

37. STRUCTURE CODE _____ 38. DAMAGE \$ _____

47. CIB ENTERED CANCELLED
 NCIC
 OTHER BROADCAST

48. TOTAL AMOUNT PROPERTY STOLEN \$ _____

49. TOTAL AMOUNT PROPERTY RECOVERED \$ _____

50. IS REPORT CONTINUED? YES NO

51. CAUTION INDICATORS, ATLS ETC.

52. DATA PROCESS INFORMATION:

COMPUTER ENTERED DATE 3.8.99
 MICROFILM INDEXED INITIAL KS

53. FILE APPROVAL

IS CASE CLASSIFICATION CORRECT? N
 IF N HAS CORRECTION BEEN MADE? N

BY [Signature] DATE 02/08/99

1574-000704
 INCIDENT LOCATION
 STH CR

6. NAME- LAST-FIRST-MI
 ANONYMOUS (2)

7. D.O.B.

8. ADDRESS

9. TX-HOME

11. CITY STATE ZIP

10. TX-BUSINESS

12. DETAILS
 REPORTS SEEING RED CHEV TRUCK
 RP # 626517 WITH GRILL DAMAGE
 IN SHEBOYGAN CTY ON HWY 57 NEAR
 WALDO

2-1
 15:03
 14. REC'D
 15. DISP
 16. 10-23
 17. 10-24
 13. DAY
 SUN 1 THU 5
 MON 2 FRI 6
 TUE 3 SAT 7
 WED 4

MTSO
 Bushman H/47
 19. REC. BY
 939
 20. DIS. BY

22. TYPE OF REPORT
 1. INCIDENT
 2. ACCIDENT
 3. CITATION
 4. NONE

21. HOW REC'D.
 1. 911
 2. POLICE RADIO
 3. PHONE
 4. TTY
 5. IN PERSON
 6. ON VIEW
 7. OFF. OFF DUTY
 8. C.B. RADIO
 9. OTHER

23. STATUS
 1. UNFOUNDED
 2. PNL
 3. OTHER
 4. CLEARED
 5. EXCEPT CLEARED

24. DATE CLEARED
 03/08/99

25. OFFENSE TYPE
 1. ADULT NA
 2. JUVENILE
 3. UNKNOWN

39. (CODE S-SUSPECT W-WITNESS V-VICTIM O-OTHER)	40. NAME- LAST	FIRST	MI	41. D.O.B.	42. ADDRESS	43. TELEPHONE
S	Geiken, Mark R.			1/6/33	STH 57 Lot 98, Plymouth	

02/22/99 1204hrs Contact made with the Asst. Chief at Plymouth PD. He will send an officer by to check vehicle and call me at MTSO while on scene for further detail.

Also discussed was the placing of posters in the Plymouth area and cable access. M.J.B.

02/24/99 1139hrs Plymouth did make contact with suspect to check his vehicle. There was moderate damage to front end. Grille broke up extensively. Owner claims damage caused by large snow drift while 4 wheeling in early January, however he seemed to have memory fade for details. Contact attempted with Officer at scene to verify description of vehicle. Call back expected. M.J. Bushman

02/24/99 1732hrs Call received from Off. Vander Sande, Plymouth PD. He advised the Geiken truck he looked at was set up for off-road mud running 4x4. It was higher than stock, dual rectangular headlamps both sides. He did observe the lower and upper passenger side corners of the grille still in place. He believed the Chev emblem was still in place. It does not sound like this is our vehicle, close out complaint. M.J. Bushman

45. IF COMPLAINANT DIFFERENT THEN CALLER, ENTER NAME, ADDRESS, D.O.B., TELEPHONE.

46. IF CODE O (OTHER) IS USED IN FIELD #39, EXPLAIN.

INCIDENT REPORT: NOTE: IF SECTION 22 ABOVE HAS NUMBER 4 CHECKED, DO NOT GO BEYOND THIS LINE WITHOUT RECORDS SECTION BEING ADVISED, OR NO RECORD ENTRIES WILL BE MADE BELOW THIS LINE.

PROPERTY VALUE	26. PROPERTY	A. CURRENCY	B. JEWELRY	C. FURS CLOTHING	D. VEHICLE (LOCAL)	E. OFFICE EQUIPMENT	F. RADIO, TV CAMERAS	G. FIREARMS	H. HOUSE-HOLD GOODS
	STOLEN	\$	\$	\$	\$	\$	\$	\$	\$
	RECOVERED	\$	\$	\$	\$	\$	\$	\$	\$
	26. PROPERTY	I. CONSUMABLES	J. LIVESTOCK	K. DRUGS	L. MARINE ITEMS	M. CONSTRUCTION ITEMS	N. LAWN AND GARDEN	O. SPORTING GOODS	P. MISC BICYCLE
	STOLEN	\$	\$	\$	\$	\$	\$	\$	\$
	RECOVERED	\$	\$	\$	\$	\$	\$	\$	\$

27. PROPERTY RECOVERED: LOCALLY _____ OTHER JURISDICTION _____ (INSERT O OR L)

PROPERTY ITEMIZATION	PROPERTY STOLEN/RECOVERED ITEMIZATION, USE THE FOLLOWING FORMAT				
	28. QUANTITY	29. ARTICLE NAME	30. BRAND NAME	31. SERIAL NUMBER	32. CODE
					S R <input type="checkbox"/> <input type="checkbox"/>
					S R <input type="checkbox"/> <input type="checkbox"/>
					S R <input type="checkbox"/> <input type="checkbox"/>
					S R <input type="checkbox"/> <input type="checkbox"/>
					S R <input type="checkbox"/> <input type="checkbox"/>

33. PROPERTY DAMAGE AMOUNT \$ _____

34. INSURANCE COMPANY _____

35. OFFICER ASSAULTED Y N

36. ARSON Y N

37. STRUCTURE CODE _____

38. DAMAGE \$ _____

47. CIB ENTERED CANCELLED
 NCIC
 OTHER BROADCAST

48. TOTAL AMOUNT PROPERTY STOLEN \$ _____

49. TOTAL AMOUNT PROPERTY RECOVERED \$ _____

50. IS REPORT CONTINUED? YES NO

51. CAUTION INDICATORS, ATLS ETC.

52. DATA PROCESS INFORMATION:

COMPUTER ENTERED DATE 3/8/99
 MICROFILM INDEXED INITIAL KS

53. FILE APPROVAL

IS CASE CLASSIFICATION CORRECT? N
 IF N HAS CORRECTION BEEN MADE? Y

BY KS DATE 03/08/99

399 IN 00370 1631011 152000

4. INCIDENT
CS/S99-00242

5. INCIDENT LOCATION
TH CR

6. NAME - LAST - FIRST - MI
ANONYMOUS

7. D.O.B.

8. ADDRESS

9. TX-HOME

11. CITY STATE ZIP

10. TX-BUSINESS

12. DETAILS
REPORTS BLUE VEHICLE WITH 1/2
GRILL MISSING ON PASSENGER SIDE
PARKED AT MANITOWOC GRAY IRON FOUNDRY
RP# BE86686

1631 2-1-99

INCIDENT CARD

18. ASSIGNED
MTSA 9129
RUSHMAN 441

19. REC. BY
939

20. DIS. BY

21. HOW REC'D.
1. 911
2. POLICE RADIO
3. PHONE
4. TTY
5. IN PERSON
6. ON VIEW
7. OFF. OFF DUTY
8. C.B. RADIO
9. OTHER

22. TYPE OF REPORT
1. UNIDENT
2. ACCIDENT
3. CITATION
4. NONE

23. STATUS
1. UNFOUNDED
2. PNL
3. OTHER
4. CLEARED
5. EXCEPT CLEARED

24. DATE CLEARED
03 08 99

25. OFFENSE TYPE
1. ADULT NA
2. JUVENILE
3. UNKNOWN

21A. M.O.

14. RECD.	15. DISP	16. 10-23	17. 10-24
13. DAY			
SUN 1	THU 5		
MON 2	FRI 6		
TUE 3	SAT 7		
WED 4			

39. (CODE S-SUSPECT W-WITNESS V-VICTIM O-OTHER)				42. ADDRESS		43. TELEPHONE
CODE	40. NAME-LAST	FIRST	MI	41. D.O.B.		
o	Graupner, William G.				Korinek Rd. Cato	

02/16/99 Following up on this complaint with Dispatcher Karen who assigned the complaint when it first came in. She advised a City unit was sent and the vehicle checked. It was not the suspect vehicle. Close out. M.J. Bushman

11 30 99

2

45. IF COMPLAINANT DIFFERENT THEN CALLER, ENTER NAME, ADDRESS, D.O.B., TELEPHONE.

46. IF CODE O (OTHER) IS USED IN FIELD #39, EXPLAIN.

INCIDENT REPORT: NOTE: IF SECTION 22 ABOVE HAS NUMBER 4 CHECKED, DO NOT GO BEYOND THIS LINE WITHOUT RECORDS SECTION BEING ADVISED, OR NO RECORD ENTRIES WILL BE MADE BELOW THIS LINE.

PROPERTY VALUE	26. PROPERTY	A. CURRENCY	B. JEWELRY	C. FURS CLOTHING	D. VEHICLE (LOCAL)	E. OFFICE EQUIPMENT	F. RADIO, TV CAMERAS	G. FIREARMS	H. HOUSE-HOLD GOODS
	STOLEN	\$	\$	\$	\$	\$	\$	\$	\$
	RECOVERED	\$	\$	\$	\$	\$	\$	\$	\$
	26. PROPERTY	I. CONSUMABLES	J. LIVESTOCK	K. DRUGS	L. MARINE ITEMS	M. CONSTRUCTION ITEMS	N. LAWN AND GARDEN	O. SPORTING GOODS	P. MISC BICYCLE
	STOLEN	\$	\$	\$	\$	\$	\$	\$	\$
	RECOVERED	\$	\$	\$	\$	\$	\$	\$	\$

27. PROPERTY RECOVERED: LOCALLY _____ OTHER JURISDICTION _____ (INSERT O OR L)

PROPERTY ITEMIZATION	PROPERTY STOLEN/RECOVERED ITEMIZATION, USE THE FOLLOWING FORMAT				
	28. QUANTITY	29. ARTICLE NAME	30. BRAND NAME	31. SERIAL NUMBER	32. CODE
					S R <input type="checkbox"/> <input type="checkbox"/>
					S R <input type="checkbox"/> <input type="checkbox"/>
					S R <input type="checkbox"/> <input type="checkbox"/>
					S R <input type="checkbox"/> <input type="checkbox"/>
					S R <input type="checkbox"/> <input type="checkbox"/>

33. PROPERTY DAMAGE AMOUNT \$ _____ 34. INSURANCE COMPANY _____

35. OFFICER ASSAULTED Y N 36. ARSON Y N 37. STRUCTURE CODE _____ 38. DAMAGE \$ _____

47. CIB	ENTERED <input type="checkbox"/>	CANCELLED <input type="checkbox"/>	48. TOTAL AMOUNT PROPERTY STOLEN \$ _____
NCIC	<input type="checkbox"/>	<input type="checkbox"/>	
OTHER BROADCAST	<input type="checkbox"/>	<input type="checkbox"/>	
			49. TOTAL AMOUNT PROPERTY RECOVERED \$ _____

50. IS REPORT CONTINUED? YES NO

51. CAUTION INDICATORS, ATLS ETC.

52. DATA PROCESS INFORMATION:

COMPUTER ENTERED DATE 3.8.99
 MICROFILM INDEXED INITIAL KS
 IS CASE CLASSIFICATION CORRECT? Y N
 IF N HAS CORRECTION BEEN MADE? Y N

53. FILE APPROVAL

BY [Signature] DATE 030899

4. INCIDENT **CS-599-00242**

5. REPORT LOCATION **CTH CR**

6. NAME LAST-FIRST-MI **ANONYMOUS** 7. D.O.B.

8. ADDRESS 9. TX-HOME

11. CITY STATE ZIP 10. TX-BUSINESS

12. DETAILS
 Caller states she over heard in a conversation that Keith A. ²⁰²⁷ Novy [redacted] could be a very good suspect. He drives this route while tavern "hopping" and also used to own two trucks and now owns one. Also stated he owns a sandblasting business in Whitelaw

020299 09

14. REC'D
15. DISP
16. 10-23
17. 10-24

13. DAY
 SUN 1 THU 5
 MON 2 FRI 6
TUE 3 SAT 7
 WED 4

MISO 11249
 M.J. Bushman 9/9/99

19. REC. BY **923** 20. DIS. BY

21. HOW REC'D.
 1. 911
 2. POLICE RADIO
 3. PHONE
 4. TTY
 5. IN PERSON
 6. ON VIEW
 7. OFF. OFF DUTY
 8. C.B. RADIO
 9. OTHER

22. TYPE OF REPORT
 1. INCIDENT
 2. ACCIDENT
 3. CITATION
 4. NONE

23. STATUS
 1. UNFOUNDED
 2. PNL
 3. OTHER
 4. CLEARED
 5. EXCEPT CLEARED

24. DATE CLEARED **103108199**

25. OFFENSE TYPE
 1. ADULT NA
 2. JUVENILE
 3. UNKNOWN

39. (CODE S-SUSPECT W-WITNESS V-VICTIM O-OTHER)				42. ADDRESS		43. TELEPHONE
CODE	40. NAME-LAST	FIRST	MI	41. D.O.B.		
O	Novy, Keith A			[redacted]	[redacted] Polifka Rd., Whitelaw	[redacted]

02/17/99 Contact made at [redacted] Polifka Rd. with Keith Novy. Novy owns 4 trucks only one Chev. which is a 1 ton dump truck with dual rear wheels. The two P/U trucks he owns are both Fords. One has a deisel engine which has been blown out for one month and is parked in with registration BH28203. The second truck is his current operating P/U with registration TSD665. Neither has damage, Novy has not owned a Chev P/U.

When advised of the complaint he stated, "I haven't been down that way for at least three years." Close out. M.J. Bushman

45. IF COMPLAINANT DIFFERENT THEN CALLER, ENTER NAME, ADDRESS, D.O.B., TELEPHONE.

46. IF CODE O (OTHER) IS USED IN FIELD #39, EXPLAIN.

INCIDENT REPORT: NOTE: IF SECTION 22 ABOVE HAS NUMBER 4 CHECKED, DO NOT GO BEYOND THIS LINE WITHOUT RECORDS SECTION BEING ADVISED, OR NO RECORD ENTRIES WILL BE MADE BELOW THIS LINE.

PROPERTY VALUE	26. PROPERTY	A. CURRENCY	B. JEWELRY	C. FURS CLOTHING	D. VEHICLE (LOCAL)	E. OFFICE EQUIPMENT	F. RADIO, TV CAMERAS	G. FIREARMS	H. HOUSE-HOLD GOODS
	STOLEN	\$	\$	\$	\$	\$	\$	\$	\$
	RECOVERED	\$	\$	\$	\$	\$	\$	\$	\$
	26. PROPERTY	I. CONSUMABLES	J. LIVESTOCK	K. DRUGS	L. MARINE ITEMS	M. CONSTRUCTION ITEMS	N. LAWN AND GARDEN	O. SPORTING GOODS	P. MISC BICYCLE
	STOLEN	\$	\$	\$	\$	\$	\$	\$	\$
	RECOVERED	\$	\$	\$	\$	\$	\$	\$	\$

27. PROPERTY RECOVERED: LOCALLY _____ OTHER JURISDICTION _____ (INSERT O OR L)

PROPERTY ITEMIZATION	PROPERTY STOLEN/RECOVERED ITEMIZATION, USE THE FOLLOWING FORMAT				
	28. QUANTITY	29. ARTICLE NAME	30. BRAND NAME	31. SERIAL NUMBER	32. CODE
					S R <input type="checkbox"/> <input type="checkbox"/>
					S R <input type="checkbox"/> <input type="checkbox"/>
					S R <input type="checkbox"/> <input type="checkbox"/>
					S R <input type="checkbox"/> <input type="checkbox"/>

33. PROPERTY DAMAGE AMOUNT \$ _____

34. INSURANCE COMPANY _____

35. OFFICER ASSAULTED Y N 36. ARSON Y N 37. STRUCTURE CODE _____ 38. DAMAGE \$ _____

	ENTERED	CANCELLED
47. CIB	<input type="checkbox"/>	<input type="checkbox"/>
NCIC	<input type="checkbox"/>	<input type="checkbox"/>
OTHER BROADCAST	<input type="checkbox"/>	<input type="checkbox"/>

48. TOTAL AMOUNT PROPERTY STOLEN \$ _____

49. TOTAL AMOUNT PROPERTY RECOVERED \$ _____

50. IS REPORT CONTINUED? YES NO

51. CAUTION INDICATORS, ATLS ETC. 80

52. DATA PROCESS INFORMATION:

COMPUTER ENTERED DATE 13.8.99
 MICROFILM INDEXED INITIAL KS

53. FILE APPROVAL

IS CASE CLASSIFICATION CORRECT? Y N
 IF N HAS CORRECTION BEEN MADE? Y N

BY KS DATE 03.08.99

1. CASE # S99 No 01011 | 2. CLASSIFICATION 6310.11 | 3. CENSUS 7,010,00

4. INCIDENT # [REDACTED] / CS / S99-00242

5. INCIDENT LOCATION Depere - WPS

6. NAME LAST-FIRST-MI Anthony (2) | 7. D.O.B

8. ADDRESS | 9. TX-HOME

11. CITY STATE ZIP | 10. TX-BUSINESS

12. DETAILS See Attached.

02-02-99 2057

14. REC'D | 15. DISP | 16. 10-23 | 17. 10-24
 13. DAY
 SUN 1 THU 5
 MON 2 FRI 6
 TUE 3 SAT 7
 WED 4

MANITOWOC COUNTY SHERIFF INCIDENT CARD

18. ASSIGNED [REDACTED] 929
 [Signature]

19. REC. BY 938 | 20. DIS. BY | 22. TYPE OF REPORT
 1. INCIDENT
 2. ACCIDENT
 3. CITATION
 4. NONE

21. HOW REC'D.
 1. 911
 2. POLICE RADIO
 3. PHONE
 4. TTY
 5. IN PERSON
 6. ON VIEW
 7. OFF. OFF DUTY
 8. C.B. RADIO
 9. OTHER
 23. STATUS
 1. UNFOUNDED
 2. PNL
 3. OTHER
 4. CLEARED
 5. EXCEPT CLEARED

24. DATE CLEARED 03/08/99
 25. OFFENSE TYPE
 1. ADULT NA
 2. JUVENILE
 3. UNKNOWN

39. (CODE S-SUSPECT W-WITNESS V-VICTIM O-OTHER)						
CODE	40. NAME-LAST	FIRST	MI	41. D.O.B.	42. ADDRESS	43. TELEPHONE
S	Ebert Timothy L.			176136	[REDACTED] St. Ann Dr. Green Bay	[REDACTED]

02/16/99 Contact attempted with Complainant [REDACTED] by phone, no answer message left.
 02/17/99 Phone call returned by wife. She was not aware [REDACTED] called a Crimes stopper report so she made contact with him as he is out of town. The suspect is Tim Ebert and he works out of the substation in Depere. Truck grill and windshield replaced by a coworker at the WPS Substation, name unknown.
 Contact made with WPS and phone book information with address listed above is current for Ebert.
 Contact made with Substation Supervisor Dennis Johnson. DOB obtained and work hours, Ebert would be done at 1500hrs. Johnson checked Ebert's vehicle in the parking lot and obtained RP BG17563 listing to Ebert on a 90 Chev P/u. New windshield and grill were in place. Johnson stated he may have had an older truck, he agreed to check and return a call to MISO.
 1559hrs Dennis Johnson returned phone call stating the 90 Chev was the damaged vehicle and looked closer noticing the bumper was not repaired. This is the caller's concerned vehicle and it would be the newer style, not like the suspect vehicle. Ebert had told several fellow employees he hit a tree. This is not suspect vehicle, Close. M.J. Bushman
 As far as Johnson knew Ebert does not own other vehicles. DOT check varifies only the 90 Chev listed to Ebert.

45. IF COMPLAINANT DIFFERENT THEN CALLER, ENTER NAME, ADDRESS, D.O.B., TELEPHONE.

46. IF CODE O (OTHER) IS USED IN FIELD #39, EXPLAIN.

INCIDENT REPORT: NOTE: IF SECTION 22 ABOVE HAS NUMBER 4 CHECKED, DO NOT GO BEYOND THIS LINE WITHOUT RECORDS SECTION BEING ADVISED, OR NO RECORD ENTRIES WILL BE MADE BELOW THIS LINE.

PROPERTY VALUE	26. PROPERTY	A. CURRENCY	B. JEWELRY	C. FURS CLOTHING	D. VEHICLE (LOCAL)	E. OFFICE EQUIPMENT	F. RADIO, TV CAMERAS	G. FIREARMS	H. HOUSE-HOLD GOODS
	STOLEN	\$	\$	\$	\$	\$	\$	\$	\$
	RECOVERED	\$	\$	\$	\$	\$	\$	\$	\$
	26. PROPERTY	I. CONSUMABLES	J. LIVESTOCK	K. DRUGS	L. MARINE ITEMS	M. CONSTRUCTION ITEMS	N. LAWN AND GARDEN	O. SPORTING GOODS	P. MISC BICYCLE
	STOLEN	\$	\$	\$	\$	\$	\$	\$	\$
	RECOVERED	\$	\$	\$	\$	\$	\$	\$	\$

27. PROPERTY RECOVERED: LOCALLY _____ OTHER JURISDICTION _____ (INSERT O OR L)

PROPERTY ITEMIZATION	PROPERTY STOLEN/RECOVERED ITEMIZATION, USE THE FOLLOWING FORMAT				
	28. QUANTITY	29. ARTICLE NAME	30. BRAND NAME	31. SERIAL NUMBER	32. CODE
					S R <input type="checkbox"/> <input type="checkbox"/>
					S R <input type="checkbox"/> <input type="checkbox"/>
					S R <input type="checkbox"/> <input type="checkbox"/>
					S R <input type="checkbox"/> <input type="checkbox"/>

33. PROPERTY DAMAGE AMOUNT \$ _____

34. INSURANCE COMPANY _____

35. OFFICER ASSAULTED Y N

36. ARSON Y N

37. STRUCTURE CODE _____

38. DAMAGE \$ _____

47. CIB ENTERED CANCELLED
 NCIC
 OTHER BROADCAST

48. TOTAL AMOUNT PROPERTY STOLEN \$ _____

49. TOTAL AMOUNT PROPERTY RECOVERED \$ _____

50. IS REPORT CONTINUED? YES NO

51. CAUTION INDICATORS, ATLS ETC.

52. DATA PROCESS INFORMATION:

COMPUTER ENTERED DATE 3/8/99
 MICROFILM INDEXED INITIAL KS

53. FILE APPROVAL

IS CASE CLASSIFICATION CORRECT? N
 IF N HAS CORRECTION BEEN MADE? N

BY [Signature] DATE 3/8/99

1. CASE # S99 No 01014 2. CLASSIFICATION 6.310.11 3. CENSUS 0.31003

4. INCIDENT CS 99-00242

5. INCIDENT LOCATION I-43 Sb rest area

6. NAME LAST-FIRST-MI [REDACTED] 45638 7. D.O.B. [REDACTED]

8. ADDRESS [REDACTED] 9. TX-HOME [REDACTED]

11. CITY STATE ZIP [REDACTED] 10. TX-BUSINESS [REDACTED]

12. DETAILS
 Compl. saw a medium blue
 pick-up w/ a missing grill.
 Had Virginia plates

REC'D 14. 15. 16. 17.
 DISP 10-23 10-24
 13. DAY
 SUN 1 THU 5
 MON 2 FRI 6
 TUE 3 SAT 7
 WED 4

MANITOWOC COUNTY SHERIFF
 INCIDENT CARD

18. ASSIGNED 929
 Tackes 498

19. REC. BY 941 20. DIS. BY 928

21. HOW REC'D.
 1. 911
 2. POLICE RADIO
 3. PHONE
 4. TTY
 5. IN PERSON
 6. ON VIEW
 7. OFF. OFF DUTY
 8. C.B. RADIO
 9. OTHER

22. TYPE OF REPORT
 1. INCIDENT
 2. ACCIDENT
 3. CITATION
 4. NONE

23. STATUS
 1. UNFOUNDED
 2. PNL
 3. OTHER
 4. CLEARED
 5. EXCEPT CLEARED

24. DATE CLEARED 10/10/99

25. OFFENSE TYPE
 1. ADULT NA
 2. JUVENILE
 3. UNKNOWN

21A. M.O.

39. (CODE S-SUSPECT W-WITNESS V-VICTIM O-OTHER)

CODE	40. NAME-LAST	FIRST	MI	41. D.O.B.	42. ADDRESS	43. TELEPHONE

Vehicle was gone upon officers arrival. GDI

45. IF COMPLAINANT DIFFERENT THEN CALLER, ENTER NAME, ADDRESS, D.O.B., TELEPHONE:

46. IF CODE O (OTHER) IS USED IN FIELD #39, EXPLAIN.

INCIDENT REPORT: NOTE: IF SECTION 22 ABOVE HAS NUMBER 4 CHECKED, DO NOT GO BEYOND THIS LINE WITHOUT RECORDS SECTION BEING ADVISED, OR NO RECORD ENTRIES WILL BE MADE BELOW THIS LINE:

PROPERTY VALUE	26. PROPERTY	A. CURRENCY	B. JEWELRY	C. FURS CLOTHING	D. VEHICLE (LOCAL)	E. OFFICE EQUIPMENT	F. RADIO, TV CAMERAS	G. FIREARMS	H. HOUSEHOLD GOOD:
	STOLEN	\$	\$	\$	\$	\$	\$	\$	\$
	RECOVERED	\$	\$	\$	\$	\$	\$	\$	\$
	26. PROPERTY	I. CONSUMABLES	J. LIVESTOCK	K. DRUGS	L. MARINE ITEMS	M. CONSTRUCTION ITEMS	N. LAWN AND GARDEN	O. SPORTING GOODS	P. MISC BICYCLE
	STOLEN	\$	\$	\$	\$	\$	\$	\$	\$
	RECOVERED	\$	\$	\$	\$	\$	\$	\$	\$

27. PROPERTY RECOVERED: LOCALLY _____ OTHER JURISDICTION _____ (INSERT O OR L)

PROPERTY ITEMIZATION	PROPERTY STOLEN/RECOVERED ITEMIZATION, USE THE FOLLOWING FORMAT				
	28. QUANTITY	29. ARTICLE NAME	30. BRAND NAME	31. SERIAL NUMBER	32. CODE
					S R <input type="checkbox"/> <input type="checkbox"/>
					S R <input type="checkbox"/> <input type="checkbox"/>
					S R <input type="checkbox"/> <input type="checkbox"/>
					S R <input type="checkbox"/> <input type="checkbox"/>
					S R <input type="checkbox"/> <input type="checkbox"/>

33. PROPERTY DAMAGE AMOUNT \$ _____

34. INSURANCE COMPANY _____

35. OFFICER ASSAULTED Y N

36. ARSON Y N

37. STRUCTURE CODE _____

38. DAMAGE \$ _____

47. CIB ENTERED CANCELLED
 NCIC
 OTHER BROADCAST

48. TOTAL AMOUNT PROPERTY STOLEN \$ _____

49. TOTAL AMOUNT PROPERTY RECOVERED \$ _____

50. IS REPORT CONTINUED? YES NO

51. CAUTION INDICATORS, ATLS ETC.

52. DATA PROCESS INFORMATION:

COMPUTER ENTERED DATE 2/8/99
 MICROFILM INDEXED INITIAL AS

53. FILE APPROVAL

IS CASE CLASSIFICATION CORRECT?
 IF N HAS CORRECTION BEEN MADE? Y N

BY [Signature]

DATE 02/03/99

1. CASE # S99 No 01023 2. CLASSIFICATION V301 3. CENSUS 141011

4. INCIDENT CS/399-00242

5. INCIDENT LOCATION Memorial Dr

6. NAME [REDACTED] 7. D.O.B. [REDACTED]

8. ADDRESS [REDACTED] 9. TX-HOME [REDACTED]

11. STATE ZIP 10. TX-BUSINESS [REDACTED]

12. DETAILS
 Caller saw an older green Ford pickup w/ grill damage
 RP# BB84686
 older male driving

1415 2-399

14. REC'D
 15. DISP
 16. 10-23
 17. 10-24
 18. DAY
 SUN 1 THU 5
 MON 2 FRI 6
 TUE 3 SAT 7
 WED 4

MANITOWOC COUNTY SHERIFF
 INCIDENT CARD

18. ASSIGNED *Glaeser* 4117
 929

19. REC. BY 926 20. DIS. BY
 22. TYPE OF REPORT
 1. INCIDENT
 2. ACCIDENT
 3. CITATION
 4. NONE
 23. STATUS
 1. UNFOUNDED
 2. PNL
 3. OTHER
 4. CLEARED
 5. EXCEPT CLEARED
 24. DATE CLEARED 030899
 25. OFFENSE TYPE
 1. ADULT NA
 2. JUVENILE
 3. UNKNOWN

39. (CODE S-SUSPECT W-WITNESS V-VICTIM O-OTHER)						
CODE	40. NAME-LAST	FIRST	MI	41. D.O.B.	42. ADDRESS	43. TELEPHONE
0	MILLER	GORDON			[REDACTED] Florence St., Two Rivers	

02/11/99 @ 0530 Hrs.: I, Deputy E. Glaeser, followed up on this Crime Stopper report. A green Ford pickup truck was located at the same address which is listed on the 10-28 for WI truck RP BB84686. I observed this 1977 Ford pickup truck, green in color, with right front grill damage. This vehicle is the wrong make and model of the truck we are looking for. This vehicle can be eliminated from our hit and run suspect list. EJGlaeser *EJG* /bjc

99 5080

N

45. IF COMPLAINANT DIFFERENT THEN CALLER, ENTER NAME, ADDRESS, D.O.B., TELEPHONE.

46. IF CODE O (OTHER) IS USED IN FIELD #39, EXPLAIN.

INCIDENT REPORT: NOTE: IF SECTION 22 ABOVE HAS NUMBER 4 CHECKED, DO NOT GO BEYOND THIS LINE WITHOUT RECORDS SECTION BEING ADVISED, OR NO RECORD ENTRIES WILL BE MADE BELOW THIS LINE.

PROPERTY VALUE	26. PROPERTY	A. CURRENCY	B. JEWELRY	C. FURS CLOTHING	D. VEHICLE (LOCAL)	E. OFFICE EQUIPMENT	F. RADIO, TV CAMERAS	G. FIREARMS	H. HOUSE-HOLD GOODS
	STOLEN	\$	\$	\$	\$	\$	\$	\$	\$
	RECOVERED	\$	\$	\$	\$	\$	\$	\$	\$
	26. PROPERTY	I. CONSUMABLES	J. LIVESTOCK	K. DRUGS	L. MARINE ITEMS	M. CONSTRUCTION ITEMS	N. LAWN AND GARDEN	O. SPORTING GOODS	P. MISC BICYCLE
	STOLEN	\$	\$	\$	\$	\$	\$	\$	\$
	RECOVERED	\$	\$	\$	\$	\$	\$	\$	\$

27. PROPERTY RECOVERED: LOCALLY _____ OTHER JURISDICTION _____ (INSERT O OR L)

PROPERTY ITEMIZATION	PROPERTY STOLEN/RECOVERED ITEMIZATION, USE THE FOLLOWING FORMAT				
	28. QUANTITY	29. ARTICLE NAME	30. BRAND NAME	31. SERIAL NUMBER	
					S <input type="checkbox"/> R <input type="checkbox"/>
					S <input type="checkbox"/> R <input type="checkbox"/>
					S <input type="checkbox"/> R <input type="checkbox"/>
					S <input type="checkbox"/> R <input type="checkbox"/>

33. PROPERTY DAMAGE AMOUNT \$ _____ 34. INSURANCE COMPANY _____

35. OFFICER ASSAULTED Y N 36. ARSON Y N 37. STRUCTURE CODE _____ 38. DAMAGE \$ _____

47. CIB ENTERED CANCELLED
 NCIC
 OTHER BROADCAST

48. TOTAL AMOUNT PROPERTY STOLEN \$ _____

49. TOTAL AMOUNT PROPERTY RECOVERED \$ _____

50. IS REPORT CONTINUED? YES NO

51. CAUTION INDICATORS, ATLS ETC.

52. DATA PROCESS INFORMATION:
 COMPUTER ENTERED DATE 3.5.99
 MICROFILM INDEXED INITIAL KS
 IS CASE CLASSIFICATION CORRECT? Y N
 IF N HAS CORRECTION BEEN MADE? Y N

53. FILE APPROVAL
 BY RP DATE 0808 99

1. CASE # S99 No 01032 2. CLASSIFICATION 6310/11 3. CENSUS 521000

4. INCIDENT 15 / S99-00243
 5. INCIDENT LOCATION

6. [REDACTED] 7. D.O.B. [REDACTED]

8. ADDRESS [REDACTED] 9. TX-HOME [REDACTED]

11. CITY [REDACTED] STATE [REDACTED] ZIP [REDACTED] 10. TX-BUSINESS [REDACTED]

12. DETAILS See Attached.

6310/11 1829 09/03/99

MANITOWOC COUNTY SHERIFF INCIDENT CARD

18. ASSIGNED MBO 929
 JOST 4419

19. REC. BY 935 20. DIS. BY
 21. HOW REC'D.
 1. 911
 2. POLICE RADIO
 3. PHONE
 4. TTY
 5. IN PERSON
 6. ON VIEW
 7. OFF. OFF DUTY
 8. C.B. RADIO
 9. OTHER
 21A. M.O.
 22. TYPE OF REPORT
 1. INCIDENT
 2. ACCIDENT
 3. CITATION
 4. NONE
 23. STATUS
 1. UNFOUNDED
 2. PNL
 3. OTHER
 4. CLEARED
 5. EXCEPT CLEARED
 24. DATE CLEARED 03 P8 99
 25. OFFENSE TYPE
 1. ADULT NA
 2. JUVENILE
 3. UNKNOWN

13. DAY
 SUN 1 THU 5
 MON 2 FRI 6
 TUE 3 SAT 7
 WED 4

39. (CODE S-SUSPECT W-WITNESS V-VICTIM O-OTHER)						
CODE	40. NAME-LAST	FIRST	MI	41. D.O.B.	42. ADDRESS	43. TELEPHONE

101601

02-10-99 This vehicle was checked by myself, Deputy Jost. Vehicle does not match suspect vehicle. No damage to grill area, hood, or windshield. Information was added to S99-00242. JMJ

02-10-99

7

45. IF COMPLAINANT DIFFERENT THEN CALLER, ENTER NAME, ADDRESS, D.O.B., TELEPHONE.

46. IF CODE O (OTHER) IS USED IN FIELD #39, EXPLAIN.

INCIDENT REPORT: NOTE: IF SECTION 22 ABOVE HAS NUMBER 4 CHECKED, DO NOT GO BEYOND THIS LINE WITHOUT RECORDS SECTION BEING ADVISED, OR NO RECORD ENTRIES WILL BE MADE BELOW THIS LINE.

PROPERTY VALUE	26. PROPERTY	A. CURRENCY	B. JEWELRY	C. FURS CLOTHING	D. VEHICLE (LOCAL)	E. OFFICE EQUIPMENT	F. RADIO, TV CAMERAS	G. FIREARMS	H. HOUSE-HOLD GOOD
	STOLEN	\$	\$	\$	\$	\$	\$	\$	\$
	RECOVERED	\$	\$	\$	\$	\$	\$	\$	\$
	26. PROPERTY	I. CONSUMABLES	J. LIVESTOCK	K. DRUGS	L. MARINE ITEMS	M. CONSTRUCTION ITEMS	N. LAWN AND GARDEN	O. SPORTING GOODS	P. MISC BICYCLE
STOLEN	\$	\$	\$	\$	\$	\$	\$	\$	
RECOVERED	\$	\$	\$	\$	\$	\$	\$	\$	

27. PROPERTY RECOVERED: LOCALLY _____ OTHER JURISDICTION _____ (INSERT O OR L)

PROPERTY ITEMIZATION	PROPERTY STOLEN/RECOVERED ITEMIZATION, USE THE FOLLOWING FORMAT				
	28. QUANTITY	29. ARTICLE NAME	30. BRAND NAME	31. SERIAL NUMBER	32. CODE
					S R <input type="checkbox"/> <input type="checkbox"/>
					S R <input type="checkbox"/> <input type="checkbox"/>
					S R <input type="checkbox"/> <input type="checkbox"/>
					S R <input type="checkbox"/> <input type="checkbox"/>
					S R <input type="checkbox"/> <input type="checkbox"/>

33. PROPERTY DAMAGE AMOUNT \$ _____

34. INSURANCE COMPANY _____

35. OFFICER ASSAULTED Y N

36. ARSON Y N

37. STRUCTURE CODE _____

38. DAMAGE \$ _____

47. CIB ENTERED CANCELLED
 NCIC
 OTHER BROADCAST

48. TOTAL AMOUNT PROPERTY STOLEN \$ _____

49. TOTAL AMOUNT PROPERTY RECOVERED \$ _____

50. IS REPORT CONTINUED? YES NO

51. CAUTION INDICATORS, ATLS ETC.

52. DATA PROCESS INFORMATION:

COMPUTER ENTERED DATE 3.8.99
 MICROFILM INDEXED INITIAL AS
 IS CASE CLASSIFICATION CORRECT? Y N
 IF N HAS CORRECTION BEEN MADE? Y N

53. FILE APPROVAL

BY R

DATE 03.28.99

1. CASE # S99 No 01034 2. CLASSIFICATION 6301 3. CENSUS 141011

4. INCIDENT CS / S99-00242

5. INCIDENT LOCATION

6. NAME LAST, FIRST - MI [REDACTED] 117289 7. D.O.B. [REDACTED]

8. ADDRESS [REDACTED] 9. TX - HOME [REDACTED]

10. TX - BUSINESS [REDACTED] STATE ZIP [REDACTED]

12. DETAILS
 Later Blu / Guy 6M
 Blazer RP# HOUSE
 front grill out
 in mtwc

19:05 2:39
 11
 11
 14. REC'D. 15. DISP 16. 10-23 17. 10-24
 13. DAY
 SUN 1 THU 5
 MON 2 FRI 6
 TUE 3 SAT 7
 WED 4

MANITOWOC COUNTY SHERIFF
 INCIDENT CARD

18. ASSIGNED *Ruffin Thomas* 441
 929

19. REC. BY 926 20. DIS. BY

21. HOW REC'D.
 1. 911
 2. POLICE RADIO
 3. PHONE
 4. TTY
 5. IN PERSON
 6. ON VIEW
 7. OFF. OFF DUTY
 8. C.B. RADIO
 9. OTHER

22. TYPE OF REPORT
 1. INCIDENT
 2. ACCIDENT
 3. CITATION
 4. NONE

23. STATUS
 1. UNFOUNDED
 2. PNL
 3. OTHER
 4. CLEARED
 5. EXCEPT CLEARED

24. DATE CLEARED 10/31/99

25. OFFENSE TYPE
 1. ADULT NA
 2. JUVENILE
 3. UNKNOWN

21A. M.O.

39. (CODE S-SUSPECT W-WITNESS V-VICTIM O-OTHER)				42. ADDRESS		43. TELEPHONE
CODE	40. NAME-LAST	FIRST	MI	41. D.O.B.		
0	Ruffin Thomas	176137			St. Lawrence Ave., Beloit	

02/17/98 1320hrs Attempted registration check several ways and spelling variations. The only "HOUSE" that comes back is on a 97 Chev Trk not a match for the suspect vehicle. Unable to locate. Close at this time. M.J. Bushman

FF8888

45. IF COMPLAINANT DIFFERENT THEN CALLER, ENTER NAME, ADDRESS, D.O.B., TELEPHONE.

46. IF CODE O (OTHER) IS USED IN FIELD #39, EXPLAIN.

INCIDENT REPORT: NOTE: IF SECTION 22 ABOVE HAS NUMBER 4 CHECKED, DO NOT GO BEYOND THIS LINE WITHOUT RECORDS SECTION BEING ADVISED, OR NO RECORD ENTRIES WILL BE MADE BELOW THIS LINE.

PROPERTY VALUE	26. PROPERTY	A. CURRENCY	B. JEWELRY	C. FURS CLOTHING	D. VEHICLE (LOCAL)	E. OFFICE EQUIPMENT	F. RADIO, TV CAMERAS	G. FIREARMS	H. HOUSE-HOLD GOODS
	STOLEN	\$	\$	\$	\$	\$	\$	\$	\$
	RECOVERED	\$	\$	\$	\$	\$	\$	\$	\$
	26. PROPERTY	I. CONSUMABLES	J. LIVESTOCK	K. DRUGS	L. MARINE ITEMS	M. CONSTRUCTION ITEMS	N. LAWN AND GARDEN	O. SPORTING GOODS	P. MISC BICYCLE
	STOLEN	\$	\$	\$	\$	\$	\$	\$	\$
	RECOVERED	\$	\$	\$	\$	\$	\$	\$	\$

27. PROPERTY RECOVERED: LOCALLY ____ OTHER JURISDICTION ____ (INSERT O OR L)

PROPERTY ITEMIZATION	PROPERTY STOLEN/RECOVERED ITEMIZATION, USE THE FOLLOWING FORMAT				
	28. QUANTITY	29. ARTICLE NAME	30. BRAND NAME	31. SERIAL NUMBER	
					S R <input type="checkbox"/> <input type="checkbox"/>
					S R <input type="checkbox"/> <input type="checkbox"/>
					S R <input type="checkbox"/> <input type="checkbox"/>
					S R <input type="checkbox"/> <input type="checkbox"/>
					S R <input type="checkbox"/> <input type="checkbox"/>

33. PROPERTY DAMAGE AMOUNT \$ _____

34. INSURANCE COMPANY _____

35. OFFICER ASSAULTED Y N

36. ARSON Y N

37. STRUCTURE CODE _____

38. DAMAGE \$ _____

47. CIB ENTERED CANCELLED
 NCIC
 OTHER BROADCAST

48. TOTAL AMOUNT PROPERTY STOLEN \$ _____

49. TOTAL AMOUNT PROPERTY RECOVERED \$ _____

50. IS REPORT CONTINUED? YES NO

51. CAUTION INDICATORS, ATLS ETC.

52. DATA PROCESS INFORMATION:

COMPUTER ENTERED DATE 3/18/99
 MICROFILM INDEXED INITIAL KS

53. FILE APPROVAL

IS CASE CLASSIFICATION CORRECT?
 IF N HAS CORRECTION BEEN MADE? N

BY RR DATE 03/08/99

621-24-00248

5. INCIDENT LOCATION
Forest Junction

6. NAME LAST-FIRST-MI
[REDACTED]

7. D.O.B.
[REDACTED]

8. ADDRESS
[REDACTED]

9. TX-HOME
[REDACTED]

10. TX-BUSINESS
[REDACTED]

11. CITY STATE ZIP
[REDACTED]

12. DETAILS
Rpts he is a salesman and while driving his route observed a late 80's Chevrolet truck or Suburban with front end damage to grill headlight and bumper. Vehicle was in a

2-3-99 211

14. REC'D	15. DISP	16. 10-23	17. 10-24
13. DAY			
SUN 1	THU 5		
MON 2	FRI 6		
TUE 3	SAT 7		
WED 4			

Hermann

4218
929

19. REC. BY
928

20. DIS. BY

21. HOW REC'D.
1. 911
2. POLICE RADIO
3. PHONE
4. TTY
5. IN PERSON
6. ON VIEW
7. OFF. OFF DUTY
8. C.B. RADIO
9. OTHER

22. TYPE OF REPORT
1. INCIDENT
2. ACCIDENT
3. CITATION
4. NONE

23. STATUS
1. UNFOUNDED
2. PNL
3. OTHER
4. CLEARED
5. EXCEPT CLEARED

24. DATE CLEARED
03/08/99

25. OFFENSE TYPE
1. ADULT NA
2. JUVENILE
3. UNKNOWN

39. (CODE S-SUSPECT W-WITNESS V-VICTIM O-OTHER)				42. ADDRESS		43. TELEPHONE	
CODE	40. NAME-LAST	FIRST	MI	41. D.O.B.			
	GOSHA	AUTO BODY		176138			

garage at Gosha Auto Body in Forest Junction. Shop is located at Hwy 114 and 10.

02/16/99 1755hrs Contact by phone made with Andy Gosha owner/operator of Gosha Repair Shop. When asked about repair of vehicle described on the complaint he stated: "I only did one car this month, I have a shop full of tractors, I work on farm machinery." When described in more detail the specific vehicle he stated, "Well I did one truck an 87 Chev with hood and headlamp anf grille damage for a farmer who hit his Huebner forage box on his yard. I know he hit the bax caus I had to fix that too. The truck had red Huebner paint all over the side of it." Close out. M.J. Bushman

45. IF COMPLAINANT DIFFERENT THEN CALLER, ENTER NAME, ADDRESS, D.O.B., TELEPHONE.

46. IF CODE O (OTHER) IS USED IN FIELD #39, EXPLAIN.

INCIDENT REPORT: NOTE: IF SECTION 22 ABOVE HAS NUMBER 4 CHECKED, DO NOT GO BEYOND THIS LINE WITHOUT RECORDS SECTION BEING ADVISED, OR NO RECORD ENTRIES WILL BE MADE BELOW THIS LINE.

P R O P E R T Y V A L U E	26. PROPERTY	A. CURRENCY	B. JEWELRY	C. FURS CLOTHING	D. VEHICLE (LOCAL)	E. OFFICE EQUIPMENT	F. RADIO, TV CAMERAS	G. FIREARMS	H. HOUSE-HOLD GOODS
	STOLEN	\$	\$	\$	\$	\$	\$	\$	\$
	RECOVERED	\$	\$	\$	\$	\$	\$	\$	\$
	26. PROPERTY	I. CONSUM-ABLES	J. LIVESTOCK	K. DRUGS	L. MARINE ITEMS	M. CONSTRUCTION ITEMS	N. LAWN AND GARDEN	O. SPORTING GOODS	P. MISC BICYCLE
	STOLEN	\$	\$	\$	\$	\$	\$	\$	\$
	RECOVERED	\$	\$	\$	\$	\$	\$	\$	\$

27. PROPERTY RECOVERED: LOCALLY _____ OTHER JURISDICTION _____ (INSERT O OR L)

P R O P E R T Y I T E M I Z A T I O N	PROPERTY STOLEN/RECOVERED ITEMIZATION, USE THE FOLLOWING FORMAT				
	28. QUANTITY	29. ARTICLE NAME	30. BRAND NAME	31. SERIAL NUMBER	32. CODE
					S R <input type="checkbox"/> <input type="checkbox"/>
					S R <input type="checkbox"/> <input type="checkbox"/>
					S R <input type="checkbox"/> <input type="checkbox"/>
					S R <input type="checkbox"/> <input type="checkbox"/>
					S R <input type="checkbox"/> <input type="checkbox"/>

33. PROPERTY DAMAGE AMOUNT \$ _____

34. INSURANCE COMPANY _____

35. OFFICER ASSAULTED Y N 36. ARSON Y N 37. STRUCTURE CODE _____ 38. DAMAGE \$ _____

47. CIB ENTERED CANCELLED
 NCIC
 OTHER BROADCAST

48. TOTAL AMOUNT PROPERTY STOLEN \$ _____

49. TOTAL AMOUNT PROPERTY RECOVERED \$ _____

50. IS REPORT CONTINUED? YES NO

51. CAUTION INDICATORS, ATLS ETC.

52. DATA PROCESS INFORMATION:

COMPUTER ENTERED DATE 3/8/99
 MICROFILM INDEXED INITIAL KS

IS CASE CLASSIFICATION CORRECT? Y N
 IF N HAS CORRECTION BEEN MADE? Y N

53. FILE APPROVAL

BY RP DATE 03/08/99

1. CASE # S99 No 01038 | 2. CLASSIFICATION 6310.11 | 3. CENSUS 5240.00

4. INCIDENT CS / S99-00242

5. INCIDENT LOCATION [REDACTED]

6. ST-FIRST-MI [REDACTED] 17699 | 7. D.O.B. [REDACTED]

8. ADDRESS [REDACTED] | 9. TX-HOME [REDACTED]

11. CITY [REDACTED] STATE [REDACTED] ZIP [REDACTED] | 10. TX-BUSINESS [REDACTED]

12. DETAILS
 RECEIVED A 911 CALL FROM [REDACTED] WHO WAS IN HIS OFFICE WITH HIS SCANNER ON, AND HE PICKED UP A CELL CALL WITH [REDACTED]

99
 FR 3
 2230
 REC'D 14. 15. 16. 17.
 DISP 10-23 10-24
 13. DAY
 SUN 1 THU 5
 MON 2 FRI 6
 TUE 3 SAT 7
 WED 4

MANITOWOC COUNTY SHERIFF
 INCIDENT CARD

18. ASSIGNED
 HERRMANN 428
 929
 432

19. REC. BY 936 | 20. DIS. BY
 22. TYPE OF REPORT
 1. INCIDENT
 2. ACCIDENT
 3. CITATION
 4. NONE
 23. STATUS
 1. UNFOUNDED
 2. PNL
 3. OTHER
 4. CLEARED
 5. EXCEPT CLEARED
 24. DATE CLEARED 02/16/99
 25. OFFENSE TYPE
 1. ADULT NA
 2. JUVENILE
 3. UNKNOWN

39. (CODE S-SUSPECT W-WITNESS V-VICTIM O-OTHER)				42. ADDRESS		43. TELEPHONE
CODE	40. NAME-LAST	FIRST	MI	41. D.O.B.		

two females talking about the H&R Accident. [REDACTED] put the phone by his scanner and I could hear what the girls were saying. They talked about the truck being in the river and a subject they called B.J. as being the person who told them. They also brought up names like Tafa, Pat, Shawn or Shaun also 3 T's. They talked about a Lisa Kuklinski who was killed also a John who was also killed. They hung up at 2302Hrs. They talked about calling each back on Fri. between 1600-1700Hrs. [REDACTED] stated that he would attempt to pick up the conversation if possible. The conversation that was on the 911 started at 2230Hrs. and ended at 2302Hrs. 936/RH

A note was left for Kay to make a tape of the call. MTPD 026, Mike Stone, was dispatched to [REDACTED] to also listen to the conversation. 936/RH

See incident S99-00242. Information regarding this incident starts on page 51 of that incident. ALColborn /bjc

45. IF COMPLAINANT DIFFERENT THEN CALLER, ENTER NAME, ADDRESS, D.O.B., TELEPHONE.

46. IF CODE O (OTHER) IS USED IN FIELD #39, EXPLAIN.

INCIDENT REPORT: NOTE: IF SECTION 22 ABOVE HAS NUMBER 4 CHECKED, DO NOT GO BEYOND THIS LINE WITHOUT RECORDS SECTION BEING ADVISED, OR NO RECORD ENTRIES WILL BE MADE BELOW THIS LINE.

PROPERTY VALUE	26. PROPERTY	A. CURRENCY	B. JEWELRY	C. FURS CLOTHING	D. VEHICLE (LOCAL)	E. OFFICE EQUIPMENT	F. RADIO, TV CAMERAS	G. FIREARMS	H. HOUSE-HOLD GOODS
	STOLEN	\$	\$	\$	\$	\$	\$	\$	\$
	RECOVERED	\$	\$	\$	\$	\$	\$	\$	\$
	26. PROPERTY	I. CONSUMABLES	J. LIVESTOCK	K. DRUGS	L. MARINE ITEMS	M. CONSTRUCTION ITEMS	N. LAWN AND GARDEN	O. SPORTING GOODS	P. MISC BICYCLE
STOLEN	\$	\$	\$	\$	\$	\$	\$	\$	
RECOVERED	\$	\$	\$	\$	\$	\$	\$	\$	

27. PROPERTY RECOVERED: LOCALLY _____ OTHER JURISDICTION _____ (INSERT O OR L)

PROPERTY ITEMIZATION	PROPERTY STOLEN/RECOVERED ITEMIZATION, USE THE FOLLOWING FORMAT				
	28. QUANTITY	29. ARTICLE NAME	30. BRAND NAME	31. SERIAL NUMBER	32. CODE
					S R <input type="checkbox"/> <input type="checkbox"/>
					S R <input type="checkbox"/> <input type="checkbox"/>
					S R <input type="checkbox"/> <input type="checkbox"/>
					S R <input type="checkbox"/> <input type="checkbox"/>

33. PROPERTY DAMAGE AMOUNT \$ _____

34. INSURANCE COMPANY _____

35. OFFICER ASSAULTED Y N

36. ARSON Y N

37. STRUCTURE CODE _____

38. DAMAGE \$ _____

47. CIB ENTERED CANCELLED
 NCIC
 OTHER BROADCAST

48. TOTAL AMOUNT PROPERTY STOLEN \$ _____

49. TOTAL AMOUNT PROPERTY RECOVERED \$ _____

50. IS REPORT CONTINUED? YES NO

51. CAUTION INDICATORS, ATLS ETC.

52. DATA PROCESS INFORMATION:

COMPUTER ENTERED DATE 3.5.99
 MICROFILM INDEXED INITIAL AS

53. FILE APPROVAL

IS CASE CLASSIFICATION CORRECT?
 IF N HAS CORRECTION BEEN MADE? N

BY [Signature] DATE 02/16/99

INCIDENT # 05/899-00242

5- INCIDENT LOCATION
ARNOLD/HICKORY FONDULAC

6. NAME- LAST-FIRST-MI
ANON. (2)

7. D.O.B.

8. ADDRESS

9. TX-HOME

11. CITY STATE ZIP

10. TX-BUSINESS

7560 6617070

10. ASSIGNED

MTSO-CS, 929
BUSHMAN 4411

19. REC. BY **945** 20. DIS. BY **-**

22. TYPE OF REPORT
 1. INCIDENT
 2. ACCIDENT
 3. CITATION
 4. NONE

21. HOW REC'D.
 1. 911
 2. POLICE RADIO
 3. PHONE
 4. TTY
 5. IN PERSON
 6. ON VIEW
 7. OFF. OFF DUTY
 8. C.B. RADIO
 9. OTHER **CS**

23. STATUS
 1. UNFOUNDED
 2. PNL
 3. OTHER
 4. CLEARED
 5. EXCEPT CLEARED

24. DATE CLEARED **03/08/99**

25. OFFENSE TYPE
 1. ADULT NA
 2. JUVENILE
 3. UNKNOWN

14. REC'D

15. DISP

16. 10-23

17. 10-24

13. DAY
 SUN 1 **THU 5**
 MON 2 FRI 6
 TUE 3 SAT 7
 WED 4

12. DETAILS
States she saw a late model ('89 or so) Chev truck @ Commercial Radiator in Fond Du Lac this AM. (R) front end damage. no plate #

39. (CODE S-SUSPECT W-WITNESS V-VICTIM O-OTHER)				41. D.O.B.		42. ADDRESS		43. TELEPHONE	
CODE	40. NAME-LAST	FIRST	MI						
	SUMMERFELD	BARBARA				FOND DULAC			

02/16/99 1620hrs Spoke with Jim Treptow Service manager. He checked his records and found the service referred to above on 02/04/99. He stated the owner of that vehicle is a regular customer and he knows the truck well. It is a Blk.89 Chev.P/U new style. There was damage and stated he could get the plate number if we needed it. I advised him with his description it was obvious this was not the vehicle. Description of suspect vehicle was given and contact number should suspicious vehicle show up. Cloce out. M.J. Bushman

02/16/99 1715hrs Call recieved from Jim Treptow stated he had a second vehicle around that period of time an 85 Chev p/u blk. He stated this vehicle sat without a transmission for four weeks though. Treptow is on a circuit with 18 other repair shops in Fond Du Lac and all have been notified just prior to him calling back. M.J. Bushman

45. IF COMPLAINANT DIFFERENT THEN CALLER, ENTER NAME, ADDRESS, D.O.B., TELEPHONE.

46. IF CODE O (OTHER) IS USED IN FIELD #39, EXPLAIN.

INCIDENT REPORT: NOTE: IF SECTION 22 ABOVE HAS NUMBER 4 CHECKED, DO NOT GO BEYOND THIS LINE WITHOUT RECORDS SECTION BEING ADVISED, OR NO RECORD ENTRIES WILL BE MADE BELOW THIS LINE.

PROPERTY VALUE	26. PROPERTY	A. CURRENCY	B. JEWELRY	C. FURS CLOTHING	D. VEHICLE (LOCAL)	E. OFFICE EQUIPMENT	F. RADIO, TV CAMERAS	G. FIREARMS	H. HOUSE-HOLD GOODS
	STOLEN	\$	\$	\$	\$	\$	\$	\$	\$
	RECOVERED	\$	\$	\$	\$	\$	\$	\$	\$
	26. PROPERTY	I. CONSUM-ABLES	J. LIVESTOCK	K. DRUGS	L. MARINE ITEMS	M. CONSTRUCTION ITEMS	N. LAWN AND GARDEN	O. SPORTING GOODS	P. MISC BICYCLE
	STOLEN	\$	\$	\$	\$	\$	\$	\$	\$
	RECOVERED	\$	\$	\$	\$	\$	\$	\$	\$

27. PROPERTY RECOVERED: LOCALLY _____ OTHER JURISDICTION _____ (INSERT O OR L)

PROPERTY ITEMIZATION	PROPERTY STOLEN/RECOVERED ITEMIZATION, USE THE FOLLOWING FORMAT				
	28. QUANTITY	29. ARTICLE NAME	30. BRAND NAME	31. SERIAL NUMBER	32. CODE
					S R <input type="checkbox"/> <input type="checkbox"/>
					S R <input type="checkbox"/> <input type="checkbox"/>
					S R <input type="checkbox"/> <input type="checkbox"/>
					S R <input type="checkbox"/> <input type="checkbox"/>

33. PROPERTY DAMAGE AMOUNT \$ _____

34. INSURANCE COMPANY _____

35. OFFICER ASSAULTED Y N

36. ARSON Y N

37. STRUCTURE CODE _____

38. DAMAGE \$ _____

47. CIB ENTERED CANCELLED
 NCIC
 OTHER BROADCAST

48. TOTAL AMOUNT PROPERTY STOLEN \$ _____

49. TOTAL AMOUNT PROPERTY RECOVERED \$ _____

50. IS REPORT CONTINUED? YES NO

51. CAUTION INDICATORS, ATLS ETC.

52. DATA PROCESS INFORMATION:

COMPUTER ENTERED DATE 3.8.99
 MICROFILM INDEXED INITIAL KS

53. FILE APPROVAL

IS CASE CLASSIFICATION CORRECT? N
 IF N HAS CORRECTION BEEN MADE? N

BY KP DATE 03.28.99

S99 No 01052 | 571181 | 341000

4. INCIDENT
SUSP VEH. / 599-00242

5. INCIDENT LOCATION
Auto Maribel ([REDACTED]) MARIBEL (RB)

6. NAME LAST-FIRST-MI
[REDACTED] ANONYMOUS

7. D.O.B.

8. ADDRESS

9. TX-HOME

10. TX-BUSINESS

11. CITY STATE ZIP

12. DETAILS
REQ. OFFICER CK. VEH. MATCH-
ING DESCRIPTION OF SUSP. VEH. IN
FATAL H+R.

1010
1010
020499
020499

INCIDENT CARD

18. ASSIGNED
BONFIGT 450
929

19. REC. BY
923

20. DIS. BY
923

21. HOW REC'D.
1. 911
2. POLICE RADIO
3. PHONE
4. TTY
5. IN PERSON
6. ON VIEW
7. OFF. OFF DUTY
8. C.B. RADIO
9. OTHER
21A. M.O.

22. TYPE OF REPORT
1. INCIDENT
2. ACCIDENT
3. CITATION
4. NONE

23. STATUS
1. UNFOUNDED
2. PNL
3. OTHER
4. CLEARED
5. EXCEPT CLEARED

24. DATE CLEARED
1030899

25. OFFENSE TYPE
1. ADULT NA
2. JUVENILE
3. UNKNOWN

39. (CODE S-SUSPECT W-WITNESS V-VICTIM O-OTHER)	40. NAME-LAST	FIRST	MI	41. D.O.B.	42. ADDRESS	43. TELEPHONE
O	ANDREWS	49318	AIMEE	J	[REDACTED] 34th St. Two Rivers	
O	ANDREWS	13829	JAY	A	[REDACTED] 34th St. Two Rivers	
O	PEROUTKA	85135	MICHAEL	T	[REDACTED] Peaceful Ln. Manitowoc	[REDACTED]

02/04/99: I, Deputy Bonfigt, received information to check a vehicle which was brought to R&B AUTO in Maribel which had left front damage. The damage was left front quarter panel, grill, and windshield. I was given a VIN of [REDACTED]. Running this VIN, it came back to AIMEE ANDREWS of [REDACTED] 34th St, Two Rivers.

02/05/99: I made contact at the ANDREWS residence where I spoke with AIMEE. AIMEE stated her husband, JAY ANDREWS, had the vehicle at HAMILTON'S where he works. AIMEE also stated they purchased this vehicle on Monday, 02/01/99, from MICHAEL PEROUTKA.

I proceeded to go to HAMILTON'S to check this vehicle. Once there, I was met by JAY who stated he did buy the vehicle on 02/01/99 from MICHAEL PEROUTKA and that he reported a car-deer accident over the weekend. An in-house check revealed there was a car-deer accident reported by MICHAEL on 01/31/99. JAY also stated to me that officers did stop out by MICHAEL'S house on 2 other occasions to check the vehicle.

This would not be the suspect vehicle from the fatal hit and run.

Running a 28 check on the VIN, the RP is WI truck AJ59298. It is a 1986 Chevy registered to AIMEE ANDREWS. The color of the truck is light blue over dark blue.
AJBonfigt ASB/bjc

97

45. IF COMPLAINANT DIFFERENT THEN CALLER, ENTER NAME, ADDRESS, D.O.B., TELEPHONE.

46. IF CODE O (OTHER) IS USED IN FIELD #39, EXPLAIN.

INCIDENT REPORT: NOTE: IF SECTION 22 ABOVE HAS NUMBER 4 CHECKED, DO NOT GO BEYOND THIS LINE WITHOUT RECORDS SECTION BEING ADVISED, OR NO RECORD ENTRIES WILL BE MADE BELOW THIS LINE.

PROPERTY VALUE	26. PROPERTY	A. CURRENCY	B. JEWELRY	C. FURS CLOTHING	D. VEHICLE (LOCAL)	E. OFFICE EQUIPMENT	F. RADIO, TV CAMERAS	G. FIREARMS	H. HOUSE-HOLD GOODS
	STOLEN	\$	\$	\$	\$	\$	\$	\$	\$
	RECOVERED	\$	\$	\$	\$	\$	\$	\$	\$
	26. PROPERTY	I. CONSUM-ABLES	J. LIVESTOCK	K. DRUGS	L. MARINE ITEMS	M. CONSTRUCTION ITEMS	N. LAWN AND GARDEN	O. SPORTING GOODS	P. MISC BICYCLE
STOLEN	\$	\$	\$	\$	\$	\$	\$	\$	
RECOVERED	\$	\$	\$	\$	\$	\$	\$	\$	

27. PROPERTY RECOVERED: LOCALLY _____ OTHER JURISDICTION _____ (INSERT O OR L)

PROPERTY ITEMIZATION	PROPERTY STOLEN/RECOVERED ITEMIZATION, USE THE FOLLOWING FORMAT				
	28. QUANTITY	29. ARTICLE NAME	30. BRAND NAME	31. SERIAL NUMBER	
					S <input type="checkbox"/> R <input type="checkbox"/>
					S <input type="checkbox"/> R <input type="checkbox"/>
					S <input type="checkbox"/> R <input type="checkbox"/>
					S <input type="checkbox"/> R <input type="checkbox"/>

33. PROPERTY DAMAGE AMOUNT \$ _____

34. INSURANCE COMPANY _____

35. OFFICER ASSAULTED Y N

36. ARSON Y N

37. STRUCTURE CODE _____ 38. DAMAGE \$ _____

47. CIB ENTERED CANCELLED
 NCIC
 OTHER BROADCAST

48. TOTAL AMOUNT PROPERTY STOLEN \$ _____

49. TOTAL AMOUNT PROPERTY RECOVERED \$ _____

50. IS REPORT CONTINUED? YES NO

51. CAUTION INDICATORS, ATLS ETC.

52. DATA PROCESS INFORMATION:

COMPUTER ENTERED DATE 13.8.99
 MICROFILM INDEXED INITIAL KS

53. FILE APPROVAL

IS CASE CLASSIFICATION CORRECT?
 IF N HAS CORRECTION BEEN MADE? N

BY R DATE 03 08 99

4. INCIDENT

CS/599-00242

INCIDENT LOCATION

Silver Ck Rd. & Hwy CR

6. NAME- LAST-FIRST-MI

45130

7. D.O.B.

8. ADDRESS

9. TX-HOME

11. CITY

STATE

ZIP

10. TX-BUSINESS

12. DETAILS

Caller states approx 1-2 weeks after the accident he observed a dark colored blazer or Jimmy, newer

14. REC'D

15. DISP

16. 10-23

17. 10-24

13. DAY

SUN 1 THU 5
MON 2 FRI 6
TUE 3 SAT 7
WED 4

18. ASSIGNED

Sats Leak
BUSHMAN

204
HHT
929

19. REC. BY

925

20. DIS. BY

21. HOW REC'D.

- 1. 911
- 2. POLICE RADIO
- 3. PHONE
- 4. TTY
- 5. IN PERSON
- 6. ON VIEW
- 7. OFF. OFF DUTY
- 8. C.B. RADIO
- 9. OTHER

22. TYPE OF REPORT

- 1. INCIDENT
- 2. ACCIDENT
- 3. CITATION
- 4. NONE

23. STATUS

- 1. UNFOUNDED
- 2. PNL
- 3. OTHER
- 4. CLEARED
- 5. EXCEPT CLEARED

24. DATE CLEARED

03/08/99

21A. M.O.

25. OFFENSE TYPE

- 1. ADULT NA
- 2. JUVENILE
- 3. UNKNOWN

39. (CODE S-SUSPECT W-WITNESS V-VICTIM O-OTHER)

CODE	40. NAME-LAST	FIRST	MI	41. D.O.B.	42. ADDRESS	43. TELEPHONE

model with grill damage on 18th Street, north of Waldo, northbound. Vehicle had a personalized plate beginning with "R-----" and had 5-6 letters total. The word on the plate appeared to be a nick name or last name. There was also damage to the passenger side of the vehicle. Caller states a 'lift kit' made the vehicle higher than normal, the tires appeared larger than normal with newer, more expensive rims. The front bumper was intact, vehicle had square headlights. The female operator appeared to be in her thirties, with curly, longer brown hair. SESS

02/16/99 Not enough information to followup at this time. Description does not appear to be suspect vehicle-higher than normal and large tires. Close out M.J. Bushman

999230

27

45. IF COMPLAINANT DIFFERENT THEN CALLER, ENTER NAME, ADDRESS, D.O.B., TELEPHONE.

46. IF CODE O (OTHER) IS USED IN FIELD #39, EXPLAIN.

INCIDENT REPORT: NOTE: IF SECTION 22 ABOVE HAS NUMBER 4 CHECKED, DO NOT GO BEYOND THIS LINE WITHOUT RECORDS SECTION BEING ADVISED, OR NO RECORD ENTRIES WILL BE MADE BELOW THIS LINE.

PROPERTY VALUE	26. PROPERTY	A. CURRENCY	B. JEWELRY	C. FURS CLOTHING	D. VEHICLE (LOCAL)	E. OFFICE EQUIPMENT	F. RADIO, TV CAMERAS	G. FIREARMS	H. HOUSE-HOLD GOODS
	STOLEN	\$	\$	\$	\$	\$	\$	\$	\$
	RECOVERED	\$	\$	\$	\$	\$	\$	\$	\$
	26. PROPERTY	I. CONSUMABLES	J. LIVESTOCK	K. DRUGS	L. MARINE ITEMS	M. CONSTRUCTION ITEMS	N. LAWN AND GARDEN	O. SPORTING GOODS	P. MISC BICYCLE
	STOLEN	\$	\$	\$	\$	\$	\$	\$	\$
	RECOVERED	\$	\$	\$	\$	\$	\$	\$	\$

27. PROPERTY RECOVERED: LOCALLY _____ OTHER JURISDICTION _____ (INSERT O OR L)

PROPERTY ITEMIZATION	PROPERTY STOLEN/RECOVERED ITEMIZATION, USE THE FOLLOWING FORMAT				32. CODE S R <input type="checkbox"/> <input type="checkbox"/>	
	28. QUANTITY	29. ARTICLE NAME	30. BRAND NAME	31. SERIAL NUMBER		

33. PROPERTY DAMAGE AMOUNT \$ _____ 34. INSURANCE COMPANY _____

35. OFFICER ASSAULTED Y N 36. ARSON Y N 37. STRUCTURE CODE _____ 38. DAMAGE \$ _____

47. CIB	ENTERED <input type="checkbox"/>	CANCELLED <input type="checkbox"/>	48. TOTAL AMOUNT PROPERTY STOLEN \$ _____
NCIC	<input type="checkbox"/>	<input type="checkbox"/>	
OTHER BROADCAST	<input type="checkbox"/>	<input type="checkbox"/>	
			49. TOTAL AMOUNT PROPERTY RECOVERED \$ _____

50. IS REPORT CONTINUED? YES NO 51. CAUTION INDICATORS, ATLS ETC.

52. DATA PROCESS INFORMATION:

COMPUTER ENTERED DATE 3.8.99

MICROFILM INDEXED INITIAL KS

IS CASE CLASSIFICATION CORRECT? IF N HAS CORRECTION BEEN MADE? Y N

53. FILE APPROVAL
BY KS DATE 03.08.99

MCSD 028 1/91

1. CASE # S99 No. 01068 2. CLASSIFICATION 630.11 3. CENSUS 1,40000

4. INCIDENT CS / S99-00242

5. INCIDENT LOCATION Silver Crk Rd. & Hwy CR

6. NAME LAST FIRST MI [REDACTED] 7. D.O.B. [REDACTED]

8. ADDRESS [REDACTED] 9. TX-HOME [REDACTED]

11. CITY [REDACTED] STATE [REDACTED] ZIP [REDACTED] 10. TX-BUSINESS [REDACTED]

12. DETAILS At approx. 0930 hrs - today caller saw a ivory colored pick-up truck, possibly mid-90's

1814
02/04/99
14. REC'D
15. DISP
16. 10-23
17. 10-24
13. DAY
SUN 1 THU 5
MON 2 FRI 6
TUE 3 SAT 7
WED 4

MANITOWOC COUNTY SHERIFF INCIDENT CARD

18. ASSIGNED Sgt. Leak 204
929
441

19. REC. BY 925 20. DIS. BY
21. HOW REC'D.
1. 911
2. POLICE RADIO
3. PHONE
4. TTY
5. IN PERSON
6. ON VIEW
7. OFF. OFF DUTY
8. C.B. RADIO
9. OTHER
21A. M.O.
22. TYPE OF REPORT
1. INCIDENT
2. ACCIDENT
3. CITATION
4. NONE
23. STATUS
1. UNFOUNDED
2. PNL
3. OTHER
4. CLEARED
5. EXCEPT CLEARED
24. DATE CLEARED 03/08/99
25. OFFENSE TYPE
1. ADULT NA
2. JUVENILE
3. UNKNOWN

39. (CODE S-SUSPECT W-WITNESS V-VICTIM O-OTHER)				41. D.O.B.	42. ADDRESS	43. TELEPHONE
CODE	40. NAME-LAST	FIRST	MI			

model, turn southbound onto Hwy 49 from Hwy 10. Vehicle had darker colored stripes on the side, with possible plate of PS36934, and grill damage on the passenger side, round headlights, caller described the grill as wider and thicker than normal. SESE
02/04/99 Unable to locate, Close out. M.J. Bushman
MJB

PP 83 23

94

45. IF COMPLAINANT DIFFERENT THEN CALLER, ENTER NAME, ADDRESS, D.O.B., TELEPHONE.

46. IF CODE O (OTHER) IS USED IN FIELD #39, EXPLAIN.

INCIDENT REPORT: NOTE: IF SECTION 22 ABOVE HAS NUMBER 4 CHECKED, DO NOT GO BEYOND THIS LINE WITHOUT RECORDS SECTION BEING ADVISED, OR NO RECORD ENTRIES WILL BE MADE BELOW THIS LINE.

PROPERTY VALUE	26. PROPERTY	A. CURRENCY	B. JEWELRY	C. FURS CLOTHING	D. VEHICLE (LOCAL)	E. OFFICE EQUIPMENT	F. RADIO, TV CAMERAS	G. FIREARMS	H. HOUSEHOLD GOODS
	STOLEN	\$	\$	\$	\$	\$	\$	\$	\$
	RECOVERED	\$	\$	\$	\$	\$	\$	\$	\$
	26. PROPERTY	I. CONSUMABLES	J. LIVESTOCK	K. DRUGS	L. MARINE ITEMS	M. CONSTRUCTION ITEMS	N. LAWN AND GARDEN	O. SPORTING GOODS	P. MISC BICYCLE
	STOLEN	\$	\$	\$	\$	\$	\$	\$	\$
	RECOVERED	\$	\$	\$	\$	\$	\$	\$	\$

27. PROPERTY RECOVERED: LOCALLY _____ OTHER JURISDICTION _____ (INSERT O OR L)

PROPERTY ITEMIZATION	PROPERTY STOLEN/RECOVERED ITEMIZATION, USE THE FOLLOWING FORMAT				
	28. QUANTITY	29. ARTICLE NAME	30. BRAND NAME	31. SERIAL NUMBER	
					S R <input type="checkbox"/> <input type="checkbox"/>
					S R <input type="checkbox"/> <input type="checkbox"/>
					S R <input type="checkbox"/> <input type="checkbox"/>
					S R <input type="checkbox"/> <input type="checkbox"/>
					S R <input type="checkbox"/> <input type="checkbox"/>

33. PROPERTY DAMAGE AMOUNT \$ _____ 34. INSURANCE COMPANY _____

35. OFFICER ASSAULTED Y N 36. ARSON Y N 37. STRUCTURE CODE _____ 38. DAMAGE \$ _____

47. CIB ENTERED CANCELLED
 NCIC
 OTHER BROADCAST

48. TOTAL AMOUNT PROPERTY STOLEN \$ _____

49. TOTAL AMOUNT PROPERTY RECOVERED \$ _____

50. IS REPORT CONTINUED? YES NO

51. CAUTION INDICATORS, ATLS ETC.

52. DATA PROCESS INFORMATION:

COMPUTER ENTERED DATE 3/8/99
 MICROFILM INDEXED INITIAL [Signature]

53. FILE APPROVAL

BY [Signature] DATE 03/08/99

IS CASE CLASSIFICATION CORRECT? Y N
 IF N HAS CORRECTION BEEN MADE? Y N

1. CASE # 99 No 01080	2. CLASSIFICATION 6,310,11	3. CENSUS 5,210,00
4. INCIDENT S See 599-00242		
5. INCIDENT LOCATION		
6. NAME- LAST - FIRST - MI [REDACTED] (35401)	7. D.O.B.	
8. ADDRESS		9. TX-HOME
11. CITY	STATE	ZIP
10. TX-BUSINESS		
12. DETAILS COMPL. PHONED ON CRIMESTOPPER LINE W/ INFO. INCLUDED ON ATTACHED FORM.		

02-05-99
1110

MANITOWOC COUNTY SHERIFF INCIDENT CARD		
18. ASSIGNED Bushman H.H.I.		
MTSO		91219
19. REC. BY 930	20. DIS. BY 930	22. TYPE OF REPORT ① INCIDENT 2. ACCIDENT 3. CITATION 4. NONE
21. HOW REC'D. 1. 911 2. POLICE RADIO 3. PHONE CS 4. TTY 5. IN PERSON 6. ON VIEW 7. OFF. OFF DUTY 8. C.B. RADIO 9. OTHER		23. STATUS 1. UNFOUNDED 2. PNL 3. OTHER 4. CLEARED 5. EXCEPT CLEARED
13. DAY SUN 1 THU 5 MON 2 FR 6 TUE 3 SAT 7 WED 4		24. DATE CLEARED 103108199
21A. M.O.		25. OFFENSE TYPE 1. ADULT <input type="checkbox"/> NA <input checked="" type="checkbox"/> 2. JUVENILE <input type="checkbox"/> 3. UNKNOWN <input type="checkbox"/>

39. (CODE S-SUSPECT W-WITNESS V-VICTIM O-OTHER)						
CODE	40. NAME- LAST	FIRST	MI	41. D.O.B.	42. ADDRESS	43. TELEPHONE
O	PRECISION WOODCRAFTERS INC				[REDACTED] CTR, MTWC	[REDACTED]
	142225					

02/22/99 1345hrs Contact made by phone, manager in a meeting, number left for call back. MJB
 02/22/99 Contact by phone made with Keith Troska manager of Precision Woodcrafter's [REDACTED] CTR R. He returned my call and advised they do have the vehicle mentioned on the Crime Stopper's report. It is an 87 Chev C-10 van, red color. It does have minor damage to the grille estimated to be three years old approximately 6x6 inch size. Minor scratches to the painted bumper and minor dings on body. He welcomed Officers out to check it. He was not sure there was any further damage than listed as the vehicle is often loaned out to employee who has a need.
 1557hrs Off. Colborn made contact and viewed the vehicle, It is not the suspect vehicle
 Close out. M.J. Bushman *MJB*

PP 8080

11

S99 No 01080

45. IF COMPLAINANT DIFFERENT THEN CALLER, ENTER NAME, ADDRESS, D.O.B., TELEPHONE.

46. IF CODE O (OTHER) IS USED IN FIELD #39, EXPLAIN.

INCIDENT REPORT: NOTE: IF SECTION 22 ABOVE HAS NUMBER 4 CHECKED, DO NOT GO BEYOND THIS LINE WITHOUT RECORDS SECTION BEING ADVISED, OR NO RECORD ENTRIES WILL BE MADE BELOW THIS LINE.

PROPERTY VALUE	26. PROPERTY	A. CURRENCY	B. JEWELRY	C. FURS CLOTHING	D. VEHICLE (LOCAL)	E. OFFICE EQUIPMENT	F. RADIO, TV CAMERAS	G. FIREARMS	H. HOUSE-HOLD GOODS
	STOLEN	\$	\$	\$	\$	\$	\$	\$	\$
	RECOVERED	\$	\$	\$	\$	\$	\$	\$	\$
	26. PROPERTY	I. CONSUMABLES	J. LIVESTOCK	K. DRUGS	L. MARINE ITEMS	M. CONSTRUCTION ITEMS	N. LAWN AND GARDEN	O. SPORTING GOODS	P. MISC BICYCLE
	STOLEN	\$	\$	\$	\$	\$	\$	\$	\$
	RECOVERED	\$	\$	\$	\$	\$	\$	\$	\$

27. PROPERTY RECOVERED: LOCALLY _____ OTHER JURISDICTION _____ (INSERT O OR L)

PROPERTY ITEMIZATION	PROPERTY STOLEN/RECOVERED ITEMIZATION, USE THE FOLLOWING FORMAT				
	28. QUANTITY	29. ARTICLE NAME	30. BRAND NAME	31. SERIAL NUMBER	
					S <input type="checkbox"/> R <input type="checkbox"/>
					S <input type="checkbox"/> R <input type="checkbox"/>
					S <input type="checkbox"/> R <input type="checkbox"/>
					S <input type="checkbox"/> R <input type="checkbox"/>
					S <input type="checkbox"/> R <input type="checkbox"/>

33. PROPERTY DAMAGE AMOUNT \$ _____

34. INSURANCE COMPANY _____

35. OFFICER ASSAULTED Y N

36. ARSON Y N

37. STRUCTURE CODE _____

38. DAMAGE \$ _____

47. CIB ENTERED CANCELLED
 NCIC
 OTHER BROADCAST

48. TOTAL AMOUNT PROPERTY STOLEN \$ _____

49. TOTAL AMOUNT PROPERTY RECOVERED \$ _____

50. IS REPORT CONTINUED? YES NO

51. CAUTION INDICATORS, ATLS ETC.

52. DATA PROCESS INFORMATION:

COMPUTER ENTERED DATE 3.8.99
 MICROFILM INDEXED INITIAL AS

IS CASE CLASSIFICATION CORRECT? N
 IF N HAS CORRECTION BEEN MADE? N

53. FILE APPROVAL

BY KP DATE 03.08.99

1. CASE # S99 No 01085 | 2. CLASSIFICATION 6310.11 | 3. CENSUS 5,240.00

4. INCIDENT S99-00242
 5. INCIDENT LOCATION Detroit MIWE.
 6. LAST-FIRST-MI Anonymous
 7. D.O.B.
 8. ADDRESS
 9. TX-HOME
 10. TX-BUSINESS
 11. CITY STATE ZIP

12. DETAILS
 Caller states there was a CHEV. TR
 Faded blue RP BE 86686. Veh
 has grill damage outside & has
 piece of cork board in the grill area
 with a smiley face on it.

1225 020599

14. RECD	15. DISP	16. 10-23	17. 10-24
13. DAY			
SUN 1	THU 5		
MON 2	FRI 6		
TUE 3	SAT 7		
WED 4			

MANITOWOC COUNTY SHERIFF
INCIDENT CARD

18. ASSIGNED
 JOST 449
 929

19. REC. BY 20. DIS. BY
 JOST JOST

21. HOW REC'D.
 1. 911
 2. POLICE RADIO
 3. PHONE
 4. TTY
 5. IN PERSON
 6. ON VIEW
 7. OFF. OFF DUTY
 8. C.B. RADIO
 9. OTHER

22. TYPE OF REPORT
 1. INCIDENT
 2. ACCIDENT
 3. CITATION
 4. NONE

23. STATUS
 1. UNFOUNDED
 2. PNL
 3. OTHER
 4. CLEARED
 5. EXCEPT CLEARED

24. DATE CLEARED 03 08 99

25. OFFENSE TYPE
 1. ADULT NA
 2. JUVENILE
 3. UNKNOWN

21A. M.O.

39. (CODE S-SUSPECT W-WITNESS Y-VICTIM O-OTHER)	40. NAME-LAST	FIRST	MI	41. D.O.B.	42. ADDRESS	43. TELEPHONE

Above vehicle was checked on 02-10-99 by 449. Vehicle damage does not coincide with damage on suspect vehicle. Vehicle is also a different year. No damage observed to any other section of front of truck. Information was added to S9900242. [Signature]

PP 10280

CASE # S99 No 01085

45. IF COMPLAINANT DIFFERENT THEN CALLER, ENTER NAME, ADDRESS, D.O.B., TELEPHONE.

46. IF CODE O (OTHER) IS USED IN FIELD #39, EXPLAIN.

INCIDENT REPORT: NOTE: IF SECTION 22 ABOVE HAS NUMBER 4 CHECKED, DO NOT GO BEYOND THIS LINE WITHOUT RECORDS SECTION BEING ADVISED, OR NO RECORD ENTRIES WILL BE MADE BELOW THIS LINE.

PROPERTY VALUE	26. PROPERTY	A. CURRENCY	B. JEWELRY	C. FURS CLOTHING	D. VEHICLE (LOCAL)	E. OFFICE EQUIPMENT	F. RADIO, TV CAMERAS	G. FIREARMS	H. HOUSE-HOLD GOODS
	STOLEN	\$	\$	\$	\$	\$	\$	\$	\$
	RECOVERED	\$	\$	\$	\$	\$	\$	\$	\$
	26. PROPERTY	I. CONSUM-ABLES	J. LIVESTOCK	K. DRUGS	L. MARINE ITEMS	M. CONSTRUCTION ITEMS	N. LAWN AND GARDEN	O. SPORTING GOODS	P. MISC BICYCLE
	STOLEN	\$	\$	\$	\$	\$	\$	\$	\$
	RECOVERED	\$	\$	\$	\$	\$	\$	\$	\$

27. PROPERTY RECOVERED: LOCALLY _____ OTHER JURISDICTION _____ (INSERT O OR L)

PROPERTY ITEMIZATION	PROPERTY STOLEN/RECOVERED ITEMIZATION, USE THE FOLLOWING FORMAT				
	28. QUANTITY	29. ARTICLE NAME	30. BRAND NAME	31. SERIAL NUMBER	32. CODE
					S R <input type="checkbox"/> <input type="checkbox"/>
					S R <input type="checkbox"/> <input type="checkbox"/>
					S R <input type="checkbox"/> <input type="checkbox"/>
					S R <input type="checkbox"/> <input type="checkbox"/>
					S R <input type="checkbox"/> <input type="checkbox"/>

33. PROPERTY DAMAGE AMOUNT \$ _____

34. INSURANCE COMPANY _____

35. OFFICER ASSAULTED Y N

36. ARSON Y N

37. STRUCTURE CODE _____

38. DAMAGE \$ _____

47. CIB ENTERED CANCELLED
 NCIC
 OTHER BROADCAST

48. TOTAL AMOUNT PROPERTY STOLEN \$ _____

49. TOTAL AMOUNT PROPERTY RECOVERED \$ _____

50. IS REPORT CONTINUED? YES NO

51. CAUTION INDICATORS, ATLS ETC.

52. DATA PROCESS INFORMATION:

COMPUTER ENTERED DATE 13.8.99
 MICROFILM INDEXED INITIAL KS

53. FILE APPROVAL

IS CASE CLASSIFICATION CORRECT? N
 IF N HAS CORRECTION BEEN MADE? N

BY [Signature] DATE 030899

1. CASE # S99 No 01086 2. CLASSIFICATION C3011 3. CENSUS 141000

4. INCIDENT S99-00242

5. REPORT LOCATION CR + Silver Crk Rd.

6. NAME LAST-FIRST-MI [REDACTED] 7. D.O.B. [REDACTED]

8. ADDRESS [REDACTED] 9. TX-HOME [REDACTED]

11. CITY [REDACTED] STATE [REDACTED] ZIP [REDACTED] 10. TX-BUSINESS [REDACTED]

12. DETAILS At approx. noon today caller saw a white van with driver's side grill damaged parked at

1425
02/10/99
1425
14. REC'D
15. DISP
16. 10-23
17. 10-24
13. DAY
SUN 1 THU 5
MON 2 FRI 6
TUE 3 SAT 7
WED 4

MANITOWOC COUNTY SHERIFF
INCIDENT CARD

18. ASSIGNED Det. Lent 204
929

19. REC. BY PDS 20. DIS. BY [REDACTED]

21. HOW REC'D.
1. 911
2. POLICE RADIO
3. PHONE
4. TTY
5. IN PERSON
6. ON VIEW
7. OFF. OFF DUTY
8. C.B. RADIO
9. OTHER

22. TYPE OF REPORT
1. INCIDENT
2. ACCIDENT
3. CITATION
4. NONE

23. STATUS
1. UNFOUNDED
2. PNL
3. OTHER
4. CLEARED
5. EXCEPT CLEARED

24. DATE CLEARED 03/08/99

25. OFFENSE TYPE
1. ADULT NA
2. JUVENILE
3. UNKNOWN

39. (CODE: S-SUSPECT W-WITNESS V-VICTIM O-OTHER)				41. D.O.B.		42. ADDRESS		43. TELEPHONE	
CODE	40. NAME-LAST	FIRST	MI						
	AMA	PLUMBING				GREEN BAY		[REDACTED]	
		176237							

McDonald's in DePere. The van was a Chev product, model could have been anywhere in the 1980's or '90s. There was no rust or primer. "AMA" was written on the van in red letters, and "Heating, Air Conditioning, and Reprigeration" in black letters. No license plate number obtained. The driver is described as a male in his 30's or 40's, thin build, with reddish-brown hair. SESE

02/16/99 1745hrs Contact made with AMA Plumbing manager Dale Besson. He stated the van in question is a 92 Chev usually driven by a Jeff Walschinske an employee. Jeff struck a deer in Brown County and an accident report should be on file there. AMA has not had the vehicle repaired at this time. Not the vehicle we're looking for, close. M.J. Bushman

PP 9 63

24

S99 01086

45. IF COMPLAINANT DIFFERENT THEN CALLER, ENTER NAME, ADDRESS, D.O.B., TELEPHONE.

46. IF CODE O (OTHER) IS USED IN FIELD #39, EXPLAIN.

INCIDENT REPORT: NOTE: IF SECTION 22 ABOVE HAS NUMBER 4 CHECKED, DO NOT GO BEYOND THIS LINE WITHOUT RECORDS SECTION BEING ADVISED, OR NO RECORD ENTRIES WILL BE MADE BELOW THIS LINE.

PROPERTY VALUE	26. PROPERTY	A. CURRENCY	B. JEWELRY	C. FURS CLOTHING	D. VEHICLE (LOCAL)	E. OFFICE EQUIPMENT	F. RADIO, TV CAMERAS	G. FIREARMS	H. HOUSE-HOLD GOODS
	STOLEN	\$	\$	\$	\$	\$	\$	\$	\$
	RECOVERED	\$	\$	\$	\$	\$	\$	\$	\$
	26. PROPERTY	I. CONSUMABLES	J. LIVESTOCK	K. DRUGS	L. MARINE ITEMS	M. CONSTRUCTION ITEMS	N. LAWN AND GARDEN	O. SPORTING GOODS	P. MISC BICYCLE
	STOLEN	\$	\$	\$	\$	\$	\$	\$	\$
	RECOVERED	\$	\$	\$	\$	\$	\$	\$	\$

27. PROPERTY RECOVERED: LOCALLY _____ OTHER JURISDICTION _____ (INSERT O OR L)

PROPERTY ITEMIZATION	PROPERTY STOLEN/RECOVERED ITEMIZATION, USE THE FOLLOWING FORMAT				
	28. QUANTITY	29. ARTICLE NAME	30. BRAND NAME	31. SERIAL NUMBER	32. CODE
					S <input type="checkbox"/> R <input type="checkbox"/>
					S <input type="checkbox"/> R <input type="checkbox"/>
					S <input type="checkbox"/> R <input type="checkbox"/>
					S <input type="checkbox"/> R <input type="checkbox"/>
					S <input type="checkbox"/> R <input type="checkbox"/>

33. PROPERTY DAMAGE AMOUNT \$ _____ 34. INSURANCE COMPANY _____

35. OFFICER ASSAULTED Y N 36. ARSON Y N 37. STRUCTURE CODE _____ 38. DAMAGE \$ _____

47. CIB NCIC OTHER BROADCAST	ENTERED	CANCELLED	48. TOTAL AMOUNT PROPERTY STOLEN \$ _____
	<input type="checkbox"/>	<input type="checkbox"/>	
	<input type="checkbox"/>	<input type="checkbox"/>	
			49. TOTAL AMOUNT PROPERTY RECOVERED \$ _____

50. IS REPORT CONTINUED? YES NO 51. CAUTION INDICATORS, ATLS ETC.

52. DATA PROCESS INFORMATION:
 COMPUTER ENTERED DATE 3.8.99
 MICROFILM INDEXED INITIAL KS
 IS CASE CLASSIFICATION CORRECT? N
 IF N HAS CORRECTION BEEN MADE? N

53. FILE APPROVAL
 BY KP DATE 03.08.99

01090 129411, 1171990

INCIDENT # **CS 599-00242**

5. INCIDENT LOCATION
Hwy CR & Silver Crk Rd.

6. NAME- LAST-FIRST-MI
WLUK - Fox II

7. D.O.B.

8. ADDRESS

9. TX-HOME

10. TX-BUSINESS

11. CITY STATE ZIP

12. DETAILS
Informant states a Chev Blazer with grill damage has not been moved from a spot behind

1700

02/05/99

14. REC'D. 15. DISP 16. 10-23 17. 10-24

13. DAY
SUN 1 THU 5
MON 2 **FRI 3**
TUE 3 SAT 7
WED 4

INCIDENT CARD

18. ASSIGNED
Green Bay PD 91413
Bushman 929
H.H.H.

19. REC. BY **925** 20. DIS. BY

21. HOW REC'D.
1. 911
2. POLICE RADIO
3. PHONE
4. TTY
5. IN PERSON
6. ON VIEW
7. OFF. OFF DUTY
8. C.B. RADIO
9. OTHER **PAX**

22. TYPE OF REPORT
1. INCIDENT
2. ACCIDENT
3. CITATION
4. NONE

23. STATUS
1. UNFOUNDED
2. PNL
3. OTHER
4. CLEARED
5. EXCEPT CLEARED

24. DATE CLEARED **02/08/99**

25. OFFENSE TYPE
1. ADULT NA
2. JUVENILE
3. UNKNOWN

39. (CODE S-SUSPECT W-WITNESS V-VICTIM O-OTHER)

CODE	40. NAME-LAST	FIRST	MI	41. D.O.B.	42. ADDRESS	43. TELEPHONE
0	[REDACTED]				[REDACTED]	[REDACTED]

a shed at [REDACTED] Nicolet Dr., Green Bay, for the last few weeks. Informant is willing to talk to police, see attached paperwork. SE SE

02/16/99 1705hrs Attempted contact by phone, not home but should be arriving shortly from work, return number given. M.J.Bushman

02/22/99 1535hrs [REDACTED] is a [REDACTED] with [REDACTED]. He lives in Green Bay Apartment Complex. He noticed shortly after the reports of the accident came out there was an 80's Chev Blazer parked behind a shed at [REDACTED] Nicolet Drive in Green Bay. He stated it looks very suspicious because of where its parked and extremely hard to see unless you know exactly where to look. He did not obtain a plate number. He described the damage as the upper portion of the passenger side of the grille missing. There is no hood bumper or sheet metal damage. Tires are oversize. After listening to me describe the damage he stated; "No I don't believe this is the vehicle your looking for." He then stated he will return tonight while walking and take a second look, but would not call me back unless he overlooked something. Close Out Complaint-M.J.Bushman

CASE #
599
No
01090

45. IF COMPLAINANT DIFFERENT THEN CALLER, ENTER NAME, ADDRESS, D.O.B., TELEPHONE.

46. IF CODE O (OTHER) IS USED IN FIELD #39, EXPLAIN.

INCIDENT REPORT: NOTE: IF SECTION 22 ABOVE HAS NUMBER 4 CHECKED, DO NOT GO BEYOND THIS LINE WITHOUT RECORDS SECTION BEING ADVISED, OR NO RECORD ENTRIES WILL BE MADE BELOW THIS LINE.

PROPERTY VALUE	26. PROPERTY	A. CURRENCY	B. JEWELRY	C. FURS CLOTHING	D. VEHICLE (LOCAL)	E. OFFICE EQUIPMENT	F. RADIO, TV CAMERAS	G. FIREARMS	H. HOUSE-HOLD GOODS
	STOLEN	\$	\$	\$	\$	\$	\$	\$	\$
	RECOVERED	\$	\$	\$	\$	\$	\$	\$	\$
	26. PROPERTY	I. CONSUMABLES	J. LIVESTOCK	K. DRUGS	L. MARINE ITEMS	M. CONSTRUCTION ITEMS	N. LAWN AND GARDEN	O. SPORTING GOODS	P. MISC BICYCLE
	STOLEN	\$	\$	\$	\$	\$	\$	\$	\$
	RECOVERED	\$	\$	\$	\$	\$	\$	\$	\$

27. PROPERTY RECOVERED: LOCALLY _____ OTHER JURISDICTION _____ (INSERT O OR L)

PROPERTY ITEMIZATION	PROPERTY STOLEN/RECOVERED ITEMIZATION, USE THE FOLLOWING FORMAT				
	28. QUANTITY	29. ARTICLE NAME	30. BRAND NAME	31. SERIAL NUMBER	32. CODE
					S R <input type="checkbox"/> <input type="checkbox"/>
					S R <input type="checkbox"/> <input type="checkbox"/>
					S R <input type="checkbox"/> <input type="checkbox"/>
					S R <input type="checkbox"/> <input type="checkbox"/>
					S R <input type="checkbox"/> <input type="checkbox"/>

33. PROPERTY DAMAGE AMOUNT \$ _____

34. INSURANCE COMPANY _____

35. OFFICER ASSAULTED Y N

36. ARSON Y N

37. STRUCTURE CODE _____

38. DAMAGE \$ _____

47. CIB	ENTERED <input type="checkbox"/>	CANCELLED <input type="checkbox"/>
NCIC	<input type="checkbox"/>	<input type="checkbox"/>
OTHER BROADCAST	<input type="checkbox"/>	<input type="checkbox"/>

48. TOTAL AMOUNT PROPERTY STOLEN \$ _____

49. TOTAL AMOUNT PROPERTY RECOVERED \$ _____

50. IS REPORT CONTINUED? YES NO

51. CAUTION INDICATORS, ATLS ETC.

52. DATA PROCESS INFORMATION:

COMPUTER ENTERED DATE 3/8/99
 MICROFILM INDEXED INITIAL AS

53. FILE APPROVAL

IS CASE CLASSIFICATION CORRECT? N
 IF N HAS CORRECTION BEEN MADE? N

BY RP DATE 03/08/99



Lombardi Avenue
P.O. Box [redacted]
Green Bay, WI. 54307-9011

Please deliver the following page (s) to:

Name Lt. Michael Bushman

Location Marty Sheriff's Fax Number [redacted]

From Teri Barr

FOX 11 WLUK-TV, Green Bay- NEWS FAX [redacted]
Regular Business Phone [redacted] Direct Line [redacted]

Total number of pages, including this cover page: 2 Date 2-5-99

Special Instructions: _____

This is new as of Friday afternoon

Teri



Plucks the  feathers! (21% fewer HH's)



Chases the  from the house! (3% fewer HH's)



Reaches further than the  can see! (2% fewer HH's)

**THE 395,000 WLUK FOX 11 HOUSEHOLDS PROVIDE
ADVERTISERS WITH THE REACH ADVANTAGE IN GREEN BAY!**

**MORE WISCONSIN AND
MICHIGAN HOUSEHOLDS
WATCH WLUK FOX 11
DURING AN AVERAGE
WEEK THAN ANY OTHER
GREEN BAY STATION!**

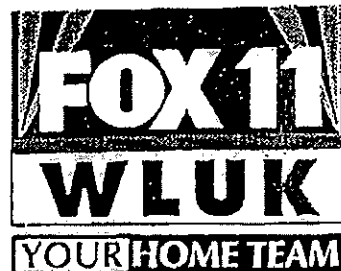

TO: Lt. Michael Bushman

FROM: Teri Barr, FOX-11 News

RE: "Most Wanted" Hit and Run case

We received a call today from [REDACTED] who says he has noticed a 1980's model Chevy blazer sitting behind a shed at [REDACTED] Nicolet Drive in Green Bay. He says the grill is busted out and he says it hasn't moved from the spot behind the shed in weeks. He decided to call after he saw our "Most Wanted" segment and another description of the vehicle.

I talked to his wife later today; they say don't hesitate to call them if you need any more information.

Good luck.

1. CASE # 99 No 01093 2. CLASSIFICATION 6310.11 3. CENSUS 1141000

IDENT 051 599-00242

INCIDENT LOCATION Hwy. CR & Silver CRK RD.

6. NAME - LAST - FIRST - MI 7. D.O.B. Anonymus

8. ADDRESS 9. TX-HOME

11. CITY STATE ZIP 10. TX-BUSINESS

12. DETAILS In the 01/31/99 edition of the Chronicle, caller saw an ad for a '85 Chev Blazer for sale

1830

02/05/99

14. REC'D 15. DISP 16. 10-23 17. 10-24

13. DAY SUN 1 THU 5 MON 2 FRI TUE 3 SAT 7 WED 4

MANITOWOC COUNTY SHERIFF INCIDENT CARD

18. ASSIGNED Sgt. Lenk 204
Bushman 929

19. REC. BY 20. DIS. BY 925

21. HOW REC'D. 1. 911 2. POLICE RADIO 3. PHONE 4. TTY 5. IN PERSON 6. ON VIEW 7. OFF. OFF DUTY 8. C.B. RADIO 9. OTHER

22. TYPE OF REPORT 1. INCIDENT 2. ACCIDENT 3. CITATION 4. NONE

23. STATUS 1. UNFOUNDED 2. PNL 3. OTHER 4. CLEARED 5. EXCEPT CLEARED

24. DATE CLEARED 03/08/99

25. OFFENSE TYPE 1. ADULT 2. JUVENILE 3. UNKNOWN

39. (CODE S-SUSPECT W-WITNESS V-VICTIM O-OTHER)

CODE	40. NAME - LAST	FIRST	MI	41. D.O.B.	42. ADDRESS	43. TELEPHONE
0	HUEBNER	DARYL	J.		S. 24TH ST MTWC	
0	Korte	Christopher L.			So. 25th, Mtwc	

for \$250 dollars. The ad states the vehicle needs a new engine. Caller states this is suspicious because he feels the vehicle is worth approx. \$900. Caller also traced the phone number provided in the ad [redacted] in his 1986 reverse directory, the corresponding name given was Daryl J. Huebner. Then caller looked up Mr. Huebner in a current phone book and the number given there was [redacted]. Caller also feels this is suspicious and feels Mr. Huebner put his old phone number in the ad because he's hiding something. SESE

02/17/99 1300hrs Contact made with Christopher L.Korte by phone. He is currently living at [redacted] So.25th St.,Mtwc. and has been for approximately four years. The phone number was given to him when he moved in. He did sell the 85 Chev Blazer. I don't doubt the phone number was Daryl J.Huebner's in 1986 but this is 1999. There was no damage to the Blazer, it was without an engine in January. Close M.J.Bushman

45. IF COMPLAINANT DIFFERENT THEN CALLER, ENTER NAME, ADDRESS, D.O.B., TELEPHONE.

46. IF CODE O (OTHER) IS USED IN FIELD #39, EXPLAIN.

INCIDENT REPORT: NOTE: IF SECTION 22 ABOVE HAS NUMBER 4 CHECKED, DO NOT GO BEYOND THIS LINE WITHOUT RECORDS SECTION BEING ADVISED, OR NO RECORD ENTRIES WILL BE MADE BELOW THIS LINE.

PROPERTY VALUE	26. PROPERTY	A. CURRENCY	B. JEWELRY	C. FURS CLOTHING	D. VEHICLE (LOCAL)	E. OFFICE EQUIPMENT	F. RADIO, TV CAMERAS	G. FIREARMS	H. HOUSE-HOLD GOODS
	STOLEN	\$	\$	\$	\$	\$	\$	\$	\$
	RECOVERED	\$	\$	\$	\$	\$	\$	\$	\$
	26. PROPERTY	I. CONSUM-ABLES	J. LIVESTOCK	K. DRUGS	L. MARINE ITEMS	M. CONSTRUCTION ITEMS	N. LAWN AND GARDEN	O. SPORTING GOODS	P. MISC BICYCLE
STOLEN	\$	\$	\$	\$	\$	\$	\$	\$	
RECOVERED	\$	\$	\$	\$	\$	\$	\$	\$	

27. PROPERTY RECOVERED: LOCALLY _____ OTHER JURISDICTION _____ (INSERT O OR L)

PROPERTY ITEMIZATION	PROPERTY STOLEN/RECOVERED ITEMIZATION, USE THE FOLLOWING FORMAT				
	28. QUANTITY	29. ARTICLE NAME	30. BRAND NAME	31. SERIAL NUMBER	
					S R <input type="checkbox"/> <input type="checkbox"/>
					S R <input type="checkbox"/> <input type="checkbox"/>
					S R <input type="checkbox"/> <input type="checkbox"/>
					S R <input type="checkbox"/> <input type="checkbox"/>

33. PROPERTY DAMAGE AMOUNT \$ _____

34. INSURANCE COMPANY _____

35. OFFICER ASSAULTED Y N

36. ARSON Y N

37. STRUCTURE CODE _____

38. DAMAGE \$ _____

47. CIB
 NCIC
 OTHER BROADCAST

ENTERED	<input type="checkbox"/>	CANCELLED	<input type="checkbox"/>
	<input type="checkbox"/>		<input type="checkbox"/>
	<input type="checkbox"/>		<input type="checkbox"/>

48. TOTAL AMOUNT PROPERTY STOLEN \$ _____

49. TOTAL AMOUNT PROPERTY RECOVERED \$ _____

50. IS REPORT CONTINUED? YES NO

51. CAUTION INDICATORS, ATLS ETC.

52. DATA PROCESS INFORMATION:

COMPUTER ENTERED DATE 13.8.99
 MICROFILM INDEXED INITIAL KS

IS CASE CLASSIFICATION CORRECT?
 IF N HAS CORRECTION BEEN MADE? Y N

53. FILE APPROVAL

BY RP DATE 03.08.99

1. CASE # S99 N^o 01126	2. CLASSIFICATION 6.31011	3. CENSUS 5.21000
4. INCIDENT CS / S99-00242		
5. INCIDENT LOCATION N. 10TH ST.		
6. NAME [REDACTED] ONY	7. D.O.B.	
8. ADDRESS [REDACTED]	9. TX-HOME	
11. CITY [REDACTED]	STATE	ZIP
10. TX-BUSINESS		
12. DETAILS RETS. ANHALTS AT ABOVE LOC HAVE AN OLDER VAN, POSS. A SUBURBAN, UNK. COLOR, MAKE OR LP#. CALLER STATED THAT A WEEK OR SO AFTER		

2152
02-06-99

14. REC'D	15. DISP	16. 10-23	17. 10-24
13. DAY			
SUN 1	THU 5		
MON 2	FRI 6		
TUE 3	SAT 7		
WED 4			

MANITOWOC COUNTY SHERIFF INCIDENT CARD	
18. ASSIGNED Alcaeson	4117 9219
19. REC. BY 938	20. DIS. BY
21. HOW REC'D. 1. 911 2. POLICE RADIO 3. PHONE 4. TTY 5. IN PERSON 6. ON VIEW 7. OFF. OFF DUTY 8. C.B. RADIO 9. OTHER	
22. TYPE OF REPORT 1. INCIDENT 2. ACCIDENT 3. CITATION 4. NONE	
23. STATUS 1. UNFOUNDED 2. PNL 3. OTHER 4. CLEARED 5. EXCEPT CLEARED	
24. DATE CLEARED 03 08 199	
25. OFFENSE TYPE 1. ADULT <input type="checkbox"/> NA <input checked="" type="checkbox"/> 2. JUVENILE <input type="checkbox"/> 3. UNKNOWN <input type="checkbox"/>	

39. (CODE S-SUSPECT W-WITNESS V-VICTIM O-OTHER)						
CODE	40. NAME-LAST	FIRST	MI	41. D.O.B.	42. ADDRESS	43. TELEPHONE
0	Anhalt Trevor C.	54883			[REDACTED] N. 6th st. Manitowoc WI	

02-06-99 Con't.. the accident, hearing pounding coming from the garage at above address. Stated that they were putting a van into this garage, that is usually not used at all. Unk. if any damage at all. To best of knowledge vehicle is still there. Thought this was suspicious and wanted to report it. 938/KB KB

02/09/99 at 0840 Hrs contact was made at the adress of [REDACTED] N 6th street and Trevor Ahalt was advised of the complaint. Anhalt did allow access to his garage and it proved to be empty. Anhalt said he did have a friends truck in the garage for a couple days and the truck was observed in his back yard. The vehicle was a Brown Suburban displaying WI LYV535. The vehicle was checked for front end damage orig^o signs that the front end had been repaired or replaced and it showed signs of neither. This vehicle can be eliminated from suspect list. EJG

EJG

PP 8080

S99 N^o 01126

45. IF COMPLAINANT DIFFERENT THEN CALLER, ENTER NAME, ADDRESS, D.O.B., TELEPHONE.

46. IF CODE O (OTHER) IS USED IN FIELD #39, EXPLAIN.

INCIDENT REPORT: NOTE: IF SECTION 22 ABOVE HAS NUMBER 4 CHECKED, DO NOT GO BEYOND THIS LINE WITHOUT RECORDS SECTION BEING ADVISED, OR NO RECORD ENTRIES WILL BE MADE BELOW THIS LINE.

PROPERTY VALUE	26. PROPERTY	A. CURRENCY	B. JEWELRY	C. FURS CLOTHING	D. VEHICLE (LOCAL)	E. OFFICE EQUIPMENT	F. RADIO, TV CAMERAS	G. FIREARMS	H. HOUSEHOLD GOODS
	STOLEN	\$	\$	\$	\$	\$	\$	\$	\$
	RECOVERED	\$	\$	\$	\$	\$	\$	\$	\$
	26. PROPERTY	I. CONSUMABLES	J. LIVESTOCK	K. DRUGS	L. MARINE ITEMS	M. CONSTRUCTION ITEMS	N. LAWN AND GARDEN	O. SPORTING GOODS	P. MISC BICYCLE
	STOLEN	\$	\$	\$	\$	\$	\$	\$	\$
	RECOVERED	\$	\$	\$	\$	\$	\$	\$	\$

27. PROPERTY RECOVERED: LOCALLY _____ OTHER JURISDICTION _____ (INSERT O OR L)

PROPERTY ITEMIZATION	PROPERTY STOLEN/RECOVERED ITEMIZATION, USE THE FOLLOWING FORMAT				
	28. QUANTITY	29. ARTICLE NAME	30. BRAND NAME	31. SERIAL NUMBER	32. CODE
					S R <input type="checkbox"/> <input type="checkbox"/>
					S R <input type="checkbox"/> <input type="checkbox"/>
					S R <input type="checkbox"/> <input type="checkbox"/>
					S R <input type="checkbox"/> <input type="checkbox"/>

33. PROPERTY DAMAGE AMOUNT \$ _____

34. INSURANCE COMPANY _____

35. OFFICER ASSAULTED Y N

36. ARSON Y N

37. STRUCTURE CODE _____

38. DAMAGE \$ _____

47. CIB ENTERED CANCELLED
 NCIC
 OTHER BROADCAST

48. TOTAL AMOUNT PROPERTY STOLEN \$ _____

49. TOTAL AMOUNT PROPERTY RECOVERED \$ _____

50. IS REPORT CONTINUED? YES NO

51. CAUTION INDICATORS, ATLS ETC.

52. DATA PROCESS INFORMATION:

COMPUTER ENTERED DATE 1.31.99
 MICROFILM INDEXED INITIAL AS

IS CASE CLASSIFICATION CORRECT? Y N
 IF N HAS CORRECTION BEEN MADE? Y N

53. FILE APPROVAL

BY kl DATE 03.08.99

S99 No 01140 631011 1A1011

INCIDENT CARD

4. INCIDENT S/S99-00242

5. INCIDENT LOCATION

6. NAME (LAST-FIRST-MI) ANONYMOUS (2) 7. D.O.B.

8. ADDRESS 9. TX-HOME

11. CITY STATE ZIP 10. TX-BUSINESS

12. DETAILS

RPTS VEHICLE IN BACKYARD WITH BLUE TARP OVER IT WIND BLEW TARP OFF PORTION OF VEHICLE EXPOSING FRONT END DAMAGE - GRAY P.U.

1745 2-7-99

14. REC'D 15. DISP 16. 10-23 17. 10-24 13. DAY SUN 1 THU 5 MON 2 FRI 6 TUE 3 SAT 7 WED 4

18. ASSIGNED MTSO 928 TOST 449

19. REC. BY 939 20. DIS. BY 22. TYPE OF REPORT 1. INCIDENT 2. ACCIDENT 3. CITATION 4. NONE

21. HOW REC'D. 1. 911 2. POLICE RADIO 3. PHONE 4. TTY 5. IN PERSON 6. ON VIEW 7. OFF. OFF DUTY 8. C.B. RADIO 9. OTHER 23. STATUS 1. UNFOUNDED 2. PNL 3. OTHER 4. CLEARED 5. EXCEPT CLEARED

24. DATE CLEARED 10308199 25. OFFENSE TYPE 1. ADULT 2. JUVENILE 3. UNKNOWN

39. (CODE S-SUSPECT W-WITNESS V-VICTIM O-OTHER)

Table with 4 columns: CODE, 40. NAME-LAST FIRST MI, 41. D.O.B., 42. ADDRESS, 43. TELEPHONE

Year unknown. On Hwy 310, between R & Q on northside of 310. House is described as yellow or cream color - 2 to 3 houses east of R.

Vehicle above was checked and it does not match suspect vehicle info. as this is a Chev S-10 model. Damage to this vehicle is also too severe. Information added to S99-00242 MJ

S99 IN 01140

45. IF COMPLAINANT DIFFERENT THEN CALLER, ENTER NAME, ADDRESS, D.O.B., TELEPHONE.

46. IF CODE O (OTHER) IS USED IN FIELD #39, EXPLAIN.

INCIDENT REPORT: NOTE: IF SECTION 22 ABOVE HAS NUMBER 4 CHECKED, DO NOT GO BEYOND THIS LINE WITHOUT RECORDS SECTION BEING ADVISED, OR NO RECORD ENTRIES WILL BE MADE BELOW THIS LINE.

PROPERTY VALUE	26. PROPERTY	A. CURRENCY	B. JEWELRY	C. FURS CLOTHING	D. VEHICLE (LOCAL)	E. OFFICE EQUIPMENT	F. RADIO, TV CAMERAS	G. FIREARMS	H. HOUSE-HOLD GOODS
	STOLEN	\$	\$	\$	\$	\$	\$	\$	\$
	RECOVERED	\$	\$	\$	\$	\$	\$	\$	\$
	26. PROPERTY	I. CONSUMABLES	J. LIVESTOCK	K. DRUGS	L. MARINE ITEMS	M. CONSTRUCTION ITEMS	N. LAWN AND GARDEN	O. SPORTING GOODS	P. MISC BICYCLE
STOLEN	\$	\$	\$	\$	\$	\$	\$	\$	
RECOVERED	\$	\$	\$	\$	\$	\$	\$	\$	

27. PROPERTY RECOVERED: LOCALLY _____ OTHER JURISDICTION _____ (INSERT O OR L)

PROPERTY ITEMIZATION	PROPERTY STOLEN/RECOVERED ITEMIZATION, USE THE FOLLOWING FORMAT				
	28. QUANTITY	29. ARTICLE NAME	30. BRAND NAME	31. SERIAL NUMBER	32. CODE
					S R <input type="checkbox"/> <input type="checkbox"/>
					S R <input type="checkbox"/> <input type="checkbox"/>
					S R <input type="checkbox"/> <input type="checkbox"/>
					S R <input type="checkbox"/> <input type="checkbox"/>
					S R <input type="checkbox"/> <input type="checkbox"/>

33. PROPERTY DAMAGE AMOUNT \$ _____

34. INSURANCE COMPANY _____

35. OFFICER ASSAULTED Y N

36. ARSON Y N

37. STRUCTURE CODE _____

38. DAMAGE \$ _____

47. CIB ENTERED CANCELLED
 NCIC
 OTHER BROADCAST

48. TOTAL AMOUNT PROPERTY STOLEN \$ _____

49. TOTAL AMOUNT PROPERTY RECOVERED \$ _____

50. IS REPORT CONTINUED? YES NO

51. CAUTION INDICATORS, ATLS ETC.

52. DATA PROCESS INFORMATION:

COMPUTER ENTERED DATE 13 8 99

MICROFILM INDEXED INITIAL AS

IS CASE CLASSIFICATION CORRECT? N
 IF N HAS CORRECTION BEEN MADE? N

53. FILE APPROVAL

BY RP DATE 03 08 99

S99 N^o U0881 | 6,3|0,1 | 1,4|0,0,4

4. INCIDENT
CS/S99-00242

5. INCIDENT LOCATION
CTR CL

6. NAME- LAST-FIRST-MI
ANDY. (2)

7. D.O.B.

8. ADDRESS

9. TX-HOME

10. TX-BUSINESS

11. CITY STATE ZIP

12. DETAILS
"BOOTY" MILLER, M/W, IN 60'S,
DRIVES A PICK UP TRUCK - FRIEND
NOTICED DAMAGE TO GRILL & PASS.
SIDE RECENTLY. MILLER LIVES TR AREA.

18 50

INCIDENT CARD

18. ASSIGNED
MTSO 91219
Bushman H/H

19. REC. BY
932

20. DIS. BY
932

21. HOW REC'D.
1. 911
2. POLICE RADIO
3. PHONE
4. TTY
5. IN PERSON
6. ON VIEW
7. OFF. OFF DUTY
8. C.B. RADIO
9. OTHER

22. TYPE OF REPORT
1. INCIDENT
2. ACCIDENT
3. CITATION
4. NONE

23. STATUS
1. UNFOUNDED
2. PNL
3. OTHER
4. CLEARED
5. EXCEPT CLEARED

24. DATE CLEARED
03/08/99

25. OFFENSE TYPE
1. ADULT NA
2. JUVENILE
3. UNKNOWN

21A. M.O.

14. REC'D	15. DISP	16. 10-23	17. 10-24
SUN 1	THU 5	FRI 6	SAT 7
MON 2	TUE 3	WED 4	

39. (CODE S-SUSPECT W-WITNESS V-VICTIM O-OTHER)

CODE	40. NAME-LAST	FIRST	MI	41. D.O.B.	42. ADDRESS	43. TELEPHONE
O	MILLER	GORDON	137105		FLORENCE ST. T.R.	
O	MILLER	GERALD	J. 11181		CLUSTER ST. MOUNTAIN	

02/23/99 Attempted to locate a Booty Miller by forwarding information to James Froelich, Katie Coenen, and T.R.P.D., no one seems to know him. More followup required. M.J. Bushman

02/24/99 1912hrs Contact made at Richard Franz residence. Richard was gone to school tonight. His wife states he would know Booty Miller and will leave note for him to contact MTSO with information later this evening. M.J. Bushman

02/25/99 Received information the "Booty" Miller was Gordon Miller. Attempt to contact made and no one home. Green Ford Truck with pushed in grille on passenger side and cardboard in the grille space in yard, Registration BB84-686. Small Ford escort in the yard covered with snow. There was another Ford p/u and a Dodge p/u in the garage. One space empty in the yard, tire tracks indicated small car.

02/26/99 1700hrs and 2145hrs. Attempted contact no one home. 2200hrs attempted contact by phone and Gordon Miller answered. He was very cooperative and offered to show all his vehicles if Officer wanted. States the grille is out from hitting a deer. Also stated his brother Gerald Miller is nicknamed "Booty". Gordon has not owned a Chev. Product in years and his brother should have a Ford truck and Pontiac sedan.

2241hrs Check made of Gerald J. Miller's truck. It is an 86 Ford, no match, Reg: Be51954. Close Out Complaint. M.J. Bushman

Handwritten initials/signature

45. IF COMPLAINANT DIFFERENT THEN CALLER, ENTER NAME, ADDRESS, D.O.B., TELEPHONE.

46. IF CODE O (OTHER) IS USED IN FIELD #39, EXPLAIN.

INCIDENT REPORT: NOTE: IF SECTION 22 ABOVE HAS NUMBER 4 CHECKED, DO NOT GO BEYOND THIS LINE WITHOUT RECORDS SECTION BEING ADVISED, OR NO RECORD ENTRIES WILL BE MADE BELOW THIS LINE.

PROPERTY VALUE	26. PROPERTY	A. CURRENCY	B. JEWELRY	C. FURS CLOTHING	D. VEHICLE (LOCAL)	E. OFFICE EQUIPMENT	F. RADIO, TV CAMERAS	G. FIREARMS	H. HOUSE-HOLD GOODS
	STOLEN	\$	\$	\$	\$	\$	\$	\$	\$
	RECOVERED	\$	\$	\$	\$	\$	\$	\$	\$
	26. PROPERTY	I. CONSUM-ABLES	J. LIVESTOCK	K. DRUGS	L. MARINE ITEMS	M. CONSTRUCTION ITEMS	N. LAWN AND GARDEN	O. SPORTING GOODS	P. MISC BICYCLE
STOLEN	\$	\$	\$	\$	\$	\$	\$	\$	
RECOVERED	\$	\$	\$	\$	\$	\$	\$	\$	

27. PROPERTY RECOVERED: LOCALLY _____ OTHER JURISDICTION _____ (INSERT O OR L)

PROPERTY ITEMIZATION	PROPERTY STOLEN/RECOVERED ITEMIZATION, USE THE FOLLOWING FORMAT				
	28. QUANTITY	29. ARTICLE NAME	30. BRAND NAME	31. SERIAL NUMBER	32. CODE
					S R <input type="checkbox"/> <input type="checkbox"/>
					S R <input type="checkbox"/> <input type="checkbox"/>
					S R <input type="checkbox"/> <input type="checkbox"/>
					S R <input type="checkbox"/> <input type="checkbox"/>
					S R <input type="checkbox"/> <input type="checkbox"/>

33. PROPERTY DAMAGE AMOUNT \$ _____

34. INSURANCE COMPANY _____

35. OFFICER ASSAULTED Y N

36. ARSON Y N

37. STRUCTURE CODE _____ 38. DAMAGE \$ _____

47. CIB ENTERED CANCELLED
 NCIC
 OTHER BROADCAST

48. TOTAL AMOUNT PROPERTY STOLEN \$ _____

49. TOTAL AMOUNT PROPERTY RECOVERED \$ _____

50. IS REPORT CONTINUED? YES NO

51. CAUTION INDICATORS, ATLS ETC.

52. DATA PROCESS INFORMATION:

COMPUTER ENTERED DATE 3.8.99

MICROFILM INDEXED INITIAL AS

IS CASE CLASSIFICATION CORRECT? N
 IF N HAS CORRECTION BEEN MADE? Y N

53. FILE APPROVAL

BY [Signature] DATE 03/08/99

S99 No 00887 6.30.11 120000

INCIDENT CARD

4. INCIDENT: CS/599-00242

5. INCIDENT LOCATION

6. NAME - LAST - FIRST - MI: ANONYMOUS (2) 7. D.O.B.

8. ADDRESS 9. TX-HOME

11. CITY STATE ZIP 10. TX-BUSINESS

12. DETAILS
Saw a Chev truck w/ front end damage plate # is either AJ 52545, or 54525, or 52554

18. ASSIGNED: MATSO 929
BUSHMAN 441

19. REC. BY: 945 20. DIS. BY: -

21. HOW REC'D:
1. 911
2. POLICE RADIO
3. PHONE
4. TTY
5. IN PERSON
6. ON VIEW
7. OFF. OFF DUTY
8. C.B. RADIO
9. OTHER CS

22. TYPE OF REPORT:
1. INCIDENT
2. ACCIDENT
3. CITATION
4. NONE

23. STATUS:
1. UNFOUNDED
2. PNL
3. OTHER
4. CLEARED
5. EXCEPT CLEARED

24. DATE CLEARED: 03/08/99

25. OFFENSE TYPE:
1. ADULT NA
2. JUVENILE
3. UNKNOWN

14. RECD.	15. DISP	16. 10-23	17. 10-24
13. DAY			
SUN 1	THU 5		
MON 2	FRI 6		
TUE 3	SAT 7		
WED 4			

39. (CODE S-SUSPECT W-WITNESS V-VICTIM O-OTHER)				42. ADDRESS		43. TELEPHONE
CODE	40. NAME-LAST	FIRST	MI	41. D.O.B.		

02/17/99 1340hrs Registration check made on above numbers given. No record for AJ52545 or AJ54525. Registration for AJ52554 comes back to a Harold J. or Margaret Marth [REDACTED] CTH N, Milladore on a 1994 GMC truck. Vehicle does not fit description of suspect vehicle. This Comp. closed pending new lead. M.J. Bushman

MJB

45. IF COMPLAINANT DIFFERENT THEN CALLER, ENTER NAME, ADDRESS, D.O.B., TELEPHONE.

46. IF CODE O (OTHER) IS USED IN FIELD #39, EXPLAIN.

INCIDENT REPORT: NOTE: IF SECTION 22 ABOVE HAS NUMBER 4 CHECKED, DO NOT GO BEYOND THIS LINE WITHOUT RECORDS SECTION BEING ADVISED, OR NO RECORD ENTRIES WILL BE MADE BELOW THIS LINE.

PROPERTY VALUE	26. PROPERTY	A. CURRENCY	B. JEWELRY	C. FURS CLOTHING	D. VEHICLE (LOCAL)	E. OFFICE EQUIPMENT	F. RADIO, TV CAMERAS	G. FIREARMS	H. HOUSE-HOLD GOODS
	STOLEN	\$	\$	\$	\$	\$	\$	\$	\$
	RECOVERED	\$	\$	\$	\$	\$	\$	\$	\$
	26. PROPERTY	I. CONSUM-ABLES	J. LIVESTOCK	K. DRUGS	L. MARINE ITEMS	M. CONSTRUCTION ITEMS	N. LAWN AND GARDEN	O. SPORTING GOODS	P. MISC BICYCLE
	STOLEN	\$	\$	\$	\$	\$	\$	\$	\$
	RECOVERED	\$	\$	\$	\$	\$	\$	\$	\$

27. PROPERTY RECOVERED: LOCALLY _____ OTHER JURISDICTION _____ (INSERT O OR L)

PROPERTY ITEMIZATION	PROPERTY STOLEN/RECOVERED ITEMIZATION, USE THE FOLLOWING FORMAT				
	28. QUANTITY	29. ARTICLE NAME	30. BRAND NAME	31. SERIAL NUMBER	32. CODE
					S R <input type="checkbox"/> <input type="checkbox"/>
					S R <input type="checkbox"/> <input type="checkbox"/>
					S R <input type="checkbox"/> <input type="checkbox"/>
					S R <input type="checkbox"/> <input type="checkbox"/>

33. PROPERTY DAMAGE AMOUNT \$ _____

34. INSURANCE COMPANY _____

35. OFFICER ASSAULTED Y N

36. ARSON Y N

37. STRUCTURE CODE _____

38. DAMAGE \$ _____

47. CIB ENTERED CANCELLED
 NCIC
 OTHER BROADCAST

48. TOTAL AMOUNT PROPERTY STOLEN \$ _____

49. TOTAL AMOUNT PROPERTY RECOVERED \$ _____

50. IS REPORT CONTINUED? YES NO

51. CAUTION INDICATORS, ATLS ETC.

52. DATA PROCESS INFORMATION:

COMPUTER ENTERED DATE 3.8.99
 MICROFILM INDEXED INITIAL AS

53. FILE APPROVAL

IS CASE CLASSIFICATION CORRECT? N
 IF N HAS CORRECTION BEEN MADE? Y

BY RP DATE 03.08.99

S99 N# 00948 6,310,11, 521000

INCIDENT CARD

4. INCIDENT
CS/S99-00242

5. INCIDENT LOCATION
CALUMET AVE CTH CR

6. NAME - LAST - FIRST - MI
ANONYMOUS (2) 7. D.O.B.

8. ADDRESS 9. TX-HOME

11. CITY STATE ZIP 10. TX-BUSINESS

12. DETAILS
REPORTS SEEING CHEV BLAZER
RP SYT198 w/ GRILLE DAMAGE IN
WALGREENS PARKING LOT.

1606 1-31-99

14. REC'D.	15. DISP	16. 10-23	17. 10-24
SUN 1	THU 5		
MON 2	FRI 6		
TUE 3	SAT 7		
WED 4			

18. ASSIGNED
MTS... 9/2/99
Glaeser 4/1/99

19. REC. BY 20. DIS. BY
939 939

21. HOW REC'D.
1. 911
2. POLICE RADIO
3. PHONE
4. TTY
5. IN PERSON
6. ON VIEW
7. OFF. OFF DUTY
8. C.B. RADIO
9. OTHER

22. TYPE OF REPORT
1. INCIDENT
2. ACCIDENT
3. CITATION
4. NONE

23. STATUS
1. UNFOUNDED
2. PNL
3. OTHER
4. CLEARED
5. EXCEPT CLEARED

24. DATE CLEARED 108 08 99

25. OFFENSE TYPE
1. ADULT NA
2. JUVENILE
3. UNKNOWN

39. (CODE S-SUSPECT W-WITNESS V-VICTIM O-OTHER)

CODE	40. NAME - LAST	FIRST	MI	41. D.O.B.	42. ADDRESS	43. TELEPHONE
O	MAROTZ	RODNEY	P		Marshall St, Manitowoc	

02/18/99: After doing leg work on this vehicle for several days from the 16th and 17th, I (Deputy Glaeser) was able to locate the vehicle at METAL WARE in Two Rivers. I observed it was a brown and white K5 Blazer bearing WI RP SYT198. The Blazer had damage to the right front grill area, but it should be noted the grill was chrome and had black trim paint.

This would not meet the parameters of our suspect vehicle, so this one can be eliminated from the suspect list.

No further action taken. EJGlaeser /bjc

pp 83 87

45. IF COMPLAINANT DIFFERENT THEN CALLER, ENTER NAME, ADDRESS, D.O.B., TELEPHONE.

46. IF CODE O (OTHER) IS USED IN FIELD #39, EXPLAIN.

INCIDENT REPORT: NOTE: IF SECTION 22 ABOVE HAS NUMBER 4 CHECKED, DO NOT GO BEYOND THIS LINE WITHOUT RECORDS SECTION BEING ADVISED, OR NO RECORD ENTRIES WILL BE MADE BELOW THIS LINE.

PROPERTY VALUE	26. PROPERTY	A. CURRENCY	B. JEWELRY	C. FURS CLOTHING	D. VEHICLE (LOCAL)	E. OFFICE EQUIPMENT	F. RADIO, TV CAMERAS	G. FIREARMS	H. HOUSE-HOLD GOODS
	STOLEN	\$	\$	\$	\$	\$	\$	\$	\$
	RECOVERED	\$	\$	\$	\$	\$	\$	\$	\$
	26. PROPERTY	I. CONSUM-ABLES	J. LIVESTOCK	K. DRUGS	L. MARINE ITEMS	M. CONSTRUCTION ITEMS	N. LAWN AND GARDEN	O. SPORTING GOODS	P. MISC BICYCLE
	STOLEN	\$	\$	\$	\$	\$	\$	\$	\$
	RECOVERED	\$	\$	\$	\$	\$	\$	\$	\$

27. PROPERTY RECOVERED: LOCALLY _____ OTHER JURISDICTION _____ (INSERT O OR L)

PROPERTY ITEMIZATION	PROPERTY STOLEN/RECOVERED ITEMIZATION, USE THE FOLLOWING FORMAT				
	28. QUANTITY	29. ARTICLE NAME	30. BRAND NAME	31. SERIAL NUMBER	32. CODE
					S R <input type="checkbox"/> <input type="checkbox"/>
					S R <input type="checkbox"/> <input type="checkbox"/>
					S R <input type="checkbox"/> <input type="checkbox"/>
					S R <input type="checkbox"/> <input type="checkbox"/>

33. PROPERTY DAMAGE AMOUNT \$ _____

34. INSURANCE COMPANY _____

35. OFFICER ASSAULTED Y N 36. ARSON Y N 37. STRUCTURE CODE _____ 38. DAMAGE \$ _____

47. CIB ENTERED CANCELLED
 NCIC
 OTHER BROADCAST

48. TOTAL AMOUNT PROPERTY STOLEN \$ _____

49. TOTAL AMOUNT PROPERTY RECOVERED \$ _____

50. IS REPORT CONTINUED? YES NO

51. CAUTION INDICATORS, ATLS ETC.

52. DATA PROCESS INFORMATION:

COMPUTER ENTERED DATE 3/8/99
 MICROFILM INDEXED INITIAL RS

53. FILE APPROVAL

BY R DATE 03/08/99

IS CASE CLASSIFICATION CORRECT? Y N
 IF N HAS CORRECTION BEEN MADE? Y N

S99 INE 01100 MAUSA, P. MICHIGAN

4. INCIDENT S99-00242

5. INCIDENT LOCATION

6. NAME - LAST - FIRST - MI ANONYMOUS 7. D.O.B.

9. TX-HOME

11. CITY STATE ZIP 10. TX-BUSINESS

12. DETAILS
INFO FROM MENASH P.D. - MAY
HAVE INFORMATION ON H+R (FATAL)
CONTACT DET. LINGNOSKI (MENASHA P.D.)

INCIDENT CARD

18. ASSIGNED DET. SGT. LENK 2014
MTSO 929

19. REC. BY Qmz 20. DIS. BY Qmz

21. HOW REC'D.
 1. 911
 2. POLICE RADIO
 3. PHONE
 4. TTY
 5. IN PERSON
 6. ON VIEW
 7. OFF. OFF DUTY
 8. C.B. RADIO
 9. OTHER

22. TYPE OF REPORT
 1. INCIDENT
 2. ACCIDENT
 3. CITATION
 4. NONE

23. STATUS
 1. UNFOUNDED
 2. PNL
 3. OTHER
 4. CLEARED
 5. EXCEPT CLEARED

24. DATE CLEARED 10/16/99

25. OFFENSE TYPE
 1. ADULT NA
 2. JUVENILE
 3. UNKNOWN

14. REC'D 15. DISP 16. 10-23 17. 10-24
 13. DAY
 SUN 1 THU 5
 MON 2 FRI 6
 TUE 3 SAT 7
 WED 4

21A. M.O.

ACTIVE

39. (CODE S-SUSPECT W-WITNESS V-VICTIM O-OTHER)	40. NAME-LAST	FIRST	MI	41. D.O.B.	42. ADDRESS	43. TELEPHONE
0	SOKE					
0	SOKE	MAUREEN	E		6th St, Menasha	
0	SOKE	RICHARD	J		6th St, Menasha	
0	CHAPLEAU	AIMEE	S		Edna Ave, Neenah	

02/03/99: I, Det. Sgt. J. Lenk, received a telephone call from Det. Joe Lingnofski from Menasha PD, phone of [REDACTED]. Det. Lingnofski stated he got information from RICHARD SOKEL that RICHARD'S wife, MAUREEN SOKEL, works at the BANTA MEDIA CORP. MAUREEN overheard 2 girls talking about an accident which she thought was the hit and run accident we are investigating. One of the girls who was talking was AIMEE CHAPLEAU who works at BANTA MEDIA but also works at the BUTTERFLY BAR in Neenah as a part-time bartender. MAUREEN stated she overheard these girls talking, and she stated AIMEE made a statement that she knows who did the hit and run but she told the other girl she would not divulge the name. Det. Lingnofski stated I should contact Lt. Bob Wallner from Neenah PD at [REDACTED] to see if they could check out AIMEE in regard to the hit and run accident.

02/03/99 @ 1240 Hrs.: I contacted Lt. Wallner of Neenah PD. He stated he would check out the lead with AIMEE at her residence. He stated he will call back with information probably on Friday when his partner comes back to work.

02/05/99: I received contact from Det. Jay Karner of Neenah PD. He stated he will be checking on this lead along with his partner, Lt. Wallner. They will be conducting an interview with AIMEE regarding this information.

02/08/99: I received a telephone call from Det. Karner who stated they did in fact make contact with AIMEE. She has no knowledge of the hit and run fatal accident. She stated she was talking about a prior, unrelated accident when she was overheard talking. Officers also checked her and her associates who would have a possible match for the vehicle in question. There were negative results with this.

This incident should be considered closed and not relevant to the investigation of the hit and run fatal accident of S99-00242. JMLenk /bjc

CASE # S99 No 01153

45. IF COMPLAINANT DIFFERENT THEN CALLER, ENTER NAME, ADDRESS, D.O.B., TELEPHONE.

46. IF CODE O (OTHER) IS USED IN FIELD #39, EXPLAIN.

INCIDENT REPORT: NOTE: IF SECTION 22 ABOVE HAS NUMBER 4 CHECKED, DO NOT GO BEYOND THIS LINE WITHOUT RECORDS SECTION BEING ADVISED, OR NO RECORD ENTRIES WILL BE MADE BELOW THIS

PROPERTY VALUE	26. PROPERTY	A. CURRENCY	B. JEWELRY	C. FURS CLOTHING	D. VEHICLE (LOCAL)	E. OFFICE EQUIPMENT	F. RADIO-TV CAMERAS	G. FIREARMS	H. HOUSE-HOLD GOODS
	STOLEN	\$	\$	\$	\$	\$	\$	\$	\$
	RECOVERED	\$	\$	\$	\$	\$	\$	\$	\$
	26. PROPERTY	I. CONSUMABLES	J. LIVESTOCK	K. DRUGS	L. MARINE ITEMS	M. CONSTRUCTION ITEMS	N. LAWN AND GARDEN	O. SPORTING GOODS	P. MISC BICYCLE
	STOLEN	\$	\$	\$	\$	\$	\$	\$	\$
	RECOVERED	\$	\$	\$	\$	\$	\$	\$	\$

27. PROPERTY RECOVERED: LOCALLY ____ OTHER JURISDICTION ____ (INSERT O OR L)

PROPERTY ITEMIZATION	PROPERTY STOLEN/RECOVERED ITEMIZATION, USE THE FOLLOWING FORMAT				
	28. QUANTITY	29. ARTICLE NAME	30. BRAND NAME	31. SERIAL NUMBER	
					S R <input type="checkbox"/> <input type="checkbox"/>
					S R <input type="checkbox"/> <input type="checkbox"/>
					S R <input type="checkbox"/> <input type="checkbox"/>
					S R <input type="checkbox"/> <input type="checkbox"/>
					S R <input type="checkbox"/> <input type="checkbox"/>

33. PROPERTY DAMAGE AMOUNT \$ _____ 34. INSURANCE COMPANY _____

35. OFFICER ASSAULTED Y N 36. ARSON Y N 37. STRUCTURE CODE _____ 38. DAMAGE \$ _____

47. CIB NCIC OTHER BROADCAST	ENTERED	CANCELLED	48. TOTAL AMOUNT PROPERTY STOLEN \$ _____
	<input type="checkbox"/>	<input type="checkbox"/>	
	<input type="checkbox"/>	<input type="checkbox"/>	
			49. TOTAL AMOUNT PROPERTY RECOVERED \$ _____

50. IS REPORT CONTINUED? YES NO 51. CAUTION INDICATORS, ATLS ETC.

52. DATA PROCESS INFORMATION:
 COMPUTER ENTERED DATE 3/8/99
 MICROFILM INDEXED INITIAL AS
 IS CASE CLASSIFICATION CORRECT? Y N
 IF N HAS CORRECTION BEEN MADE? Y N

53. FILE APPROVAL
 BY [Signature] DATE 02/16/99

599 INE 01153

4. INCIDENT
CS/599-00242

5. INCIDENT LOCATION

6. NAME - LAST - FIRST - MI

7. D.O.B.

8. ADDRESS

9. TX-HOME

11. CITY STATE ZIP

10. TX-BUSINESS

12. DETAILS
*INFO. FROM MENASH P.D. - MAY
HAVE INFORMATION ON H+R (FATAL)
CONTACT DET. Lingnolski (Menasha P.D.)*

090399

INCIDENT CARD

18. ASSIGNED
DET. SGT. LENK 2014

19. REC. BY
Qmx

20. DIS. BY
Qmx

22. TYPE OF REPORT
 INCIDENT
 ACCIDENT
 CITATION
 NONE

21. HOW REC'D.
1. 911
2. POLICE RADIO
3. PHONE
4. TTY
5. IN PERSON
6. ON VIEW
7. OFF. OFF DUTY
8. C.B. RADIO
9. OTHER

23. STATUS
1. UNFOUNDED
2. PNL
3. OTHER
4. CLEARED
5. EXCEPT CLEARED

24. DATE CLEARED

25. OFFENSE TYPE
1. ADULT NA
2. JUVENILE
3. UNKNOWN

14. REC'D
15. DISP
16. 10-23
17. 10-24

13. DAY
SUN 1 THU 5
MON 2 FRI 6
TUE 3 SAT 7
WED 4

39. (CODE S-SUSPECT W-WITNESS V-VICTIM O-OTHER)							
CODE	40. NAME-LAST	FIRST	MI	41. D.O.B.	42. ADDRESS	43. TELEPHONE	
0	SOKEL	MAUREEN E.			6TH. ST. MENASHA		
0	SOKEL	ROBERT J.			6TH. ST. MENASHA		
0	CHAPLEAU	AIMEE S.			EDNA AVE., NEENAH		

LT. BOB WALLNER > Neenah P.O.
DET. JAY KARNER >

[REDACTED] (pages) [REDACTED]

02-08-98: T.T. Aimee - she has no knowledge about the H+R (Fatal). No vch.'s associated with her would be a match.
(Per. Det. Karner.)

CITIZEN
1971 N. of Johnson Creek.

01-10-77
0225 HRS.

Suburban OR FLU.
85-91 Chev. VAN.

Re: 599-00242.

[REDACTED]

DET. JOE LINGNOSKI - Menasha P.D. (920) [REDACTED]

FAX [REDACTED]

over
heard

Richard J. SOKEL [REDACTED]

MAUREEN E. SOKEL [REDACTED]

[REDACTED] 6TH. ST. - MENASHA [REDACTED]

- all girls work at BANTA Media (Maureen overheard 2 girls talking) (Aimee)

Aimee Chapleau (works at Butterfly Bar in Neenah as bartender) (Pt. Time)

Knows who did the hit ~~maureen~~ - she told the other girls who did it. (Aimee knows who did it) - maybe the boyfriend?

[REDACTED] EDNA AVE., Neenah.

PH. # [REDACTED]

LT. Bob Wallner - [REDACTED] (Neenah P.D.)

02-03-99 @ 1105 hrs. - attempt to contact Maureen Sokel - No ANSWER.

02-03-99 @ 1153 hrs - attempt to contact Det. Lingnoski - left a message.

02-03-99 @ 1240 hrs. - Lt. Bob Wallner - stated he would check out the lead with Aimee Chapleau, [REDACTED] Edna Ave., Neenah - he will call back. Will be back on Friday - will call us then.

02/05/99 Det. Jay Karner [REDACTED]

1030 : Will be checking on this & will interview the Aimee Chapleau

Pager: [REDACTED]

599-00242

02/04/99

~~Jeremy J. VANEGREN~~
m/w [REDACTED]

~~Joseph A. CLOHESSEY~~
m/w [REDACTED]

~~Tammy K. KIMBALL~~
F/w [REDACTED]

10-27 # Alpha check for
Vehicles

Sgt. Lenh

920- [REDACTED]

BOTTLE
BAR IN
Near
Arlene
(BARTENDER)
CHAPLEAU
EDNA
AV
Mewasha -
BANTA
MEDIA

JOE LINGNOFSKI

MAUREEN E 08715131

RICHARD J SOKEL

[REDACTED]

[REDACTED] 6th ST

[REDACTED]



FAX TRANSMISSION SHEET

City of Menasha • Police Department

DATE 2-3-99

TO Det. Sgt. Jim L

FAX # [REDACTED]

FROM Joc Lingnofski

We are sending _____ pages, including this page.

If you do not receive all pages, please call us back as soon as possible at [REDACTED].

COMMENTS Aimee S. Chapleau [REDACTED] Edna Ave
DOB: [REDACTED] Neenah, Wi.

TRANSMITTING AUTHORITY _____

OPERATOR _____

Robert G. Stanke
Chief of Police

This facsimile contains **CONFIDENTIAL INFORMATION** which may also be legally privileged and which is intended only for the use of the individual or entity named above. If the reader of the facsimile is not the intended recipient, you are hereby on notice that you are in possession of confidential and privileged information. Any dissemination, distribution or copying of this facsimile is strictly prohibited. If you have received this facsimile in error, please immediately notify the sender by telephone (collect) and return the original facsimile to the sender at the above address via the United States Postal Service.

1. CASE # 9 No 01596
 2. CLASSIFICATION 6,310,11
 3. CENSUS 741011

MANITOWOC COUNTY SHERIFF
 INCIDENT CARD

4. IDENT CS/S99-00242

5. INCIDENT LOCATION

6. NAME - LAST - FIRST - MI ANon 7. D.O.B.

8. ADDRESS 9. TX-HOME

11. CITY STATE ZIP 10. TX-BUSINESS

12. DETAILS
 Possible suspect vehicle observed in a garage at Center and Newton Rd right after 10-50 and now has disappeared.

14. REC'D 15. DISP 16. 10-23 17. 10-24
 13. DAY
 SUN 1 THU 5
 MON 2 FRI 6
 TUE 3 SAT 7
 WED 4

18. ASSIGNED

19. REC. BY 20. DIS. BY
 920

21. HOW REC'D.
 1. 911
 2. POLICE RADIO
 3. PHONE
 4. CITY
 5. IN PERSON
 6. ON VIEW
 7. OFF. OFF DUTY
 8. C.B. RADIO
 9. OTHER
 21A. M.O.

22. TYPE OF REPORT
 1. INCIDENT
 2. ACCIDENT
 3. CITATION
 4. NONE

23. STATUS
 1. UNFOUNDED
 2. PNL
 3. OTHER
 4. CLEARED
 5. EXCEPT CLEARED

24. DATE CLEARED 03/08/99

25. OFFENSE TYPE
 1. ADULT NA
 2. JUVENILE
 3. UNKNOWN

39. (CODE S-SUSPECT W-WITNESS V-VICTIM O-OTHER)	40. NAME-LAST	FIRST	MI	41. D.O.B.	42. ADDRESS	43. TELEPHONE
0	PHIPPS	WILLIAM	T		CTH C MTWOC	
0	TEMME	TROY	A		S. UNION RD NEWTON	
0	ROSS	RAYMOND	B		WILLEVER NEWTON	

02/23/99: I, Lt. M. Bushman, went to NEWTON FIRE DEPT. at the intersection of Center Rd and Carstens Lake Rd for a talk with EMS personnel. After the meeting, an anonymous gentleman approached me and advised that he had information on an individual by the name of TROY TEMME who told him the suspect vehicle we were looking for was possibly in the old FIRST CHRYSLER garage, at the intersection of Center Rd and Newton Rd, for 3 days after the accident occurred. The vehicle has since disappeared and is no longer in the area. It was also learned the owner of the property is WILLIAM PHIPPS.

02/24/99 @ 1350 Hrs.: Contact was made with WILLIAM PHIPPS at his garage near the intersection of Newton Rd and Center Rd. He was asked about the possibility of a Chevrolet van parked in his garage for approximately 3 days after the accident took place (01/10/99). PHIPPS stated he is the only individual who had access to the building during that period of time and stated business was a bit slow so he was not there everyday; however, he was there at least every other day. The only vans that should have been parked in the building were his own white Ford van used in his business and possibly a van owned by DARREN and ROBERT KLEIN who live at Center Rd, Manitowoc. KLEIN parked the vehicle there overnight in early January. He was unaware of the exact date as they did some minor maintenance work on it. It would have been a blue Dodge van. PHIPPS was very cooperative and could not remember when the last time was that any other van/vehicle would have been parked in the garage.

Contact by phone was made with TROY TEMME. TEMME advised he received the information about the Chevrolet van parked in the garage from RAYMOND ROSS on 02/09/99 at the Newton Fire-fighters Annual Meeting. TEMME went to the garage shortly after the meeting to see if there was in fact a van parked inside; however, he did not see any and did not get out of the vehicle and walk around the building. He stated the person who gave him the information was RAYMOND ROSS. TEMME himself never saw a van in the PHIPPS garage.

02/24/99 @ 1600 Hrs.: Contact by phone was made with RAYMOND ROSS. ROSS stated his wife is a Newton First Responder and was paged to respond to the accident on 01/10/99. While she was responding, she went through the intersection of Center Rd and Newton Rd but was called off from going all the way to the accident scene while she was in the area of CTH CR

REC'D - CIVIL

45. IF COMPLAINANT DIFFERENT THEN CALLER, ENTER NAME, ADDRESS, D.O.B., TELEPHONE.

46. IF CODE O (OTHER) IS USED IN FIELD #39, EXPLAIN.

INCIDENT REPORT: NOTE: IF SECTION 22 ABOVE HAS NUMBER 4 CHECKED, DO NOT GO BEYOND THIS LINE WITHOUT RECORDS SECTION BEING ADVISED, OR NO RECORD ENTRIES WILL BE MADE BELOW THIS LINE.

PROPERTY VALUE	26. PROPERTY	A. CURRENCY	B. JEWELRY	C. FURS CLOTHING	D. VEHICLE (LOCAL)	E. OFFICE EQUIPMENT	F. RADIO, TV CAMERAS	G. FIREARMS	H. HOUSE-HOLD GOODS
	STOLEN	\$	\$	\$	\$	\$	\$	\$	\$
	RECOVERED	\$	\$	\$	\$	\$	\$	\$	\$
	26. PROPERTY	I. CONSUMABLES	J. LIVESTOCK	K. DRUGS	L. MARINE ITEMS	M. CONSTRUCTION ITEMS	N. LAWN AND GARDEN	O. SPORTING GOODS	P. MISC BICYCLE
STOLEN	\$	\$	\$	\$	\$	\$	\$	\$	
RECOVERED	\$	\$	\$	\$	\$	\$	\$	\$	

27. PROPERTY RECOVERED: LOCALLY OTHER JURISDICTION (INSERT O OR L)

PROPERTY ITEMIZATION	PROPERTY STOLEN/RECOVERED ITEMIZATION, USE THE FOLLOWING FORMAT				
	28. QUANTITY	29. ARTICLE NAME	30. BRAND NAME	31. SERIAL NUMBER	32. CODE
					S R <input type="checkbox"/> <input type="checkbox"/>
					S R <input type="checkbox"/> <input type="checkbox"/>
					S R <input type="checkbox"/> <input type="checkbox"/>
					S R <input type="checkbox"/> <input type="checkbox"/>

33. PROPERTY DAMAGE AMOUNT \$ _____ 34. INSURANCE COMPANY _____

35. OFFICER ASSAULTED Y N 36. ARSON Y N 37. STRUCTURE CODE _____ 38. DAMAGE \$ _____

47. CIB ENTERED CANCELLED
 NCIC
 OTHER BROADCAST

48. TOTAL AMOUNT PROPERTY STOLEN \$ _____
 49. TOTAL AMOUNT PROPERTY RECOVERED \$ _____

50. IS REPORT CONTINUED? YES NO
 51. CAUTION INDICATORS, ATLS ETC.

52. DATA PROCESS INFORMATION:
 COMPUTER ENTERED DATE 3.8.99
 MICROFILM INDEXED INITIAL AS
 IS CASE CLASSIFICATION CORRECT? Y N
 IF N HAS CORRECTION BEEN MADE? Y N

53. FILE APPROVAL
 BY [Signature] DATE 3.8.99

MANITOWOC COUNTY SHERIFF'S DEPARTMENT
FOLLOW-UP REPORT

Page: 2

CASE NUMBER: 599-01596 CLASSIFICATION: _____

INCIDENT: _____

DATE AND TIME: _____

REPORT CONTINUED:

and CTH C. She then turned west on CTH CR and turned south again on Center Rd, going past the intersection with Newton Rd a second time.

Later, she heard rumors about evidence being found at the intersection of Center Rd and Newton Rd. She became very disturbed as she had traveled through that intersection the night of the incident but could not recall seeing grill parts or any vehicle tracks other than her own the night of the incident. She blamed herself for not being observant and remembering the items laying on the road. When the ROSS family members were made aware the parts were there, they recalled driving through the intersection and observing a light-colored van in the garage which PHIPPS owns. ROSS told me over the phone his wife "had a gut reaction" about the van being parked in the garage.

At no time did they get out and verify whether or not it was a Chevrolet, Ford, or Dodge van. ROSS stated, "I haven't the slightest idea of what make the van was, only that it was a light-colored van." All 3 of the ROSS family members (his son, his wife, and himself) could not recall the exact color of the van which may have been parked there. No RP of definite description of the van was obtained.

Under the circumstances, there has not been a positive identification of the vehicle which would have been parked in PHIPPS' garage. PHIPPS himself stated he generally parks his white company van in the garage facing forward in the same fashion the ROSS family had observed it.

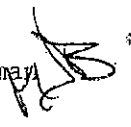
At this point and time, this complaint can be closed. MJBushman  /bjc

1. CASE # S99 No 01971 | 2. CLASSIFICATION 6301 | 3. CENSUS 7.0000

4. INCIDENT 03-599-00242

INCIDENT LOCATION [REDACTED]

6. NAME [REDACTED] | 7. D.O.B. [REDACTED]

ADDRESS [REDACTED] | 9. TX-HOME [REDACTED]

11. CITY [REDACTED] STATE [REDACTED] ZIP [REDACTED] | 10. TX-BUSINESS [REDACTED]

12. DETAILS
 RECEIVED A WISCONSIN RELAY
 PHONE CALL CALLED. DEAF
 PERSON SENDING INFO. FOR
 CRIME STOPPERS. HE SAW VEH.

0850 03/10/99

MANITOWOC COUNTY SHERIFF
INCIDENT CARD

18. ASSIGNED INFO 98
 M.J. BUSHMAN 4/41

19. REC. BY 946 | 20. DIS. BY [REDACTED]
 21. HOW REC'D.
 1. 911
 2. POLICE RADIO
 3. PHONE
 4. TTY
 5. IN PERSON
 6. ON VIEW
 7. OFF. OFF DUTY
 8. C.B. RADIO
 9. OTHER
 21A. M.O. [REDACTED]

22. TYPE OF REPORT
 1. INCIDENT
 2. ACCIDENT
 3. CITATION
 4. NONE

23. STATUS
 1. UNFOUNDED
 2. PNL
 3. OTHER
 4. CLEARED
 5. EXCEPT CLEARED

24. DATE CLEARED 03/30/99

25. OFFENSE TYPE
 1. ADULT NA
 2. JUVENILE
 3. UNKNOWN

39. (CODE S-SUSPECT W-WITNESS V-VICTIM O-OTHER)	40. NAME-LAST	FIRST	MI	41. D.O.B.	42. ADDRESS	43. TELEPHONE
O	Verbetten, John R.	84582		[REDACTED]	Melrose Ct., Kaukauna	[REDACTED]
O	Hatton, Thomas G.	119975		[REDACTED]	Hwy 55, Hilbert, Wi	[REDACTED]

02-10-99 [REDACTED] relayed message giving information on the fatal hit and run. He stated that he was at "The Hawkeye Bar in KK". When asked where this bar is located. He stated, "Look it up in the phone book, this is long distance and I am not rich." He stated that it was a Suburban at that bar. The Suburban had grill and hood damage. He said there was a dent on the hood that looked like a head hit it. The dent was in the shape of a head. He gave me the license plate no# TBG669. License plate was ran and is attached. Would be willing to make contact with police for further information if needed. Need to use the 1-800 no. for relay, or dial direct with TDD phone at [REDACTED] ck946

03/11/99 1508hrs Call placed to Kaukauna PD and a faxed copy of crimestopper report sent. Request for assist made through dispatch. M.J. Bushman

03/11/99 1605hrs call back received from Kaukauna, Verbeten is currently in Little Chute and Fox Valley Metro Unit. Capt Stefancic was sent to locate.

03/11/99: Capt. Stefancic made contact with JOHN VERBETTEN in Little Chute. The vehicle in question is a black 1985 Chevrolet Suburban. The grill is completely gone, and the hood has a dent in the driver side "which definitely looks like it struck a pole." There is a newer bumper on the vehicle and no radiator shroud from a previous accident. VERBETTEN claims the accident happened before he bought the vehicle.

VERBETTEN'S father was also present and when he caught on to the line of questioning, he stated to Capt. Stefancic that the damage to his son's vehicle happened before Christmas, he thought around Thanksgiving. VERBETTEN himself stated the accident happened at a friend's house (friend being THOMAS HATTON) who he thought lived in the Stockbridge area. HATTON'S phone number was given as [REDACTED]. VERBETTEN questioned as to when the accident took place, stating he was in OUSO Jail for over a month, being released on 02/18/99. He stated his vehicle was parked where it is now in Little Chute during that period of time; however, his girlfriend may have used it as her vehicle broken down.

VERBETTEN was very cooperative and allowed Capt. Stefancic to photograph the vehicle. Capt. Stefancic questioned as to where the parts for the vehicle would be if it was damaged at his friend's house. VERBETTEN stated the grill...

S99 No 01971

45. IF COMPLAINANT DIFFERENT THEN CALLER, ENTER NAME, ADDRESS, D.O.B., TELEPHONE.

46. IF CODE O (OTHER) IS USED IN FIELD #39, EXPLAIN.

INCIDENT REPORT: NOTE: IF SECTION 22 ABOVE HAS NUMBER 4 CHECKED, DO NOT GO BEYOND THIS LINE WITHOUT RECORDS SECTION BEING ADVISED, OR NO RECORD ENTRIES WILL BE MADE BELOW THIS LINE.

PROPERTY VALUE	26. PROPERTY	A. CURRENCY	B. JEWELRY	C. FURS CLOTHING	D. VEHICLE (LOCAL)	E. OFFICE EQUIPMENT	F. RADIO, TV CAMERAS	G. WEAPONS	H. HOUSEHOLD GOODS
	STOLEN	\$	\$	\$	\$	\$	\$	\$	\$
	RECOVERED	\$	\$	\$	\$	\$	\$	\$	\$
	26. PROPERTY	I. CONSUMABLES	J. LIVESTOCK	K. DRUGS	L. MARINE ITEMS	M. CONSTRUCTION ITEMS	N. LAWN AND GARDEN	O. SPORTING GOODS	P. MISC BICYCLE
	STOLEN	\$	\$	\$	\$	\$	\$	\$	\$
	RECOVERED	\$	\$	\$	\$	\$	\$	\$	\$

27. PROPERTY RECOVERED: LOCALLY _____ OTHER JURISDICTION _____ (INSERT O OR L)

PROPERTY ITEMIZATION	PROPERTY STOLEN/RECOVERED ITEMIZATION, USE THE FOLLOWING FORMAT				
	28. QUANTITY	29. ARTICLE NAME	30. BRAND NAME	31. SERIAL NUMBER	32. CODE
					S R <input type="checkbox"/> <input type="checkbox"/>
					S R <input type="checkbox"/> <input type="checkbox"/>
					S R <input type="checkbox"/> <input type="checkbox"/>
					S R <input type="checkbox"/> <input type="checkbox"/>

33. PROPERTY DAMAGE AMOUNT \$ _____

34. INSURANCE COMPANY _____

35. OFFICER ASSAULTED Y N

36. ARSON Y N

37. STRUCTURE CODE _____

38. DAMAGE \$ _____

47. CIB ENTERED CANCELLED
 NCIC
 OTHER BROADCAST

48. TOTAL AMOUNT PROPERTY STOLEN \$ _____

49. TOTAL AMOUNT PROPERTY RECOVERED \$ _____

50. IS REPORT CONTINUED? YES NO

51. CAUTION INDICATORS, ATLS ETC.

52. DATA PROCESS INFORMATION:

COMPUTER ENTERED DATE 3/31/99

MICROFILM INDEXED INITIAL AS

IS CASE CLASSIFICATION CORRECT?
 IF N HAS CORRECTION BEEN MADE? Y N

53. FILE APPROVAL

BY *CK*

DATE 03/30/99

MANITOWOC COUNTY SHERIFF'S DEPARTMENT
FOLLOW-UP REPORT

Page: 2

CASE NUMBER: 599-01971 CLASSIFICATION: _____

INCIDENT: _____

DATE AND TIME: _____

REPORT CONTINUED:

During the period of time the grill was being retrieved, I (Lt. M. Bushman) made contact with THOMAS HATTON by phone in Hilbert. HATTON stated his friend, JOHN VERBETTEN, was on his family's property when he struck a ~~POLK~~ with the Suburban. HATTON was unsure of the date; however, he stated it was quite some time ago. Eventually, he stated he thought it was right before Christmas. HATTON stated he was in the vehicle at the time it struck the pole, and the cracked windshield was from his head as he flew forward.

Capt. Stefancic called me back at MTSO, stating VERBETTEN found the grill for the vehicle. It matches and fits perfectly. The damage on the grill at the point where it is cracked and pushed in is consistent with the damage that is on the hood of the vehicle. He stated the center Chevrolet emblem holder is still fully intact as well as the passenger side mounting brackets and pieces where the screws would attach it to the main body of the truck. Capt. Stefancic checked the vehicle tires which were not consistent with the description that I gave, and the tires appeared to have been on the vehicle for quite some time. Also, the wall which holds the radiator in place did not appear to have been damaged at any point in time, nor was it recently repaired.

In light of the explanation given by the owner and verified by 2 other witnesses, it is unlikely this would be the vehicle we are looking for. Capt. Stefancic took several photographs and will forward them to MTSO. I believe this complaint can be closed out.

MJBushman 

/bjc

1. CASE # 599-01120	2. CLASSIFICATION 6.310.11	3. LENSUS 11410.22
4. INCIDENT CS/S99-00242		
5. INCIDENT LOCATION [REDACTED]		
6. NAME- LAST-FIRST-MI ANONYMOUS	7. D.O.B.	
8. ADDRESS	9. TX-HOME	
11. CITY STATE ZIP	10. TX-BUSINESS	
12. DETAILS Reports he may have info. concerning H&R. fatal on CTH CR		

MANITOWOC COUNTY SHERIFF INCIDENT CARD			
18. ASSIGNED LT THORRINGTON 41316		929	
[Signature]		4117	
19. REC. BY 932	20. DIS. BY -	22. TYPE OF REPORT. ① INCIDENT 2. ACCIDENT 3. CITATION 4. NONE	
21. HOW REC'D. 1. 911 2. POLICE RADIO ③ PHONE 4. TTY 5. IN PERSON 6. ON VIEW 7. OFF. OFF DUTY 8. C.B. RADIO 9. OTHER		23. STATUS 1. UNFOUNDED 2. PNL ③ OTHER 4. CLEARED 5. EXCEPT CLEARED	
13. DAY SUN 1 THU 5 MON 2 FRI 6 TUE 3 SAT ⑦ WED 4		24. DATE CLEARED 10308 199	
21A. M.O.		25. OFFENSE TYPE 1. ADULT <input type="checkbox"/> NA <input checked="" type="checkbox"/> 2. JUVENILE <input type="checkbox"/> 3. UNKNOWN <input type="checkbox"/>	

1445
2-6-99

39. (CODE S-SUSPECT W-WITNESS V-VICTIM O-OTHER)					
40. NAME- LAST	FIRST	MI	41. D.O.B.	42. ADDRESS	43. TELEPHONE
OLSON	ROBERT	D	[REDACTED]	Gass Lake Rd, Manitowoc	[REDACTED]

02-06-99 1245 The caller asked for the Sheriff and was advised the Sheriff was not in at the moment. Caller did not ID himself but does indicate he lives at [REDACTED] as well as another subject who resides at the end of the driveway at the same address. Apparently last evening the other gentleman named "Bob" came home in an intoxicated state and backed into a vehicle that was in the callers driveway. Bob drove off with the caller and owner of vehicle watching him drive off. Caller does not want report on that incident. "Bob" was driving a gray Dodge at the time.

Caller further states that officers have come to his residence to check on a suspect vehicle. Apparently he informed officers that "Bob" has other vehicles at his residence some of which are older trucks. According to the caller the officers never drove further back to check Bobs residence. Caller was given info we had concerning the possible suspect vehicle but still feels this may be a subject to check on.

Lt. Thorrrington *LT*

02/16/99 @ 1100 Hrs.: I, Deputy E. Glaeser, made contact with ROBERT OLSON reference this complaint. OLSON was advised we received a Crime Stopper report that he may be in possession of a Chevrolet pickup truck or van which matches the description of our hit and run vehicle.

It should be noted, prior to making contact with OLSON, I ran an alpha check through State patrol. That did indicate OLSON had registered in his name a Dodge van and a Dodge pickup truck. It further stated there were no Chevrolet pickup trucks on the alpha check.

In speaking with OLSON, he relayed he owned no Chevy vehicles. He offered me to check out the storage barns and garages on his property. I did a thorough search of all the storage buildings and found no Chevrolet vehicles to be on the property.

no further follow-up needed. EJGlaeser *EJG* /bjc

CASE # 599-01120

0.17

45. IF COMPLAINANT DIFFERENT THEN CALLER, ENTER NAME, ADDRESS, D.O.B., TELEPHONE.

46. IF CODE O (OTHER) IS USED IN FIELD #39, EXPLAIN.

INCIDENT REPORT: NOTE: IF SECTION 22 ABOVE HAS NUMBER 4 CHECKED, DO NOT GO BEYOND THIS LINE WITHOUT RECORDS SECTION BEING ADVISED, OR NO RECORD ENTRIES WILL BE MADE BELOW THIS LINE.

PROPERTY VALUE	26. PROPERTY	A. CURRENCY	B. JEWELRY	C. FURS CLOTHING	D. VEHICLE (LOCAL)	E. OFFICE EQUIPMENT	F. RADIO, TV CAMERAS	G. FIREARMS	H. HOUSEHOLD GOODS
	STOLEN	\$	\$	\$	\$	\$	\$	\$	\$
	RECOVERED	\$	\$	\$	\$	\$	\$	\$	\$
	26. PROPERTY	I. CONSUMABLES	J. LIVESTOCK	K. DRUGS	L. MARINE ITEMS	M. CONSTRUCTION ITEMS	N. LAWN AND GARDEN	O. SPORTING GOODS	P. MISC BICYCLE
	STOLEN	\$	\$	\$	\$	\$	\$	\$	\$
	RECOVERED	\$	\$	\$	\$	\$	\$	\$	\$

27. PROPERTY RECOVERED: LOCALLY _____ OTHER JURISDICTION _____ (INSERT O OR L)

PROPERTY ITEMIZATION	PROPERTY STOLEN/RECOVERED ITEMIZATION, USE THE FOLLOWING FORMAT				
	28. QUANTITY	29. ARTICLE NAME	30. BRAND NAME	31. SERIAL NUMBER	
					S <input type="checkbox"/> R <input type="checkbox"/>
					S <input type="checkbox"/> R <input type="checkbox"/>
					S <input type="checkbox"/> R <input type="checkbox"/>
					S <input type="checkbox"/> R <input type="checkbox"/>

33. PROPERTY DAMAGE AMOUNT \$ _____ 34. INSURANCE COMPANY _____

35. OFFICER ASSAULTED Y N 36. ARSON Y N 37. STRUCTURE CODE _____ 38. DAMAGE \$ _____

47. CIB ENTERED CANCELLED
 NCIC
 OTHER BROADCAST

48. TOTAL AMOUNT PROPERTY STOLEN \$ _____
 49. TOTAL AMOUNT PROPERTY RECOVERED \$ _____

50. IS REPORT CONTINUED? YES NO

51. CAUTION INDICATORS, ATLS ETC.

52. DATA PROCESS INFORMATION:
 COMPUTER ENTERED DATE 3/8/99
 MICROFILM INDEXED INITIAL KS
 IS CASE CLASSIFICATION CORRECT? Y N
 IF N HAS CORRECTION BEEN MADE? Y N

53. FILE APPROVAL
 BY [Signature] DATE 03/08/99

1. CASE # S99 No 01586 2. CLASSIFICATION 1a3011 3. CENSUS 58900

4. INCIDENT 05/599-00242

5. INCIDENT LOCATION 7 Green Bay

NAME LAST-FIRST-MI J. D.O.B. Anon.

8. ADDRESS 9. TX-HOME

11. CITY STATE ZIP 10. TX-BUSINESS

12. DETAILS
 On 2/7/99 a friend asked
 caller to drive damaged
 Blazer to G.B. because
 owner has no d.l.

8721
667600

MANITOWOC COUNTY SHERIFF
INCIDENT CARD

18. ASSIGNED
 Shaeser 4/17
 Surman 4/17
 9/219

19. REC. BY 920 20. DIS. BY
 21. HOW REC'D.
 1. 911
 2. POLICE RADIO
 3. PHONE
 4. TTY
 5. IN PERSON
 6. ON VIEW
 7. OFF. OFF. DUTY
 8. C.B. RADIO
 9. OTHER
 21A. M.O.

22. TYPE OF REPORT
 1. INCIDENT
 2. ACCIDENT
 3. CITATION
 4. NONE

23. STATUS
 1. UNFOUNDED
 2. PNL
 3. OTHER
 4. CLEARED
 5. EXCEPT CLEARED

24. DATE CLEARED 03/08/99

25. OFFENSE TYPE
 1. ADULT NA
 2. JUVENILE
 3. UNKNOWN

14. REC'D	15. DISP	16. 10-23	17. 10-24
13. DAY			
SUN 1	THU 5		
MON 2	FRI 6		
TUE 3	SAT 7		
WED 4			

39. (CODE S-SUSPECT W-WITNESS V-VICTIM O-OTHER)	40. NAME-LAST	FIRST	MI	41. D.O.B.	42. ADDRESS	43. TELEPHONE
0	[REDACTED]	[REDACTED]	173945	[REDACTED]	[REDACTED]	[REDACTED]
0	CAMACHO	FRANCISCO	175618	[REDACTED]	Washington St. Manitowoc	[REDACTED]
0	FRIAS	FERNANDO CASTRO	176428	NMI*	University Ave. Green Bay 54302	[REDACTED]

02/24/99 @ 1130 Hrs.: MTSO was notified by TRPD that a young lady, [REDACTED], just walked into their dept. with information on the hit and run accident (S99-00242). Deputy Glaeser responded and spoke with [REDACTED]

[REDACTED] stated she works at SUBWAY in Two Rivers. When officers came in today and posted the reward poster, she looked at the trucks listed, and it jogged her memory. [REDACTED] said, on Sunday (02/07/99), she was asked for a favor by some of [REDACTED], FRANCISCO and ANGELICA CAMACHO. The CAMACHOS asked her to help them out and drive a vehicle to Green Bay for one of their friends. They explained their friend had been involved in a hit and run accident and had no DL. They were asking for her to please drive the truck to Green Bay for them. FRANCISCO would follow her and give her a ride back.

[REDACTED] agreed to help them out and picked up the vehicle outside of 3 AMIGOS RESTAURANT which is owned and operated by the CAMACHOS and located on Washington St, Manitowoc. The vehicle involved was believed to have been a light brown Chevrolet Suburban with front end damage, a cracked windshield, and a passenger side door window broken out. The passenger window was covered with plastic in the absence of glass.

[REDACTED] said she drove the car to Green Bay, taking all back roads, and was accompanied by one of FRANCISCO'S friends who told her where to drive. When the parties arrived in Green Bay, [REDACTED] was instructed to park the car along a big white house on University Ave. She described the location as near LINDY'S FOOD STORE & LAUNDROMAT, just past trailer parks on the same side of the street as the trailer parks. [REDACTED] said, after she parked the truck, another part at the residence re-parked it next to the house with the damage side facing away from the street.

[REDACTED] also said she did not hear anything about the hit and run prior to seeing the poster and when she saw it posted at work, she talked to her boss, and he told her to come forward with this information.

[REDACTED] said she heard from friends after the truck moving incident that the truck was not involved in a rollover, but friends would not say exactly what happened to cause the

CASE # S99 No 01586

45. IF COMPLAINANT DIFFERENT THEN CALLER, ENTER NAME, ADDRESS, D.O.B., TELEPHONE.

46. IF CODE O (OTHER) IS USED IN FIELD #39, EXPLAIN.

INCIDENT REPORT: NOTE: IF SECTION 22 ABOVE HAS NUMBER 4 CHECKED, DO NOT GO BEYOND THIS LINE WITHOUT RECORDS SECTION BEING ADVISED, OR NO RECORD ENTRIES WILL BE MADE BELOW THIS LINE.

PROPERTY VALUE	26. PROPERTY	A. CURRENCY	B. JEWELRY	C. FURS CLOTHING	D. VEHICLE (LOCAL)	E. OFFICE EQUIPMENT	F. RADIO, TV CAMERAS	G. FIREARMS	H. HOUSE-HOLD GOODS
	STOLEN	\$	\$	\$	\$	\$	\$	\$	\$
	RECOVERED	\$	\$	\$	\$	\$	\$	\$	\$
	26. PROPERTY	I. CONSUMABLES	J. LIVESTOCK	K. DRUGS	L. MARINE ITEMS	M. CONSTRUCTION ITEMS	N. LAWN AND GARDEN	O. SPORTING GOODS	P. MISC BICYCLE
	STOLEN	\$	\$	\$	\$	\$	\$	\$	\$
	RECOVERED	\$	\$	\$	\$	\$	\$	\$	\$

27. PROPERTY RECOVERED: LOCALLY _____ OTHER JURISDICTION _____ (INSERT O OR L)

PROPERTY ITEMIZATION	PROPERTY STOLEN/RECOVERED ITEMIZATION, USE THE FOLLOWING FORMAT				31. SERIAL NUMBER	32. CODE	
	28. QUANTITY	29. ARTICLE NAME	30. BRAND NAME				
							S R
							<input type="checkbox"/> <input type="checkbox"/>
							S R
							<input type="checkbox"/> <input type="checkbox"/>
				S R			
				<input type="checkbox"/> <input type="checkbox"/>			
				S R			
				<input type="checkbox"/> <input type="checkbox"/>			

33. PROPERTY DAMAGE AMOUNT \$ _____ 34. INSURANCE COMPANY _____

35. OFFICER ASSAULTED Y N 36. ARSON Y N 37. STRUCTURE CODE _____ 38. DAMAGE \$ _____

47. CIB ENTERED CANCELLED
 NCIC
 OTHER BROADCAST

48. TOTAL AMOUNT PROPERTY STOLEN \$ _____
 49. TOTAL AMOUNT PROPERTY RECOVERED \$ _____

50. IS REPORT CONTINUED? YES NO

51. CAUTION INDICATORS, ATLS ETC.

52. DATA PROCESS INFORMATION:

COMPUTER ENTERED DATE
 MICROFILM INDEXED INITIAL _____

53. FILE APPROVAL

IS CASE CLASSIFICATION CORRECT? Y N
 IF N HAS CORRECTION BEEN MADE? Y N

BY  DATE 03/08/89

MANITOWOC COUNTY SHERIFF'S DEPARTMENT
FOLLOW-UP REPORT

Page: 2

CASE NUMBER: 399-015810 CLASSIFICATION: _____

INCIDENT: _____

DATE AND TIME: _____

REPORT CONTINUED: _____

damage. [redacted] also said she wished to remain anonymous and hoped the CAMACHOS would not know she came forward with the information.

She also said FRANCISCO works at JAGEMANN PLATING, 2nd shift (from 1100-2100 hours), and his address is [redacted] Washington St, Manitowoc, phone of [redacted]. [redacted] also drew a map as to the location of the vehicle on University Ave, Green Bay.

02/24/99 @ 1315 Hrs.: I, Lt. M. Bushman, made contact with Officer Wickmann of GBPD. I gave him the information passed on from Deputy Glaeser. As I described the location while reading the map, he advised he was familiar with the area and knew there were a large number of Hispanics living there. He knew exactly which house to go to and check for the vehicle and did so shortly after our conversation. Within an hour, he phoned back to MTSO stating that the vehicle in question was not there at this time; however, he stated he would forward the information to the following shift to make sure officers would continue checking the residence throughout the next 24 hours.

02/24/99 @ 1500 Hrs.: Telephone conversation was held with Capt. Randy Ammerman from TRPD. He was present with Deputy Glaeser on the initial contact with [redacted]. He now received a phone call from ANGELA CAMACHO. Apparently, [redacted] felt very bad about giving the information to the police and then went to the CAMACHOS and was crying hysterically. When they asked what the problem was, she gave them the information she told Deputy Glaeser and TRPD officers. ANGELA then called Capt. Ammerman and offered any assistance in attempting to locate the vehicle in question.

When questioned about the vehicle and in greater detail, ANGELA stated the vehicle we were looking for was a brown Ford Bronco which was involved in a rollover accident on I-43 near Newton Rd. The vehicle was then towed by Hi-Way 42 Garage. It remained in Hi-Way 42 Garage's possession until approximately 02/06/99.

02/24/99 @ 1515 Hrs.: Contact was made with MIKE KNORR from Hi-Way 42 Garage. The information about this complaint was relayed to him. He stated, "I do remember the vehicle. It definitely was a Ford Bronco, and it stayed with me until about February 6. At that time, a female called and wished to have the vehicle repaired to the point where it would be driveable." MIKE told her he did not have time to get at the vehicle immediately, and Ruzek's wrecker was sent to pick it up. The wrecker bill was paid, and the vehicle was towed away by Ruzek's. The vehicle in question definitely was a Ford Bronco II, and it was involved in a rollover at Newton Rd.

Subsequent check of MTSO records showed accident report #5822907 written on 02/04/99 involving FERNANDO CASTRO FRIAS, the driver of the vehicle involved. The vehicle was a 1989 Ford Bronco truck. It was towed to Hi-Way 42 Garage. Copy of the front page of the accident report is attached to this complaint.

No further follow-up. Close out complaint. MJBushman  /bjc

4241

02/24/99 @ 1125 Hrs I Deputy Glacier spoke to [REDACTED] at TRPD ref our hit and run. [REDACTED] told me that she works at The Subway in IR and when officers came in today and posted the reward poster she looked at the trucks listed and it "jogged her memory".

[REDACTED] said that on Sunday Feb 07, 1999 she was asked for a favor by [REDACTED] (Francisco and Angela Comacho) The Comacho's asked her to help them out and drive a vehicle to Green Bay for one of their friends. They explained that their friend had been involved in a hit and run accident and had no drivers license so could she please drive the truck up to Green Bay for them and Francisco would follow her and give her a ride back.

[REDACTED] agreed to help them out and picked the vehicle up outside of 3 Amigos Restaurant which is owned and operated by the Comachos and located on Washington Street in Manitowoc. The vehicle was a light Brown Chevy Suburban with front end damage, a cracked windshield and passenger side door window broken out. The passenger window was covered with plastic in the absence of glass.

[REDACTED] said she drove the car to Green Bay taking all back roads and was accompanied by one of Francisco's friends that told her where to drive. When the parties arrived in Green Bay [REDACTED] was instructed to park the car along a big white house on University ave. She described the location as near Lindy's food store and a Laundromat, just past the trailer parks and on the same side of the street as the trailer parks. [REDACTED] said after she parked the truck another party at the residence reparked it next to the house with the damaged right side facing away from the street.

[REDACTED] also said she didn't hear anything about the hit and run prior to seeing the poster and when she saw it posted at work she talked to her boss and he told her to come forward with the information.

The informant also said that she had heard from friends after the truck moving incident that the truck wasnt involved in a rollover but the friends would say exactly what happened to cause the damage.

[REDACTED] also said she wished to remain anonymous and hoped Comacho would not know she came forward with the info.

She also said that Francisco works at Jageman Plating second shift from 11am to 9pm and his address is [REDACTED] Washington Street with a phone number of [REDACTED]

[REDACTED] info is as follows [REDACTED]

[REDACTED] also drew a map as to the location of the vehicle on University Ave in Green Bay.

S99-01586

OFF. WICKMANN
G.P.A. S99-01586
02 24 99
1315 HWS

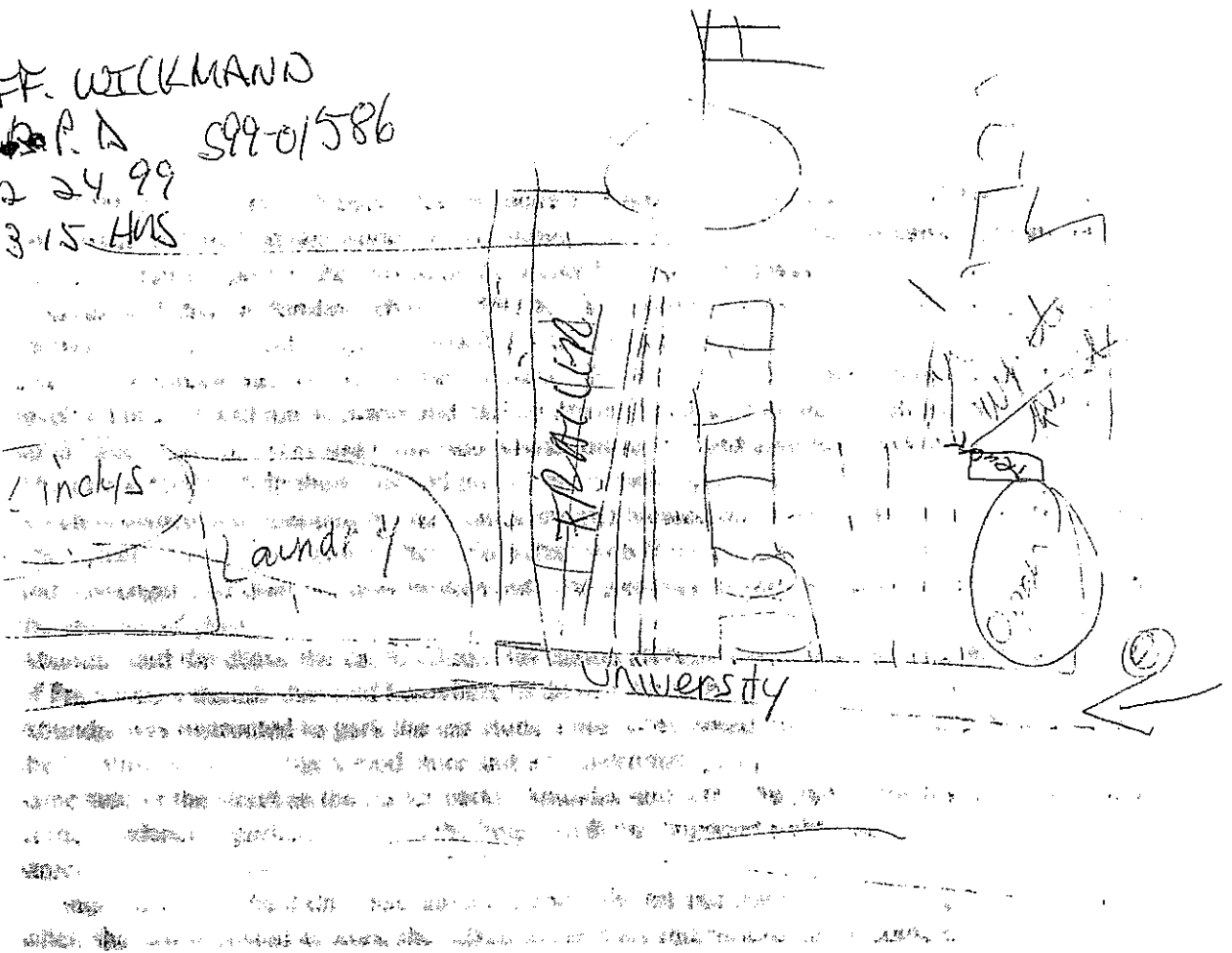

Subway: 10001

0
WORELS RT - Seaboard
8 April - 11.

WASHINGT
ST.

28 4/03
0210

[Faint, mostly illegible text and markings, possibly bleed-through from the reverse side of the page.]

3 Amigos [redacted] Washington St
went there at 0900

- wasn't there ^{with} before

- took back roads to B.

- when parked, person
turned it around so as

not to be seen from
street

- ASKED TO DROP OFF
TRACK AS NO ONE HAD

ON 02-06-99 AT 9-10AM FRANCISCO
COMACHO CALLED [REDACTED] + ASKED HER
TO DRIVE BROWN BLAZER WITH DAMAGE
TO GREEN BAY. PARKED IT AT RESIDENCE
NEXT TO TRAILER PARK OFF UNIVERSITY

SUNDAY MORNING -

drove from 3 AMIGOS TO GREEN BAY
WITH BLAZER - TOOK BACK ROADS AND ^{WERE} PARAD
FRANCISCO WORKS AT JAGEMAN ^{TO SHOW POLICE} PLATING
& RUNS 3 AMIGOS ON WASHINGTON STREET
ANOTHER PERSON TURNED THE TRUCK
AROUND AND PARKED IT DAMAGE SIDE
AWAY FROM ROAD -

~~[REDACTED]~~



5822907

Documented Document On Emergency

Document Number Override

Wisconsin Motor Vehicle Accident Report

Please Do Not Write in This Margin Space

INSTRUCTIONS
Please use a Black Ink Pen or #2 Pencil.

Mark Areas as shown:
Correct Mark:

Incorrect Marks:

Reportable Accident: N

County	36	MUN/TWP	4
0	0	0	0
1	1	1	1
2	2	2	2
3	3	3	3
4	4	4	4
5	5	5	5
6	6	6	6
7	7	7	7
8	8	8	8
9	9	9	9

Accident Date		
MONTH	DAY	YEAR
Jan	04	99
Feb		
Mar		
Apr		
May		
June		
July		
Aug		
Sept		
Oct		
Nov		
Dec		

Time of Accident (Military Time)	
HOUR	MIN.
05	58
0	0
1	1
2	2
3	3
4	4
5	5
6	6
7	7
8	8
9	9

Total Number		
UNITS	INJURED	KILLED
0	0	0
1	1	1
2	2	2
3	3	3
4	4	4
5	5	5
6	6	6
7	7	7
8	8	8
9	9	9

Hit & Run	<input checked="" type="checkbox"/>
Government Property	<input checked="" type="checkbox"/>
Fire (Narrative)	<input checked="" type="checkbox"/>
Photos Taken (Narrative)	<input checked="" type="checkbox"/>
Trailer or Towed (Narrative)	<input checked="" type="checkbox"/>
Truck or Bus (Last Page)	<input checked="" type="checkbox"/>
Load Spillage	<input checked="" type="checkbox"/>
Construction Zone	<input checked="" type="checkbox"/>
Names Exchanged	<input checked="" type="checkbox"/>

Sheet No. Of
12

ACCIDENT LOCATION

Public Highway, Intersection/Related
 Public Highway, Non-Intersection
 Parking Lot
 Private Property or Road

LATITUDE (GPS) Degrees: 11			LONGITUDE (GPS) Degrees: 13		
Minutes:	Seconds:	Minutes:	Seconds:	Minutes:	Seconds:
04	14	04	14	04	14

ON	Hwy No. and / Street Name	Estimated	FROM/AT	Hwy No. and / Street Name
14	I-43	.4	16	MM 143

Unit Number	Unit Type	Total Number of Occupants	Direction of Travel (Before the Accident)	Unit Number	Unit Type	Total Number of Occupants	Direction of Travel (Before the Accident)
2	3	4	(N)	2	3	4	(N)

Operator Last Name	First	M.I.	Operator Last Name	First	M.I.
FRIAS	FERNANDO	CASTRO	NMI		

Address - Street & Number	City & State	ZIP	Phone Number	Address - Street & Number	City & State	ZIP	Phone Number
26 UNIVERSITY AVE	GREEN BAY WI	54302	(920)	26 UNIVERSITY AVE	GREEN BAY WI	54302	(920)

Date of Birth	Sex	Operating as	Classified	Date of Birth	Sex	Operating as	Classified
	F	CMV	Y		F	CMV	Y

Severity	SEAT Position	SAFETY Equipment	AIRBAG	Severity	SEAT Position	SAFETY Equipment	AIRBAG
(A)	1	1	1	(A)	1	1	1

TRAPPED/ EXTRICATED	Medical Transport	TRAPPED/ EXTRICATED	Medical Transport
1	1	1	1

Vehicle Owner	Last Name	First	M.I.	Vehicle Owner	Last Name	First	M.I.
45				45			

Occupant Unit Number	NAME Last	First	M.I.	Date of Birth	Sex	SEAT Position	SAFETY Equipment	AIRBAG
65	MENDOZA	RAMIRO	NMI	67		3	7	3

Address Same as Operator	EJECTED	TRAPPED/ EXTRICATED	Medical Transport	Agency Space	EMS Number
74	1	1	1	78	

Police No. 599-01040

Date

Location 14027



399 INE 00070 16.310.11 11.410.11

4. INCIDENT CS / S99-00242

5. INCIDENT LOCATION [REDACTED] CTH CR

6. NAME - LAST-FIRST-MI ANONY. (j)

7. D.O.B.

8. ADDRESS [REDACTED]

9. TX-HOME

11. CITY STATE ZIP

10. TX-BUSINESS

12. DETAILS
 Rpts. THAT RICHARD HOCHSTETLER WAS MAKING HARASSING PHONE CALLS TO FEMALE NEIGHBOR PRIOR TO ACCIDENT. MAY BE POSSIBLE THAT THIS WAS RETALIATION.

INCIDENT CARD

18. ASSIGNED MTSO 9129
HHV

19. REC. BY 938

20. DIS. BY

22. TYPE OF REPORT
 1. INCIDENT
 2. ACCIDENT
 3. CITATION
 4. NONE

21. HOW REC'D.
 1. 911
 2. POLICE RADIO
 3. PHONE
 4. TTY
 5. IN PERSON
 6. ON VIEW
 7. OFF. OFF DUTY
 8. C.B. RADIO
 9. OTHER

23. STATUS
 1. UNFOUNDED
 2. PNL
 3. OTHER
 4. CLEARED
 5. EXCEPT CLEARED

24. DATE CLEARED 03/16/99

25. OFFENSE TYPE
 1. ADULT
 2. JUVENILE
 3. UNKNOWN

21A. M.O.

14. REC'D	15. DISP	16. 10-23	17. 10-24
13. DAY			
SUN 1	THU 5		
MON 2	FRI 6		
TUE 3	SAT 7		
WED 4			

39. (CODE S-SUSPECT W-WITNESS V-VICTIM O-OTHER)	40. NAME-LAST	FIRST	MI	41. D.O.B.	42. ADDRESS	43. TELEPHONE
0	VOCKE	THOMAS	P	[REDACTED]	Silver Creek Rd, Manitowoc	[REDACTED]
0	[REDACTED]	[REDACTED]	[REDACTED]	[REDACTED]	[REDACTED]	[REDACTED]
0	[REDACTED]	[REDACTED]	[REDACTED]	[REDACTED]	[REDACTED]	[REDACTED]

JUVENILE INFO REDACTED

01-28-99 Con't... Caller had heard this from another person. Unk. what neighbor this was and only further info. was that they would live "up the hill" from Richard's house. Dispatch found nothing in-house ref. harassing phone calls. 938/KB

03/06/99: I, Lt. M. Bushman, went to the area of Silver Creek Rd and CTH CR. Following the description on the complaint of "up the hill," I began checking residences.

03/06/99 @ 1137 Hrs.: Contact was attempted at [REDACTED] CTH CR, but no one was home.

03/06/99 @ 1141 Hrs.: Contact was made at [REDACTED] Silver Creek Rd. I spoke with an older woman who lived at this residence. She stated she did not know RICK HOCHSTETLER, had no problems with him, and did not hear other neighbors having any problems with him.

03/06/99 @ 1148 Hrs.: Contact was made at [REDACTED] Silver Creek Rd, and I spoke with the residence owners. Both agreed they did not even know RICK had lived there until the incident. They knew his stepfather by the last name of WETENKAMP. As far as they knew, none of the neighbors were having any problems with him.

03/06/99 @ 1155 Hrs.: Contact was made at [REDACTED] Silver Creek Rd with THOMAS VOCKE who was putting up a new garage door opener in his garage. Shortly after, I advised him of the complaint I was working on. He stated, "Yes, she's home at this time. If you want to talk to her, feel free to." He then advised his daughter, [REDACTED], received several phone calls from RICK; however, he would hardly call them harassment.

I was escorted into the residence where I made contact with THOMAS' 16-year-old daughter, [REDACTED]. We sat at the kitchen table and had a conversation about the complaint. She stated she originally met RICK on the bus. She is a sophomore and RICK would have been a junior. She stated she received approximately 5-6 phone calls which were stretched out between 1-2 months. None of the phone calls could be considered threatening, none of them could be considered obscene. She stated it was more like a joke with her family and her friends, something to do at the time. RICK apparently called her stating "you're changing" and then made small talk to her, eventually asking her if she wanted to go out with him. She kept

45. IF COMPLAINANT DIFFERENT THEN CALLER, ENTER NAME, ADDRESS, D.O.B., TELEPHONE.

46. IF CODE O (OTHER) IS USED IN FIELD #39, EXPLAIN.

INCIDENT REPORT: NOTE: IF SECTION 22 ABOVE HAS NUMBER 4 CHECKED, DO NOT GO BEYOND THIS LINE WITHOUT RECORDS SECTION BEING ADVISED, OR NO RECORD ENTRIES WILL BE MADE BELOW THIS LINE.

PROPERTY VALUE	26. PROPERTY	A. CURRENCY	B. JEWELRY	C. FURS CLOTHING	D. VEHICLE (LOCAL)	E. OFFICE EQUIPMENT	F. RADIO, TV CAMERAS	G. FIREARMS	H. HOUSE-HOLD GOODS
	STOLEN	\$	\$	\$	\$	\$	\$	\$	\$
	RECOVERED	\$	\$	\$	\$	\$	\$	\$	\$
	26. PROPERTY	I. CONSUMABLES	J. LIVESTOCK	K. DRUGS	L. MARINE ITEMS	M. CONSTRUCTION ITEMS	N. LAWN AND GARDEN	O. SPORTING GOODS	P. MISC BICYCLE
	STOLEN	\$	\$	\$	\$	\$	\$	\$	\$
	RECOVERED	\$	\$	\$	\$	\$	\$	\$	\$

27. PROPERTY RECOVERED: LOCALLY _____ OTHER JURISDICTION _____ (INSERT O OR L)

PROPERTY ITEMIZATION	PROPERTY STOLEN/RECOVERED ITEMIZATION, USE THE FOLLOWING FORMAT				
	28. QUANTITY	29. ARTICLE NAME	30. BRAND NAME	31. SERIAL NUMBER	
					S R <input type="checkbox"/> <input type="checkbox"/>
					S R <input type="checkbox"/> <input type="checkbox"/>
					S R <input type="checkbox"/> <input type="checkbox"/>
					S R <input type="checkbox"/> <input type="checkbox"/>

33. PROPERTY DAMAGE AMOUNT \$ _____ 34. INSURANCE COMPANY _____

35. OFFICER ASSAULTED Y N 36. ARSON Y N 37. STRUCTURE CODE _____ 38. DAMAGE \$ _____

47. CIB	ENTERED <input type="checkbox"/>	CANCELLED <input type="checkbox"/>	48. TOTAL AMOUNT PROPERTY STOLEN \$ _____
NCIC	<input type="checkbox"/>	<input type="checkbox"/>	
OTHER BROADCAST	<input type="checkbox"/>	<input type="checkbox"/>	
			49. TOTAL AMOUNT PROPERTY RECOVERED \$ _____

50. IS REPORT CONTINUED? YES NO 51. CAUTION INDICATORS, ATLS ETC.

52. DATA PROCESS INFORMATION:

COMPUTER ENTERED DATE 13/11/99

MICROFILM INDEXED INITIAL KS

IS CASE CLASSIFICATION CORRECT? Y N
IF N HAS CORRECTION BEEN MADE? Y N

53. FILE APPROVAL

BY [Signature] DATE 03/6/99

MANITOWOC COUNTY SHERIFF'S DEPARTMENT
FOLLOW-UP REPORT

Page: 2

CASE NUMBER: 598-00878 CLASSIFICATION: _____

INCIDENT: _____

DATE AND TIME: _____

REPORT CONTINUED:

turning him down and eventually began to complain about the phone calls to a friend of hers, [REDACTED], who advised RICK to stop making the calls. I inquired as to whether the phone calls stopped. She stated he would listen after a while, he just had to be told a few times. The phone calls were made to her residence in early spring 1998, lasting for about 2 months, and then ended. She again stated none of them were threatening, she just did not wish to go out with him.

[REDACTED] stated she has heard several rumors, one of them being that perhaps RICK'S ex-girlfriend may have done this to him. She stated, "I didn't even know he had a girlfriend." [REDACTED] stated all the rumors she heard were very shortly after the accident and she has not heard any since.

03/06/99 @ 1220 Hrs.: Attempted to make contact at [REDACTED] Silver Creek Rd. No one was home.

03/06/99 @ 1235 Hrs.: Contact was made with [REDACTED], Cleveland. RICK used to live close to the [REDACTED] farm at the intersection of CTH X and Center Rd, before moving to CTH CR. [REDACTED] stated, "RICK was my friend. He used to call and talk. He didn't harass me. He called [REDACTED] a few times. She told me twice. They met and talked on the bus." [REDACTED] stated she heard rumors at LINCOLN HIGH SCHOOL that the guy who did it is from Newton; however, she did not recall any specific name.

As we talked and I asked more questions about RICK, [REDACTED] eyes started filling with tears, and she began to cry. She repeated that RICK was her friend, and the interview was stirring up old memories. [REDACTED] did not have any more information to add. The conversation was terminated.

Unless we receive more information on this complaint with specific details, I believe this matter can be closed. MJBush *[Signature]* /bjc

JUVENILE INFO REDACTED

1. CASE # S99 No 01751		2. CLASSIFICATION 6.310.11		3. CENSUS 5.110.00		MANITOWOC COUNTY SHERIFF INCIDENT CARD							
4. INCIDENT CS / S99-00242												18. ASSIGNED Bushman	
5. INCIDENT LOCATION KIEL						19. REC. BY 938							
6. NAME - LAST - FIRST - MI ANONG				7. D.O.B.								20. DIS. BY	
8. ADDRESS				9. TX-HOME		21. HOW REC'D. 3 1. 911 2. POLICE RADIO 3. PHONE 4. TTY 5. IN PERSON 6. ON VIEW 7. OFF OFF DUTY 8. C.B. RADIO 9. OTHER		23. STATUS 3 1. UNFOUNDED 2. PNL 3. OTHER 4. CLEARED 5. EXCEPT CLEARED					
11. CITY		STATE		ZIP				10. TX-BUSINESS		24. DATE CLEARED 03/08/99			
12. DETAILS See Attached.						14. REC'D		15. DISP		16. 10-23		17. 10-24	
						13. DAY SUN 1 THU 6 MON 2 FRI 6 TUE 3 SAT 7 WED 4							
						21A. M.O.							
						25. OFFENSE TYPE 1. ADULT <input type="checkbox"/> NA <input type="checkbox"/> 2. JUVENILE <input type="checkbox"/> 3. UNKNOWN <input type="checkbox"/>							

1546
03-01-99

39. (CODE S-SUSPECT W-WITNESS V-VICTIM O-OTHER)						
CODE	40. NAME-LAST	FIRST	MI	41. D.O.B.	42. ADDRESS	43. TELEPHONE
0	Mc Nitt	Truman L.	(Tim)	70888	Fremont St., Kiel, Wi.	

03/04/99 1630hrs Contact attempted at [redacted] Fremont St. Kiel. Truman L. Mc Nitt was not at home and I spoke with his son [redacted] Mc Nitt. I asked [redacted] if his father drives any vans and he stated two. Only recently was it two though because one wasn't running. [redacted] went on to tell me his father had a blue 83 Chev van that blew a radiator when it overheated in January and he was forced to park it. He then bought a marron Dodge van to drive until only recently when he repaired the 83 Chev and put it back on the road. [redacted] stated none of his father's vehicle have damage to the front.

Contact made with Sgt. Gaetke who has had several contacts with Truman. He stated Truman does drink but has never been cited for OWI. Living above the old Hotel on Fremont Street he usually walks to several bars within a block. Truman has been very straight forward with Kiel PD in past contacts, one where his son was a suspect Truman encouraged his son to be truthful and then bent over backwards to help the PD find all the information they needed to complete the complaint. Sgt. Gaetke has observed Truman's vehicles on many occasions this winter no damage to the front was noted. All listed Chev. trucks are older than the suspect vehicles. Close Out. M.J. Bushman

45. IF COMPLAINANT DIFFERENT THEN CALLER, ENTER NAME, ADDRESS, D.O.B., TELEPHONE.

46. IF CODE O (OTHER) IS USED IN FIELD #39, EXPLAIN.

INCIDENT REPORT: NOTE: IF SECTION 22 ABOVE HAS NUMBER 4 CHECKED, DO NOT GO BEYOND THIS LINE WITHOUT RECORDS SECTION BEING ADVISED, OR NO RECORD ENTRIES WILL BE MADE BELOW THIS LINE.

PROPERTY VALUE	26. PROPERTY	A. CURRENCY	B. JEWELRY	C. FURS CLOTHING	D. VEHICLE (LOCAL)	E. OFFICE EQUIPMENT	F. RADIO, TV CAMERAS	G. FIREARMS	H. HOUSE-HOLD GOODS
	STOLEN	\$	\$	\$	\$	\$	\$	\$	\$
	RECOVERED	\$	\$	\$	\$	\$	\$	\$	\$
	26. PROPERTY	I. CONSUMABLES	J. LIVESTOCK	K. DRUGS	L. MARINE ITEMS	M. CONSTRUCTION ITEMS	N. LAWN AND GARDEN	O. SPORTING GOODS	P. MISC BICYCLE
	STOLEN	\$	\$	\$	\$	\$	\$	\$	\$
	RECOVERED	\$	\$	\$	\$	\$	\$	\$	\$

27. PROPERTY RECOVERED: LOCALLY _____ OTHER JURISDICTION _____ (INSERT O OR L)

PROPERTY ITEMIZATION	PROPERTY STOLEN/RECOVERED ITEMIZATION, USE THE FOLLOWING FORMAT				
	28. QUANTITY	29. ARTICLE NAME	30. BRAND NAME	31. SERIAL NUMBER	32. CODE
					S <input type="checkbox"/> R <input type="checkbox"/>
					S <input type="checkbox"/> R <input type="checkbox"/>
					S <input type="checkbox"/> R <input type="checkbox"/>
					S <input type="checkbox"/> R <input type="checkbox"/>
					S <input type="checkbox"/> R <input type="checkbox"/>

33. PROPERTY DAMAGE AMOUNT \$ _____

34. INSURANCE COMPANY _____

35. OFFICER ASSAULTED Y N

36. ARSON Y N

37. STRUCTURE CODE _____

38. DAMAGE \$ _____

47. CIB ENTERED CANCELLED
 NCIC
 OTHER BROADCAST

48. TOTAL AMOUNT PROPERTY STOLEN \$ _____

49. TOTAL AMOUNT PROPERTY RECOVERED \$ _____

50. IS REPORT CONTINUED? YES NO

51. CAUTION INDICATORS, ATLS ETC.

52. DATA PROCESS INFORMATION:

COMPUTER ENTERED DATE 3/5/99
 MICROFILM INDEXED INITIAL AS

53. FILE APPROVAL

IS CASE CLASSIFICATION CORRECT? Y N
 IF N HAS CORRECTION BEEN MADE? Y N

BY [Signature] DATE 030899

1. CASE # S99 No 01753 2. CLASSIFICATION 0.310.11 3. CENSUS 601000

4. INCIDENT CS / 599-00242
 INCIDENT LOCATION EAST SB 43 OFF STH 151

6. NAME FIRST-MI NY (2) 7. D.O.B.

8. ADDRESS TX-HOME

11. CITY STATE ZIP 10. TX-BUSINESS

12. DETAILS See Attached.

1024
 03-01-99
 14. REC'D 15. DISP 16. 10-23 17. 10-24
 13. DAY
 SUN 1 THU 5
 MON 2 FRI 6
 TUE 3 SAT 7
 WED 4

MANITOWOC COUNTY SHERIFF
 INCIDENT CARD

18. ASSIGNED Bushman 8141
 9249

19. REC. BY 935 20. DIS. BY

22. TYPE OF REPORT
 1. INCIDENT
 2. ACCIDENT
 3. CITATION
 4. NONE

21. HOW REC'D.
 1. 911
 2. POLICE RADIO
 3. PHONE
 4. TTY
 5. IN PERSON
 6. ON VIEW
 7. OFF. OFF DUTY
 8. C.B. RADIO
 9. OTHER

23. STATUS
 1. UNFOUNDED
 2. PNL
 3. OTHER
 4. CLEARED
 5. EXCEPT CLEARED

24. DATE CLEARED 03 08 99

25. OFFENSE TYPE
 1. ADULT NA
 2. JUVENILE
 3. UNKNOWN

39. (CODE S-SUSPECT W-WITNESS V-VICTIM O-OTHER)						
CODE	40. NAME-LAST	FIRST	MI	41. D.O.B.	42. ADDRESS	43. TELEPHONE
0	Milbauer, Michael A.			176290	Sauk Trl Rd Cedar Grove	

03/03/99 1120hrs Contact made by phone with Complainant. He stated he saw the suspect vehicle at the Holiday Inn intersection and sped up to see the grill. When he saw the damage he fell back and got a plate. Vehicle turned South onto I-43. Veh. is a dull gray color with real wide tires, Silverado addition of blazer. Comp. unsure how much of the grill was still in place, stating "This probably is not the vehicle, but I thought it should be checked."

Attempted contact by phone with Milbauer residence in Cedar Grove, no answer. M.J. Bushman

03/04/99 1001hrs Contact attempted by phone and message left to call me back. M.J. Bushman

03/04/99 1651hrs Milbauer called back stating he does own an 85 Chev Blazer and since Feb. 16 has held a job a Burger Boat Co., Manitowoc. The blazer was bought in 09/98 and sat at a garage until 01/99 having a motor change from 305 Cu in to 350 Cu in.. Milbauer helped the mechanic and work would only be done when money was paid upfront. Vehicle was completed 01/99 and then sat until 02/99 when emissions passed the test and registration was then applied for. Damage is to the drivers side of the grille, no hood or sheet metal damage. This is a full size Silverado edition with the four headlamps. Damage was on the vehicle when purchased. This is not the suspect vehicle, close out. M.J. Bushman

45. IF COMPLAINANT DIFFERENT THEN CALLER, ENTER NAME, ADDRESS, D.O.B., TELEPHONE.

46. IF CODE O (OTHER) IS USED IN FIELD #39, EXPLAIN.

INCIDENT REPORT: NOTE: IF SECTION 22 ABOVE HAS NUMBER 4 CHECKED, DO NOT GO BEYOND THIS LINE WITHOUT RECORDS SECTION BEING ADVISED, OR NO RECORD ENTRIES WILL BE MADE BELOW THIS LINE.

PROPERTY VALUE	26. PROPERTY	A. CURRENCY	B. JEWELRY	C. FURS CLOTHING	D. VEHICLE (LOCAL)	E. OFFICE EQUIPMENT	F. RADIO, TV CAMERAS	G. FIREARMS	H. HOUSEHOLD GOODS
	STOLEN	\$	\$	\$	\$	\$	\$	\$	\$
	RECOVERED	\$	\$	\$	\$	\$	\$	\$	\$
	26. PROPERTY	I. CONSUMABLES	J. LIVESTOCK	K. DRUGS	L. MARINE ITEMS	M. CONSTRUCTION ITEMS	N. LAWN AND GARDEN	O. SPORTING GOODS	P. MISC BICYCLE
STOLEN	\$	\$	\$	\$	\$	\$	\$	\$	
RECOVERED	\$	\$	\$	\$	\$	\$	\$	\$	

27. PROPERTY RECOVERED: LOCALLY _____ OTHER JURISDICTION _____ (INSERT O OR L)

PROPERTY ITEMIZATION	PROPERTY STOLEN/RECOVERED ITEMIZATION, USE THE FOLLOWING FORMAT				
	28. QUANTITY	29. ARTICLE NAME	30. BRAND NAME	31. SERIAL NUMBER	
					S <input type="checkbox"/> R <input type="checkbox"/>
					S <input type="checkbox"/> R <input type="checkbox"/>
					S <input type="checkbox"/> R <input type="checkbox"/>
					S <input type="checkbox"/> R <input type="checkbox"/>

33. PROPERTY DAMAGE AMOUNT \$ _____ 34. INSURANCE COMPANY _____

35. OFFICER ASSAULTED Y N 36. ARSON Y N 37. STRUCTURE CODE _____ 38. DAMAGE \$ _____

47. CIB ENTERED CANCELLED
 NCIC
 OTHER BROADCAST

48. TOTAL AMOUNT PROPERTY STOLEN \$ _____
 49. TOTAL AMOUNT PROPERTY RECOVERED \$ _____

50. IS REPORT CONTINUED? YES NO

51. CAUTION INDICATORS, ATLS ETC.

52. DATA PROCESS INFORMATION:
 COMPUTER ENTERED DATE 3.8.99
 MICROFILM INDEXED INITIAL KS
 IS CASE CLASSIFICATION CORRECT? N
 IF N HAS CORRECTION BEEN MADE? N

53. FILE APPROVAL
 BY [Signature] DATE 030899

1. CASE # S99 No 01783 2. CLASSIFICATION 630.11 3. CENSUS 1410.11

4. INCIDENT CS/S99-00242

5. INCIDENT-LOCATION

6. NAME - LAST-FIRST-MI Anon 7. D.O.B.

8. ADDRESS 9. TX-HOME

11. CITY STATE ZIP 10. TX-BUSINESS

12. DETAILS Caller states he saw a vehicle at Fleet Farm

Blue & White in color. 83 GMC tk with

a new/different grill. RP #KCA602

13:06 3-2-99

MANITOWOC COUNTY SHERIFF INCIDENT CARD

18. ASSIGNED MTSO 929
441

19. REC. BY 926 20. DIS. BY
22. TYPE OF REPORT
1. INCIDENT
2. ACCIDENT
3. CITATION
4. NONE

21. HOW REC'D.
1. 911
2. POLICE RADIO
3. PHONE
4. TTY
5. IN PERSON
6. ON VIEW
7. OFF. OFF DUTY
8. C.B. RADIO
9. OTHER

23. STATUS
1. UNFOUNDED
2. PNL
3. OTHER
4. CLEARED
5. EXCEPT CLEARED

24. DATE CLEARED 03/08/99
25. OFFENSE TYPE
1. ADULT NA
2. JUVENILE
3. UNKNOWN

14. REC'D
15. DISP
16. 10-23
17. 10-24
13. DAY
SUN 1 THU 5
MON 2 FRI 6
TUE 3 SAT 7
WED 4

39. (CODE S-SUSPECT W-WITNESS V-VICTIM O-OTHER)

CODE	40. NAME-LAST	FIRST	MI	41. D.O.B.	42. ADDRESS	43. TELEPHONE

03/04/99 1212hrs Contact made with TRPD and request made to attempt contact with suspect vehicle. It will be assigned. M.J. Bushman

03/05/99 1519hrs Check with TRPD, vehicle checked and not a suspect vehicle report will follow. Close out. M.J. Bushman

M
S
A
T
U
R
D
A
Y

CIB
INCIC
IHTO
IS RE
ATA

18 CASE
15 M HA

S99 No 01783

45. IF COMPLAINANT DIFFERENT THEN CALLER, ENTER NAME, ADDRESS, D.O.B., TELEPHONE.

46. IF CODE O (OTHER) IS USED IN FIELD #39, EXPLAIN.

INCIDENT REPORT: NOTE: IF SECTION 22 ABOVE HAS NUMBER 4 CHECKED, DO NOT GO BEYOND THIS LINE WITHOUT RECORDS SECTION BEING ADVISED, OR NO RECORD ENTRIES WILL BE MADE BELOW THIS LINE.

PROPERTY VALUE	25. PROPERTY	A. CURRENCY	B. JEWELRY	C. FURS CLOTHING	D. VEHICLE (LOCAL)	E. OFFICE EQUIPMENT	F. RADIO, TV CAMERAS	G. FIREARMS	H. HOUSE-HOLD GOODS
	STOLEN	\$	\$	\$	\$	\$	\$	\$	\$
	RECOVERED	\$	\$	\$	\$	\$	\$	\$	\$
	26. PROPERTY	I. CONSUMABLES	J. LIVESTOCK	K. DRUGS	L. MARINE ITEMS	M. CONSTRUCTION ITEMS	N. LAWN AND GARDEN	O. SPORTING GOODS	P. MISC BICYCLE
STOLEN	\$	\$	\$	\$	\$	\$	\$	\$	
RECOVERED	\$	\$	\$	\$	\$	\$	\$	\$	

27. PROPERTY RECOVERED: LOCALLY _____ OTHER JURISDICTION _____ (INSERT O OR L)

PROPERTY ITEMIZATION	PROPERTY STOLEN/RECOVERED ITEMIZATION, USE THE FOLLOWING FORMAT				31. SERIAL NUMBER	32. CODE
	28. QUANTITY	29. ARTICLE NAME	30. BRAND NAME			
						S <input type="checkbox"/> R <input type="checkbox"/>
						S <input type="checkbox"/> R <input type="checkbox"/>
						S <input type="checkbox"/> R <input type="checkbox"/>
						S <input type="checkbox"/> R <input type="checkbox"/>
						S <input type="checkbox"/> R <input type="checkbox"/>
						S <input type="checkbox"/> R <input type="checkbox"/>

33. PROPERTY DAMAGE AMOUNT \$ _____ 34. INSURANCE COMPANY _____

35. OFFICER ASSAULTED Y N 36. ARSON Y N 37. STRUCTURE CODE _____ 38. DAMAGE \$ _____

47. GIB NCIC OTHER BROADCAST	ENTERED <input type="checkbox"/>	CANCELLED <input type="checkbox"/>	48. TOTAL AMOUNT PROPERTY STOLEN \$ _____	
	<input type="checkbox"/>	<input type="checkbox"/>		49. TOTAL AMOUNT PROPERTY RECOVERED \$ _____
	<input type="checkbox"/>	<input type="checkbox"/>		

50. IS REPORT CONTINUED? YES NO 51. CAUTION INDICATORS, ATLS ETC.

52. DATA PROCESS INFORMATION:

COMPUTER ENTERED DATE 3/8/99
 MICROFILM INDEXED INITIAL JS

IS CASE CLASSIFICATION CORRECT? N
 IF N HAS CORRECTION BEEN MADE? N

53. FILE APPROVAL
 BY [Signature] DATE 3/8/99

1. CASE # S99 No 01788 2. CLASSIFICATION 630.1 3. CENSUS 521000

4. INCIDENT # 599-00292 INCIDENT LOCATION

6. NAME- LAST-FIRST-MI 7. D.O.B.

8. ADDRESS 9. TX-HOME

11. CITY STATE ZIP 10. TX-BUSINESS

12. DETAILS
SAW BLAZER WITH GRILL DAMAGE
PULLED IN [REDACTED] BLK MICHIGAN AVE.

1507
3-2-99

14. REC'D	15. DISP	16. 10-23	17. 10-24
13. DAY			
SUN 1	THU 5		
MON 2	FRI 6		
TUE 3	SAT 7		
WED 4			

MANITOWOC COUNTY SHERIFF
INCIDENT CARD

18. ASSIGNED
MUTSO 912A
4411

19. REC. BY 932 20. DIS. BY 932
21. HOW REC'D.
1. 911
2. POLICE RADIO
3. PHONE
4. TTY
5. IN PERSON
6. ON VIEW
7. OFF. OFF DUTY
8. C.B. RADIO
9. OTHER
21A. M.O.

22. TYPE OF REPORT
1. INCIDENT
2. ACCIDENT
3. CITATION
4. NONE
23. STATUS
1. UNFOUNDED
2. PNL
3. OTHER
4. CLEARED
5. EXCEPT CLEARED

24. DATE CLEARED 103116199
25. OFFENSE TYPE
1. ADULT NA
2. JUVENILE
3. UNKNOWN

39. (CODE S-SUSPECT W-WITNESS V-VICTIM O-OTHER)

CODE	40. NAME-LAST	FIRST	MI	41. D.O.B.	42. ADDRESS	43. TELEPHONE
0	Dobbs, Robert A.			[REDACTED]	[REDACTED] E. River St. Two Rivers	[REDACTED]

03/04/99 1226hrs Contact made with TRPD and request made to attempt contact with suspect vehicle. It will be assigned. M.J. Bushman
Vehicle was checked shortly after the accident as it was stopped by Off. Crabb on Maritime Drive per Dispatcher Lynn. She knows the owner and recognized the name while working as dispatch for Manitowoc PD. Complaint can be closed out. M.J. Bushman

MJB

PP 01 300

21

CASE # S99 No 01788

45. IF COMPLAINANT DIFFERENT THEN CALLER, ENTER NAME, ADDRESS, D.O.B., TELEPHONE.

46. IF CODE O (OTHER) IS USED IN FIELD #39, EXPLAIN.

INCIDENT REPORT: NOTE: IF SECTION 22 ABOVE HAS NUMBER 4 CHECKED, DO NOT GO BEYOND THIS LINE WITHOUT RECORDS SECTION BEING ADVISED, OR NO RECORD ENTRIES WILL BE MADE BELOW THIS LINE.

PROPERTY VALUE	26. PROPERTY	A. CURRENCY	B. JEWELRY	C. FURS CLOTHING	D. VEHICLE (LOCAL)	E. OFFICE EQUIPMENT	F. RADIO, TV CAMERAS	G. FIREARMS	H. HOUSE-HOLD GOODS
	STOLEN	\$	\$	\$	\$	\$	\$	\$	\$
	RECOVERED	\$	\$	\$	\$	\$	\$	\$	\$
	26. PROPERTY	I. CONSUMABLES	J. LIVESTOCK	K. DRUGS	L. MARINE ITEMS	M. CONSTRUCTION ITEMS	N. LAWN AND GARDEN	O. SPORTING GOODS	P. MISC BICYCLE
	STOLEN	\$	\$	\$	\$	\$	\$	\$	\$
	RECOVERED	\$	\$	\$	\$	\$	\$	\$	\$

27. PROPERTY RECOVERED: LOCALLY _____ OTHER JURISDICTION _____ (INSERT O OR L)

PROPERTY ITEMIZATION	PROPERTY STOLEN/RECOVERED ITEMIZATION, USE THE FOLLOWING FORMAT				
	28. QUANTITY	29. ARTICLE NAME	30. BRAND NAME	31. SERIAL NUMBER	32. CODE
					S R <input type="checkbox"/> <input type="checkbox"/>
					S R <input type="checkbox"/> <input type="checkbox"/>
					S R <input type="checkbox"/> <input type="checkbox"/>
					S R <input type="checkbox"/> <input type="checkbox"/>
					S R <input type="checkbox"/> <input type="checkbox"/>

33. PROPERTY DAMAGE AMOUNT \$ _____

34. INSURANCE COMPANY _____

35. OFFICER ASSAULTED Y N

36. ARSON Y N

37. STRUCTURE CODE _____

38. DAMAGE \$ _____

47. CIB ENTERED CANCELLED
 NCIC
 OTHER BROADCAST

48. TOTAL AMOUNT PROPERTY STOLEN \$ _____

49. TOTAL AMOUNT PROPERTY RECOVERED \$ _____

50. IS REPORT CONTINUED? YES NO

51. CAUTION INDICATORS, ATLS ETC.

52. DATA PROCESS INFORMATION:

COMPUTER ENTERED DATE 3/16/99

MICROFILM INDEXED INITIAL *KS*

IS CASE CLASSIFICATION CORRECT? N
 IF N HAS CORRECTION BEEN MADE? N

53. FILE APPROVAL

BY *RE*

DATE 3/16/99

TWO RIVERS POLICE CARE



599-1788

Police Department

East Park Street

Post Office Box 87

Two Rivers WI 54241-0087

EMERGENCY DIAL 911

Non-Emergency Police Response..

Police Business Office

Mon.-Fri. 7:00 am to 4:30 pm

FAX

email.....

FAX COVER SHEET

TO: MTSO / ATTN: LT. MIKE BUSHMAN
FROM: Two Rivers Police Department / LT. MIKE
SUBJECT: HOCHSTETLER HIT + RUN FOLLOW-UP
DATE: 3-18-99

DESTINATION FAX NUMBER:

NUMBER OF PAGES SENT (INCLUDING THIS COVER): 5

SPECIAL NOTES AND/OR COMMENTS:

FOLLOW-UP NEEDED IN CITY OF MANITOWOC
ON THIS ONE.

M. Mif

This message is intended only for the use of the individual or entity to which it is addressed and may contain information that is privileged, confidential, and exempt from disclosure under applicable law. If the reader of this message is not the intended recipient or the employee or agent responsible for delivering the message to the intended recipient, you are hereby notified that any dissemination, distribution, or copying of this communication is strictly prohibited. If you have received this communication in error, please notify us immediately by telephone and return the original message to us at the above address via the U.S. Postal Service. Thank you.

INCIDENT # 76884 SUPV. INT. CLASSIFICATION BEAT

TWO RIVERS POLICE INCIDENT CARD

INCIDENT TYPE Request From/To
INCIDENT # [redacted] E. River St
NAME (last, first, middle) MTSO (Business) D.O.B.
ADDRESS HOME TELEPHONE
CITY STATE ZIP WORK TELEPHONE

REC'D 030499 13:19
DISP 10-23 10-24
DAY THU
SUN MON TUE WED FRI SAT

OFFICERS ASSIGNED: Hall 853
REC. BY 920 DIS. BY
TYPE/REPORT ACCIDENT OFFICER NARRATIVE CASE
HOW RECEIVED ALM ALARM SCN AT THE SCENE CB CB RADIO DIG DISPATCH FAX FAX FOP FOUND/PATROL DSK FRONT DESK PER IN PERSON MAL MAIL OFF OFFICER/OFF DUTY OTH OTHER OTH OTHER AGENCY RAD RADIO TEL TELEPHONE/DEAF TEL TELEPHONE TTY TELETYPE 911 911 TELEPHONE
STATUS AC ACTIVE CA CLEARED/ARREST CB CLOSED CC COMMITMENT EMER DETEN DA DETENTION/ALCOHOL EC EX CLEAR IN INACTIVE OT OTHER UL UNABLE/LOC UN UNFOUNDED

NARRATIVE: Request we check vehicle at above address bearing WI 5JL436, 1983 Chev 853/checked on 3/4/99, vehicle not present

IF COMPLAINANT DIFFERENT THEN CALLER, ENTER NAME, ADDRESS, D.O.B., TELEPHONE

T.I.M.E. SYSTEM ENTRY

Table with columns: ENTERED, DATE, TIME, INITIALS, CANCELLED, DATE, TIME, INITIALS. Rows for CIB, NCIC, OTHER BROADCAST.

ALL SHADED AREAS TO BE COMPLETED BY TWO RIVERS POLICE DEPARTMENT EMPLOYEES

TWO RIVERS POLICE DEPARTMENT EMPLOYEES TO COMPLETE INFORMATION BELOW

INVESTIGATIVE PROCESSING INFORMATION:

- EVIDENCE COLLECTED [] PROPERTY COLLECTED [] PHOTOGRAPHS TAKEN [] VIDEOS TAKEN [] STATEMENTS COMPLETED []
NON-CONSENT FORM COMPLETED [] FINGERPRINTS LIFTED [] SUSPECT FINGERPRINTS TAKEN []

ASSIGNMENTS:

Table with columns: OFFICER, TASK, DATE ASSIGNED, DATE DUE. Row 1: Strong, Continue follow-up, 3/5/99, 3/6/99

INCIDENT # 76884

TWO RIVERS POLICE DEPARTMENT

Date: 3/18/99

Page: 1

Case Description:
Request From/To Outside Authorities

Case Number: 99-0000076884

Primary Victim: NONE

Date/Time Reported: 3/04/99 13:19 Hrs.

Dispatch Incident Type:

Date/Time Occurred: 3/04/99 13:19 Hrs.

ReqFrom/To

Date/Time Between : 3/04/99 13:19 Hrs.

Location Occurred : EAST RIVER ST

Cross Street . . . :

Area: BEAT 1 Section: 1024

Grid:

Reporting Officer : 853 NOLL,ROBERT,,

Primary Unit Assigned to Investigate:

Scene Processed by:

Assigned Investigators:

Case Status: Active-Ope Disposition:

Disp. Date: 0/00/00

No. of Offenses:

No. of Offenders:

No. of Victims:

SUBJECTS:

Informatnl : Present Information

Primary DOBBS,ROBERT,A,
EAST RIVER ST
TWO RIVERS

Phone: [REDACTED]

WI 54241

Race : White Sex: Male D.O.B: [REDACTED] Age: 31

Hgt : " Wgt: Hair: Eyes . . . :

Build: Complexion: Ethnicity:

Dr Lic #: St: Soc Sec #:

Residence Type : Residence Status :

Extent of Injury: Medical Treatment:

Injury Type . . . : Injury Type . . . :

Hospital/Clinic : Transported by . . . :

Statement Type : Related Offenses :

Suspect Vehicle:

Vehicle Year: 1983 Description: 83 CHEV TRUCK

Make . . . : CHEVROLET Model : Style . . : Truck

Color Top . . : Unknown Bottom: Unknown Interior: Unknown

License # . . : SJL436 State : WI Year: 0 Type: Passenger

Serial #/VIN: [REDACTED] OAN . . . :

Vehicle Type: Automobile Engine #:

Reported . . : 3/04/99 13:19 Hrs. Venue . . :

Area . . . : Section: Grid . . . :

Location . . . :

Cross Street:

narrative

Complainant request we check vehicle at above address. 853 checked on 03-04-99 vehicle not present Officer Strouf assigned to

03/18/1999 13:40

TWO RIVERS POLICE

PAGE 04

TWO RIVERS POLICE DEPARTMENT

Date: 3/18/99

Page: 2

Case Description:
Request From/To Outside Authorities

Case Number: 99-0000076884

checked by MTPD but not documented. Residence checked on 03-05-99
(1600,1800,2100 hours). 03-06-99 (1530, 1700, 2000 hours). 03-07-99
(1440, 1730 hours). Vehicle not at residence. Officer will continue
checking on 03-14-99.

Incident #99-76884

Officer _____

Supervisor _____

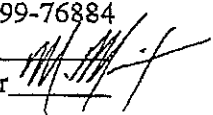

03/18/99

Mr. Robert Dobbs called the police department because an officer was attempting to contact him in regard to a Chevrolet Blazer he once owned. I (Lt. Mixa) spoke to Dobbs. He advised that the vehicle in question is a 1983 Chevrolet S-10 Blazer. He states that he purchased this vehicle from a Thomas Melichar back in 1997. He states that the vehicle did have bumper and grill damage when he bought it and didn't want to stick the money into it to fix it. He further states that Melichar lives at [REDACTED] River Heights Lane in Mishicot and that his phone number is [REDACTED].

Mr. Dobbs further stated that he sold this vehicle to a Todd Jaschob in February of this year (1999). He did not know Jaschob's address but he lives in Manitowoc and he states that Jaschob's phone number is [REDACTED]. Mr. Dobbs also stated that the vehicle still had bumper and grill damage when he sold it to Jaschob.

In searching the phone book I (Lt. Mixa) found a listing for a Samantha Jaschob of [REDACTED] Michigan Avenue in Manitowoc with the same number given by Mr. Dobbs, [REDACTED].

This vehicle has not been viewed yet in regard to the fatal hit & run in Manitowoc County. A copy of this report has been faxed to MTSO for their follow up, to the attention of Lt. Mike Bushman. A copy has also been forwarded to Captain Ammerman for his information.

3/18/99 1256 hours Mixa 822

1. CASE # S99 No 01811 2. CLASSIFICATION 6301 3. CENSUS 14011

MANITOWOC COUNTY SHERIFF INCIDENT CARD

4. INCIDENT CS/S99-00242

18. ASSIGNED Bushman 4141 929

5. INCIDENT LOCATION

6. NAME - LAST - FIRST - MI Anon 7. D.O.B

8. ADDRESS 9. TX-HOME

11. CITY STATE ZIP 10. TX-BUSINESS

12. DETAILS Caller states that [redacted] knows who

the driver of the hit & run is and they

already got rxd of the truck.

3-3-99 1400

19. REC. BY 926 20. DIS. BY

21. HOW REC'D. 1. 911 2. POLICE RADIO 3. PHONE 4. TTY 5. IN PERSON 6. ON VIEW 7. OFF. OFF DUTY 8. C.B. RADIO 9. OTHER

22. TYPE OF REPORT 1. INCIDENT 2. ACCIDENT 3. CITATION 4. NONE

23. STATUS 1. UNFOUNDED 2. PNL 3. OTHER 4. CLEARED 5. EXCEPT CLEARED

24. DATE CLEARED 13/10/99 25. OFFENSE TYPE 1. ADULT 2. JUVENILE 3. UNKNOWN

14. REC'D 15. DISP 16. 10-23 17. 10-24 13. DAY SUN 1 THU 5 MON 2 FRI 6 TUE 3 SAT 7 WED 4

39. (CODE S-SUSPECT W-WITNESS V-VICTIM O-OTHER)	40. NAME-LAST	FIRST	MI	41. D.O.B.	42. ADDRESS	43. TELEPHONE
0	[redacted]	[redacted]	[redacted]	[redacted]	[redacted]	[redacted]
0	[redacted]	[redacted]	[redacted]	[redacted]	[redacted]	[redacted]
0	Hanzel, Victoria L.			[redacted]	Nuclear Rd., Mishicot	[redacted]
0	Haese, Denise L.			[redacted]	Hilltop Rd. Reedsville	[redacted]

03/03/99 1500hrs Attempted contact with Complainant, message left.
 1815hrs No response from Complainant. Contact attempted with [redacted] he was not at home, young female answering phone stated he would not be home until late, however does have a cell phone number she could attempt contact and have him call me. M.J.Bushman
 1848hrs Contact attempted again this time talking to an older female, sounded like his mother. She stated she will talk with him and a good time to get ahold of him is 0900hrs 03/04/99, he will be home.
 03/04/99 0900hrs Contact made by phone with the residence and the same young female answered saying [redacted] was not home and she could not get ahold of him. She would not give out cell number, reluctantly agreed to try calling. I got the impression he was standing there.
 Complainant [redacted] did call back leaving message, Absolutely do not call him at work home after 9PM. M.J.Bushman
 03/04/99 1415hrs [redacted] had been ice fishing on Sturgeon Bay and now arrived home, offering to come to MISO for interview.
 [redacted] arrived on schedule and interview conducted in basement squad room. He advised he can't imagine who would have called about looking into his activities. He stated he had no personal knowledge of the accident other than what was on the news, however he did overhear a conversation from friends who know another who would have personal knowledge of suspect. [redacted] heard that [redacted] (late twenties from Mishicot) would know who the suspect is, and may have been threatened not to say anything about it or they would be killed. [redacted] gave up the name of the party telling him the information but does not wish for that name or his to be known by [redacted]
 1432hrs Contact made by phone with [redacted] She agreed to come to MISO after school 03/05/99 1230hrs for interview, only if it is not known later where the information came from. M.J.Bushman
 03/05/99 120hrs Interview with [redacted] completed in Conference Room D. She had information from Victoria Hanzel that a babysitter for her sister inlaw Denise Haese, knows who the driver of the suspect vehicle was and where the vehicle is right now. The babysitter's first name is [redacted] and she works on a farm.
 Contact by phone made with Haese and Hanzel, [redacted] is the person I need to talk with.
 Contact by phone made with [redacted] who was working at Soaring Eagle Dairy and she agreed to come in for interview 1730hrs. M.J.Bushman
 0 [redacted]

45. IF COMPLAINANT DIFFERENT THEN CALLER, ENTER NAME, ADDRESS, D.O.B., TELEPHONE.

46. IF CODE O (OTHER) IS USED IN FIELD #39, EXPLAIN.

INCIDENT REPORT: NOTE: IF SECTION 22 ABOVE HAS NUMBER 4 CHECKED, DO NOT GO BEYOND THIS LINE WITHOUT RECORDS SECTION BEING ADVISED, OR NO RECORD ENTRIES WILL BE MADE BELOW THIS LINE.

PROPERTY VALUE	26. PROPERTY	A. CURRENCY	B. JEWELRY	C. FURS CLOTHING	D. VEHICLE (LOCAL)	E. OFFICE EQUIPMENT	F. RADIO, TV CAMERAS	G. FIREARMS	H. HOUSE-HOLD GOODS
	STOLEN	\$	\$	\$	\$	\$	\$	\$	\$
	RECOVERED	\$	\$	\$	\$	\$	\$	\$	\$
	26. PROPERTY	I. CONSUM-ABLES	J. LIVESTOCK	K. DRUGS	L. MARINE ITEMS	M. CONSTRUCTION ITEMS	N. LAWN AND GARDEN	O. SPORTING GOODS	P. MISC BICYCLE
STOLEN	\$	\$	\$	\$	\$	\$	\$	\$	
RECOVERED	\$	\$	\$	\$	\$	\$	\$	\$	

27. PROPERTY RECOVERED: LOCALLY _____ OTHER JURISDICTION _____ (INSERT O OR L)

PROPERTY ITEMIZATION	PROPERTY STOLEN/RECOVERED ITEMIZATION, USE THE FOLLOWING FORMAT				
	28. QUANTITY	29. ARTICLE NAME	30. BRAND NAME	31. SERIAL NUMBER	32. CODE
					S R <input type="checkbox"/> <input type="checkbox"/>
					S R <input type="checkbox"/> <input type="checkbox"/>
					S R <input type="checkbox"/> <input type="checkbox"/>
					S R <input type="checkbox"/> <input type="checkbox"/>

33. PROPERTY DAMAGE AMOUNT \$ _____

34. INSURANCE COMPANY _____

35. OFFICER ASSAULTED Y N

36. ARSON Y N

37. STRUCTURE CODE _____

38. DAMAGE \$ _____

47. CIB
NCIC
OTHER BROADCAST

ENTERED CANCELLED

48. TOTAL AMOUNT PROPERTY STOLEN \$ _____

49. TOTAL AMOUNT PROPERTY RECOVERED \$ _____

50. IS REPORT CONTINUED? YES NO

51. CAUTION INDICATORS, ATLS ETC.

52. DATA PROCESS INFORMATION:

COMPUTER ENTERED DATE 3/16/99
MICROFILM INDEXED INITIAL AS

IS CASE CLASSIFICATION CORRECT? Y N
IF N HAS CORRECTION BEEN MADE? N

53. FILE APPROVAL

BY KR DATE 03/16/99

MANITOWOC COUNTY SHERIFF'S DEPARTMENT
FOLLOW-UP REPORT

Page: 2

CASE NUMBER: 599-01811 CLASSIFICATION: _____

INCIDENT: _____

DATE AND TIME: _____

REPORT CONTINUED:

JUVENILE INFO REDACTED

0 [REDACTED] [REDACTED] [REDACTED] [REDACTED] [REDACTED]

03/05/99 @ 1715 Hrs.: While waiting for [REDACTED] to arrive for an interview, I (Lt. M. Bushman) spoke with a young man who approached Deputy A. Bonfigt with information. He will remain anonymous. He also told me that [REDACTED] was with a group of young men when he stated he [REDACTED] "knows someone who knows the driver and where the truck is but will not come forward because their life was threatened." No other information or detail as to who that person might be was provided. The information was almost identical, word for word, for the description which started this complaint.

03/05/99 @ 1725 Hrs.: [REDACTED] arrived at MTSO and was interviewed in the Squad Room. I explained the reason she was here was because I obtained her name after back-tracking and talking with 7 other people. She kept saying she keeps to herself, has very few people who she considers friends, works, stays home, sees her boyfriend, and does her homework in a home school program, planning to graduate high school this year. She said she home schools because she does not get along with teachers well, admitting her mouth gets her into trouble. She stated she was, "Just like my mom and my grandmother. I speak my ^{peace} piece. Sometimes, I say too much."

When pressed, she insisted she knows nothing about the incident and only has heard rumors. We talked about the rumors. She said, "Like the one about the guy in Clover hiding his truck." She could not provide a name. When I mentioned a few names, she stated she just did not know. She then asked if her boyfriend, [REDACTED] or her mother gave me her name reference this complaint.

I pressured her a little harder, asking why should anyone give me her name if she did not know anything and did not pass any rumors. She became uneasy about passing rumors. She knew RICK HOCHSTETLER and even bowled with him on occasions. She recently had a talk with his mother, DEBRA WETENKAMP. [REDACTED] stated RICK'S mouth occasionally got him into trouble and some people did not like his "cocky" attitude. [REDACTED] stated she really wants to see the suspect caught and if she knew anything at all, she would tell me. She stated the same thing should be done to the suspect if he is caught that was done to RICK.

After pressing a little harder, [REDACTED] became uneasy, and the interview was completed after about 30 minutes. As I walked her up to the front Jail Lobby, I gave her my business card and requested, if she heard anything that would be helpful, she should give me a call. I apologized if I pushed her too hard, and she stated she understood.

She smiled and at one point stated she was concerned about her boyfriend, [REDACTED]. She stated [REDACTED] is obsessed with the idea that the individual in Clover is definitely the suspect and is hiding his vehicle. She stated [REDACTED] has done several things on his own to try and investigate and then stop short with the conversation. She would not elaborate on what types of the things he has done. I then informed [REDACTED] the suspect in Clover, I

MANITOWOC COUNTY SHERIFF'S DEPARTMENT
FOLLOW-UP REPORT

Page: 3

CASE NUMBER: 599-01811 CLASSIFICATION: _____

INCIDENT: _____

DATE AND TIME: _____

REPORT CONTINUED:

believe to be ROHL, was personally checked by me. The van which sits in his front yard had not been moved for at least an hour prior to the accident as officers checked that van with the damage shortly after arriving on the scene, and there were no fresh tracks in the snow which indicated it was moved. I also indicated he did have a pickup truck which matched the description; however, it was broken down and in his brother-in-law's garage at the time of the incident. With that information, [REDACTED] stated, "I'm glad you told me that. I wish [REDACTED] would've known that." She then seemed to be somewhat relaxed. [REDACTED] left MTSO.

After following this complaint from the rumor which was overheard and finding the source, I believe this is exactly what this complaint is--a rumor.

03/06/99 @ 1245 Hrs.: Attempted contact with [REDACTED] at [REDACTED] No one was home.

I, Lt. Bushman, believe this complaint started as a rumor. There is no fact as to any of the comments. Incident can be closed at this time. MJBushman /bjc

MJB

1. CASE # **S99 No 01643** 2. SUBSCRIPTION 6,3|0,1| 3. CITIES 7,0|0,0,0

4. INCIDENT **S99-00742**
 5. LOCATION

6. NAME-LAST-FIRST-MI **Anonymous** 7. D.O.B.

8. ADDRESS 9. TX-HOME

11. CITY STATE ZIP 10. TX-BUSINESS

12. DETAILS **See Attached.**

Full size Chev Van Registration AM18045

02/25/99 1659

14. REC'D	15. DISP	16. 10-23	17. 10-24
SUN 1	THU 5	MON 2	FRI 6
TUE 3	SAT 7	WED 4	

MANITOWOC COUNTY SHERIFF INCIDENT CARD

18. ASSIGNED MTSO **M. Bushman** 9 2 9
 19. REC. BY **935** 20. DIS. BY

22. TYPE OF REPORT
 1. INCIDENT
 2. ACCIDENT
 3. CITATION
 4. NONE

21. HOW REC'D.
 1. 911
 2. POLICE RADIO
 3. PHONE
 4. TTY
 5. IN PERSON
 6. ON VIEW
 7. OFF. OFF DUTY
 8. C.B. RADIO
 9. OTHER

23. STATUS
 1. UNFOUNDED
 2. PNL
 3. OTHER
 4. CLEARED
 5. EXCEPT CLEARED

24. DATE CLEARED **10/20/99**
 25. OFFENSE TYPE
 1. ADULT NA
 2. JUVENILE
 3. UNKNOWN

39. (CODE S-SUSPECT W-WITNESS V-VICTIM O-OTHER)	40. NAME-LAST	FIRST	MI	41. D.O.B.	42. ADDRESS	43. TELEPHONE
0	Arroyo Angel	198592			West Greenfield, Milwaukee	53204
	L. REWOLINSKI	SGT. MOORE	OFF. SWIERCZ		DISTRICT 2 MILWAUKEE PD.	

03/12/99
 Information received is [redacted] W.Greenfield should be District 2 Milwaukee Fax sent.M.J.B. Manitoowoc County SO is investigating a Fatal Hit & Run Accident from 01/10/99 0225hrs on CTH CR South of the City of Manitowoc. CTH CR is roadbed from the Old 141 highway and is currently a frontage road for I-43. Suspect vehicle struck a 17 year old young man walking South on the West shoulder. Victim was then dragged 300 Ft. down the roadway and left to die. Victim was 6'1 210 pounds.
 Suspect vehicle is a 1985-1987(some very early 1988) Chevrolet Pickup, Suburban, K-5 (full size)Blazer or 1989-1991 Chev van. Damage will be extensive to the grill some hood and possibly bumper. There were parts from the engine fan shroud at the scene indicating the radiator support wall was pushed backward turning the shroud into the fan. The radiator did not leak. Damage concentration would be just to the left of center (if facing vehicle front) between the Chevrolet emblem and passenger side headlamp. No glass or lense material found at scene. There may be windshield damage. Vehicle is a low line Chev product like a Custom Deluxe or Scotsdale version, single rectangular semi round headlamp at each side of grill. Vehicle should be standard height, no lift kit, tires 7 1/2 inch wide non aggressive thread, your basic Fleet Farm special.

Request your assistance in checking the above listed vehicle in your area, call MTSO and speak with Lt.Michael J.Bushman for further detail. [redacted] M.J.Bushman

03/20/99 Copy of report faxed to District 2 Milwaukee. M.J.Bushman
 03/21/99 2200hrs Phone contact made with Dispatcher Hencesik and request he use some of his Milwaukee influence with District 2. On two prior occasions a teletype was sent with no response.
 0439hrs Sgt. Johnson phoned Lt.Bushman stating a vehicle matching H&R suspect vehicle was located at the address given. They would not hold an officer on scene long and requested a call back for details.
 Contact by phone made to Lt.Rewolinski who had Off.Swiercz on scene-call forwarded. The vehicle was described as a K-5 Blazer with grill nearly all gone, damage to hood,bumper and radiator pushed in but not leaking, tan and black. Off. stated it looked like a soft hit not impact with another vehicle or pole. Pictures were taken and Officers sat on the vehicle until I could arrive. Contacts were attempted at near residences no answers as to who owned the vehicle. Vin and Texas 94 truck registration matched

CASE # S99 No 01643

45. IF COMPLAINANT DIFFERENT THEN CALLER, ENTER NAME, ADDRESS, D.O.B., TELEPHONE.

46. IF CODE O (OTHER) IS USED IN FIELD #39, EXPLAIN.

INCIDENT REPORT: NOTE: IF SECTION 22 ABOVE HAS NUMBER 4 CHECKED, DO NOT GO BEYOND THIS LINE WITHOUT RECORDS SECTION BEING ADVISED, OR NO RECORD ENTRIES WILL BE MADE BELOW THIS LINE.

PROPERTY VALUE	26. PROPERTY	A. CURRENCY	B. JEWELRY	C. FURS CLOTHING	D. VEHICLE (LOCAL)	E. OFFICE EQUIPMENT	F. RADIO, TV CAMERAS	G. FIREARMS	H. HOUSE-HOLD GOODS
	STOLEN	\$	\$	\$	\$	\$	\$	\$	\$
	RECOVERED	\$	\$	\$	\$	\$	\$	\$	\$
	26. PROPERTY	I. CONSUM-ABLES	J. LIVESTOCK	K. DRUGS	L. MARINE ITEMS	M. CONSTRUCTION ITEMS	N. LAWN AND GARDEN	O. SPORTING GOODS	P. MISC BICYCLE
	STOLEN	\$	\$	\$	\$	\$	\$	\$	\$
	RECOVERED	\$	\$	\$	\$	\$	\$	\$	\$

27. PROPERTY RECOVERED: LOCALLY _____ OTHER JURISDICTION _____ (INSERT O OR L)

PROPERTY ITEMIZATION	PROPERTY STOLEN/RECOVERED ITEMIZATION, USE THE FOLLOWING FORMAT.				
	28. QUANTITY	29. ARTICLE NAME	30. BRAND NAME	31. SERIAL NUMBER	32. CODE
					S R <input type="checkbox"/> <input type="checkbox"/>
					S R <input type="checkbox"/> <input type="checkbox"/>
					S R <input type="checkbox"/> <input type="checkbox"/>
					S R <input type="checkbox"/> <input type="checkbox"/>

33. PROPERTY DAMAGE AMOUNT \$ _____

34. INSURANCE COMPANY _____

35. OFFICER ASSAULTED Y N

36. ARSON Y N

37. STRUCTURE CODE _____

38. DAMAGE \$ _____

47. CIB ENTERED CANCELLED
 NCIC
 OTHER BROADCAST

48. TOTAL AMOUNT PROPERTY STOLEN \$ _____

49. TOTAL AMOUNT PROPERTY RECOVERED \$ _____

50. IS REPORT CONTINUED? YES NO

51. CAUTION INDICATORS, ATLS ETC.

52. DATA PROCESS INFORMATION:

COMPUTER ENTERED DATE 4/22/99

MICROFILM INDEXED INITIAL AS

IS CASE CLASSIFICATION CORRECT? Y N
 IF N HAS CORRECTION BEEN MADE? Y N

53. FILE APPROVAL

BY [Signature] DATE 4/20/99

MANITOWOC COUNTY SHERIFF'S DEPARTMENT
FOLLOW-UP REPORT

Page: 2

CASE NUMBER: 599-011043 CLASSIFICATION: _____

INCIDENT: _____

DATE AND TIME: _____

REPORT CONTINUED:

03/22/99 @ 0745 Hrs.: Contact was made with Lt. Rowolinski at District 2 HQ in Milwaukee. He had several Polaroid pictures of the Blazer officers were watching. The vehicle turned out to be an S10 Chevrolet Blazer, not a K5, full-sized Blazer. Officer Swiercz did not have a description sheet with him that I had faxed down. He saw the S10 with the similar damage and mis-stated in our conversation that it was a K5.

Five \$25,000 reward posters were provided for each of the districts in Milwaukee, and a photocopy of the front description is attached. The RP of AM18045 on a 1985 Chevy van is the vehicle description generating this Crime Stopper complaint. It will be given out to roll call at District 2 for the next few days to concentrate on looking for the van which is described on the front. Officer Swiercz, Lt. Rowolinski, and Sgt. Moore were all talked to personally and will attempt follow-up with contacts at [redacted] W Greenfield to see if the vehicles and owner(s) can be located. All the 10-28s and teletypes sent reference today's follow-up is attached to this complaint. MJBushman /bjc

04/16/99 Vehicle not located, Close Out. M.J. Bushman

3/01/99 Part 1
By User: SCHEVERS DM

INCIDENT DETAIL PRINT
OUTAGAMIE COUNTY SHERIFFS DEPARTMENT

99-0023-309 Page 1

SERVICE INFORMATION

Sequence#: 1

How Receive: 02 Telephone District: LC1 Date: 2/26/99 Day: 6 Time: 21:00
Nature.....: AGENCY ASSIST Rcvd by:438 Dispatch by: 438 Shift
Location...: [REDACTED] W MAIN STREET Apt:
City/State.: LITTLE CHUTE WI 54140

Vehicle Lic: PLM442 Vehicle ID #: [REDACTED] State: WI Exp: 99

Reported by: MANITOWOC COUNTY SHERIFFS DEPT
Location...: [REDACTED] S NINTH STREET Apt:
City/State.: MANITOWOC WI 54220 Sex:

Report Code: 1 Arrests: Disposition: 004 Ref oth agency
ISC.....:9902 Incd Cd: 1 Police Incident CURRENT STATUS INFORMATION
UCR.....: 00 ASSIST OTHER AGENCY INVEST/ETC Unit: 231 Disp Ref oth agency
Mult Calls: as of 2/26/99

Note.....: CHECK FOR HIT AND RUN VEHICLE

ASSIGNED UNITS

Unit	Name	Jur	Type	Filed	Resp	T	Disp	Arrv	Clrd	Total
1	SPAETH, DAVID	44	P	F	4		21:00	21:21	21:43	22
614	SEEMAN, MICHAEL (LCP)	56	P		4		21:21	21:21	21:38	17

Offense Rpt#: 1 CONTACT INFORMATION

----- CONTACT INFORMATION -----
Document: 1 Filed by: 231 Date: 2/26/99

Contact.....: MANITOWOC COUNTY SHERIFFS DEPT D.O.B.: 0/00/00
Address.....: █████ S NINTH STREET
City/state...: MANITOWOC WI 54220
Sex.....: Race: Phone: █████

Contact.....: Report. Person Desc.....: AGENCY ASSIST
Contact Date: 2/26/99 Report No...: 990023309
Report Type.: Offense Report Disp Date..: 2/26/99
Disposition.: Referred to other agency Injury.....:
Actions.....: Victim type:
Circumstance:

----- CONTACT INFORMATION -----
Document: 2 Filed by: 231 Date: 2/26/99

Contact.....: KONETZKE, GARY L. D.O.B.: █████
Address.....: █████ E WISCONSIN AVENUE
City/state...: APPLETON WI 54915 0000
Sex.....: Male Race: White Phone: █████

Contact.....: Citizen Contact Desc.....: AGENCY ASSIST
Contact Date: 2/26/99 Report No...: 990023309
Report Type.: Offense Report Disp Date..: 2/26/99
Disposition.: Referred to other agency Injury.....:
Actions.....: Victim type:
Circumstance:

3/01/99 Part 8
By User: SCHEVERS DM

INCIDENT DETAIL PRINT
OUTAGAMIE COUNTY SHERIFFS DEPARTMENT

99-0023-309 Page 4

Doc #: 1 Type: S Filed by: 231 Date: 2/26/99 COMPLETE

Manitowoc SO requested a possible suspect van from a fatality hit and run accident be checked. Spaeth #231/ds

Sgt. Spaeth #231 reporting:

On 02-26-99, reporting officer spoke with Lt. Bushman from the Manitowoc County Sheriff's Dept. He explained that his department was investigating a fatality hit and run accident which had occurred on 01-10-99. He explained that he had received information that a possible suspect vehicle was at the Hawk Nest Tavern, [REDACTED] W. Main St., Little Chute. The suspect vehicle was a 1987 Chevrolet van, blue and gray primer colored, plate no. PCM442. The owner of the van was GARY L. KONETZKE, DOB [REDACTED], [REDACTED] E. Wisconsin Av e., Appleton, ph. [REDACTED]. Mr. Konetzke is the owner of the Hawk Nest Tavern and Lt. Bushman indicated that he had spoken with him over the phone earlier in the evening. Lt. Bushman indicated that Mr. Konetzke had indicated that he had front end damage to his van, but that the damage had occurred two years ago when he had collided with a tree. Lt. Bushman requested that the van be inspected.

Reporting officer and Officer Mike Seaman of the Fox Valley Metro PD responded to the Hawk Nest Tavern, arriving at approximately 9:25PM. The suspect vehicle was located in the parking lot. The vehicle did have minor damage to the front bumper and hood area and the front grill was missing. Reporting officer took three Polaroid photographs of the damaged area. Reporting officer also spoke with Mr. Konetzke about the damage to his van. He stated that the damage had occurred a couple of years ago while he was up north and that there was no report of the accident which had caused the damage because he never reported the incident.

A copy of this report along with the above mentioned photos will be forwarded to Lt. Bushman of the Manitowoc County Sheriff's Dept.

Spaeth #231/ds

1. CASE # S99 No 01662 2. CLASSIFICATION 6301 3. CENSUS 091106

4. INCIDENT CS 1599-0242

5. INCIDENT LOCATION SB ON Q

7. D.O.B. 3608

8. ADDRESS [REDACTED] 9. TX-HOME [REDACTED]

11. CITY [REDACTED] STATE [REDACTED] ZIP [REDACTED] 10. TX-BUSINESS [REDACTED]

12. DETAILS REPORTS BLU/WHI CHEV BLAZER

RUSTY w/ 1 m-occupant. POSSIBLE

PLATE OF SLV-436. GRILL IS OUT

6229
0829
0835
022699
14. REC'D
15. DISP
16. 10-23
17. 10-24
13. DAY
SUN 1 THU 5
MON 2 FRI 6
TUE 3 SAT 7
WED 4

MANITOWOC COUNTY SHERIFF
INCIDENT CARD

18. ASSIGNED
Glaeser
Bushman
MITSO
4117
4111
9009

19. REC. BY 923 20. DIS. BY 923

22. TYPE OF REPORT
1. INCIDENT
2. ACCIDENT
3. CITATION
4. NONE

21. HOW REC'D.
1. 911
2. POLICE RADIO
3. PHONE
4. TTY
5. IN PERSON
6. ON VIEW
7. OFF. OFF DUTY
8. C.B. RADIO
9. OTHER

23. STATUS
1. UNFOUNDED
2. PNL
3. OTHER
4. CLEARED
5. EXCEPT CLEARED

24. DATE CLEARED 020899

25. OFFENSE TYPE
1. ADULT NA
2. JUVENILE
3. UNKNOWN

21A. M.O.

39. (CODE S-SUSPECT W-WITNESS V-VICTIM O-OTHER)

CODE	40. NAME-LAST	FIRST	MI	41. D.O.B.	42. ADDRESS	43. TELEPHONE

03/02/99 Vehicle comes back to suspect farther away and a different style. Contact made by with complainant for a better description. He advised he only saw the vehicle once as it was moving through area of CTB B and STH 310. Unsure of plate, vehicle was a rusted out Chev. S-10 model blazer, blu and white. This description does not match the suspect vehicle This complaint can be closed out. M.J.Bushman

45. IF COMPLAINANT DIFFERENT THEN CALLER, ENTER NAME, ADDRESS, D.O.B., TELEPHONE.

46. IF CODE O (OTHER) IS USED IN FIELD #39, EXPLAIN.

INCIDENT REPORT: NOTE: IF SECTION 22 ABOVE HAS NUMBER 4 CHECKED, DO NOT GO BEYOND THIS LINE WITHOUT RECORDS SECTION BEING ADVISED, OR NO RECORD ENTRIES WILL BE MADE BELOW THIS LINE.

PROPERTY VALUE	26. PROPERTY	A. CURRENCY	B. JEWELRY	C. FURS CLOTHING	D. VEHICLE (LOCAL)	E. OFFICE EQUIPMENT	F. RADIO, TV CAMERAS	G. FIREARMS	H. HOUSE-HOLD GOODS
	STOLEN	\$	\$	\$	\$	\$	\$	\$	\$
	RECOVERED	\$	\$	\$	\$	\$	\$	\$	\$
	26. PROPERTY	I. CONSUMABLES	J. LIVESTOCK	K. DRUGS	L. MARINE ITEMS	M. CONSTRUCTION ITEMS	N. LAWN AND GARDEN	O. SPORTING GOODS	P. MISC BICYCLE
	STOLEN	\$	\$	\$	\$	\$	\$	\$	\$
	RECOVERED	\$	\$	\$	\$	\$	\$	\$	\$

27. PROPERTY RECOVERED: LOCALLY _____ OTHER JURISDICTION _____ (INSERT O OR L)

PROPERTY ITEMIZATION	PROPERTY STOLEN/RECOVERED ITEMIZATION, USE THE FOLLOWING FORMAT				
	28. QUANTITY	29. ARTICLE NAME	30. BRAND NAME	31. SERIAL NUMBER	32. CODE
					S R <input type="checkbox"/> <input type="checkbox"/>
					S R <input type="checkbox"/> <input type="checkbox"/>
					S R <input type="checkbox"/> <input type="checkbox"/>
					S R <input type="checkbox"/> <input type="checkbox"/>

33. PROPERTY DAMAGE AMOUNT \$ _____

34. INSURANCE COMPANY _____

35. OFFICER ASSAULTED Y N

36. ARSON Y N

37. STRUCTURE CODE _____

38. DAMAGE \$ _____

47. CIB ENTERED CANCELLED
 NCIC
 OTHER BROADCAST

48. TOTAL AMOUNT PROPERTY STOLEN \$ _____

49. TOTAL AMOUNT PROPERTY RECOVERED \$ _____

50. IS REPORT CONTINUED? YES NO

51. CAUTION INDICATORS, ATLS ETC.

52. DATA PROCESS INFORMATION:

COMPUTER ENTERED DATE 3.8.99

MICROFILM INDEXED INITIAL AS

IS CASE CLASSIFICATION CORRECT? Y N
 IF N HAS CORRECTION BEEN MADE? Y N

53. FILE APPROVAL

BY [Signature]

DATE 3.8.99

1. CASE # 99 No 01663 2. CLASSIFICATION 63011 3. CENSUS 52000

4. INCIDENT 5 / 599-00242

5. INCIDENT LOCATION Remer's pk lot [redacted] 5.10th [redacted] jcing wish st.

6. NAME - LAST - FIRST - MI Group. 7. D.O.B.

8. ADDRESS 9. TX-HOME

11. CITY STATE ZIP 10. TX-BUSINESS

12. DETAILS
 White GMC, late 80's, Van
 w/blw reg. plate # XB 6041,
 and "Dean Morris Electric"
 on its side, is pk'd as of
 3 mths ago, and has quite a
 bit of damage.

14. REC'D 15. DISP 16. 10-23 17. 10-24
 13. DAY
 SUN 1 THU 5
 MON 2 FRI 6
 TUE 3 SAT 7
 WED 4

MANITOWOC COUNTY SHERIFF
 INCIDENT CARD

18. ASSIGNED
 MTSO 929
 Glaeser 417
 Bushman WHH

19. REC. BY 920 20. DIS. BY
 21. HOW REC'D.
 1. 911
 2. POLICE RADIO
 3. PHONE
 4. CITY
 5. IN PERSON
 6. ON VIEW
 7. OFF. OFF DUTY
 8. C.B. RADIO
 9. OTHER
 21A. M.O.

22. TYPE OF REPORT
 1. INCIDENT
 2. ACCIDENT
 3. CITATION
 4. NONE
 23. STATUS
 1. UNFOUNDED
 2. PNL
 3. OTHER
 4. CLEARED
 5. EXCEPT CLEARED
 24. DATE CLEARED 03/08/99
 25. OFFENSE TYPE
 1. ADULT NA
 2. JUVENILE
 3. UNKNOWN

39. (CODE S-SUSPECT W-WITNESS V-VICTIM O-OTHER)						
CODE	40. NAME-LAST	FIRST	MI	41. D.O.B.	42. ADDRESS	43. TELEPHONE
O	Morris, Dean M.	12815		[redacted]	[redacted] S31, Mtwc	[redacted]
O	Morris Dean Electric Inc.	90786				[redacted]

03/02/99 Vehicle listed above was involved in an accident in the City of Manitowoc 02/25/99 an accident report is on file. Close Out, M.J. Bushman

45. IF COMPLAINANT DIFFERENT THEN CALLER, ENTER NAME, ADDRESS, D.O.B., TELEPHONE.

46. IF CODE O (OTHER) IS USED IN FIELD #39, EXPLAIN.

INCIDENT REPORT: NOTE: IF SECTION 22 ABOVE HAS NUMBER 4 CHECKED, DO NOT GO BEYOND THIS LINE WITHOUT RECORDS SECTION BEING ADVISED, OR NO RECORD ENTRIES WILL BE MADE BELOW THIS LINE.

PROPERTY VALUE	26. PROPERTY	A. CURRENCY	B. JEWELRY	C. FURS CLOTHING	D. VEHICLE (LOCAL)	E. OFFICE EQUIPMENT	F. RADIO/ TV CAMERAS	G. FIREARMS	H. HOUSE-HOLD GOODS
	STOLEN	\$	\$	\$	\$	\$	\$	\$	\$
	RECOVERED	\$	\$	\$	\$	\$	\$	\$	\$
	26. PROPERTY	I. CONSUMABLES	J. LIVESTOCK	K. DRUGS	L. MARINE ITEMS	M. CONSTRUCTION ITEMS	N. LAWN AND GARDEN	O. SPORTING GOODS	P. MISC BICYCLE
STOLEN	\$	\$	\$	\$	\$	\$	\$	\$	
RECOVERED	\$	\$	\$	\$	\$	\$	\$	\$	

27. PROPERTY RECOVERED: LOCALLY _____ OTHER JURISDICTION _____ (INSERT O OR L)

PROPERTY ITEMIZATION	PROPERTY STOLEN/RECOVERED ITEMIZATION, USE THE FOLLOWING FORMAT			
	28. QUANTITY	29. ARTICLE NAME	30. BRAND NAME	31. SERIAL NUMBER
				S R <input type="checkbox"/> <input type="checkbox"/>
				S R <input type="checkbox"/> <input type="checkbox"/>
				S R <input type="checkbox"/> <input type="checkbox"/>
				S R <input type="checkbox"/> <input type="checkbox"/>
				S R <input type="checkbox"/> <input type="checkbox"/>
				S R <input type="checkbox"/> <input type="checkbox"/>

33. PROPERTY DAMAGE AMOUNT \$ _____ 34. INSURANCE COMPANY _____

35. OFFICER ASSAULTED Y N 36. ARSON Y N 37. STRUCTURE CODE _____ 38. DAMAGE \$ _____

47. CIB	ENTERED <input type="checkbox"/>	CANCELLED <input type="checkbox"/>	48. TOTAL AMOUNT PROPERTY STOLEN \$ _____
NCIC	<input type="checkbox"/>	<input type="checkbox"/>	
OTHER BROADCAST	<input type="checkbox"/>	<input type="checkbox"/>	
			49. TOTAL AMOUNT PROPERTY RECOVERED \$ _____

50. IS REPORT CONTINUED? YES NO 51. CAUTION INDICATORS, ATLS ETC.

52. DATA PROCESS INFORMATION:

COMPUTER ENTERED DATE 3/8/99

MICROFILM INDEXED INITIAL AS

IS CASE CLASSIFICATION CORRECT? Y N
IF N HAS CORRECTION BEEN MADE? Y N

53. FILE APPROVAL
BY [Signature] DATE 03/08/99

1. CASE # S99 No 01709
 2. CLASSIFICATION 6301
 3. CENSUS 14011

4. INCIDENT CS/S99-00242

5. INCIDENT LOCATION Dairy Queen Drive Thru in Brillion

6. NAME- LAST-FIRST-MI Anon 7. D.O.B.

8. ADDRESS 9. TX-HOME

11. CITY STATE ZIP 10. TX-BUSINESS

12. DETAILS
 Caller states a blazer with the front grill
 out just drove through the drive thru at
 the Dairy Queen in Brillion RP# LXC831
 Headed EB on Hwy 10

14:10 2-27-99

14. REC'D	15. DISP	16. 10-23	17. 10-24
13. DAY			
SUN 1	THU 5		
MON 2	FRI 6		
TUE 3	SAT 7		
WED 4			

MANITOWOC COUNTY SHERIFF INCIDENT CARD

18. ASSIGNED
 Bushman 929
 HHH

19. REC. BY 926	20. DIS. BY	22. TYPE OF REPORT 1. INCIDENT 2. ACCIDENT 3. CITATION 4. NONE
21. HOW REC'D. 1. 911 2. POLICE RADIO 3. PHONE 4. TTY 5. IN PERSON 6. ON VIEW 7. OFF. OFF DUTY 8. C.B. RADIO 9. OTHER		23. STATUS 1. UNFOUNDED 2. PNL 3. OTHER 4. CLEARED 5. EXCEPT CLEARED
24. DATE CLEARED 03 08 99		25. OFFENSE TYPE 1. ADULT <input type="checkbox"/> NA <input checked="" type="checkbox"/> 2. JUVENILE <input type="checkbox"/> 3. UNKNOWN <input type="checkbox"/>
21A. M.O.		

39. (CODE S-SUSPECT W-WITNESS V-VICTIM O-OTHER)					
CODE	40. NAME-LAST	FIRST MI	41. D.O.B.	42. ADDRESS	43. TELEPHONE

03/02/99 Vehicle involved is a 1991 Chev Blazer lists to above subject. Contact made by phone, Harder's vehicle does have grille damage from a truck vs pheasant, it is the newer model rounded front, no match. Close out. M.J. Bushman

45. IF COMPLAINANT DIFFERENT THEN CALLER, ENTER NAME, ADDRESS, D.O.B., TELEPHONE.

46. IF CODE O (OTHER) IS USED IN FIELD #39, EXPLAIN.

INCIDENT REPORT: NOTE: IF SECTION 22 ABOVE HAS NUMBER 4 CHECKED, DO NOT GO BEYOND THIS LINE WITHOUT RECORDS SECTION BEING ADVISED, OR NO RECORD ENTRIES WILL BE MADE BELOW THIS LINE.

PROPERTY VALUE	26. PROPERTY	A. CURRENCY	B. JEWELRY	C. FURS CLOTHING	D. VEHICLE (LOCAL)	E. OFFICE EQUIPMENT	F. RADIO, TV CAMERAS	G. FIREARMS	H. HOUSE-HOLD GOODS
	STOLEN	\$	\$	\$	\$	\$	\$	\$	\$
	RECOVERED	\$	\$	\$	\$	\$	\$	\$	\$
	26. PROPERTY	I. CONSUMABLES	J. LIVESTOCK	K. DRUGS	L. MARINE ITEMS	M. CONSTRUCTION ITEMS	N. LAWN AND GARDEN	O. SPORTING GOODS	P. MISC BICYCLE
STOLEN	\$	\$	\$	\$	\$	\$	\$	\$	
RECOVERED	\$	\$	\$	\$	\$	\$	\$	\$	

27. PROPERTY RECOVERED: LOCALLY _____ OTHER JURISDICTION _____ (INSERT O OR L)

PROPERTY ITEMIZATION	PROPERTY STOLEN/RECOVERED ITEMIZATION, USE THE FOLLOWING FORMAT				
	28. QUANTITY	29. ARTICLE NAME	30. BRAND NAME	31. SERIAL NUMBER	32. CODE
					S R <input type="checkbox"/> <input type="checkbox"/>
					S R <input type="checkbox"/> <input type="checkbox"/>
					S R <input type="checkbox"/> <input type="checkbox"/>
					S R <input type="checkbox"/> <input type="checkbox"/>
					S R <input type="checkbox"/> <input type="checkbox"/>

33. PROPERTY DAMAGE AMOUNT \$ _____ 34. INSURANCE COMPANY _____

35. OFFICER ASSAULTED Y N 36. ARSON Y N 37. STRUCTURE CODE _____ 38. DAMAGE \$ _____

47. CIB	ENTERED <input type="checkbox"/>	CANCELLED <input type="checkbox"/>	48. TOTAL AMOUNT PROPERTY STOLEN \$ _____
NCIC	<input type="checkbox"/>	<input type="checkbox"/>	
OTHER BROADCAST	<input type="checkbox"/>	<input type="checkbox"/>	
			49. TOTAL AMOUNT PROPERTY RECOVERED \$ _____

50. IS REPORT CONTINUED? YES NO

51. CAUTION INDICATORS, ATLS ETC.

52. DATA PROCESS INFORMATION:

COMPUTER ENTERED DATE 3.8.99
 MICROFILM INDEXED INITIAL LS
 IS CASE CLASSIFICATION CORRECT? Y N
 IF N HAS CORRECTION BEEN MADE? Y N

53. FILE APPROVAL

BY [Signature] DATE 3.8.99

1. CASE # S99 No 09701 2. CLASSIFICATION 630.11 3. CENSUS 117002

4. INCIDENT CS 599-00242

6. NAME - LAST - FIRST - MI Anonyms 7. D.O.B

8. ADDRESS 9. TX-HOME

11. CITY STATE ZIP 10. TX-BUSINESS

12. DETAILS See attached

31199 0930

MANITOWOC COUNTY SHERIFF
INCIDENT CARD

18. ASSIGNED
Glaeser (11)
Raube 410
Cort 1149

19. REC. BY 921 20. DIS. BY

21. HOW REC'D.
1. 911
2. POLICE RADIO
3. PHONE
4. TTY
5. IN PERSON
6. ON VIEW
7. OFF. OFF DUTY
8. C.B. RADIO
9. OTHER

22. TYPE OF REPORT
1. INCIDENT
2. ACCIDENT
3. CITATION
4. NONE

23. STATUS
1. UNFOUNDED
2. PNL
3. OTHER
4. CLEARED
5. EXCEPT CLEARED

24. DATE CLEARED 03/17/99

25. OFFENSE TYPE
1. ADULT NA
2. JUVENILE
3. UNKNOWN

39. (CODE S-SUSPECT W-WITNESS V-VICTIM O-OTHER)	40. NAME - LAST	FIRST	MI	41. D.O.B.	42. ADDRESS	43. TELEPHONE
O	[REDACTED]			[REDACTED]	[REDACTED]	[REDACTED]
W	[REDACTED]	[REDACTED]	[REDACTED]	[REDACTED]	[REDACTED]	[REDACTED]
O	ROSINSKY	DONALD			S 30th St. Manitowoc	[REDACTED]
S	MROZINSKI	DONALD	A		N CTH S, Cato	[REDACTED]

03/01/99 1010 Hrs I Deputy Glaeser spoke to [REDACTED] at his residence in Manitowoc. [REDACTED] said his Ex-wife told him early this morning that she thinks she knows who is responsible for the hit and run. [REDACTED] said his X-wife [REDACTED] used to tend bar at either Uncle Thirstys or Tom and Jerrys and had a patron who came in the bar early the day after the accident in January and acted real suspicious. [REDACTED] couldnt give me any specific information the suspect but said his X wife was talking about contacting the police about this party but she was afraid to make contact as she is a former drug user and excessive drinker. [REDACTED] said that [REDACTED] was probably up at Holy Family Hospital right at this moment where she could be contacted. [REDACTED] said [REDACTED] participates in therapy on a daily basis and is at the hospital till about 3PM every day. [REDACTED] did state that [REDACTED] could give officers all the info they would need if we talked to her.

03/01/99 at 1045Hrs I Deputy Glaeser made contact at Chemical Dependency wing at Holy Family Hospital and spoke to one of the nurses in charge of the floor. The nurse was familiar with [REDACTED] but stated she was presently in group therapy and preferred that I not bother her. I did leave a message with the nurse requesting [REDACTED] call our department when she was available.

03/01/99 @ 1140 Hrs I Deputy Glaeser did receive a phone call from [REDACTED] and she said she'd like to pass on some information to an officer but wouldnt be available to talk till after 1430 Hrs of todays date. This info was relayed to Lt Thorington and Deputy Raube was assigned to make contact with [REDACTED] when she arrived this afternoon.

EJG *[Signature]*

03/01/99 @ 1436 Hrs.: I, Deputy Raube, met with [REDACTED] at MTSO reference this incident. [REDACTED] indicated she had some possible information on the hit and run accident which she wished to report.

[REDACTED] stated she is a bartender at TJ'S TAVERN in Manitowoc. The Saturday after the accident occurred, an individual by the name of DON ROSINSKY (known to her as DON JUAN) came into the bar. [REDACTED] stated ROSINSKY is a heavy drinker and is in the bar quite often. [REDACTED] overheard a conversation among the patrons who were talking about the accident which occurred on CTH CR. [REDACTED] stated ROSINSKY got, in her words, "flushed" and told [REDACTED] that he was on CTH CR approximately 1/2 hour prior to the accident because he was heading to his parents' place. [REDACTED] stated she did not think much about this until later when she heard from her sister that ROSINSKY was in TJ'S again. ROSINSKY apparently

S99 No 0174

45. IF COMPLAINANT DIFFERENT THEN CALLER, ENTER NAME, ADDRESS, D.O.B., TELEPHONE.

46. IF CODE O (OTHER) IS USED IN FIELD #39, EXPLAIN.

INCIDENT REPORT: NOTE: IF SECTION 22 ABOVE HAS NUMBER 4 CHECKED, DO NOT GO BEYOND THIS LINE WITHOUT RECORDS SECTION BEING ADVISED, OR NO RECORD ENTRIES WILL BE MADE BELOW THIS LINE.

PROPERTY VALUE	26. PROPERTY	A. CURRENCY	B. JEWELRY	C. FURS CLOTHING	D. VEHICLE (LOCAL)	E. OFFICE EQUIPMENT	F. RADIO, TV CAMERAS	G. FIREARMS	H. HOUSE-HOLD GOODS
	STOLEN	\$	\$	\$	\$	\$	\$	\$	\$
	RECOVERED	\$	\$	\$	\$	\$	\$	\$	\$
	26. PROPERTY	I. CONSUMABLES	J. LIVESTOCK	K. DRUGS	L. MARINE ITEMS	M. CONSTRUCTION ITEMS	N. LAWN AND GARDEN	O. SPORTING GOODS	P. MISC BICYCLE
	STOLEN	\$	\$	\$	\$	\$	\$	\$	\$
	RECOVERED	\$	\$	\$	\$	\$	\$	\$	\$

27. PROPERTY RECOVERED: LOCALLY _____ OTHER JURISDICTION _____ (INSERT O OR L)

PROPERTY ITEMIZATION	PROPERTY STOLEN/RECOVERED ITEMIZATION, USE THE FOLLOWING FORMAT				32. CODE	
	28. QUANTITY	29. ARTICLE NAME	30. BRAND NAME	31. SERIAL NUMBER		
						S <input type="checkbox"/> R <input type="checkbox"/>
						S <input type="checkbox"/> R <input type="checkbox"/>
						S <input type="checkbox"/> R <input type="checkbox"/>
						S <input type="checkbox"/> R <input type="checkbox"/>

33. PROPERTY DAMAGE AMOUNT \$ _____

34. INSURANCE COMPANY _____

35. OFFICER ASSAULTED Y N

36. ARSON Y N

37. STRUCTURE CODE _____

38. DAMAGE \$ _____

47. CIB	ENTERED <input type="checkbox"/>	CANCELLED <input type="checkbox"/>
NCIC	<input type="checkbox"/>	<input type="checkbox"/>
OTHER BROADCAST	<input type="checkbox"/>	<input type="checkbox"/>

48. TOTAL AMOUNT PROPERTY STOLEN \$ _____

49. TOTAL AMOUNT PROPERTY RECOVERED \$ _____

50. IS REPORT CONTINUED? YES NO

51. CAUTION INDICATORS, ATLS ETC.

52. DATA PROCESS INFORMATION:

COMPUTER ENTERED DATE _____
 MICROFILM INDEXED INITIAL _____

53. FILE APPROVAL

IS CASE CLASSIFICATION CORRECT? Y N
 IF N HAS CORRECTION BEEN MADE? Y N

BY [Signature] DATE 03/17/99

MANITOWOC COUNTY SHERIFF'S DEPARTMENT
FOLLOW-UP REPORT

Page: 2

CASE NUMBER: 599-01741 CLASSIFICATION: _____

INCIDENT: _____

DATE AND TIME: _____

REPORT CONTINUED:

parents' place as he had told her. [REDACTED] stated she felt this was suspicious.

[REDACTED] stated she was again at TJ'S bartending when ROSINSKY came into the bar. [REDACTED] was not sure of the day, but she thought it was several days after the accident. ROSINSKY stated the police were at his residence and were investigating his vehicle. [REDACTED] stated ROSINSKY was extremely nervous. [REDACTED] stated she noticed ROSINSKY was not driving his red and silver S10 Blazer any more. ROSINSKY, instead, was driving a small, red car. [REDACTED] talked to ROSINSKY about this. He stated, a couple weeks prior to the accident on CTH CR, he hit something at ASSOCIATED BANK in Manitowoc and that is why he was not driving the vehicle any more. [REDACTED] did not have any more information.

I, Deputy Raube, did an alpha check on ROSINSKY. The only vehicle coming back to him is a 1983 Ford Escort station wagon, RP of CFH365.

Also, [REDACTED] indicated his vehicle had been checked prior by police, but I could not find anything in the computer matching that name. There was another ROSINSKY listed, but it did not have the first name of DON or DONALD. I discussed this information with Deputy Glaeser and advised him I would return this information to him and he could attempt to follow-up with ROSINSKY reference this incident to double-check. CRAube /bjc

03/08/99: Made a copy of this report for Deputy Glaeser per Deputy Raube. BJChristianson¹⁰

03/10/99 @ 0700 Hrs.: I, Deputy E. Glaeser, attempted to call DONALD ROSINSKY using the information which was received by Deputy Raube. At the time I placed the call, I was enroute to the address listed of [REDACTED] S 30th St, Manitowoc. A female party answered the phone at [REDACTED]. She told me there was no such party by the name of ROSINSKY at the residence. She also told me they never heard of any DONALD ROSINSKY. The female told me the last name of the family at this residence is STANGEL.

A short time later, I was able to drive by the address of [REDACTED] S 30th St, Manitowoc. I ran a 10-28 on a vehicle which was parked in the driveway at this residence. The 10-28 did indicate the vehicle was a 1985 Plymouth Horizon owned by MARDELL STANGEL.

03/10/99 @ 0730 Hrs.: I checked the telephone listings for DONALD ROSINSKY. I was able to locate a listing for one on N 7th St, Manitowoc.

03/10/99 @ 0740 Hrs.: I called the telephone number and got no answer. At this point, I had MTSO Dispatch check in-house for DONALD ROSINSKY for any information we might have available. Within a short time, they responded that only one was listed in our in-house computer and it did indicate this party was born in 1926 which would make him 73 years old this year.

03/10/99 @ 0745 Hrs.: I ran a 10-28 from the alpha check which was run by Deputy Raube on RP CFH365. This RP came back to DONALD ROSINSKY at the same address of [REDACTED] N 7th St, Manitowoc.

MANITOWOC COUNTY SHERIFF'S DEPARTMENT
FOLLOW-UP REPORT

Page: 3

CASE NUMBER: 599-01741 CLASSIFICATION: _____

INCIDENT: _____

DATE AND TIME: _____

REPORT CONTINUED:

03/10/99 @ 0800 Hrs.: I, Deputy Glaeser, checked the address on N 7th St. I found out it was a federally subsidized apartment complex for senior citizens. In speaking to one of the maintenance personnel who was cleaning up snow at the apartment complex, he indicated he was not family with ROSINSKY. He further stated all the parties who reside at this particular complex are over 55 years old.

It appears contact will have to be made with [REDACTED] to make a determination if this DONALD ROSINSKY is the same one she was talking about when she relayed her information.

03/10/99 @ 0900 Hrs.: I attempted to call [REDACTED] but was unsuccessful in making telephone contact. In reference to prior contacts with [REDACTED] it is suggested someone attempt to make contact with her after 1600 hours to get more specific information on DONALD ROSINSKY.

At this time, I will be going on 4 days regular off, and this information will be relayed to Deputy Jost for possible follow-up. EJGlaeser *EJG* /bjc

03/10/99: I, Deputy Jost, was requested to follow-up on this incident by Deputy Glaeser. I was able to make contact with [REDACTED] at her residence at approximately 1900 hours. In talking to [REDACTED], she first of all began describing DONALD as being approximately 5'8", very thin build, estimated 140-150 pounds, short, brown hair, possibly balding on top. She advised DONALD is in his mid-30s and wears glasses. During the wintertime, he normally wears a Chicago Bears jacket. She indicated she believes he works for DALE CARBON at 4 SEASONS LAWN CARE. After talking with [REDACTED] for some time, she told me someone at the bar mentioned his last name was MROZINSKI, not ROSINSKY. In looking in the telephone book, she found a subject with the last name MROZINSKI and the phone number matching the number she had in her log book. It is believed DONALD MROZINSKI may reside at this residence with his father at [REDACTED] N CTH S, Cato.

Due to the lateness in my shift, I (Deputy Jost) was unable to attempt contact with MROZINSKI. Further follow-up will need to be done in order to make contact with MROZINSKI.
JMJost /bjc

0 MROZINSKI ALVIN V [REDACTED] [REDACTED] N CTH S, Cato [REDACTED]

03/15/99 @ 0645 Hrs.: I, Deputy E. Glaeser, made telephone contact with DONALD MROZINSKI. I informed him that I needed to speak with him reference this investigation.

03/15/99 @ 0710 Hrs.: I met with DONALD MROZINSKI at his residence on CTH S. DONALD was very cooperative. He told me he was familiar with both DEBRA WETENKAMP and RICHARD (RICK) HOCHSTETLER as he had worked with both of them at MANITOWOC SHIPBUILDING and the BIL-MAR in the past. DONALD stated he was quite upset when he heard about RICK being run over by a

MANITOWOC COUNTY SHERIFF'S DEPARTMENT
FOLLOW-UP REPORT

Page: 4

CASE NUMBER: 599-01741 CLASSIFICATION: _____

INCIDENT: _____

DATE AND TIME: _____

REPORT CONTINUED:

regard to this accident. He told me he did not know anything at all and that he heard from his father, ALVIN MROZINSKI, that RICK was walking along CTH CR prior to being struck by the hit and run vehicle. DONALD stated his father (ALVIN) was tending bar in the early morning hours prior to RICK being run over. DONALD stated his father did see RICK walking along CTH CR in what just would have been minutes before the accident happened.

ALVIN was present at the residence, and he told me he did have the occasion to speak with a male and female officer of MTSO. He told them he did see RICK walking along CTH CR at approximately 0210 hours when he left the BIL-MAR. ALVIN said, when he left the BIL-MAR, the place was closed up, and there were very few, if any, vehicles left in the parking lot.

DONALD advised he owns 3 vehicles, and he showed me those vehicles in his yard. The one which was described by [REDACTED]--a red GMC 1987 pickup truck displaying WI RP SFZ651-- was checked, and it is not a match for our suspect vehicle. DONALD also showed me a 1986 Chevy Monte Carlo and an older junked 1984 Chevy Blazer which was missing most of its parts. These vehicles were all entered into the Master FBI computer program.

In checking the information brought forward by DONALD, it was consistent with the alpha check which was run on him.

This particular individual, DONALD MROZINSKI, can be eliminated as a suspect. Information on both DONALD and ALVIN were entered into the Master Rapid Start Search computer program.

EJGlaeser

Handwritten: MJD
EVO
CLEAR OUT
bjc

1. CASE # S99 No 01748 | 2. CLASSIFICATION 1031.11 | 3. CENSUS 1410.22

4. INCIDENT CS - S99-00242

5. INCIDENT LOCATION [REDACTED] Center Rd

6. NAME - LAST - FIRST - MI [REDACTED] 7. D.O.B. [REDACTED]

8. ADDRESS [REDACTED] 9. TX-HOME [REDACTED]

11. CITY STATE ZIP 10. TX-BUSINESS [REDACTED]

12. DETAILS See Attached

REC'D 14. 15. 16. 17.
DISP 10-23 10-24
13. DAY
SUN 1 THU 5
MON 2 FRI 6
TUE 3 SAT 7
WED 4

MANITOWOC COUNTY SHERIFF
INCIDENT CARD

18 ASSIGNED 929
Bushman H.H.H.

19. REC. BY 20. DIS. BY 22. TYPE OF REPORT
135 1 INCIDENT
2 ACCIDENT
3 CITATION
4 NONE
21. HOW REC'D.
1. 911
2. POLICE RADIO
3. PHONE
4. TTY
5. IN PERSON
6. ON VIEW
7. OFF. OFF DUTY
8. C.B. RADIO
9. OTHER
23. STATUS
1. UNFOUNDED
2. PNL
3. OTHER
4. CLEARED
5. EXCEPT CLEARED
24. DATE CLEARED 03/08/99
25. OFFENSE TYPE
1. ADULT NA
2. JUVENILE
3. UNKNOWN

39. (CODE S-SUSPECT W-WITNESS V-VICTIM O-OTHER)				
CODE	40. NAME-LAST FIRST MI	41. D.O.B.	42. ADDRESS	43. TELEPHONE
0	Ayotte, Michael R. 30041	[REDACTED]	[REDACTED] Center Rd., Mtwc	[REDACTED]

03/04/99 1520hrs Contact made in person with Michael Ayotte [REDACTED] Center Road. I introduced myself and told him what the complaint I was working on was about. He stated he does have a van and pointed to a tan Ford van parked in the yard near a very large storage shed. He stated that is the only van he owns and has had it 4-5 years buying from his mother who owns "Flowers by Us". A faint faded spot where the sign once was is visible. Expired registration is BG26272.

Ayotte stated he does not drive the truck in winter because it has very poor traction and infact he had just rolled it out of the storage two days ago. He drives several other winter beaters when the snow flys. He stated he has never owned a Chev.van. Close out this complaint.M.J.Bushman

45. IF COMPLAINANT DIFFERENT THEN CALLER, ENTER NAME, ADDRESS, D.O.B., TELEPHONE.

46. IF CODE O (OTHER) IS USED IN FIELD #39, EXPLAIN.

INCIDENT REPORT: NOTE: IF SECTION 22 ABOVE HAS NUMBER 4 CHECKED, DO NOT GO BEYOND THIS LINE WITHOUT RECORDS SECTION BEING ADVISED, OR NO RECORD ENTRIES WILL BE MADE BELOW THIS LINE.

PROPERTY VALUE	26. PROPERTY	A. CURRENCY	B. JEWELRY	C. FURS CLOTHING	D. VEHICLE (LOCAL)	E. OFFICE EQUIPMENT	F. RADIO, TV CAMERAS	G. FIREARMS	H. HOUSE-HOLD GOODS
	STOLEN	\$	\$	\$	\$	\$	\$	\$	\$
	RECOVERED	\$	\$	\$	\$	\$	\$	\$	\$
	26. PROPERTY	I. CONSUMABLES	J. LIVESTOCK	K. DRUGS	L. MARINE ITEMS	M. CONSTRUCTION ITEMS	N. LAWN AND GARDEN	O. SPORTING GOODS	P. MISC BICYCLE
STOLEN	\$	\$	\$	\$	\$	\$	\$	\$	
RECOVERED	\$	\$	\$	\$	\$	\$	\$	\$	

27. PROPERTY RECOVERED: LOCALLY _____ OTHER JURISDICTION _____ (INSERT O OR L)

PROPERTY ITEMIZATION	PROPERTY STOLEN/RECOVERED ITEMIZATION, USE THE FOLLOWING FORMAT				
	28. QUANTITY	29. ARTICLE NAME	30. BRAND NAME	31. SERIAL NUMBER	32. CODE
					S <input type="checkbox"/> R <input type="checkbox"/>
					S <input type="checkbox"/> R <input type="checkbox"/>
					S <input type="checkbox"/> R <input type="checkbox"/>
					S <input type="checkbox"/> R <input type="checkbox"/>

33. PROPERTY DAMAGE AMOUNT \$ _____ 34. INSURANCE COMPANY _____

35. OFFICER ASSAULTED Y N 36. ARSON Y N 37. STRUCTURE CODE _____ 38. DAMAGE \$ _____

47. CIB ENTERED CANCELLED
 NCIC
 OTHER BROADCAST

48. TOTAL AMOUNT PROPERTY STOLEN \$ _____
 49. TOTAL AMOUNT PROPERTY RECOVERED \$ _____

50. IS REPORT CONTINUED? YES NO

51. CAUTION INDICATORS, ATLS ETC.

52. DATA PROCESS INFORMATION:
 COMPUTER ENTERED DATE 13.5.99
 MICROFILM INDEXED INITIAL KS
 IS CASE CLASSIFICATION CORRECT? N
 IF N HAS CORRECTION BEEN MADE? N

53. FILE APPROVAL
 BY [Signature] DATE 030899

B
G 26272 99

4.5 YEARS FORD VAN
NO TRACTION IN WINTER

HAS WINTER TIRES

FLAME BY BIKE

NEVER HAS CHEV. VAN

1. CASE # S99 No 01750 | 2. CLASSIFICATION 0.310.11 | 3. CENSUS 0.910.07

4. INCIDENT CS / S99-00242

5. INCIDENT LOCATION CTH CK

NAME - LAST - FIRST - MI Ambny. (2) 7. D.O.B.

8. ADDRESS 9. TX-HOME

11. CITY STATE ZIP 10. TX-BUSINESS

12. DETAILS
 RAS. A CHEN TK w/ DAMAGE
 PARKED two doors down from
 Action Cycle (South). No further
 INFO. provided.

1431
03-01-99

13. DAY
 SUN 1 THU 5
 MON 2 FRI 6
 TUE 3 SAT 7
 WED 4

MANITOWOC COUNTY SHERIFF
INCIDENT CARD

18. ASSIGNED
 COLAESC 4117
 MISO 938

19. REC. BY 20. DIS BY
 938

22. TYPE OF REPORT
 1. INCIDENT
 2. ACCIDENT
 3. CITATION
 4. NONE

21. HOW REC'D.
 1. 911
 2. POLICE RADIO
 3. PHONE
 4. TTY
 5. IN PERSON
 6. ON VIEW
 7. OFF. OFF DUTY
 8. C.B. RADIO
 9. OTHER

23. STATUS
 1. UNFOUNDED
 2. PNL
 3. OTHER
 4. CLEARED
 5. EXCEPT CLEARED

21A. M.O.

24. DATE CLEARED 03 02 99
 25. OFFENSE TYPE
 1. ADULT NA
 2. JUVENILE
 3. UNKNOWN

39. (CODE S-SUSPECT W-WITNESS V-VICTIM O-OTHER) 40. NAME-LAST FIRST MI 41. D.O.B. 42. ADDRESS 43. TELEPHONE

CODE	40. NAME-LAST	FIRST	MI	41. D.O.B.	42. ADDRESS	43. TELEPHONE

03-01-99 Spoke with Deputy Glaeser, he stated that this veh. comes back to a Hubbartt and was checked by him. It would not match suspect veh. and incident can be closed out. 938/KB

45. IF COMPLAINANT DIFFERENT THEN CALLER, ENTER NAME, ADDRESS, D.O.B., TELEPHONE.

46. IF CODE O (OTHER) IS USED IN FIELD #39, EXPLAIN.

INCIDENT REPORT: NOTE: IF SECTION 22 ABOVE HAS NUMBER 4 CHECKED, DO NOT GO BEYOND THIS LINE WITHOUT RECORDS SECTION BEING ADVISED, OR NO RECORD ENTRIES WILL BE MADE BELOW THIS LINE.

PROPERTY VALUE	26. PROPERTY	A. CURRENCY	B. JEWELRY	C. FURS CLOTHING	D. VEHICLE (LOCAL)	E. OFFICE EQUIPMENT	F. RADIO, TV CAMERAS	G. FIREARMS	H. HOUSE-HOLD GOODS
	STOLEN	\$	\$	\$	\$	\$	\$	\$	\$
	RECOVERED	\$	\$	\$	\$	\$	\$	\$	\$
	26. PROPERTY	I. CONSUM-ABLES	J. LIVESTOCK	K. DRUGS	L. MARINE ITEMS	M. CONSTRUCTION ITEMS	N. LAWN AND GARDEN	O. SPORTING GOODS	P. MISC BICYCLE
STOLEN	\$	\$	\$	\$	\$	\$	\$	\$	
RECOVERED	\$	\$	\$	\$	\$	\$	\$	\$	

27. PROPERTY RECOVERED: LOCALLY _____ OTHER JURISDICTION _____ (INSERT O OR L)

PROPERTY ITEMIZATION	PROPERTY STOLEN/RECOVERED ITEMIZATION, USE THE FOLLOWING FORMAT			
	28. QUANTITY	29. ARTICLE NAME	30. BRAND NAME	31. SERIAL NUMBER
				32. CODE S R <input type="checkbox"/> <input type="checkbox"/>
				S R <input type="checkbox"/> <input type="checkbox"/>
				S R <input type="checkbox"/> <input type="checkbox"/>
				S R <input type="checkbox"/> <input type="checkbox"/>
				S R <input type="checkbox"/> <input type="checkbox"/>
				S R <input type="checkbox"/> <input type="checkbox"/>

33. PROPERTY DAMAGE AMOUNT \$ _____

34. INSURANCE COMPANY _____

35. OFFICER ASSAULTED Y N

36. ARSON Y N

37. STRUCTURE CODE _____

38. DAMAGE \$ _____

47. CIB ENTERED CANCELLED
 NCIC
 OTHER BROADCAST

48. TOTAL AMOUNT PROPERTY STOLEN \$ _____

49. TOTAL AMOUNT PROPERTY RECOVERED \$ _____

50. IS REPORT CONTINUED? YES NO

51. CAUTION INDICATORS, ATLS ETC.

52. DATA PROCESS INFORMATION:

COMPUTER ENTERED DATE 5.8.99
 MICROFILM INDEXED INITIAL AS

53. FILE APPROVAL

IS CASE CLASSIFICATION CORRECT?
 IF N HAS CORRECTION BEEN MADE? Y N

BY [Signature] DATE 03/02/99

CASE # S99 No 01749 2. CLASSIFICATION 030.11 3. CENSUS 7.010.00

4. INCIDENT CS / S99-00242

5. INCIDENT LOCATION MARINETTE CO.

6. NAME - LAST - FIRST - MI ANONY. (2) 7. D.O.B.

8. ADDRESS 9. TX-HOME

11. CITY STATE ZIP 10. TX-BUSINESS

12. DETAILS See Attached

2ND COMPLAINT # S99-01832

1517
03-01-99

**MANITOWOC COUNTY SHERIFF
INCIDENT CARD**

18. ASSIGNED BUSHMAN 4141
929

19. REC. BY 930 20. DIS. BY

21. HOW REC'D.
1. 911
2. POLICE RADIO
3. PHONE
4. TTY
5. IN PERSON
6. ON VIEW
7. OFF. OFF DUTY
8. C.B. RADIO
9. OTHER

22. TYPE OF REPORT
1. INCIDENT
2. ACCIDENT
3. CITATION
4. NONE

23. STATUS
1. UNFOUNDED
2. PNL
3. OTHER
4. CLEARED
5. EXCEPT CLEARED

24. DATE CLEARED 03/16/99

25. OFFENSE TYPE
1. ADULT NA
2. JUVENILE
3. UNKNOWN

13. DAY
SUN 1 THU 5
MON 2 FRI 6
TUE 3 SAT 7
WED 4

39. (CODE S-SUSPECT W-WITNESS V-VICTIM O-OTHER)						
CODE	40. NAME - LAST	FIRST	MI	41. D.O.B.	42. ADDRESS	43. TELEPHONE
0	Kirk, Richard F				████████ Meadow Ln, Crivitz, Wi	████████
0	Marinette Co.	SO				████████

03/04/99 1013hrs Contact made with Marinette Co. SO. The address given is in the County and they will check the vehicle for MISO. There was no officer close at this time, it may be later in the day. Instructions given for officer to call me at MISO for details of damage while at the vehicle.

Attempted contact by phone with Kirk, no answer. M.J. Bushman

03/05/99 1515hrs Contact made by phone with Marinette SO, An officer checked 3/4 1102hrs and 3/5 0900hrs, unable to locate vehicle, will try again. M.J. Bushman

03/11/99 Response received from Marinette in the form of a report Case# 99-1258. Vehicle was checked and owner interviewed, report attached, this can be closed. M.J. Bushman

S99 No 01749

45. IF COMPLAINANT DIFFERENT THEN CALLER, ENTER NAME, ADDRESS, D.O.B., TELEPHONE.

46. IF CODE O (OTHER) IS USED IN FIELD #39, EXPLAIN.

INCIDENT REPORT: NOTE: IF SECTION 22 ABOVE HAS NUMBER 4 CHECKED, DO NOT GO BEYOND THIS LINE WITHOUT RECORDS SECTION BEING ADVISED. OR NO RECORD ENTRIES WILL BE MADE BELOW THIS LINE.

PROPERTY VALUE	26. PROPERTY	A. CURRENCY	B. JEWELRY	C. FURS CLOTHING	D. VEHICLE (LOCAL)	E. OFFICE EQUIPMENT	F. RADIO, TV CAMERAS	G. FIREARMS	H. HOUSE-HOLD GOODS
	STOLEN	\$	\$	\$	\$	\$	\$	\$	\$
	RECOVERED	\$	\$	\$	\$	\$	\$	\$	\$
	26. PROPERTY	I. CONSUM-ABLES	J. LIVESTOCK	K. DRUGS	L. MARINE ITEMS	M. CONSTRUCTION ITEMS	N. LAWN AND GARDEN	O. SPORTING GOODS	P. MISC BICYCLE
STOLEN	\$	\$	\$	\$	\$	\$	\$	\$	
RECOVERED	\$	\$	\$	\$	\$	\$	\$	\$	

27. PROPERTY RECOVERED: LOCALLY _____ OTHER JURISDICTION _____ (INSERT O OR L)

PROPERTY ITEMIZATION	PROPERTY STOLEN/RECOVERED ITEMIZATION, USE THE FOLLOWING FORMAT				31. SERIAL NUMBER	32. CODE
	28. QUANTITY	29. ARTICLE NAME	30. BRAND NAME			
						S <input type="checkbox"/> R <input type="checkbox"/>
						S <input type="checkbox"/> R <input type="checkbox"/>
						S <input type="checkbox"/> R <input type="checkbox"/>
						S <input type="checkbox"/> R <input type="checkbox"/>
						S <input type="checkbox"/> R <input type="checkbox"/>
						S <input type="checkbox"/> R <input type="checkbox"/>

33. PROPERTY DAMAGE AMOUNT \$ _____

34. INSURANCE COMPANY _____

35. OFFICER ASSAULTED Y N

36. ARSON Y N

37. STRUCTURE CODE _____

38. DAMAGE \$ _____

47. CIB ENTERED CANCELLED
 NCIC
 OTHER BROADCAST

48. TOTAL AMOUNT PROPERTY STOLEN \$ _____

49. TOTAL AMOUNT PROPERTY RECOVERED \$ _____

50. IS REPORT CONTINUED? YES NO

51. CAUTION INDICATORS, ATLS ETC.

52. DATA PROCESS INFORMATION:

COMPUTER ENTERED DATE 3/16/99
 MICROFILM INDEXED INITIAL RS

53. FILE APPROVAL

IS CASE CLASSIFICATION CORRECT? Y N
 IF N HAS CORRECTION BEEN MADE? Y N

BY RS DATE 03/16/99

IMPORTANT MESSAGE

FOR ALB

DATE 3/4 TIME 1102 A.M.

M Shirley

OF Marinett Co.

PHONE _____

FAX _____

MOBILE _____

TELEPHONED	<input checked="" type="checkbox"/>	PLEASE CALL	<input type="checkbox"/>
CAME TO SEE YOU	<input type="checkbox"/>	WILL CALL AGAIN	<input type="checkbox"/>
WANTS TO SEE YOU	<input type="checkbox"/>	RUSH	<input type="checkbox"/>
RETURNED YOUR CALL	<input type="checkbox"/>	SPECIAL ATTENTION	<input type="checkbox"/>

MESSAGE office did rise - no one home. Vehicle that was there wasn't the right one. Will check again later.

SIGNED Shirley

Marinette County Sheriff's Department

██████ Ella Court

Marinette, WI 54143

Telephone... ████████Fax.... ████████

Supplemental Report

Case #99-1258

Date: 03/06/99

Reporting Officer: B A Degnitz

Narrative:

On 03/06/99, I was trying to locate a person and vehicle for the Manitowoc County Sheriff's Department regarding their case s99-00242. I was trying to locate a Richard Kirk and a 1988 Chevrolet pickup truck bearing Wisconsin annual truck registration BJ83759. I had spoken to Kirk's mother. She described to me where he lives. I was unable to locate him.

Later, Kirk called into the Sheriff's Department to set up a meeting with me. I did meet :

Richard F. Kirk m/w ████████

██████ CTH A

Crivitz, WI 54114 Cell# ████████

I spoke with Kirk regarding his pickup truck and its possible involvement with Manitowoc County's case. He told me he does own a 1988 Chevrolet pickup truck bearing Wisconsin annual truck registration BJ83759. He said the truck does have some front end damage. He told me that he struck a deer with the truck. This occurred on 12/23/98 at about 1630 to 1700 on CTH P about 1/2 mile east of CTH W in the town of Beaver in Marinette County. He said he did not call in the accident, but it was witnessed by a resident near the accident location. He said that he had heard of the incident in Manitowoc County, but he was not involved. He said he had done some repairs to the vehicle himself. He had mounted some driving lights with some clamps for driving purposes. He also had wired up his directional wires and put colored bulbs in.

I inspected the front end damage to the vehicle. I noticed extensive grill damage. About the 1/3 passenger side was missing, but the full Chevrolet emblem was present. The passenger side light assembly was missing. There was a small kink in the hood about one foot from the far passenger side. The kink was about one inch deep and angular, not rounded. The fan shroud was intact and looked original due to aging. There was also passenger side front fender damage consistent with a deer hit when the deer whips around. This damage was not entirely consistent with what Manitowoc County was looking for.

Kirk said that he had been involved, he would have repaired the damage a long time ago. He

said that if necessary, he would be willing to drive to Manitowoc to clear himself.

I do not believe that this is the vehicle involved. Kirk was very cooperative and seemed to be truthful from his non-verbal communication.

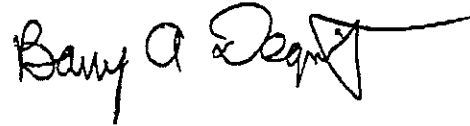
A handwritten signature in black ink that reads "Barry A Dognitz". The signature is written in a cursive style with a long horizontal line extending to the right from the end of the name.

Deputy Barry A Dognitz

1. CASE # **S99 No 01812** | 2. CLASSIFICATION **6.310.11** | 3. CENSUS **3.81000**

4. INCIDENT **CS/S99-00242**

5. INCIDENT LOCATION **TNS PHONE CO.**

6. NAME - LAST - FIRST - MI **VALDERS PD** | 7. D.O.B

8. ADDRESS **Valders PD** | 9. TX-HOME

11. CITY **Valders** | STATE **WI** | ZIP **54981** | 10. TX-BUSINESS

12. DETAILS
RETS. Seeing party at Newton Meats
the Saturday after accident selling
A van to butcher. The seller
stated "He needed to get rid of it."

1441
03-05-99

14. REC'D.	15. DISP.	16. 10-23	17. 10-24
13. DAY			
SUN 1	THU 5		
MON 2	FRI 6		
TUE 3	SAT 7		
WED 4			

MANITOWOC COUNTY SHERIFF INCIDENT CARD

18. ASSIGNED
Lt. BUSHMAN | **4441**
COLBORN | **KIESO**
929

19. REC. BY 93E	20. DIS. BY	22. TYPE OF REPORT <input checked="" type="radio"/> 1. INCIDENT <input type="radio"/> 2. ACCIDENT <input type="radio"/> 3. CITATION <input type="radio"/> 4. NONE
21. HOW REC'D. <input checked="" type="checkbox"/> 1. 911 <input checked="" type="checkbox"/> 2. POLICE RADIO <input checked="" type="checkbox"/> 3. PHONE <input type="checkbox"/> 4. TTY <input type="checkbox"/> 5. IN PERSON <input type="checkbox"/> 6. ON VIEW <input type="checkbox"/> 7. OFF. OFF DUTY <input type="checkbox"/> 8. C.B. RADIO <input type="checkbox"/> 9. OTHER		23. STATUS <input type="checkbox"/> 1. UNFOUNDED <input type="checkbox"/> 2. RNL <input checked="" type="checkbox"/> 3. OTHER <input type="checkbox"/> 4. CLEARED <input type="checkbox"/> 5. EXCEPT CLEARED
21A.M.O.		24. DATE CLEARED 03/16/99
		25. OFFENSE TYPE <input type="checkbox"/> 1. ADULT <input type="checkbox"/> NA <input type="checkbox"/> <input type="checkbox"/> 2. JUVENILE <input type="checkbox"/> <input type="checkbox"/> 3. UNKNOWN <input type="checkbox"/>

39. (CODE S-SUSPECT W-WITNESS V-VICTIM O-OTHER)	40. NAME-LAST	FIRST	MI	41. D.O.B.	42. ADDRESS	43. TELEPHONE
0	[REDACTED]	[REDACTED]	[REDACTED]	[REDACTED]	[REDACTED]	[REDACTED]
0	VANESS	JAMES	J	[REDACTED]	[REDACTED] CTH U. Newton	[REDACTED]
0	VANESS	KAREAN	M	[REDACTED]	[REDACTED] CTH U. Newton	[REDACTED]
0	VANESS	STEVEN	J	[REDACTED]	[REDACTED] CTH U. Newton	[REDACTED]

03/03/99 @ 1530 Hrs.: I, Deputy A. Colborn, responded to [REDACTED] place of employment in the Village of Valders. Preliminary information received from MTSO Dispatch was that [REDACTED] called and reported that the butcher at NEWTON MEAT MARKET was observed attempting to sell a vehicle which apparently had front end damage. Further information received was that the butcher was attempting to sell this vehicle in close proximity to the date of the fatal hit and run (incident S99-00242).

Upon making contact with [REDACTED], she stated, on Saturday, one week after the fatal hit and run, she was at NEWTON MEAT MARKET to purchase meat. This would have been on 01/16/99. [REDACTED] stated, while she was there, she overheard a conversation between the butcher at NEWTON MEAT MARKET and a customer. [REDACTED] stated the butcher who she identified as a tall, heavy-set, white male was telling a customer he had a van for sale. [REDACTED] stated the butcher informed the customer the van had suffered front end damage and would need the bumper, headlight, and grill replaced. [REDACTED] stated the butcher seemed very anxious to sell the vehicle and stated he would "let the vehicle go for \$1000."

[REDACTED] stated she thought the vehicle may be stored at KIESOW'S AUTO SALVAGE YARD on CTH C. [REDACTED] stated, during the conversation, the butcher mentioned to the male customer that the vehicle was "out on C, you know where it is."

I then responded to KIESOW'S AUTO SALVAGE YARD but was unable to locate the proprietor at this time.

Deputy Weyker responded to NEWTON MEAT MARKET where he made contact with KAREAN and JAMES-VANESS. JAMES stated he was trying to sell a Chevrolet van but had since changed his mind and had the van repaired. JAMES and KAREAN both stated the van had been in an accident and that their son, STEVEN VANESS, was the operator of the van when it was in the accident. Both KAREAN and JAMES stated the accident was reported to MTSO and was incident S99-00464.

KAREAN and JAMES showed the van to Deputy Weyker which turned out to be a white 1990 Chevy Astro van. This vehicle was bearing WI RP AJ53138.

S99 No 01812

45. IF COMPLAINANT DIFFERENT THEN CALLER, ENTER NAME, ADDRESS, D.O.B., TELEPHONE.

46. IF CODE O (OTHER) IS USED IN FIELD #39, EXPLAIN.

INCIDENT REPORT: NOTE: IF SECTION 22 ABOVE HAS NUMBER 4 CHECKED, DO NOT GO BEYOND THIS LINE WITHOUT RECORDS SECTION BEING ADVISED, OR NO RECORD ENTRIES WILL BE MADE BELOW THIS LINE.

PROPERTY VALUE	26. PROPERTY	A. CURRENCY	B. JEWELRY	C. FURS CLOTHING	D. VEHICLE (LOCAL)	E. OFFICE EQUIPMENT	F. RADIO, TV CAMERAS	G. FIREARMS	H. HOUSE-HOLD GOODS
	STOLEN	\$	\$	\$	\$	\$	\$	\$	\$
	RECOVERED	\$	\$	\$	\$	\$	\$	\$	\$
	26. PROPERTY	I. CONSUM-ABLES	J. LIVESTOCK	K. DRUGS	L. MARINE ITEMS	M. CONSTRUCTION ITEMS	N. LAWN AND GARDEN	O. SPORTING GOODS	P. MISC BICYCLE
	STOLEN	\$	\$	\$	\$	\$	\$	\$	\$
	RECOVERED	\$	\$	\$	\$	\$	\$	\$	\$

27. PROPERTY RECOVERED: LOCALLY _____ OTHER JURISDICTION _____ (INSERT O OR L)

PROPERTY ITEMIZATION	PROPERTY STOLEN/RECOVERED ITEMIZATION, USE THE FOLLOWING FORMAT				
	28. QUANTITY	29. ARTICLE NAME	30. BRAND NAME	31. SERIAL NUMBER	32. CODE
					S R <input type="checkbox"/> <input type="checkbox"/>
					S R <input type="checkbox"/> <input type="checkbox"/>
					S R <input type="checkbox"/> <input type="checkbox"/>
					S R <input type="checkbox"/> <input type="checkbox"/>

33. PROPERTY DAMAGE AMOUNT \$ _____

34. INSURANCE COMPANY _____

35. OFFICER ASSAULTED Y N

36. ARSON Y N

37. STRUCTURE CODE _____

38. DAMAGE \$ _____

47. CIB ENTERED CANCELLED
 NCIC
 OTHER BROADCAST

48. TOTAL AMOUNT PROPERTY STOLEN \$ _____

49. TOTAL AMOUNT PROPERTY RECOVERED \$ _____

50. IS REPORT CONTINUED? YES NO

51. CAUTION INDICATORS, ATLS ETC.

52. DATA PROCESS INFORMATION:

COMPUTER ENTERED DATE
 MICROFILM INDEXED INITIAL _____

53. FILE APPROVAL

IS CASE CLASSIFICATION CORRECT? Y N
 IF N HAS CORRECTION BEEN MADE? Y N

BY WBS DATE 03/18/89

MANITOWOC COUNTY SHERIFF'S DEPARTMENT
FOLLOW-UP REPORT

Page: 2

CASE NUMBER: 599-01812 CLASSIFICATION: _____

INCIDENT: _____

DATE AND TIME: _____

REPORT CONTINUED:

The Chevy Astro van is a mini-van; therefore, does not match our suspect vehicle. The suspect vehicle in the hit and run could possible be a Chevy van; however, it would be a full-sized Chevrolet van.

This incident does not appear at this time to be the vehicle involved in the fatal hit and run. Upon completion of typing, a copy of this incident should be forwarded to Lt. M. Bushman for his review as well as to Deputy Raube for entry into the FBI Rapid Start computer program. No further action taken at this time. ALColborn /bjc

INCIDENT
 CS/599-00242

5. INCIDENT LOCATION
 N on Calomet Dr Sheboygan

6. NAME- LAST-FIRST-MI
 [REDACTED] 7. D.O.B. [REDACTED]

8. ADDRESS [REDACTED]
 9. TX-HOME [REDACTED]
 10. TX-BUSINESS [REDACTED]

12. DETAILS
 Veh. seen in Sheboygan
 short time ago on Calomet Dr.
 w/ grill + new front bumper on veh
 not matching colors on dark gray Chev.

030499 0915

INCIDENT CARD

18. ASSIGNED
 MTSD CS 9219
 BONFIGT 4510

19. REC. BY 923
 20. DIS. BY

21. HOW REC'D.
 1. 911
 2. POLICE RADIO
 3. PHONE
 4. TTY
 5. IN PERSON
 6. ON VIEW
 7. OFF. OFF DUTY
 8. C.B. RADIO
 9. OTHER

22. TYPE OF REPORT
 1. INCIDENT
 2. ACCIDENT
 3. CITATION
 4. NONE

23. STATUS
 1. UNFOUNDED
 2. PNL
 3. OTHER
 4. CLEARED
 5. EXCEPT CLEARED

24. DATE CLEARED 03/08/99

25. OFFENSE TYPE
 1. ADULT NA
 2. JUVENILE
 3. UNKNOWN

39. (CODE S-SUSPECT W-WITNESS V-VICTIM O-OTHER)
 CODE: 0
 40. NAME-LAST FIRST MI 41. D.O.B. 42. ADDRESS 43. TELEPHONE
 Fleisner, Noland F. 35321 [REDACTED] Edgewood St., Cleveland

03/04/99 0935hrs Off. Bonfigt did find the vehicle at the residence and noted it indeed had been repaired recently. There was a replacement grille and the Rt. quarter panel and hood had been painted. It was an 86 Chev with single headlamps on each side, the type vehicle we are looking for. No one home at this time. Cleveland 75 asked to check back periodically during the day and attempt contact with owner for explanation. M.J. Bushman

1042hrs Off. Bonfigt called back. Looking closely at the vehicle it was noted both quarter panels had been replaced, and the paint most notably the passenger side of the hood has runs as if it had been repaired by someone not greatly skilled. Tires are Good Year 7 inch wide, bumper height average stock, rear axle 61". 75 contacted by phone, good explanation of damage needed. M.J. Bushman

03/04/99 1545hrs It was learned Noland Fleisner works for Briggess of Sheboygan driving school bus. His employer advised he will not be in to work for 6-8 weeks as he has surgery this afternoon.

I, Lt. Bushman, went to check if anyone else was in the residence at this time. As I pulled up and looked the vehicle checking the registration it was observed the vehicle in question is an S-10 blazer, not fitting the description of the suspect vehicle. Complaint can be closed out. M.J. Bushman

15. IF COMPLAINANT DIFFERENT THEN CALLER, ENTER NAME, ADDRESS, D.O.B., TELEPHONE.

46. IF CODE O (OTHER) IS USED IN FIELD #39, EXPLAIN.

INCIDENT REPORT: NOTE: IF SECTION 22 ABOVE HAS NUMBER 4 CHECKED, DO NOT GO BEYOND THIS LINE WITHOUT RECORDS SECTION BEING ADVISED, OR NO RECORD ENTRIES WILL BE MADE BELOW THIS LINE.

26. PROPERTY	A. CURRENCY	B. JEWELRY	C. FURS CLOTHING	D. VEHICLE (LOCAL)	E. OFFICE EQUIPMENT	F. RADIO, TV, CAMERAS	G. FIREARMS	H. HOUSE-HOLD GOODS
STOLEN	\$	\$	\$	\$	\$	\$	\$	\$
RECOVERED	\$	\$	\$	\$	\$	\$	\$	\$
26. PROPERTY	I. CONSUMABLES	J. LIVESTOCK	K. DRUGS	L. MARINE ITEMS	M. CONSTRUCTION ITEMS	N. LAWN AND GARDEN	O. SPORTING GOODS	P. MISC BICYCLE
STOLEN	\$	\$	\$	\$	\$	\$	\$	\$
RECOVERED	\$	\$	\$	\$	\$	\$	\$	\$

27. PROPERTY RECOVERED: LOCALLY _____ OTHER JURISDICTION _____ (INSERT O OR L)

PROPERTY ITEMIZATION	PROPERTY STOLEN/RECOVERED ITEMIZATION, USE THE FOLLOWING FORMAT			31. SERIAL NUMBER	32. CODE	
	28. QUANTITY	29. ARTICLE NAME	30. BRAND NAME		S	R
					<input type="checkbox"/>	<input type="checkbox"/>
					<input type="checkbox"/>	<input type="checkbox"/>
					<input type="checkbox"/>	<input type="checkbox"/>
					<input type="checkbox"/>	<input type="checkbox"/>
					<input type="checkbox"/>	<input type="checkbox"/>
					<input type="checkbox"/>	<input type="checkbox"/>

33. PROPERTY DAMAGE AMOUNT \$ _____ 34. INSURANCE COMPANY _____

35. OFFICER ASSAULTED Y N 36. ARSON Y N 37. STRUCTURE CODE _____ 38. DAMAGE \$ _____

47. CIB ENTERED CANCELLED
 NCIC
 OTHER BROADCAST

48. TOTAL AMOUNT PROPERTY STOLEN \$ _____

49. TOTAL AMOUNT PROPERTY RECOVERED \$ _____

51. CAUTION INDICATORS, ATLS ETC.

50. IS REPORT CONTINUED? YES NO

52. DATA PROCESS INFORMATION:
 COMPUTER ENTERED DATE 13, 89
 MICROFILM INDEXED INITIAL AS
 IS CASE CLASSIFICATION CORRECT? N
 IF N HAS CORRECTION BEEN MADE? N

53. FILE APPROVAL
 BY [Signature] DATE 12/89
 MCSD 028 1/91

1. CASE # S99 No 01744 2. CLASSIFICATION 631011 3. CENSUS 141002

MANITOWOC COUNTY SHERIFF
INCIDENT CARD
18. ASSIGNED Glaeser 1140
MTSO 929

INCIDENT CS S99-00242

5. INCIDENT LOCATION

6. NAME- LAST-FIRST-MI 7. D.O.B.
Anonyms

8. ADDRESS 9. TX-HOME

11. CITY STATE ZIP 10. TX-BUSINESS

12. DETAILS see attached

31199 1140
14. REC'D. 15. DISP 16. 10-23 17. 10-24
13. DAY
SUN 1 THU 5
MON 2 FRI 6
TUE 3 SAT 7
WED 4

19. REC. BY 921 20. DIS. BY
21. HOW REC'D.
1. 911
2. POLICE RADIO
3. PHONE
4. TTY
5. IN PERSON
6. ON VIEW
7. OFF. OFF DUTY
8. C.B. RADIO
9. OTHER
21A. M.O.
22. TYPE OF REPORT
1. INCIDENT
2. ACCIDENT
3. CITATION
4. NONE
23. STATUS
1. UNFOUNDED
2. PNL
3. OTHER
4. CLEARED
5. EXCEPT CLEARED
24. DATE CLEARED 03/16/99
25. OFFENSE TYPE
1. ADULT NA
2. JUVENILE
3. UNKNOWN

39. (CODE S-SUSPECT W-WITNESS V-VICTIM O-OTHER)							
CODE	40. NAME-LAST	FIRST	MI	41. D.O.B.	42. ADDRESS	43. TELEPHONE	
O	WOLKE	GUY	R		1/2 1st St. Menasha 54952		
O	SIPPEL	DANIEL	J		W Morningside Dr. Kaukauna 54130		

03/01/99 @ 1140 Hrs.: I, Deputy E. Glaeser, spoke to an anonymous caller who stated her ex-husband recently traded in his black Chevy Blazer. The anonymous caller felt we should check into the possibility of this being the hit and run vehicle. According to the party, [redacted] had a 1986-1987 Blazer, black in color, and is now driving a Ford pickup truck. The caller stated her [redacted] is a "nasty man" who is definitely the "type that would do something like this." The caller further stated she was informed by [redacted] recently got rid of the Blazer. In speaking to the party, she had no other evidence to indicate there was any damage to the vehicle in question. She further stated she just knows he may have something to do with the hit and run.

The only information available on the vehicle in question would be the type and year. The party stated there was some type of ex-Marine RP's on the vehicle. The caller provided the name of GUY WOLKE. She stated he lives in Menasha at [redacted] 1/2 1st St, Menasha.

Due to the fact it was at the end of my shift, I was unable to do follow-up on this incident at this time. Upon my return from days off, I will attempt to make contact with the suspect.

03/05/99 @ 0630 Hrs.: I left a telephone message for GUY WOLKE reference this complaint.

03/05/99 @ 0705 Hrs.: I spoke to GUY WOLKE as he called MTSO. WOLKE was asked if he recently traded in a 1986-1987 Chevy Blazer, black in color, to which he stated he did recently trade in a vehicle with that description. WOLKE told me he traded the car in at GUSTMANN CHEVROLET in Kaukauna, the first part of January 1999.

WOLKE further stated he was not aware of our hit and run investigation. After I explained the type of vehicle we were looking for, he agreed his vehicle fit within the descriptive parameters. WOLKE stated, however, his vehicle sustained no front end damage. He provided the name of DANIEL SIPPEL at GUSTMANN CHEVROLET in Kaukauna as a contact person to verify that there had been no damage on the truck when it was traded in. WOLKE also provided an RP of USMCO1 which stands for United States Marine Corp. WOLKE stated he transferred this RP from the Blazer to his new Ford pickup truck.

S99
NO
01744

45. IF COMPLAINANT DIFFERENT THEN CALLER, ENTER NAME, ADDRESS, D.O.B., TELEPHONE.

46. IF CODE O (OTHER) IS USED IN FIELD #39, EXPLAIN.

INCIDENT REPORT: NOTE: IF SECTION 22 ABOVE HAS NUMBER 4 CHECKED, DO NOT GO BEYOND THIS LINE WITHOUT RECORDS SECTION BEING ADVISED, OR NO RECORD ENTRIES WILL BE MADE BELOW THIS LINE.

PROPERTY VALUE	26. PROPERTY	A. CURRENCY	B. JEWELRY	C. FURS CLOTHING	D. VEHICLE (LOCAL)	E. OFFICE EQUIPMENT	F. RADIO, TV CAMERAS	G. FIREARMS	H. HOUSE-HOLD GOODS
	STOLEN	\$	\$	\$	\$	\$	\$	\$	\$
	RECOVERED	\$	\$	\$	\$	\$	\$	\$	\$
	26. PROPERTY	I. CONSUMABLES	J. LIVESTOCK	K. DRUGS	L. MARINE ITEMS	M. CONSTRUCTION ITEMS	N. LAWN AND GARDEN	O. SPORTING GOODS	P. MISC BICYCLE
STOLEN	\$	\$	\$	\$	\$	\$	\$	\$	
RECOVERED	\$	\$	\$	\$	\$	\$	\$	\$	

27. PROPERTY RECOVERED: LOCALLY ____ OTHER JURISDICTION ____ (INSERT O OR L)

PROPERTY ITEMIZATION	PROPERTY STOLEN/RECOVERED ITEMIZATION, USE THE FOLLOWING FORMAT				31. SERIAL NUMBER	32. CODE
	28. QUANTITY	29. ARTICLE NAME	30. BRAND NAME			
						S <input type="checkbox"/> R <input type="checkbox"/>
						S <input type="checkbox"/> R <input type="checkbox"/>
						S <input type="checkbox"/> R <input type="checkbox"/>
						S <input type="checkbox"/> R <input type="checkbox"/>
						S <input type="checkbox"/> R <input type="checkbox"/>
						S <input type="checkbox"/> R <input type="checkbox"/>

33. PROPERTY DAMAGE AMOUNT \$ _____

34. INSURANCE COMPANY _____

35. OFFICER ASSAULTED Y N

36. ARSON Y N

37. STRUCTURE CODE _____

38. DAMAGE \$ _____

47. CIB ENTERED CANCELLED
 NCIC
 OTHER BROADCAST

48. TOTAL AMOUNT PROPERTY STOLEN \$ _____

49. TOTAL AMOUNT PROPERTY RECOVERED \$ _____

50. IS REPORT CONTINUED? YES NO

51. CAUTION INDICATORS, ATLS ETC.

52. DATA PROCESS INFORMATION:

COMPUTER ENTERED DATE 3/16/99
 MICROFILM INDEXED INITIAL AS

53. FILE APPROVAL

IS CASE CLASSIFICATION CORRECT? N
 IF N HAS CORRECTION BEEN MADE? N

BY [Signature] DATE 03/16/99

MANITOWOC COUNTY SHERIFF'S DEPARTMENT
FOLLOW-UP REPORT

Page: 2

CASE NUMBER: 599-01744 CLASSIFICATION: _____

INCIDENT: _____

DATE AND TIME: _____

REPORT CONTINUED:

03/05/99 @ 1040 Hrs.: I, Deputy Glaeser, made contact with DANIEL SIPPEL at GUSTMANN CHEVROLET in Kaukauna. SIPPEL checked company records which indicated WOLKE traded in a 1986 Chevy Blazer on 01/20/99. SIPPEL stated all of their records indicate there was no front end damage to the vehicle. He even went as far as asking the repair dept. if anything was done to the vehicle before it was sent to auction. The only thing they had to do to the vehicle was check the radiator fluid. SIPPEL stated the vehicle was rusty. He specifically remembers there was no front end damage on it when it was traded in.

No further action needed.

EJGlaeser



/bjc

S99-01744

BLACK

[REDACTED] GOT RID OF HIS BLAZER

PERSONALIZED PLATE XUSMARINE OR
XMARINE

GUY R WOLKE

WOODTIK TAXADERMAY

[REDACTED] 1/2 1ST STREET
HE LIVES IN NEWASHA [REDACTED]

HE IS VERY NASTY MAN + I WOULDN'T
PUT IT PAST HIM - HE USUALLY WON'T
ANSWER THE PHONE

1. CASE # **S99 No 01806** | 2. CLASSIFICATION **630.1** | 3. CENSUS **52000**

4. INCIDENT **Crime Stoppers for S99-00242**

5. INCIDENT LOCATION **City of Manitowoc**

6. NAME - LAST - FIRST - MI **Anon.** | 7. D.O.B.

8. ADDRESS | 9. TX-HOME

11. CITY | STATE | ZIP | 10. TX-BUSINESS

12. DETAILS
Complainant overheard a conversation at their place of employment where several co-workers were discussing the Hit and Run accident. It was their impression some of the co-workers knew more about the incident and were not telling police.

639710

14. REC'D | 15. DISP | 16. 10-23 | 17. 10-24
 13. DAY
 SUN 1 | THU 5
 MON 2 | **FRI 3**
 TUE 3 | SAT 7
 WED 4

MANITOWOC COUNTY SHERIFF INCIDENT CARD

18. ASSIGNED
 Rushman | 4141
 MITSO 929

19. REC. BY **MJB** | 20. DIS. BY **MJB**

21. HOW REC'D.
 1. 911
 2. POLICE RADIO
 3. PHONE
 4. TTY
 5. **IN PERSON**
 6. ON VIEW
 7. OFF. OFF DUTY
 8. C.B. RADIO
 9. OTHER

22. TYPE OF REPORT
 1. **INCIDENT**
 2. ACCIDENT
 3. CITATION
 4. NONE

23. STATUS
 1. UNFOUNDED
 2. PNL
 3. **OTHER**
 4. CLEARED
 5. EXCEPT CLEARED

24. DATE CLEARED **03/08/99**

25. OFFENSE TYPE
 1. ADULT NA
 2. JUVENILE
 3. UNKNOWN

39. (CODE S-SUSPECT W-WITNESS V-VICTIM O-OTHER)	40. NAME-LAST	FIRST	MI	41. D.O.B.	42. ADDRESS	43. TELEPHONE
0	Boldt, Rickey D.	U1223			So. 20th Mtwc	
0	Wilhelm, Charles L.	18992			Franklin Mtwc	none
0	Wilhelm, Lisa L.	6527			Circle Dr. Mtwc	
0	Wilhelm, Joseph M.	15266			Marshal St. Mtwc	

03/02/99 @ 1900 Hrs.: Contact was made with Det. Dick from MTPD who assisted with follow-up. The conversation which is listed on the complaint centered around CHARLES, LISA, and JOSEPH WILHELM and RICKEY BOLDT which took place 4 weeks ago. The comment was overheard, "MORBADY can't turn him in, what about the money?"

03/02/99 @ 2030 Hrs.: Contact was made with RICKEY BOLDT, and an interview took place at his residence. BOLDT recalled several conversations with others listed above about the hit and run accident, usually right after TV or news coverage. He knows and has worked with the WILHELMS for quite some time. During the conversation, BOLDT never once got the impression anyone knew more about the incident. He stated, "I'd turn in my own brother, I could use that money for medical bills. We were just talking about it." BOLDT has provided good information to Det. Dick in the past on a criminal matter. It was Det. Dick's impression that BOLDT would tell us if he suspected one of the others knew more than what they were saying. BOLDT stated he will keep his ears open.

03/02/99 @ 2041 Hrs.: Contact was made with JOSEPH WILHELM at [redacted] Marshall St, Manitowoc, and an interview was conducted in Squad 57. JOSEPH has provided MTPD with information on criminal matters in the past, and that proved to be reliable. JOSEPH was nervous at first and quiet until our business was stated. He then became more open, stating, "That ain't right, killing someone like that and hiding it this long. I wish I knew something. I'd turn the son of a bitch in." JOSEPH recalled the conversation, naming several of the participants. He did not believe anyone had specific information, "just what was on the news."

03/02/99 @ 2045 Hrs.: Attempted contact with CHARLES WILHELM at [redacted] Franklin St, Manitowoc, but no one was home. There was a padlock on the outside of the door.

Contact was made with the downstairs renter. Apparently, they just came back from a semi-truck trip and did not hear anybody upstairs.

03/02/99 @ 2048 Hrs.: Attempted contact with LISA WILHELM at [redacted] Circle Dr, Manitowoc. Her son came to the door and then went to talk with his mother. LISA was in bed and was

CASE # S99 No 01806

45. IF COMPLAINANT DIFFERENT THEN CALLER, ENTER NAME, ADDRESS, D.O.B., TELEPHONE.

46. IF CODE O (OTHER) IS USED IN FIELD #39, EXPLAIN.

INCIDENT REPORT: NOTE: IF SECTION 22 ABOVE HAS NUMBER 4 CHECKED, DO NOT GO BEYOND THIS LINE WITHOUT RECORDS SECTION BEING ADVISED, OR NO RECORD ENTRIES WILL BE MADE BELOW THIS LINE.

PROPERTY VALUE	26. PROPERTY	A. CURRENCY	B. JEWELRY	C. FURS CLOTHING	D. VEHICLE (LOCAL)	E. OFFICE EQUIPMENT	F. RADIO, TV CAMERAS	G. FIREARMS	H. HOUSE-HOLD GOODS
	STOLEN	\$	\$	\$	\$	\$	\$	\$	\$
	RECOVERED	\$	\$	\$	\$	\$	\$	\$	\$
	26. PROPERTY	I. CONSUMABLES	J. LIVESTOCK	K. DRUGS	L. MARINE ITEMS	M. CONSTRUCTION ITEMS	N. LAWN AND GARDEN	O. SPORTING GOODS	P. MISC BICYCLE
	STOLEN	\$	\$	\$	\$	\$	\$	\$	\$
	RECOVERED	\$	\$	\$	\$	\$	\$	\$	\$

27. PROPERTY RECOVERED: LOCALLY _____ OTHER JURISDICTION _____ (INSERT O OR L)

PROPERTY ITEMIZATION	PROPERTY STOLEN/RECOVERED ITEMIZATION, USE THE FOLLOWING FORMAT				
	28. QUANTITY	29. ARTICLE NAME	30. BRAND NAME	31. SERIAL NUMBER	32. CODE
					S R <input type="checkbox"/> <input type="checkbox"/>
					S R <input type="checkbox"/> <input type="checkbox"/>
					S R <input type="checkbox"/> <input type="checkbox"/>
					S R <input type="checkbox"/> <input type="checkbox"/>
					S R <input type="checkbox"/> <input type="checkbox"/>

33. PROPERTY DAMAGE AMOUNT \$ _____ 34. INSURANCE COMPANY _____

35. OFFICER ASSAULTED Y N 36. ARSON Y N 37. STRUCTURE CODE _____ 38. DAMAGE \$ _____

47. CIB	ENTERED <input type="checkbox"/>	CANCELLED <input type="checkbox"/>	48. TOTAL AMOUNT PROPERTY STOLEN \$ _____
NCIC	<input type="checkbox"/>	<input type="checkbox"/>	
OTHER BROADCAST	<input type="checkbox"/>	<input type="checkbox"/>	
			49. TOTAL AMOUNT PROPERTY RECOVERED \$ _____

50. IS REPORT CONTINUED? YES NO

52. DATA PROCESS INFORMATION:

COMPUTER ENTERED DATE 13.8.99
MICROFILM INDEXED INITIAL AS

IS CASE CLASSIFICATION CORRECT? Y N
IF N HAS CORRECTION BEEN MADE? Y N

51. CAUTION INDICATORS, ATLS ETC.

53. FILE APPROVAL
BY [Signature] DATE 13.8.99

MANITOWOC COUNTY SHERIFF'S DEPARTMENT
FOLLOW-UP REPORT

Page: 2

CASE NUMBER: 599-01806 CLASSIFICATION: _____

INCIDENT: _____

DATE AND TIME: _____

REPORT CONTINUED:

not willing to get up at this time.

03/02/99 @ 2053 Hrs.: A second drive-by was done at [redacted] Franklin St, Manitowoc. No lights were on. It did not appear anyone was home.

As CHARLES WILHELM usually moves about town on a bicycle, all downtown bars were checked. No bicycles were parked outside. MJBushman /bjc
03/04/99 1813hrs Contact made with Lisa Wilhelm in person at [redacted] Circle Dr.Mtwc. She was smiling as I walked toward the house and she opened the door. Her emmediate crisis with her daughter is over for now and she had returned to work. Her co-workers had filled her in as to what the police wanted. She did recall the conversation and said it had to do with the owner of the junk yard on W.Custer street. Someone in the group relayed a story the owner of the junk yard told him. Apparently he jokingly told someone else to turn him in, collect the \$25000.00 and then they could slit it. Lisa knew it was a joke and depending when someone came into the conversation it may give the outward appearance she or others actually knew the suspect.

Wilhelm was calm throughout the interview and stated she wished she did have information so she could collect the reward.

This complaint can be closed out.M.J.Bushman

1. CASE # S99 No 01832

2. CLASSIFICATION 6301

3. CENSUS 14002

4. INCIDENT CS S99-00242

5. INCIDENT LOCATION

6. NAME-LAST-FIRST-MI Anonyms

7. D.O.B.

8. ADDRESS

9. TX-HOME

10. TX-BUSINESS

11. CITY STATE ZIP

12. DETAILS see attached

Same as S99-01749

3/4/99 0950

MANITOWOC COUNTY SHERIFF
INCIDENT CARD

18. ASSIGNED Bushman 44/929

19. REC. BY 921

20. DIS. BY

21. HOW REC'D.
 1. 911
 2. POLICE RADIO
 3. PHONE
 4. TTY
 5. IN PERSON
 6. ON VIEW
 7. OFF. OFF DUTY
 8. C.B. RADIO
 9. OTHER

22. TYPE OF REPORT
 1. INCIDENT
 2. ACCIDENT
 3. CITATION
 4. NONE

23. STATUS
 1. UNFOUNDED
 2. PNL
 3. OTHER
 4. CLEARED
 5. EXCEPT CLEARED

24. DATE CLEARED 03/16/99

25. OFFENSE TYPE
 1. ADULT NA
 2. JUVENILE
 3. UNKNOWN

21A. M.O.

14. REC'D	15. DISP	16. 10-23	17. 10-24
13. DAY			
SUN 1	MON 2	TUE 3	WED 4
THU 5	FRI 6	SAT 7	

39. (CODE S-SUSPECT W-WITNESS V-VICTIM O-OTHER)						
CODE	40. NAME-LAST	FIRST	MI	41. D.O.B.	42. ADDRESS	43. TELEPHONE
0	Kirk, Richard F.				█ Meadow Ln., Crivitz, Wi (715)	█

03/04/99 1028hrs Contact attempted with Complainant to determine if vehicle called in is the old or new style. Also this is the same vehicle called in in Complaint S99-01749.

Marinette Co. Sheriff Dept has agreed to make contact with owner M.J. Bushman.

1740hrs Complainant called back when he arrived home and listened to his answering machine. The vehicle he called in was of the newer design, so it is not the style vehicle we're looking for. He then said he was not sure. I'll wait for Marinette Co. to make contact.

03/11/99 REsponse received from Marinette in the form of a report Case # 99-1258. Vehicle was checked and owner interviewed, report attached, this can be closed. M.J. Bushman

45. IF COMPLAINANT DIFFERENT THEN CALLER, ENTER NAME, ADDRESS, D.O.B., TELEPHONE.

46. IF CODE O (OTHER) IS USED IN FIELD #39, EXPLAIN.

INCIDENT REPORT: NOTE: IF SECTION 22 ABOVE HAS NUMBER 4 CHECKED, DO NOT GO BEYOND THIS LINE WITHOUT RECORDS SECTION BEING ADVISED, OR NO RECORD ENTRIES WILL BE MADE BELOW THIS LINE.

PROPERTY VALUE	26. PROPERTY	A. CURRENCY	B. JEWELRY	C. FURS CLOTHING	D. VEHICLE (LOCAL)	E. OFFICE EQUIPMENT	F. RADIO, TV CAMERAS	G. FIREARMS	H. HOUSE-HOLD GOODS
	STOLEN	\$	\$	\$	\$	\$	\$	\$	\$
	RECOVERED	\$	\$	\$	\$	\$	\$	\$	\$
	26. PROPERTY	I. CONSUM-ABLES	J. LIVESTOCK	K. DRUGS	L. MARINE ITEMS	M. CONSTRUCTION ITEMS	N. LAWN AND GARDEN	O. SPORTING GOODS	P. MISC BICYCLE
	STOLEN	\$	\$	\$	\$	\$	\$	\$	\$
	RECOVERED	\$	\$	\$	\$	\$	\$	\$	\$

27. PROPERTY RECOVERED: LOCALLY _____ OTHER JURISDICTION _____ (INSERT O OR L)

PROPERTY ITEMIZATION	PROPERTY STOLEN/RECOVERED ITEMIZATION, USE THE FOLLOWING FORMAT				31. SERIAL NUMBER	32. CODE
	28. QUANTITY	29. ARTICLE NAME	30. BRAND NAME			
						S <input type="checkbox"/> R <input type="checkbox"/>
						S <input type="checkbox"/> R <input type="checkbox"/>
						S <input type="checkbox"/> R <input type="checkbox"/>
						S <input type="checkbox"/> R <input type="checkbox"/>
						S <input type="checkbox"/> R <input type="checkbox"/>
						S <input type="checkbox"/> R <input type="checkbox"/>

33. PROPERTY DAMAGE AMOUNT \$ _____ 34. INSURANCE COMPANY _____

35. OFFICER ASSAULTED Y N 36. ARSON Y N 37. STRUCTURE CODE _____ 38. DAMAGE \$ _____

47. CIB <input type="checkbox"/>	ENTERED <input type="checkbox"/>	CANCELLED <input type="checkbox"/>	48. TOTAL AMOUNT PROPERTY STOLEN \$ _____
NCIC <input type="checkbox"/>	<input type="checkbox"/>	<input type="checkbox"/>	
OTHER BROADCAST <input type="checkbox"/>	<input type="checkbox"/>	<input type="checkbox"/>	
			49. TOTAL AMOUNT PROPERTY RECOVERED \$ _____

50. IS REPORT CONTINUED? YES NO 51. CAUTION INDICATORS, ATLS ETC.

52. DATA PROCESS INFORMATION:

COMPUTER ENTERED DATE 3/16/99

MICROFILM INDEXED INITIAL KS

IS CASE CLASSIFICATION CORRECT? N

IF N HAS CORRECTION BEEN MADE? N

53. FILE APPROVAL

BY [Signature] DATE 03/16/99

Marinette County Sheriff's Department

██████ Ella Court

Marinette, WI 54143

Telephone...(██████████).....Fax....(██████████)

Supplemental Report

Case #99-1258

Date: 03/06/99

Reporting Officer: B A Degnitz

Narrative:

On 03/06/99, I was trying to locate a person and vehicle for the Manitowoc County Sheriff's Department regarding their case #99-00242. I was trying to locate a Richard Kirk and a 1988 Chevrolet pickup truck bearing Wisconsin annual truck registration BJ83759. I had spoken to Kirk's mother. She described to me where he lives. I was unable to locate him.

Later, Kirk called into the Sheriff's Department to set up a meeting with me. I did meet :

Richard F. Kirk m/w ██████

██████ CTH A

Crivitz, WI 54114 Cell# ██████

I spoke with Kirk regarding his pickup truck and its possible involvement with Manitowoc County's case. He told me he does own a 1988 Chevrolet pickup truck bearing Wisconsin annual truck registration BJ83759. He said the truck does have some front end damage. He told me that he struck a deer with the truck. This occurred on 12/23/98 at about 1630 to 1700 on CTH P about 1/2 mile east of CTH W in the town of Beaver in Marinette County. He said he did not call in the accident, but it was witnessed by a resident near the accident location. He said that he had heard of the incident in Manitowoc County, but he was not involved. He said he had done some repairs to the vehicle himself. He had mounted some driving lights with some clamps for driving purposes. He also had wired up his directional wires and put colored bulbs in.

I inspected the front end damage to the vehicle. I noticed extensive grill damage. About the 1/3 passenger side was missing, but the full Chevrolet emblem was present. The passenger side light assembly was missing. There was a small kink in the hood about one foot from the far passenger side. The kink was about one inch deep and angular, not rounded. The fan shroud was intact and looked original due to aging. There was also passenger side front fender damage consistent with a deer hit when the deer whips around. This damage was not entirely consistent with what Manitowoc County was looking for.

Kirk said that he had been involved, he would have repaired the damage a long time ago. He

...said that if necessary, he would be willing to drive to Manitowoc to clear himself.

I do not believe that this is the vehicle involved. Kirk was very cooperative and seemed to be truthful from his non-verbal communication.

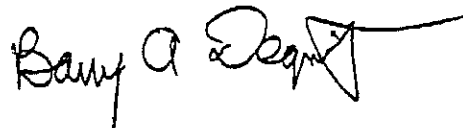
A handwritten signature in black ink that reads "Barry A Degnitz". The signature is written in a cursive style with a long horizontal line extending to the right from the end of the name.

Deputy Barry A Degnitz

1 CASE # S99 No 01846 2. CLASSIFICATION 6,310,11 3. CENSUS 7,010,00

4. INCIDENT CS 1599-00242

5. INCIDENT LOCATION WAUPACA Co.

6. NAME - LAST - FIRST - MI FLEMONT PO 7. D.O.B.

8. ADDRESS 9. TX-HOME

11. CITY STATE ZIP 10. TX-BUSINESS

12. DETAILS See Attached.

1618
030499

MANITOWOC COUNTY SHERIFF INCIDENT CARD

18. ASSIGNED MTSO 938
Lt Bushman HAV

19. REC. BY 938 20. DIS. BY

22. TYPE OF REPORT
1. INCIDENT
2. ACCIDENT
3. CITATION
4. NONE

21. HOW REC'D.
1. 911
2. POLICE RADIO
3. PHONE
4. TTY
5. IN PERSON
6. ON VIEW
7. OFF. OFF DUTY
8. C.B. RADIO
9. OTHER

23. STATUS
1. UNFOUNDED
2. PNL
3. OTHER
4. CLEARED
5. EXCEPT CLEARED

24. DATE CLEARED 03 10 1999

25. OFFENSE TYPE
1. ADULT NA
2. JUVENILE
3. UNKNOWN

21A. M.O.

13. DAY
SUN 1 THU 5
MON 2 FRI 6
TUE 3 SAT 7
WED 4

39. (CODE S-SUSPECT W-WITNESS V-VICTIM O-OTHER)				41. D.O.B.	42. ADDRESS	43. TELEPHONE
CODE	40. NAME-LAST	FIRST	MI			
0	Schumacher Luke S.			176294	██████████ CTH O Appleton	

03/05/99 1500hrs Contact made with Outagamie Co.S.O. The address above is their jurisdiction and they will check vehicle for us iff teletype is sent. M.J. Bushman
1616hrs Outagamie Officer called back and he is sitting right next to the vehicle which was located in the settlement of Dale. It has all the damage listed but the vehicle is an S-10, so does not match out description. Close Out. M.J. Bushman

45. IF COMPLAINANT DIFFERENT THEN CALLER, ENTER NAME, ADDRESS, D.O.B., TELEPHONE.

46. IF CODE O (OTHER) IS USED IN FIELD #39, EXPLAIN.

INCIDENT REPORT: NOTE: IF SECTION 22 ABOVE HAS NUMBER 4 CHECKED, DO NOT GO BEYOND THIS LINE WITHOUT RECORDS SECTION BEING ADVISED, OR NO RECORD ENTRIES WILL BE MADE BELOW THIS LINE.

PROPERTY VALUE	26. PROPERTY	A. CURRENCY	B. JEWELRY	C. FURS CLOTHING	D. VEHICLE (LOCAL)	E. OFFICE EQUIPMENT	F. RADIO, TV CAMERAS	G. FIREARMS	H. HOUSE-HOLD GOODS
	STOLEN	\$	\$	\$	\$	\$	\$	\$	\$
	RECOVERED	\$	\$	\$	\$	\$	\$	\$	\$
	26. PROPERTY	I. CONSUMABLES	J. LIVESTOCK	K. DRUGS	L. MARINE ITEMS	M. CONSTRUCTION ITEMS	N. LAWN AND GARDEN	O. SPORTING GOODS	P. MISC BICYCLE
	STOLEN	\$	\$	\$	\$	\$	\$	\$	\$
	RECOVERED	\$	\$	\$	\$	\$	\$	\$	\$

27. PROPERTY RECOVERED: LOCALLY _____ OTHER JURISDICTION _____ (INSERT O OR L)

PROPERTY ITEMIZATION	PROPERTY STOLEN/RECOVERED ITEMIZATION, USE THE FOLLOWING FORMAT				32. CODE	
	28. QUANTITY	29. ARTICLE NAME	30. BRAND NAME	31. SERIAL NUMBER		
						S R <input type="checkbox"/> <input type="checkbox"/>
						S R <input type="checkbox"/> <input type="checkbox"/>
						S R <input type="checkbox"/> <input type="checkbox"/>
						S R <input type="checkbox"/> <input type="checkbox"/>

33. PROPERTY DAMAGE AMOUNT \$ _____ 34. INSURANCE COMPANY _____

35. OFFICER ASSAULTED Y N 36. ARSON Y N 37. STRUCTURE CODE _____ 38. DAMAGE \$ _____

47. CIB ENTERED CANCELLED
 NCIC
 OTHER BROADCAST

48. TOTAL AMOUNT PROPERTY STOLEN \$ _____

49. TOTAL AMOUNT PROPERTY RECOVERED \$ _____

50. IS REPORT CONTINUED? YES NO

51. CAUTION INDICATORS, ATLS ETC.

52. DATA PROCESS INFORMATION:

COMPUTER ENTERED DATE 5.8.99
 MICROFILM INDEXED INITIAL AS

53. FILE APPROVAL

IS CASE CLASSIFICATION CORRECT? Y N
 IF N HAS CORRECTION BEEN MADE? Y N

BY [Signature] DATE 03/10/99

1. CASE # **S99 No 01847** | 2. CLASSIFICATION **6.310.1.1** | 3. CENSUS **5.310.0.0**

4. INCIDENT **CS/S99-00242**

5. INCIDENT LOCATION **McDonald's - TR**

6. NAME - LAST - FIRST - MI **ANONY.** | 7. D.O.B.

8. ADDRESS | 9. TX-HOME

11. CITY STATE ZIP | 10. TX-BUSINESS

12. DETAILS **See Attached.**

1741
 030399

**MANITOWOC COUNTY SHERIFF
INCIDENT CARD**

18. ASSIGNED **M2750 929**
LT Bushman H.H.

19. REC. BY **938** | 20. DIS. BY | 22. TYPE OF REPORT
 INCIDENT
 ACCIDENT
 CITATION
 NONE

21. HOW REC'D.
 1. 911
 2. POLICE RADIO
 3. PHONE
 4. TTY
 5. IN PERSON
 6. ON VIEW
 7. OFF. OFF DUTY
 8. C.B. RADIO
 9. OTHER

23. STATUS
 1. UNFOUNDED
 2. PNL
 3. OTHER
 4. CLEARED
 5. EXCEPT CLEARED

24. DATE CLEARED **030899**
 25. OFFENSE TYPE
 1. ADULT NA
 2. JUVENILE
 3. UNKNOWN

14. REC'D | 15. DISP | 16. 10-23 | 17. 10-24
 13. DAY
 SUN 1 | **THU 5**
 MON 2 | FRI 6
 TUE 3 | SAT 7
 WED 4

39. (CODE S-SUSPECT W-WITNESS V-VICTIM O-OTHER)				42. ADDRESS		43. TELEPHONE
CODE	40. NAME-LAST	FIRST	MI	41. D.O.B.		

03/05/99 1451hrs Attempted contact with Complainant, not at home. Description does not match from 10-28, it appears there may be a number or letter of **CS**
 Contact made by phone with complainant who works at McDonald's in Two Rivers. The registration should be M2750T which comes back to owner above. The vehicle is a 91 Chev. S-10 2dr blazer, does not match vehicle we're looking for. Close Out **M.J. Bushman**

1/37

45. IF COMPLAINANT DIFFERENT THEN CALLER, ENTER NAME, ADDRESS, D.O.B., TELEPHONE.

46. IF CODE O (OTHER) IS USED IN FIELD #39, EXPLAIN.

INCIDENT REPORT: NOTE: IF SECTION 22 ABOVE HAS NUMBER 4 CHECKED, DO NOT GO BEYOND THIS LINE WITHOUT RECORDS SECTION BEING ADVISED, OR NO RECORD ENTRIES WILL BE MADE BELOW THIS LINE.

PROPERTY VALUE	26. PROPERTY	A. CURRENCY	B. JEWELRY	C. FURS CLOTHING	D. VEHICLE (LOCAL)	E. OFFICE EQUIPMENT	F. RADIO, TV CAMERAS	G. FIREARMS	H. HOUSE-HOLD GOODS
	STOLEN	\$	\$	\$	\$	\$	\$	\$	\$
	RECOVERED	\$	\$	\$	\$	\$	\$	\$	\$
	26. PROPERTY	I. CONSUMABLES	J. LIVESTOCK	K. DRUGS	L. MARINE ITEMS	M. CONSTRUCTION ITEMS	N. LAWN AND GARDEN	O. SPORTING GOODS	P. MISC BICYCLE
	STOLEN	\$	\$	\$	\$	\$	\$	\$	\$
	RECOVERED	\$	\$	\$	\$	\$	\$	\$	\$

27. PROPERTY RECOVERED: LOCALLY _____ OTHER JURISDICTION _____ (INSERT O OR L)

PROPERTY ITEMIZATION	PROPERTY STOLEN/RECOVERED ITEMIZATION, USE THE FOLLOWING FORMAT				
	28. QUANTITY	29. ARTICLE NAME	30. BRAND NAME	31. SERIAL NUMBER	
					S <input type="checkbox"/> R <input type="checkbox"/>
					S <input type="checkbox"/> R <input type="checkbox"/>
					S <input type="checkbox"/> R <input type="checkbox"/>
					S <input type="checkbox"/> R <input type="checkbox"/>

33. PROPERTY DAMAGE AMOUNT \$ _____ 34. INSURANCE COMPANY _____

35. OFFICER ASSAULTED Y N 36. ARSON Y N 37. STRUCTURE CODE _____ 38. DAMAGE \$ _____

47. CIB <input type="checkbox"/>	ENTERED <input type="checkbox"/>	CANCELLED <input type="checkbox"/>	48. TOTAL AMOUNT PROPERTY STOLEN \$ _____
NCIC <input type="checkbox"/>	<input type="checkbox"/>	<input type="checkbox"/>	
OTHER BROADCAST <input type="checkbox"/>	<input type="checkbox"/>	<input type="checkbox"/>	
			49. TOTAL AMOUNT PROPERTY RECOVERED \$ _____

50. IS REPORT CONTINUED? YES NO

51. CAUTION INDICATORS, ATLS ETC.

52. DATA PROCESS INFORMATION:

COMPUTER ENTERED DATE 3/8/99

MICROFILM INDEXED INITIAL AS

IS CASE CLASSIFICATION CORRECT? N

IF N HAS CORRECTION BEEN MADE? N

53. FILE APPROVAL

BY  DATE 3/8/99

MANITOWOC COUNTY SHERIFF
INCIDENT CARD

1. CASE # S99 No. 01873
 2. CLASSIFICATION 631011
 3. CENSUS 521000
 4. INCIDENT 05 / S99-00242
 5. INCIDENT LOCATION Hwy 157 + I43
 6. NAME - LAST-FIRST-MI Anonimus
 7. D.O.B.
 8. ADDRESS
 9. TX-HOME
 10. TX-BUSINESS
 11. CITY STATE ZIP
 12. DETAILS See Attached

03/05/99
 PUP 1 PUP

18. ASSIGNED M50 929
 19. REC. BY 435
 20. DIS. BY
 21. HOW REC'D.
 1. 911
 2. POLICE RADIO
 3. PHONE
 4. TTY
 5. IN PERSON
 6. ON VIEW
 7. OFF. OFF DUTY
 8. C.B. RADIO
 9. OTHER
 21A. M.O.
 22. TYPE OF REPORT
 1. INCIDENT
 2. ACCIDENT
 3. CITATION
 4. NONE
 23. STATUS
 1. UNFOUNDED
 2. PNL
 3. OTHER
 4. CLEARED
 5. EXCEPT CLEARED
 24. DATE CLEARED 03/08/99
 25. OFFENSE TYPE
 1. ADULT NA
 2. JUVENILE
 3. UNKNOWN

39. (CODE S-SUSPECT W-WITNESS V-VICTIM O-OTHER) CODE	40. NAME-LAST FIRST MI	41. D.O.B.	42. ADDRESS	43. TELEPHONE
O	First and Portland Corp. 176295		PO Box [redacted] Fond Du Lac	[redacted]
O	Hughes, Leonard H. 176296	[redacted]	[redacted] So. Park St., Fond Du Lac	Same

03/06/99 1030hrs Contact by phone made with Complainant who stated he only got a glimpse of the vehicle as it went by and noted Rt. Front fender damage. He did not get a good look at the grille and headlamp but stated there had to be damage there too. He thought but was not sure this would be the newer style pickup.

1045hrs Contact made with Leonard Hughes part owner of First and Portland Corp. in Fond Du Lac. He stated that truck was in Manitowoc and does have Rt. Front damage. It is the newer style truck and was damaged at their South Street Warehouse when a part time High School employee without a drivers license ran into a concrete embankment. IT was on private property no accident report completed, but I should feel free to check with the Fond Du Lac Police if I need varification and I could call the Part Time employee if I wished to talk with him. This is not out suspect vehicle, Close out. M.J. Bushman

S99 No. 01873

45. IF COMPLAINANT DIFFERENT THEN CALLER, ENTER NAME, ADDRESS, D.O.B., TELEPHONE.

46. IF CODE O (OTHER) IS USED IN FIELD #39, EXPLAIN.

INCIDENT REPORT: NOTE: IF SECTION 22 ABOVE HAS NUMBER 4 CHECKED, DO NOT GO BEYOND THIS LINE WITHOUT RECORDS SECTION BEING ADVISED, OR NO RECORD ENTRIES WILL BE MADE BELOW THIS LINE.

PROPERTY VALUE	26. PROPERTY	A. CURRENCY	B. JEWELRY	C. FURS CLOTHING	D. VEHICLE (LOCAL)	E. OFFICE EQUIPMENT	F. RADIO, TV CAMERAS	G. FIREARMS	H. HOUSE-HOLD GOODS
	STOLEN	\$	\$	\$	\$	\$	\$	\$	\$
	RECOVERED	\$	\$	\$	\$	\$	\$	\$	\$
	26. PROPERTY	I. CONSUMABLES	J. LIVESTOCK	K. DRUGS	L. MARINE ITEMS	M. CONSTRUCTION ITEMS	N. LAWN AND GARDEN	O. SPORTING GOODS	P. MISC BICYCLE
STOLEN	\$	\$	\$	\$	\$	\$	\$	\$	
RECOVERED	\$	\$	\$	\$	\$	\$	\$	\$	

27. PROPERTY RECOVERED: LOCALLY _____ OTHER JURISDICTION _____ (INSERT O OR L)

PROPERTY ITEMIZATION	PROPERTY STOLEN/RECOVERED ITEMIZATION, USE THE FOLLOWING FORMAT				
	28. QUANTITY	29. ARTICLE NAME	30. BRAND NAME	31. SERIAL NUMBER	
					S R <input type="checkbox"/> <input type="checkbox"/>
					S R <input type="checkbox"/> <input type="checkbox"/>
					S R <input type="checkbox"/> <input type="checkbox"/>
					S R <input type="checkbox"/> <input type="checkbox"/>

33. PROPERTY DAMAGE AMOUNT \$ _____ 34. INSURANCE COMPANY _____

35. OFFICER ASSAULTED Y N 36. ARSON Y N 37. STRUCTURE CODE _____ 38. DAMAGE \$ _____

47. CIB ENTERED CANCELLED
 NCIC
 OTHER BROADCAST

48. TOTAL AMOUNT PROPERTY STOLEN \$ _____

49. TOTAL AMOUNT PROPERTY RECOVERED \$ _____

50. IS REPORT CONTINUED? YES NO

51. CAUTION INDICATORS, ATLS ETC.

52. DATA PROCESS INFORMATION:

COMPUTER ENTERED DATE 3.8.99
 MICROFILM INDEXED INITIAL KS

53. FILE APPROVAL

IS CASE CLASSIFICATION CORRECT? Y N
 IF N HAS CORRECTION BEEN MADE? Y N

BY [Signature] DATE 3.8.99

NEW STYLE

30 ST. WARE HOUSE ACC.

LEONARD HUGHES
H. HUGHES
[REDACTED] 30 PARK ST. [REDACTED]

1. CASE # S99 No 01889 2. CLASSIFICATION 6310.11 3. CENSUS 1,4,002

4. INCIDENT # 599-00242
 5. INCIDENT LOCATION GASS LK RD + CLOVER RD
 6. NAME - LAST - FIRST - MI ANONYMOUS (5)
 7. D.O.B.
 8. ADDRESS
 9. TX-HOME
 10. TX-BUSINESS
 11. CITY STATE ZIP

12. DETAILS
 COMP. BELIEVES IT TO BE VEH.
 AT ABOVE LOCATION, DRIVEN BY
 KEVIN ZARNIK WHO IS A JUNIOR
 OR SENIOR IN HIGH SCHOOL.
 SEE ATTACHED.

0830
03-06-99

14. REC'D.	15. DISP	16. 10-23	17. 10-24
13. DAY			
SUN 1	THU 5		
MON 2	FRI 6		
TUE 3	SAT 7		
WED 4			

MANITOWOC COUNTY SHERIFF
INCIDENT CARD

18. ASSIGNED INFO 9811
929
441

19. REC. BY 946 20. DIS. BY -

21. HOW REC'D.
 1. 911
 2. POLICE RADIO
 3. PHONE
 4. TTY
 5. IN PERSON
 6. ON VIEW
 7. OFF. OFF DUTY
 8. C.B. RADIO
 9. OTHER

22. TYPE OF REPORT
 1. INCIDENT
 2. ACCIDENT
 3. CITATION
 4. NONE

23. STATUS
 1. UNFOUNDED
 2. PNL
 3. OTHER
 4. CLEARED
 5. EXCEPT CLEARED

24. DATE CLEARED 03/08/99

25. OFFENSE TYPE
 1. ADULT NA
 2. JUVENILE
 3. UNKNOWN

21A. M.O.

39. (CODE S-SUSPECT W-WITNESS V-VICTIM O-OTHER)				42. ADDRESS		43. TELEPHONE
CODE	40. NAME-LAST	FIRST	MI	41. D.O.B.		
0	Ziarnik Kevin J.				Clover Rd. Mtwc	

03/06/99 0915hrs Kevin Ziarnik's truck is a high mounted large tires black Blazer which was broke down several days prior to the accident and spent the weekend out of service in the All Car parking lot waiting for the owner to decide who should repair it. It then was taken to Jim's Service sometime during the week after January 11th. I spoke with the service manager at All Car who varified the information which was given to me by Kenneth Ziarnik (Kevin's father). I am unsure if an incident report was started at that time as it was very early in the investigation, no Crime Stopper's reports had been started.
 Close Out. M.J. Bushman

001



45. IF COMPLAINANT DIFFERENT THEN CALLER, ENTER NAME, ADDRESS, D.O.B., TELEPHONE.

46. IF CODE O (OTHER) IS USED IN FIELD #39, EXPLAIN.

INCIDENT REPORT: NOTE: IF SECTION 22 ABOVE HAS NUMBER 4 CHECKED, DO NOT GO BEYOND THIS LINE WITHOUT RECORDS SECTION BEING ADVISED, OR NO RECORD ENTRIES WILL BE MADE BELOW THIS LINE.

PROPERTY VALUE	26. PROPERTY	A. CURRENCY	B. JEWELRY	C. FURS CLOTHING	D. VEHICLE (LOCAL)	E. OFFICE EQUIPMENT	F. RADIO, TV CAMERAS	G. FIREARMS	H. HOUSE-HOLD GOODS
	STOLEN	\$	\$	\$	\$	\$	\$	\$	\$
	RECOVERED	\$	\$	\$	\$	\$	\$	\$	\$
	26. PROPERTY	I. CONSUMABLES	J. LIVESTOCK	K. DRUGS	L. MARINE ITEMS	M. CONSTRUCTION ITEMS	N. LAWN AND GARDEN	O. SPORTING GOODS	P. MISC BICYCLE
	STOLEN	\$	\$	\$	\$	\$	\$	\$	\$
	RECOVERED	\$	\$	\$	\$	\$	\$	\$	\$

27. PROPERTY RECOVERED: LOCALLY ____ OTHER JURISDICTION ____ (INSERT O OR L)

PROPERTY ITEMIZATION	PROPERTY STOLEN/RECOVERED ITEMIZATION, USE THE FOLLOWING FORMAT			
	28. QUANTITY	29. ARTICLE NAME	30. BRAND NAME	31. SERIAL NUMBER

33. PROPERTY DAMAGE AMOUNT \$ _____ 34. INSURANCE COMPANY _____

35. OFFICER ASSAULTED Y N 36. ARSON Y N 37. STRUCTURE CODE _____ 38. DAMAGE \$ _____

47. CIB	ENTERED <input type="checkbox"/>	CANCELLED <input type="checkbox"/>	48. TOTAL AMOUNT PROPERTY STOLEN \$ _____
NCIC	<input type="checkbox"/>	<input type="checkbox"/>	
OTHER BROADCAST	<input type="checkbox"/>	<input type="checkbox"/>	
			49. TOTAL AMOUNT PROPERTY RECOVERED \$ _____

50. IS REPORT CONTINUED? YES NO 51. CAUTION INDICATORS, ATLS ETC.

52. DATA PROCESS INFORMATION:

COMPUTER ENTERED DATE 3/8/99

MICROFILM INDEXED INITIAL RS

IS CASE CLASSIFICATION CORRECT? Y N
IF N HAS CORRECTION BEEN MADE? Y N

53. FILE APPROVAL
BY [Signature] DATE 3/8/99

1. CASE # S99 No 01890 2. CLASSIFICATION 6310.11 3. CENSUS 521900

INCIDENT CS | S99-00242

5. INCIDENT LOCATION [redacted] Knuell St.

6. NAME-LAST-FIRST-MI Anonymous 7. D.O.B.

8. ADDRESS 9. TX-HOME

11. CITY STATE ZIP 10. TX-BUSINESS

12. DETAILS
A pick-up truck (make and year unknown) was parked in garage at above location.

1211
03/06/99
14. REC'D 15. DISP 16. 10-23 17. 10-24
13. DAY
SUN 1 THU 5
MON 2 FRI 6
TUE 3 SAT 7
WED 4

MANITOWOC COUNTY SHERIFF
INCIDENT CARD

18. ASSIGNED MTSO, 9A9
D. HERN 456

19. REC. BY 925 20. DIS. BY

21. HOW REC'D.
1. 911
2. POLICE RADIO
3. PHONE
4. TTY
5. IN PERSON
6. ON VIEW
7. OFF. OFF DUTY
8. C.B. RADIO
9. OTHER

22. TYPE OF REPORT
1. INCIDENT
2. ACCIDENT
3. CITATION
4. NONE

23. STATUS
1. UNFOUNDED
2. PNL
3. OTHER
4. CLEARED
5. EXCEPT CLEARED

24. DATE CLEARED 03/16/99

25. OFFENSE TYPE
1. ADULT NA
2. JUVENILE
3. UNKNOWN

21A. M.O.

39. (CODE S-SUSPECT W-WITNESS V-VICTIM O-OTHER)				41. D.O.B.	42. ADDRESS	43. TELEPHONE
CODE	40. NAME-LAST	FIRST	MI			
0	Pollock	Ann	C.	[redacted]	[redacted] Knuell Str. Mtwc.	[redacted]

Last night a trailer left the area. The trailer was big enough to fit a vehicle inside. Unknown if the truck was inside it or if it remains in the garage, where it had been for about a week. Caller feels it is suspicious because trailer left the area when it was dark outside. SESE

1020 hrs. 3/7/99 @ Checked the given address and found that no address is present for [redacted]. Called to Complainant at [redacted] (room [redacted] and spoke with him./ He stated that then maybe the number was [redacted] Knuell str.
1108 hrs. on 3/7/99 @ officer met and checked the garage of Ann C. Pollock who resides at this address. She stated that her and her husband reside here but own two differnet vehicles from the one we are looking for. She allowed me to check the garage, no indications of damage. This CS can be closed out. LT TKO

S99 No 01890

45. IF COMPLAINANT DIFFERENT THEN CALLER, ENTER NAME, ADDRESS, D.O.B., TELEPHONE.

46. IF CODE O (OTHER) IS USED IN FIELD #39, EXPLAIN.

INCIDENT REPORT: NOTE: IF SECTION 22 ABOVE HAS NUMBER 4 CHECKED, DO NOT GO BEYOND THIS LINE WITHOUT RECORDS SECTION BEING ADVISED, OR NO RECORD ENTRIES WILL BE MADE BELOW THIS LINE.

PROPERTY VALUE	26. PROPERTY	A. CURRENCY	B. JEWELRY	C. FURS CLOTHING	D. VEHICLE (LOCAL)	E. OFFICE EQUIPMENT	F. RADIO, TV CAMERAS	G. FIREARMS	H. HOUSE-HOLD GOODS
	STOLEN	\$	\$	\$	\$	\$	\$	\$	\$
	RECOVERED	\$	\$	\$	\$	\$	\$	\$	\$
	26. PROPERTY	I. CONSUMABLES	J. LIVESTOCK	K. DRUGS	L. MARINE ITEMS	M. CONSTRUCTION ITEMS	N. LAWN AND GARDEN	O. SPORTING GOODS	P. MISC BICYCLE
	STOLEN	\$	\$	\$	\$	\$	\$	\$	\$
	RECOVERED	\$	\$	\$	\$	\$	\$	\$	\$

27. PROPERTY RECOVERED: LOCALLY ____ OTHER JURISDICTION ____ (INSERT O OR L)

PROPERTY ITEMIZATION	28. QUANTITY	29. ARTICLE NAME	30. BRAND NAME	31. SERIAL NUMBER	32. CODE
					S R <input type="checkbox"/> <input type="checkbox"/>
					S R <input type="checkbox"/> <input type="checkbox"/>
					S R <input type="checkbox"/> <input type="checkbox"/>
					S R <input type="checkbox"/> <input type="checkbox"/>
					S R <input type="checkbox"/> <input type="checkbox"/>
					S R <input type="checkbox"/> <input type="checkbox"/>

33. PROPERTY DAMAGE AMOUNT \$ _____ 34. INSURANCE COMPANY _____

35. OFFICER ASSAULTED Y N 36. ARSON Y N 37. STRUCTURE CODE _____ 38. DAMAGE \$ _____

47. CIB	ENTERED <input type="checkbox"/>	CANCELLED <input type="checkbox"/>	48. TOTAL AMOUNT PROPERTY STOLEN \$ _____
NCIC	<input type="checkbox"/>	<input type="checkbox"/>	
OTHER BROADCAST	<input type="checkbox"/>	<input type="checkbox"/>	49. TOTAL AMOUNT PROPERTY RECOVERED \$ _____

50. IS REPORT CONTINUED? YES NO 51. CAUTION INDICATORS, ATLS ETC.

52. DATA PROCESS INFORMATION:

COMPUTER ENTERED DATE 13/16/99

MICROFILM INDEXED INITIAL KS

IS CASE CLASSIFICATION CORRECT? IF N HAS CORRECTION BEEN MADE? (Y) N N

53. FILE APPROVAL

BY [Signature] DATE 03/16/99

1. CASE # **S99 No 01905** | 2. CLASSIFICATION **6,3|0,1** | 3. CENSUS **1,4|0,1**

**MANITOWOC COUNTY SHERIFF
INCIDENT CARD**

4. INCIDENT **CS/ S99-00242**

18. ASSIGNED **Bushman** **4/11/99**

5. INCIDENT LOCATION

6. NAME - LAST - FIRST - MI **ANon** | 7. D.O.B.

8. ADDRESS | 9. TX-HOME

11. CITY | STATE | ZIP | 10. TX-BUSINESS

19. REC. BY **926** | 20. DIS. BY | 22. TYPE OF REPORT
 1. INCIDENT
 2. ACCIDENT
 3. CITATION
 4. NONE

12. DETAILS
Caller states there is a marroon or red

colored mini van with its grill out. It

is parked at N6th and Oak St in Mtwc at this

time. MTPD went to that location to view

the veh and get an RP KLB620

14. REC'D | 15. DISP | 16. 10-23 | 17. 10-24
15:48 3799
15:45
15:51
15:53
SUN 1 THU 5
MON 2 FRI 6
TUE 3 SAT 7
WED 4

21. HOW REC'D.
 1. 911
 2. POLICE RADIO
 3. PHONE
 4. TTY
 5. IN PERSON
 6. ON VIEW
 7. OFF. OFF DUTY
 8. C.B. RADIO
 9. OTHER

23. STATUS
 1. UNFOUNDED
 2. PNL
 3. OTHER
 4. CLEARED
 5. EXCEPT CLEARED

24. DATE CLEARED **103/16/99**
 25. OFFENSE TYPE
 1. ADULT NA
 2. JUVENILE
 3. UNKNOWN

39. (CODE S-SUSPECT W-WITNESS V-VICTIM O-OTHER)						
CODE	40. NAME-LAST	FIRST	MI	41. D.O.B.	42. ADDRESS	43. TELEPHONE
0	REICHMALT	PAUL	R.		ELIZABETH ST, MANITOWOC	

030799 1551 hrs officer THOMM from MTPD checked the vehicle in question. It did have extensive grill damage, but does not fit the suspect vehicle description. This mini van is 87 Plymouth. Officer THOMM did not feel any further follow up was needed on this vehicle. Report forwarded to LT. BUSHMAN for his review. as/926

*CLASIFIED
MTPD*

45. IF COMPLAINANT DIFFERENT THEN CALLER, ENTER NAME, ADDRESS, D.O.B., TELEPHONE.

46. IF CODE O (OTHER) IS USED IN FIELD #39, EXPLAIN.

INCIDENT REPORT: NOTE: IF SECTION 22 ABOVE HAS NUMBER 4 CHECKED, DO NOT GO BEYOND THIS LINE WITHOUT RECORDS SECTION BEING ADVISED, OR NO RECORD ENTRIES WILL BE MADE BELOW THIS LINE.

PROPERTY VALUE	26. PROPERTY	A. CURRENCY	B. JEWELRY	C. FURS CLOTHING	D. VEHICLE (LOCAL)	E. OFFICE EQUIPMENT	F. RADIO, TV CAMERAS	G. FIREARMS	H. HOUSE-HOLD GOODS
	STOLEN	\$	\$	\$	\$	\$	\$	\$	\$
	RECOVERED	\$	\$	\$	\$	\$	\$	\$	\$
	26. PROPERTY	I. CONSUM-ABLES	J. LIVESTOCK	K. DRUGS	L. MARINE ITEMS	M. CONSTRUCTION ITEMS	N. LAWN AND GARDEN	O. SPORTING GOODS	P. MISC BICYCLE
STOLEN	\$	\$	\$	\$	\$	\$	\$	\$	
RECOVERED	\$	\$	\$	\$	\$	\$	\$	\$	

27. PROPERTY RECOVERED: LOCALLY _____ OTHER JURISDICTION _____ (INSERT O OR L)

PROPERTY ITEMIZATION	PROPERTY STOLEN/RECOVERED ITEMIZATION, USE THE FOLLOWING FORMAT				
	28. QUANTITY	29. ARTICLE NAME	30. BRAND NAME	31. SERIAL NUMBER	32. CODE
					S R <input type="checkbox"/> <input type="checkbox"/>
					S R <input type="checkbox"/> <input type="checkbox"/>
					S R <input type="checkbox"/> <input type="checkbox"/>
					S R <input type="checkbox"/> <input type="checkbox"/>
					S R <input type="checkbox"/> <input type="checkbox"/>

33. PROPERTY DAMAGE AMOUNT \$ _____

34. INSURANCE COMPANY _____

35. OFFICER ASSAULTED Y N

36. ARSON Y N

37. STRUCTURE CODE _____

38. DAMAGE \$ _____

47. CIB ENTERED CANCELLED
 NCIC
 OTHER BROADCAST

48. TOTAL AMOUNT PROPERTY STOLEN \$ _____

49. TOTAL AMOUNT PROPERTY RECOVERED \$ _____

50. IS REPORT CONTINUED? YES NO

51. CAUTION INDICATORS, ATLS ETC.

52. DATA PROCESS INFORMATION:

COMPUTER ENTERED DATE 3/16/99

MICROFILM INDEXED INITIAL KS

IS CASE CLASSIFICATION CORRECT? Y N
 IF N HAS CORRECTION BEEN MADE? Y N

53. FILE APPROVAL

BY R

DATE 03/16/99

1. CASE # S99 No. 01955 | 2. CLASSIFICATION 6310.11 | 3. CENSUS 7,010,00

4. INCIDENT CS / S99-00242

5. INCIDENT LOCATION SBD - DMV

6. NAME - LAST-FIRST-MI ANONY. | 7. D.O.B.

8. ADDRESS | 9. TX-HOME

11. CITY STATE ZIP | 10. TX-BUSINESS

12. DETAILS See Attached

1730
03-09-99

14. REC'D	15. DISP	16. 10-23	17. 10-24
13. DAY			
SUN 1	THU 5		
MON 2	FRI 6		
TUE 3	SAT 7		
WED 4			

MANITOWOC COUNTY SHERIFF
INCIDENT CARD

18. ASSIGNED
9219
Bushman H.H.H.

19. REC. BY 938 | 20. DIS. BY

22. TYPE OF REPORT
① INCIDENT
② ACCIDENT
③ CITATION
④ NONE

21. HOW REC'D.
① 911
② POLICE RADIO
③ PHONE
④ TTY
⑤ IN PERSON
⑥ ON VIEW
⑦ OFF. OFF DUTY
⑧ C.B. RADIO
⑨ OTHER

23. STATUS
① UNFOUNDED
② PNL
③ OTHER
④ CLEARED
⑤ EXCEPT CLEARED

24. DATE CLEARED 03/16/99

25. OFFENSE TYPE
1. ADULT NA
2. JUVENILE
3. UNKNOWN

21A.M.O.

39. (CODE S-SUSPECT W-WITNESS V-VICTIM O-OTHER)				41. D.O.B.	42. ADDRESS	43. TELEPHONE
CODE	40.NAME-LAST	FIRST	MI			

03/09/99 1730hrs TTY sent to Sheboygan PD and request made to assist. 2nd TTY sent two hours later when there was no response. No response.
03/11/99 1400hrs Call made to Shift Commander and he was unaware if vehicle was ever located as it was not located when first attempted.
Close pending more information M.J. Bushman

MJB

45. IF COMPLAINANT DIFFERENT THEN CALLER, ENTER NAME, ADDRESS, D.O.B., TELEPHONE.

46. IF CODE O (OTHER) IS USED IN FIELD #39, EXPLAIN.

INCIDENT REPORT: NOTE: IF SECTION 22 ABOVE HAS NUMBER 4 CHECKED, DO NOT GO BEYOND THIS LINE WITHOUT RECORDS SECTION BEING ADVISED, OR NO RECORD ENTRIES WILL BE MADE BELOW THIS LINE.

PROPERTY VALUE	26. PROPERTY	A. CURRENCY	B. JEWELRY	C. FURS CLOTHING	D. VEHICLE (LOCAL)	E. OFFICE EQUIPMENT	F. RADIO, TV CAMERAS	G. FIREARMS	H. HOUSE-HOLD GOODS
	STOLEN	\$	\$	\$	\$	\$	\$	\$	\$
	RECOVERED	\$	\$	\$	\$	\$	\$	\$	\$
	26. PROPERTY	I. CONSUMABLES	J. LIVESTOCK	K. DRUGS	L. MARINE ITEMS	M. CONSTRUCTION ITEMS	N. LAWN AND GARDEN	O. SPORTING GOODS	P. MISC BICYCLE
	STOLEN	\$	\$	\$	\$	\$	\$	\$	\$
	RECOVERED	\$	\$	\$	\$	\$	\$	\$	\$

27. PROPERTY RECOVERED: LOCALLY ____ OTHER JURISDICTION ____ (INSERT O OR L)

PROPERTY ITEMIZATION	PROPERTY STOLEN/RECOVERED ITEMIZATION, USE THE FOLLOWING FORMAT				
	28. QUANTITY	29. ARTICLE NAME	30. BRAND NAME	31. SERIAL NUMBER	32. CODE
					S R <input type="checkbox"/> <input type="checkbox"/>
					S R <input type="checkbox"/> <input type="checkbox"/>
					S R <input type="checkbox"/> <input type="checkbox"/>
					S R <input type="checkbox"/> <input type="checkbox"/>

33. PROPERTY DAMAGE AMOUNT \$ _____ 34. INSURANCE COMPANY _____

35. OFFICER ASSAULTED Y N 36. ARSON Y N 37. STRUCTURE CODE _____ 38. DAMAGE \$ _____

47. CIB	ENTERED	CANCELLED	48. TOTAL AMOUNT PROPERTY STOLEN \$ _____
	<input type="checkbox"/>	<input type="checkbox"/>	
	NCIC	<input type="checkbox"/>	
OTHER BROADCAST	<input type="checkbox"/>	<input type="checkbox"/>	49. TOTAL AMOUNT PROPERTY RECOVERED \$ _____

50. IS REPORT CONTINUED? YES NO 51. CAUTION INDICATORS, ATLS ETC.

52. DATA PROCESS INFORMATION:

COMPUTER ENTERED DATE 3/16/99

MICROFILM INDEXED INITIAL AS

IS CASE CLASSIFICATION CORRECT? Y N

IF N HAS CORRECTION BEEN MADE? Y N

53. FILE APPROVAL

BY [Signature] DATE 3/16/99

1. CASE # **S99 No 01959** | 2. CLASSIFICATION **6301** | 3. CENSUS **70000**

4. INCIDENT **CS/S99-00242**

5. INCIDENT LOCATION **CTH CR**

6. NAME- LAST-FIRST-MI **ANONYMOUS** | 7. D.O.B

8. ADDRESS | 9. TX-HOME

11. CITY | STATE | ZIP | 10. TX-BUSINESS

12. DETAILS
**CALLER'S FRIEND RECENTLY PURCHASED
 A GREEN/WHITE GMC VAN (POSS 1979)
 FOR "JUNK PRICE" WHICH HAS DAMAGE
 TO GRILL & BUMPER ON PASS. SIDE.**

2033
3-9-99

**MANITOWOC COUNTY SHERIFF
INCIDENT CARD**

18. ASSIGNED **MTSO** | **9/2/99**
4/4/11

19. REC. BY **932** | 20. DIS. BY
 21. HOW REC'D.
 1. 911
 2. POLICE RADIO
 3. PHONE
 4. TTY
 5. IN PERSON
 6. ON VIEW
 7. OFF. OFF DUTY
 8. C.B. RADIO
 9. OTHER
 21A.M.O.
 22. TYPE OF REPORT
 1. INCIDENT
 2. ACCIDENT
 3. CITATION
 4. NONE
 23. STATUS
 1. UNFOUNDED
 2. PNL
 3. OTHER
 4. CLEARED
 5. EXCEPT CLEARED
 24. DATE CLEARED **03/16/99**
 25. OFFENSE TYPE
 1. ADULT NA
 2. JUVENILE
 3. UNKNOWN

14. REC'D | 15. DISP | 16. 10-23 | 17. 10-24
 13. DAY
 SUN 1 THU 5
 MON 2 FRI 6
 TU 3 SAT 7
 WED 4

39. (CODE S-SUSPECT W-WITNESS V-VICTIM O-OTHER)						
CODE	40. NAME-LAST	FIRST	MI	41. D.O.B.	42. ADDRESS	43. TELEPHONE
0	[REDACTED]			[REDACTED]	[REDACTED]	
0	Knapp, Kenneth D.			[REDACTED]	[REDACTED] 19th St, Two Rivers	[REDACTED]

03/11/99 1432hrs Contact made by phone with Kewaunee Co. SO and request made to assist by making contact. Crime Stoppers work sheet faxed after name of complainant was blacked out as he wished to remain anonymous. M.J. Bushman

03/13/99 Off. Kuehl Kewaunee Co. SO located the vehicle in question at [REDACTED] Townline Rd now owned by [REDACTED] who purchased it from Kenneth D. Knapp Two Rivers, in late February early March, just to be used for parts. At the time the Crime Stoppers complaint came in it was not known the seller was Kenneth Knapp. That van was checked by joint effort with myself and Two Rivers PD in Crimestoppers complaint # S99-01202. Close out. M.J. Bushman

PP 218

17

S99 No 01959

45. IF COMPLAINANT DIFFERENT THEN CALLER, ENTER NAME, ADDRESS, D.O.B., TELEPHONE.

46. IF CODE O (OTHER) IS USED IN FIELD #39, EXPLAIN.

INCIDENT REPORT: NOTE: IF SECTION 22 ABOVE HAS NUMBER 4 CHECKED, DO NOT GO BEYOND THIS LINE WITHOUT RECORDS SECTION BEING ADVISED, OR NO RECORD ENTRIES WILL BE MADE BELOW THIS LINE.

PROPERTY VALUE	26. PROPERTY	A. CURRENCY	B. JEWELRY	C. FURS CLOTHING	D. VEHICLE (LOCAL)	E. OFFICE EQUIPMENT	F. RADIO, TV CAMERAS	G. FIREARMS	H. HOUSE-HOLD GOODS
	STOLEN	\$	\$	\$	\$	\$	\$	\$	\$
	RECOVERED	\$	\$	\$	\$	\$	\$	\$	\$
	26. PROPERTY	I. CONSUMABLES	J. LIVESTOCK	K. DRUGS	L. MARINE ITEMS	M. CONSTRUCTION ITEMS	N. LAWN AND GARDEN	O. SPORTING GOODS	P. MISC BICYCLE
	STOLEN	\$	\$	\$	\$	\$	\$	\$	\$
	RECOVERED	\$	\$	\$	\$	\$	\$	\$	\$

27. PROPERTY RECOVERED: LOCALLY _____ OTHER JURISDICTION _____ (INSERT O OR L)

PROPERTY ITEMIZATION	PROPERTY STOLEN/RECOVERED ITEMIZATION, USE THE FOLLOWING FORMAT				31. SERIAL NUMBER	32. CODE	
	28. QUANTITY	29. ARTICLE NAME	30. BRAND NAME			S	R
						<input type="checkbox"/>	<input type="checkbox"/>
						<input type="checkbox"/>	<input type="checkbox"/>
						<input type="checkbox"/>	<input type="checkbox"/>
						<input type="checkbox"/>	<input type="checkbox"/>
						<input type="checkbox"/>	<input type="checkbox"/>
						<input type="checkbox"/>	<input type="checkbox"/>

33. PROPERTY DAMAGE AMOUNT \$ _____ 34. INSURANCE COMPANY _____

35. OFFICER ASSAULTED Y N 36. ARSON Y N 37. STRUCTURE CODE _____ 38. DAMAGE \$ _____

47. CIB ENTERED CANCELLED
 NCIC
 OTHER BROADCAST

48. TOTAL AMOUNT PROPERTY STOLEN \$ _____

49. TOTAL AMOUNT PROPERTY RECOVERED \$ _____

50. IS REPORT CONTINUED? YES NO

51. CAUTION INDICATORS, ATLS ETC.

52. DATA PROCESS INFORMATION:
 COMPUTER ENTERED DATE 3/16/99
 MICROFILM INDEXED INITIAL AS
 IS CASE CLASSIFICATION CORRECT? N
 IF N HAS CORRECTION BEEN MADE? N

53. FILE APPROVAL
 BY [Signature] DATE 3/16/99

Manitowoc County Sheriff's Department

Thomas H. Kocourek
SHERIFF

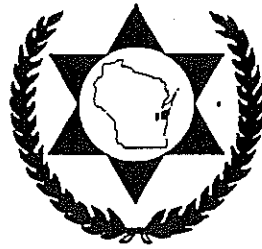

Kenneth J. Petersen
INSPECTOR

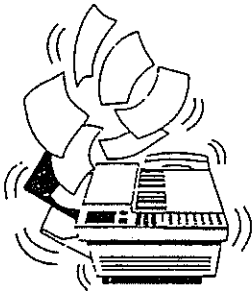

FAX

DATE 03/11/99

TO: KWSO

FAX #: [REDACTED]

FROM: LT. BUSHMAN - MISO

NUMBER OF PAGES SENT INCLUDING THIS ONE 2

CONFIDENTIALITY NOTICE

This message is intended only for the use of the individual or entity to which it is addressed and may contain information that is privileged, confidential, and exempt from disclosure under applicable law. If the reader of this message is not the intended recipient or the employee or agent responsible for delivering the message to the intended recipient, you are hereby notified that any dissemination, distribution, or copying of this communication is strictly prohibited. If you have received this communication in error, please notify us immediately by telephone and return the original message to us at the above address via the U.S. Postal Service. Thank you.

SHERIFF'S DEPT FAX NUMBERS: [REDACTED] - Detectives [REDACTED] - Dispatch [REDACTED] - Jail [REDACTED] - Juvenile

[redacted] Townline Rd
Newman, CA 94546
[redacted]
[redacted] # [redacted]

Kenneth D. Knapp
[redacted]

[redacted] purchased
from Knapp - late
Feb. or early March.
for parts

1. CASE # **S99 No 01965** 2. CLASSIFICATION **6310.11** 3. CENSUS **52P,0,0**

4. INCIDENT **C5/S99-00242**

5. INCIDENT LOCATION **S. 23RD ST, MTWC # 1060.**

6. NAME LAST-FIRST-MI **ANONYMOUS** 7. D.O.B.

8. ADDRESS 9. TX-HOME

11. CITY STATE ZIP 10. TX-BUSINESS

12. DETAILS
**SAW BLAZER-TYPE VEH 2 WKS
 AGO PARKED IN UNIVERSITY
 VILLAGE HTS THAT COULD BE
 SUSPECT.**

2148.

14. REC'D	15. DISP	16. 10-23	17. 10-24
SUN 1	THU 5	MON 2	FRI 6
TUE 3	SAT 7	WED 4	

**MANITOWOC COUNTY SHERIFF
INCIDENT CARD**

18. ASSIGNED **MTSO** **91219**

19. REC. BY **932** 20. DIS. BY

21. HOW REC'D.
 1. 911
 2. POLICE RADIO
 3. PHONE
 4. TTY
 5. IN PERSON
 6. ON VIEW
 7. OFF. OFF DUTY
 8. C.B. RADIO
 9. OTHER

22. TYPE OF REPORT
 1. INCIDENT
 2. ACCIDENT
 3. CITATION
 4. NONE

23. STATUS
 1. UNFOUNDED
 2. PNL
 3. OTHER
 4. CLEARED
 5. EXCEPT CLEARED

24. DATE CLEARED **10/4/12/99**

25. OFFENSE TYPE
 1. ADULT NA
 2. JUVENILE
 3. UNKNOWN

39. (CODE S-SUSPECT W-WITNESS V-VICTIM O-OTHER)	40. NAME-LAST	FIRST	MI	41. D.O.B.	42. ADDRESS	43. TELEPHONE
O	BASTIAN	KRIS	J		S 23rd St # [redacted], Manitowoc	[redacted]
O	DECKER	THOMAS	J.		CTH K, WHITE LAW	[redacted]

03/13/99 1125hrs and 1304hrs Attempted contact at the trailer # [redacted], light on, no one car on the parking pad, no answer at door. M.J. Bushman

03/16/99 1610hrs no answer at door, no car on pad. M.J. Bushman

03/22/99 @ 2105hrs I attempted contact at trailer [redacted] No lights were on, no answer at the door and there was no veh at the residence. JJ Froelich

03/23/99 @ 0705 Hrs.: I, Deputy O'Connor, made contact with KRIS BASTIAN at his residence in the UNIVERSITY VILLAGE TRAILER PARK regarding this matter. There were no vehicles parked at the trailer. The only means of transportation was a multi-speed bicycle which was leaning on the side of the trailer.

When I made contact with BASTIAN, I explained the reason I was there. He stated he did not own any vehicles. He said the van which would have been parked at his trailer was owned by THOMAS DECKER. DECKER is an acquaintance of BASTIAN'S and does drive a Chevy van. BASTIAN also stated DECKER mentioned that he had been stopped twice in one day while driving his van so police could look at the front end of his van. After getting the information, I thanked BASTIAN for his cooperation in the matter.

About 1 hour after I left BASTIAN'S residence, I got a message from Dispatch to call BASTIAN back. He stated there was a red, full-sized van which was parked in front of his trailer on the roadway at times. He said the van is usually parked there in the morning hours. He said he believed the owner was a neighbor who lives 2 trailers from his. He said this may have also been the van that someone saw parked at his trailer.

I checked later in the morning. The van was parked in front of his trailer; however, it was a Dodge Ram van; therefore, it does not match the description of the suspect vehicle.
 POCConnor /bjc

03/23/99 There are 4 Thomas Decker's, no answer at Bastian residence to find out which one is his friend. There was no Decker vehicle recorded in FBI Database. M.J. Bushman

S99 No 01965

45. IF COMPLAINANT DIFFERENT THEN CALLER, ENTER NAME, ADDRESS, D.O.B., TELEPHONE.

46. IF CODE O (OTHER) IS USED IN FIELD #39, EXPLAIN.

INCIDENT REPORT: NOTE: IF SECTION 22 ABOVE HAS NUMBER 4 CHECKED, DO NOT GO BEYOND THIS LINE WITHOUT RECORDS SECTION BEING ADVISED, OR NO RECORD ENTRIES WILL BE MADE BELOW THIS LINE.

PROPERTY VALUE	26. PROPERTY	A. CURRENCY	B. JEWELRY	C. FURS CLOTHING	D. VEHICLE (LOCAL)	E. OFFICE EQUIPMENT	F. RADIO, TV CAMERAS	G. FIREARMS	H. HOUSE-HOLD GOODS
	STOLEN	\$	\$	\$	\$	\$	\$	\$	\$
	RECOVERED	\$	\$	\$	\$	\$	\$	\$	\$
	26. PROPERTY	I. CONSUM-ABLES	J. LIVESTOCK	K. DRUGS	L. MARINE ITEMS	M. CONSTRUCTION ITEMS	N. LAWN AND GARDEN	O. SPORTING GOODS	P. MISC BICYCLE
	STOLEN	\$	\$	\$	\$	\$	\$	\$	\$
	RECOVERED	\$	\$	\$	\$	\$	\$	\$	\$

27. PROPERTY RECOVERED: LOCALLY _____ OTHER JURISDICTION _____ (INSERT O OR L)

PROPERTY ITEMIZATION	PROPERTY STOLEN/RECOVERED ITEMIZATION, USE THE FOLLOWING FORMAT				
	28. QUANTITY	29. ARTICLE NAME	30. BRAND NAME	31. SERIAL NUMBER	
					S R <input type="checkbox"/> <input type="checkbox"/>
					S R <input type="checkbox"/> <input type="checkbox"/>
					S R <input type="checkbox"/> <input type="checkbox"/>
					S R <input type="checkbox"/> <input type="checkbox"/>

33. PROPERTY DAMAGE AMOUNT \$ _____ 34. INSURANCE COMPANY _____

35. OFFICER ASSAULTED Y N 36. ARSON Y N 37. STRUCTURE CODE _____ 38. DAMAGE \$ _____

47. CIB	ENTERED <input type="checkbox"/>	CANCELLED <input type="checkbox"/>	48. TOTAL AMOUNT PROPERTY STOLEN \$ _____
NCIC	<input type="checkbox"/>	<input type="checkbox"/>	49. TOTAL AMOUNT PROPERTY RECOVERED \$ _____
OTHER BROADCAST	<input type="checkbox"/>	<input type="checkbox"/>	

50. IS REPORT CONTINUED? YES NO 51. CAUTION INDICATORS, ATLS ETC.

52. DATA PROCESS INFORMATION:

COMPUTER ENTERED DATE 10/29/99

MICROFILM INDEXED INITIAL AS

IS CASE CLASSIFICATION CORRECT? Y N

IF N HAS CORRECTION BEEN MADE? Y N

53. FILE APPROVAL

BY [Signature] DATE 10/4/6/99

MANITOWOC COUNTY SHERIFF'S DEPARTMENT
FOLLOW-UP REPORT

Page: 2

CASE NUMBER: S99-01965 CLASSIFICATION: _____

INCIDENT: _____

DATE AND TIME: _____

REPORT CONTINUED:

03/30/99 Attempted contact with Bastian by stopping 1933hrs, no one home. Attempted contact by phone, no answer after three attempts until 2300hrs.

03/31/99 Left the phone ring longer and an answering machine picked up which did not happen before, message left.

1205hrs Bastian called back and informed me the Thomas Decker we are looking for is in the Whitelaw area. Attempt had been made there earlier in the evening by Off.Bessler, no van in plain view, lights all out.

1215hrs Received phone call from Thomas Decker, Bastian must have called him informing him I was looking for him. He stated he just got home from work, showered and told me he was told I wanted to talk to him. He does own an 85 Chev. van double headlamps each side. It has damage to the hood and roof caused by a tree falling on it with a previous owner. Decker stated he had owned the vehicle for two years. He stated he was in to see Sheriff Kocourek because he has been stopped three times. State Patrol on I-43, MISO and Mishicot with all officers checking the damage. Registration is SFZ106. Vehicle has been checked this complaint can be closed.M.J.Bushman

ENTERED ETC

3 TIMES STOPPED
 STATE COUNTY WISCONSIN
 SFZ 106
 85 CHEV. FELL ON IT
 2 YRS AGO

-ALPHA-

PERSON MASTER INQUIRY

LAST NAME: DECKER FIRST NAME: THOMAS DOB: 000000

PERSON	NAME		D.O.B.		
51420	DECKER	THOMAS	[REDACTED]	HAMILTON	
58427	DECKER	THOMAS	J [REDACTED]	A M MANITOWOC	WI
79708	DECKER	THOMAS	D [REDACTED]	A M WHITEHALL	WI
103182	DECKER	THOMAS	J [REDACTED]	A M COLUMBUS	OH
				A M GREEN BAY	WI

CRIMESTOPPER INTERVIEW FORM

DATE & TIME CALL RECEIVED 03-10-99 0850

CRIMESTOPPER INCIDENT NUMBER 599-00242

TYPE OF CRIME FATAL HIT AND RUN

DATE OF CRIME 01-10-99

LOCATION OF CRIME _____

SUSPECT INFORMATION:

NAME _____ ALIAS _____

DOB _____ AGE _____ SEX _____ RACE _____

HEIGHT _____ WEIGHT _____ HAIR _____ EYES _____

SCARS/TATTOOS _____

ARMED ? _____ TYPE OF WEAPON _____

AUTO: MAKE _____ YEAR _____ COLOR _____

BODY STYLE Suburban LICENSE # TBG6669 STATE NJ

DAMAGE OR ODDITIES grill and hood damage

INFORMATION: [REDACTED] SAW A SUBURBAN AT THE HAWKEYE BAR IN KK. IT HAD GRILL AND HOOD DAMAGE. HE SAID THERE WAS A DENT IN THE HOOD THAT LOOKED LIKE A HEAD HIT IT. IT WAS IN THE SHAPE OF A HEAD. HE GAVE A LICENSE # TBG6669. DID NOT WANT TO STAY ON PHONE, IT'S LONG DISTANCE AND HE IS NOT RICH. [REDACTED] CALLED THROUGH RELAY SERVICE FOR THE DEAF. THE PHONE NO. FOR HIM ARE TOO AND RELAY SERVICE.

CALLER INFORMATION: (OPTIONAL)

NAME [REDACTED] PHONE [REDACTED]

ADDRESS [REDACTED]

INTERESTED IN REWARD: YES NO

WISH TO REMAIN ANONYMOUS: YES NO

WILLING TO TALK TO AN OFFICER: YES NO

TIME & DATE WILLING TO TALK ANYTIME

DISPATCHER TAKING CALL: 946CK

Manitowoc County Sheriff's Department

Thomas H. Kocourek
SHERIFF



Kenneth J. Petersen
INSPECTOR

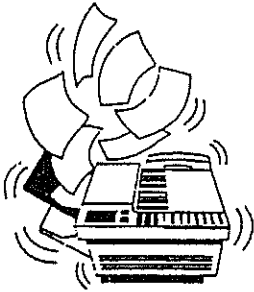

FAX

DATE 3-11-99

TO: Kaukauna PD

FAX #: _____

FROM: LT Bushman

NUMBER OF PAGES SENT INCLUDING THIS ONE 2

CONFIDENTIALITY NOTICE

This message is intended only for the use of the individual or entity to which it is addressed and may contain information that is privileged, confidential, and exempt from disclosure under applicable law. If the reader of this message is not the intended recipient or the employee or agent responsible for delivering the message to the intended recipient, you are hereby notified that any dissemination, distribution, or copying of this communication is strictly prohibited. If you have received this communication in error, please notify us immediately by telephone and return the original message to us at the above address via the U.S. Postal Service. Thank you.

SHERIFF'S DEPT FAX NUMBERS: [REDACTED]

[REDACTED] - Detectives [REDACTED] - Dispatch [REDACTED] - Jail [REDACTED] - Juvenile

FOX VALLEY METRO POLICE DEPARTMENT
OFFENSE REPORT

Incident Number 990029546

PART TWO --- OFFENSE INFORMATION

Incident Number 990029546 Date 03-11-99 Officer 613
Nature Agency Assist Location _____ City Little Chute
Arrived 1545 Cleared 1700 Offense Status _____ Cleared By _____
Disposition 04 ISC 9902 Report Code 01 Arrests 0
Date of Incident: From: _____ Time: _____ TO: _____ Time: _____
Assisting Officer(s) 630

PART THREE --- CONTACT INFORMATION

Contact NBR _____
Name/Business Verbeteren John R Telephone _____
Last First Middle
Address [REDACTED] N. Holland City Little Chute State WI Zip 54140
Work _____ Telephone _____
Sex M Race W Ethnic N Height 6'2 Weight 165 Hair Blond Eyes Blue
DOB [REDACTED] Scars/Marks _____ Actions _____ Injured _____
Juvenile Yes Contact Code SU Contact Disposition 04 Report Type 01 Charged 0
Suspect Status 04 Suspect Code 11 Warrant Filed _____ Rights Read _____
School N/A Grade _____ Parents _____
Fingerprint _____ Photograph _____ Note _____
Warning Information _____

INCIDENT SUMMARY:

A/C JOHN MANION, KAUKAUNA Police Dept. requested this department to check the above area for a possible Hit + Run vehicle for MANITOWOC County Sheriff's Dept. See page two.

Lt. Bushman, MASA [REDACTED]

#2

FOX VALLEY METRO POLICE DEPARTMENT
SUPPLEMENTARY REPORT

Incident Number: 990029546
Date: Thursday, March 11, 1999
Reporting Officer: Captain Donald Stefanic

At 1545 hours this date, Assistant Chief John Manion, Kaukauna Police Department, notified me that they had received a crime stoppers tip that the vehicle that was involved in the hit and run fatality in Manitowoc County could be located at [REDACTED] North Holland Road, and that the owner of the vehicle was identified as John Verbeten. Assistant Chief Manion requested the area be checked for the possible vehicle. Assistant Chief Manion identified the vehicle as a late model full size Chevrolet Suburban truck, dark in color. Assistant Chief Manion informed me that if the vehicle matching this description was located, that I should contact Lieutenant Bushman, Manitowoc County Sheriff's Department, at extension [REDACTED].

While en route to the Holland Road address, Assistant Chief Manion advised me that the Verbeten suspect was on the telephone with their department at this time, and that John Verbeten was at [REDACTED] North Holland Road with the vehicle. I continued to proceed to [REDACTED] North Holland Road, where upon arrival, I made contact with John Verbeten and his father, James Verbeten. Upon arrival, I advised John Verbeten that I was requested by the Manitowoc Sheriff's Department to check his vehicle, which matched the description of a vehicle involved in a hit and run accident. John Verbeten related he had no problem with me checking his vehicle.

I observed the vehicle identified as a 1985 full size Chevrolet Suburban black in color. While checking the vehicle, I observed that the vehicle had driver's side front end damage, was missing the grill in the front, and had damage to the hood. I also observed that the passenger side portion of the windshield of the vehicle was cracked. John Verbeten related that approximately three months ago, he was involved in an accident in Stockbridge, and that he hit a pole but did not file a report. In further speaking with John Verbeten and his father, James Verbeten, they stated they believed the accident might have happened about

five months ago, somewhere between Thanksgiving and Christmas. John Verbeten said that a friend of his by the name of Tom Hatton, who lives in Stockbridge, was the passenger in the vehicle at the time of the accident, and his telephone number is [REDACTED].

I contacted Lieutenant Bushman, Manitowoc County Sheriff's Department, and related the information to him. Per his request, I also obtained the size of the vehicle tires. I advised Lieutenant Bushman that the tires on the vehicle were L524575/R16's. John Verbeten related that the grill for his vehicle was in his garage, and I requested him to retrieve it. John Verbeten returned with a silver colored plastic grill fully in tact except for a small crack up in the driver's side corner, which was consistent to the dent in the hood from striking some type of a pole.

Photographs were taken of the vehicle by Officer James Burke, Fox Valley Metro Police Department, and will be submitted to Manitowoc County Sheriff's Department, attention Lieutenant Bushman. Lieutenant Bushman related that even though the vehicle fit the description of the vehicle involved in their hit and run, he did not feel this was the vehicle in question. He thanked our department for our assistance. End of report.

03-15-99/tape/jms

FOX VALLEY METRO POLICE DEPARTMENT
VEHICLE INFORMATION

PART FIVE

Incident Number 990029546 Date 03-11-99 Officer 613
Status 4 Type OR Year 85 Make Chevrolet Model Suburban
Bike Wheel Size _____ Body Style 25 Top Color BLACK Shade _____ (Lt. or Dk.)
Bottom Color _ Shade _____ (Lt. or Dk.)
License TBG669 State WI Exp. Yr. 99 Type A A-Auto; C-Cycle; T-Truck; O-Other
VIN/Serial # _____ City of Bike Reg. _____
Insurance Co _____
Recovery Code _____ Vehicle Value or Damage Est. _____ SID# _____
Condition _____ Note _____

Incident Number
99 0029546

VEHICLE INFORMATION

Incident Number _____ Date _____ Officer _____
Status _____ Type _____ Year _____ Make _____ Model _____
Bike Wheel Size _____ Body Style _____ Top Color _____ Shade _____ (Lt. or Dk.)
Bottom Color _____ Shade _____ (Lt. or Dk.)
License _____ State _____ Exp. Yr. _____ Type _____ A-Auto; C-Cycle; T-Truck; O-Other
VIN/Serial # _____ City of Bike Reg. _____
Insurance Co _____
Recovery Code _____ Vehicle Value or Damage Est. _____ SID# _____
Condition _____ Note _____

VEHICLE INFORMATION

Incident Number _____ Date _____ Officer _____
Status _____ Type _____ Year _____ Make _____ Model _____
Bike Wheel Size _____ Body Style _____ Top Color _____ Shade _____ (Lt. or Dk.)
Bottom Color _____ Shade _____ (Lt. or Dk.)
License _____ State _____ Exp. Yr. _____ Type _____ A-Auto; C-Cycle; T-Truck; O-Other
VIN/Serial # _____ City of Bike Reg. _____
Insurance Co _____
Recovery Code _____ Vehicle Value or Damage Est. _____ SID# _____
Condition _____ Note _____

FOX VALLEY METRO POLICE DEPARTMENT
Photograph Identification Form

Taken By: J. BLAKE # 630 Date: 03/11/99 Time: 1645 Incident # 99006

Location: [REDACTED] N. Holland Village: LITTLE CHUTE

CAMERA USED: CANON T70 Lens Used: Normal (N) Wide (W) Other used: _____

Film Type: Color Black & White Polaroid Film Speed: 200

Light Used: Strobe (S) Existing Light (E) Strobe Used: _____

Direction Taken: North (N) South (S) East (E) West (W) Misc: _____

Item Photographed	Lens Used	F/Stop	Shutter Speed	Light	Distance	Direction Taken
FRONT OF VEHICLE TBG 669	N	F/ 9.5	125	E	15 FT	N
DRIVERS SIDE FRONT	N	F/ 6.7	125	E	15 FT	N/W
DRIVERS SIDE	N	F/ 15	125	E	15 FT	W
DRIVERS REAR	N	F/ 8	125	E	15 FT	S/W
PASSENGER SIDE	N	F/ 13	125	E	20 FT	E
PASSENGER SIDE FRONT	N	F/ 9.5	125	E	15 FT	N/E
WIND SHIELD	N	F/ 5.6	125	E	18 FT	N
PASSENGER FRONT WHEEL TREAD	N	F/ 6.	125	E	4 FT	N
DRIVER SIDE FRONT DAMAGE	N	F/ 6.7	125	E	4 FT	N
		F/				
		F/				
		F/				

1. CASE # S99 No 01977
 2. CLASSIFICATION 6,310,11
 3. CENSUS 521000

4. INCIDENT CS/S99-00242
 INCIDENT LOCATION Memorial Hospital Reed ave.

6. NAME- LAST-FIRST-MI [REDACTED] L 61323
 7. D.O.B [REDACTED]

8. ADDRESS [REDACTED]
 9. TX-HOME [REDACTED]
 11. CITY [REDACTED] STATE [REDACTED] ZIP [REDACTED]
 10. TX-BUSINESS [REDACTED]

12. DETAILS
 Reports there is a vehicle matching the description of our H&R vehicle from s99-00242 parked in the front lot at above location.

3-10-99 1235
 03-10-99 1235

14. REC'D. 15. DISP. 16. 10-23 17. 10-24
 13. DAY
 SUN 1 THU 5
 MON 2 FRI 6
 TUE 3 SAT 7
 WED 4

MANITOWOC COUNTY SHERIFF INCIDENT CARD

18. ASSIGNED
 MTSO 929
 MTPD 9315
 11
 11

19. REC. BY 923
 20. DIS. BY 923
 22. TYPE OF REPORT
 1. INCIDENT
 2. ACCIDENT
 3. CITATION
 4. NONE

21. HOW REC'D.
 1. 911
 2. POLICE RADIO
 3. PHONE
 4. TTY
 5. IN PERSON
 6. ON VIEW
 7. OFF. OFF DUTY
 8. C.B. RADIO
 9. OTHER
 21A. M.O.
 23. STATUS
 1. UNFOUNDED
 2. PNL
 3. OTHER
 4. CLEARED
 5. EXCEPT CLEARED
 24. DATE CLEARED 03/16/99
 25. OFFENSE TYPE
 1. ADULT NA
 2. JUVENILE
 3. UNKNOWN

39. (CODE S-SUSPECT W-WITNESS V-VICTIM O-OTHER)				42. ADDRESS		43. TELEPHONE	
CODE	40. NAME-LAST	FIRST	MI	41. D.O.B.			

MTPD Officer LeDuc was sent to check on this vehicle in question in the lot at Memorial Hospital on Reed Ave. Officer LeDuc obtained an RP# of dealer 759F mv from a dark blue GMC Sierra. Vehicle is an older 70's-80's model pick up with drivers side damage and drivers left turn signal broke. Also appears to be a yellow paint transfer. lak/lak
 03-10-99 I, Deputy Jost, made contact with Lloyd Seibold reference this complaint as he is the owner of the truck in question. I looked over the damage on the truck however it did not match what we are looking for. This truck is also a GMC not a Chevy. Vehicle was dark blue in color unable to read the vin number. An addition was made on the main report, no followup needed. *JMJ*

45. IF COMPLAINANT DIFFERENT THEN CALLER, ENTER NAME, ADDRESS, D.O.B., TELEPHONE:

46. IF CODE O (OTHER) IS USED IN FIELD #39, EXPLAIN.

INCIDENT REPORT: NOTE: IF SECTION 22 ABOVE HAS NUMBER 4 CHECKED, DO NOT GO BEYOND THIS LINE WITHOUT RECORDS SECTION BEING ADVISED, OR NO RECORD ENTRIES WILL BE MADE BELOW THIS LINE.

PROPERTY VALUE	26. PROPERTY	A. CURRENCY	B. JEWELRY	C. FURS CLOTHING	D. VEHICLE (LOCAL)	E. OFFICE EQUIPMENT	F. RADIO, TV CAMERAS	G. FIREARMS	H. HOUSEHOLD GOODS
	STOLEN	\$	\$	\$	\$	\$	\$	\$	\$
	RECOVERED	\$	\$	\$	\$	\$	\$	\$	\$
	26. PROPERTY	I. CONSUMABLES	J. LIVESTOCK	K. DRUGS	L. MARINE ITEMS	M. CONSTRUCTION ITEMS	N. LAWN AND GARDEN	O. SPORTING GOODS	P. MISC BICYCLE
	STOLEN	\$	\$	\$	\$	\$	\$	\$	\$
	RECOVERED	\$	\$	\$	\$	\$	\$	\$	\$

27. PROPERTY RECOVERED: LOCALLY _____ OTHER JURISDICTION _____ (INSERT O OR L)

PROPERTY ITEMIZATION	PROPERTY STOLEN/RECOVERED ITEMIZATION, USE THE FOLLOWING FORMAT				
	28. QUANTITY	29. ARTICLE NAME	30. BRAND NAME	31. SERIAL NUMBER	
					S <input type="checkbox"/> R <input type="checkbox"/>
					S <input type="checkbox"/> R <input type="checkbox"/>
					S <input type="checkbox"/> R <input type="checkbox"/>
					S <input type="checkbox"/> R <input type="checkbox"/>

33. PROPERTY DAMAGE AMOUNT \$ _____ 34. INSURANCE COMPANY _____

35. OFFICER ASSAULTED Y N 36. ARSON Y N 37. STRUCTURE CODE _____ 38. DAMAGE \$ _____

47. CIB ENTERED CANCELLED
 NCIC
 OTHER BROADCAST

48. TOTAL AMOUNT PROPERTY STOLEN \$ _____
 49. TOTAL AMOUNT PROPERTY RECOVERED \$ _____

50. IS REPORT CONTINUED? YES NO

51. CAUTION INDICATORS, ATLS ETC.

52. DATA PROCESS INFORMATION:

COMPUTER ENTERED DATE 3/16/99
 MICROFILM INDEXED INITIAL AS

53. FILE APPROVAL
 BY [Signature] DATE 03/16/99

IS CASE CLASSIFICATION CORRECT?
 IF N HAS CORRECTION BEEN MADE? Y N

1. CASE # S99 No 01978		2. CLASSIFICATION 63191, 141011		3. CENSUS	
4. INCIDENT CS/ 599-00242					
5. INCIDENT LOCATION Hwy CR & Silver Crk Rd.					
6. NAME - LAST - FIRST - MI Anonymous				7. D.O.B.	
8. ADDRESS			9. TX-HOME		
11. CITY		STATE		ZIP	
10. TX-BUSINESS			13. DAY		
12. DETAILS States Greg J. Schaefer DOB [redacted] owned a '83 Chev pickup 2-tone blue and abruptly gave					
14. REC'D		15. DISP		16. 10-23	
17. 10-24		18. 10-23		19. 10-24	
13. DAY SUN 1 THU 5 MON 2 FRI 6 TUE 3 SAT 7 WED 3					
MANITOWOC COUNTY SHERIFF INCIDENT CARD					
18. ASSIGNED Jost				4449 929	
19. REC. BY 925		20. DIS. BY 925		22. TYPE OF REPORT	
21. HOW REC'D. 1. 911 2. POLICE RADIO 3. PHONE 4. TTY 5. IN PERSON 6. ON VIEW 7. OFF. OFF DUTY 8. C.B. RADIO 9. OTHER				1. INCIDENT 2. ACCIDENT 3. CITATION 4. NONE	
23. STATUS 1. UNFOUNDED 2. PNL 3. OTHER 4. CLEARED 5. EXCEPT CLEARED				24. DATE CLEARED 10/16/99	
25. OFFENSE TYPE 1. ADULT <input type="checkbox"/> NA <input checked="" type="checkbox"/> 2. JUVENILE <input type="checkbox"/> 3. UNKNOWN <input type="checkbox"/>				21A. M.O.	
39. (CODE S-SUSPECT W-WITNESS V-VICTIM O-OTHER)					
40. NAME-LAST		41. D.O.B.		42. ADDRESS	
43. TELEPHONE		44. NAME-FIRST		45. MI	
① Schaefer		[redacted]		Sunset Crk. Two Rivers	
② SCHAEFER		[redacted]		SMILEY RD AMBURG, MARINETTE	
HOME		[redacted]		WILMOT	

it to his grand-father, Mark Schaefer, a few days after the fatal accident. Caller states Greg has a drinking problem, works second shift at Dayco Eastman, and usually goes out drinking afterwards. (One of the taverns he frequents is Desert Jacks). Caller states Greg works weekdays, and usually drank with Steven or Jeremy Welch, who lived together at the time on Sunset Crk., Two Rivers. Greg may have been in the area of Hwy CR & Silver Crk Rd. meeting with an unknown female party for a romantic relationship. Caller states Greg cleaned up the vehicle, including the windows (which was rare) before giving it to his grand-father. The vehicle had some rust and is kept parked at the back of the property owned by the grand-father on Smiley Rd., in the township of Amburg, the county of Marinette. Greg owned a third vehicle for at least one year which remained unused due to the fact that it needed a new engine installed. After giving his pick-up truck away, Greg quickly completed the work on this third vehicle. This info was immediately given to Officer Jost. SE SE

03-10-99 I, Deputy Jost, also spoke with the anonymous reporting person however I do not have any further information to add. Follow-up will need to be done as I was unable to do any further follow-up due to other crimestopper reports I was working on. *[Signature]*

03/11/99 1100hrs
Contact made by phone with Marinette Co. SO and request to assist. Dispatch requested a fax be sent of copy. Have Officer take a look at the vehicle and phone MISO while on scene to ask for Lt. Bushman if there are any questions.

Suspect vehicle we are looking for is an 85-early 88 Chev. P/U, Blazer, Suburban or an 89-91 Chev van. All vehicles will be a low end model Custom Delux or Scotsdale not a Silverado. Damage caused when suspect vehicle struck a 6'1 210# male being hit squarely from behind, impact on the vehicle front between passenger side headlamp and the center Chev. emblem. We have grill parts and fan shroud parts where the fan most have caught the edge of the shroud as the radiator wall was pushed backward. Radiator did not leak. M.J. Bushman 1214hrs Vehicle located by Off. Goerge Severson. Registration AH 55072. Veh. has single rectangular headlamps on each side, very small piece of grill damaged, no damage to bumper, hood or radiator wall. Grill was rounded on the bottom edge, This is not the vehicle we are looking for. M.J. Bushman *[Signature]*

CASE # S99 No 019

45. IF COMPLAINANT DIFFERENT THEN CALLER, ENTER NAME, ADDRESS, D.O.B., TELEPHONE.

46. IF CODE O (OTHER) IS USED IN FIELD #39, EXPLAIN.

INCIDENT REPORT: NOTE: IF SECTION 22 ABOVE HAS NUMBER 4 CHECKED, DO NOT GO BEYOND THIS LINE WITHOUT RECORDS SECTION BEING ADVISED, OR NO RECORD ENTRIES WILL BE MADE BELOW THIS LINE.

PROPERTY VALUE	26. PROPERTY	A. CURRENCY	B. JEWELRY	C. FURS CLOTHING	D. VEHICLE (LOCAL)	E. OFFICE EQUIPMENT	F. RADIO, TV CAMERAS	G. FIREARMS	H. HOUSE-HOLD GOODS
	STOLEN	\$	\$	\$	\$	\$	\$	\$	\$
	RECOVERED	\$	\$	\$	\$	\$	\$	\$	\$
	26. PROPERTY	I. CONSUM-ABLES	J. LIVESTOCK	K. DRUGS	L. MARINE ITEMS	M. CONSTRUCTION ITEMS	N. LAWN AND GARDEN	O. SPORTING GOODS	P. MISC BICYCLE
	STOLEN	\$	\$	\$	\$	\$	\$	\$	\$
	RECOVERED	\$	\$	\$	\$	\$	\$	\$	\$

27. PROPERTY RECOVERED: LOCALLY _____ OTHER JURISDICTION _____ (INSERT O OR L)

PROPERTY ITEMIZATION	PROPERTY STOLEN/RECOVERED ITEMIZATION, USE THE FOLLOWING FORMAT				
	28. QUANTITY	29. ARTICLE NAME	30. BRAND NAME	31. SERIAL NUMBER	32. CODE
					S R <input type="checkbox"/> <input type="checkbox"/>
					S R <input type="checkbox"/> <input type="checkbox"/>
					S R <input type="checkbox"/> <input type="checkbox"/>
					S R <input type="checkbox"/> <input type="checkbox"/>
					S R <input type="checkbox"/> <input type="checkbox"/>

33. PROPERTY DAMAGE AMOUNT \$ _____

34. INSURANCE COMPANY _____

35. OFFICER ASSAULTED Y N

36. ARSON Y N

37. STRUCTURE CODE _____

38. DAMAGE \$ _____

47. CIB ENTERED CANCELLED
 NCIC
 OTHER BROADCAST

48. TOTAL AMOUNT PROPERTY STOLEN \$ _____

49. TOTAL AMOUNT PROPERTY RECOVERED \$ _____

50. IS REPORT CONTINUED? YES NO

51. CAUTION INDICATORS, ATLS ETC.

52. DATA PROCESS INFORMATION:

COMPUTER ENTERED DATE 13/16/99
 MICROFILM INDEXED INITIAL KS

53. FILE APPROVAL

IS CASE CLASSIFICATION CORRECT? Y N
 IF N HAS CORRECTION BEEN MADE? Y N

BY [Signature] DATE 03/16/99

1. CASE # S99 No 01982 | 2. CLASSIFICATION 6310.11 | 3. CENSUS 70000

MANITOWOC COUNTY SHERIFF
INCIDENT CARD

4. INCIDENT CS/S99-00242

INCIDENT LOCATION Green Bay

6. NAME LAST-FIRST-MI Anonymous (2) | 7. D.O.B.

8. ADDRESS | 9. TX-HOME

11. CITY STATE ZIP | 10. TX-BUSINESS

12. DETAILS See Attached

03/10/99 1426

18. ASSIGNED MJSO 9129
444

19. REC. BY 935 | 20. DIS. BY

21. HOW REC'D. 1. 911 2. POLICE RADIO 3. PHONE 4. TTY 5. IN PERSON 6. ON VIEW 7. OFF. OFF DUTY 8. C.B. RADIO 9. OTHER

22. TYPE OF REPORT 1. INCIDENT 2. ACCIDENT 3. CITATION 4. NONE

23. STATUS 1. UNFOUNDED 2. PNL 3. OTHER 4. CLEARED 5. EXCEPT CLEARED

24. DATE CLEARED 03/16/99
25. OFFENSE TYPE 1. ADULT NA 2. JUVENILE 3. UNKNOWN

14. REC'D 15. DISP 16. 10-23 17. 10-24
13. DAY
SUN 1 THU 5
MON 2 FRI 6
TUE 3 SAT 7
WED 4

39. (CODE S-SUSPECT W-WITNESS V-VICTIM O-OTHER)				42. ADDRESS		43. TELEPHONE
CODE	40. NAME-LAST	FIRST	MI	41. D.O.B.		

03/11/99 1524hrs Attempted contact by phone to verify description of suspect vehicle observed as it did not match that of our suspect vehicle by the 10-28 information. Message left on the answering machine. M.J. Bushman
Received phone call back the vehicle in question was an 89-90 Chev pickup new style as noted by her husband. Close out. M.J. Bushman

45. IF COMPLAINANT DIFFERENT THEN CALLER, ENTER NAME, ADDRESS, D.O.B., TELEPHONE.

46. IF CODE O (OTHER) IS USED IN FIELD #39, EXPLAIN.

INCIDENT REPORT: NOTE: IF SECTION 22 ABOVE HAS NUMBER 4 CHECKED, DO NOT GO BEYOND THIS LINE WITHOUT RECORDS SECTION BEING ADVISED, OR NO RECORD ENTRIES WILL BE MADE BELOW THIS LINE.

PROPERTY VALUE	26. PROPERTY	A. CURRENCY	B. JEWELRY	C. FURS CLOTHING	D. VEHICLE (LOCAL)	E. OFFICE EQUIPMENT	F. RADIO, TV CAMERAS	G. FIREARMS	H. HOUSE-HOLD GOODS
	STOLEN	\$	\$	\$	\$	\$	\$	\$	\$
	RECOVERED	\$	\$	\$	\$	\$	\$	\$	\$
	26. PROPERTY	I. CONSUM-ABLES	J. LIVESTOCK	K. DRUGS	L. MARINE ITEMS	M. CONSTRUCTION ITEMS	N. LAWN AND GARDEN	O. SPORTING GOODS	P. MISC BICYCLE
STOLEN	\$	\$	\$	\$	\$	\$	\$	\$	
RECOVERED	\$	\$	\$	\$	\$	\$	\$	\$	

27. PROPERTY RECOVERED: LOCALLY _____ OTHER JURISDICTION _____ (INSERT O OR L)

PROPERTY ITEMIZATION	PROPERTY STOLEN/RECOVERED ITEMIZATION, USE THE FOLLOWING FORMAT				
	28. QUANTITY	29. ARTICLE NAME	30. BRAND NAME	31. SERIAL NUMBER	32. CODE
					S R <input type="checkbox"/> <input type="checkbox"/>
					S R <input type="checkbox"/> <input type="checkbox"/>
					S R <input type="checkbox"/> <input type="checkbox"/>
					S R <input type="checkbox"/> <input type="checkbox"/>
					S R <input type="checkbox"/> <input type="checkbox"/>

33. PROPERTY DAMAGE AMOUNT \$ _____

34. INSURANCE COMPANY _____

35. OFFICER ASSAULTED Y N

36. ARSON Y N

37. STRUCTURE CODE _____

38. DAMAGE \$ _____

47. CIB ENTERED CANCELLED
 NCIC
 OTHER BROADCAST

48. TOTAL AMOUNT PROPERTY STOLEN \$ _____

49. TOTAL AMOUNT PROPERTY RECOVERED \$ _____

50. IS REPORT CONTINUED? YES NO

51. CAUTION INDICATORS, ATLS ETC.

52. DATA PROCESS INFORMATION:

COMPUTER ENTERED DATE 3/16/99
 MICROFILM INDEXED INITIAL AS

53. FILE APPROVAL

IS CASE CLASSIFICATION CORRECT? Y N
 IF N HAS CORRECTION BEEN MADE? Y N

BY [Signature] DATE 3/16/99

1. CASE # S99 No 01997 2. CLASSIFICATION 031011 3. CENSUS 7,010,00

4. INCIDENT CS / S99-00242

5. INCIDENT LOCATION BROADWAY St. Deperu 32 | 57

6. NAME - LAST - FIRST - MI ANONY. 7. D.O.B.

8. ADDRESS 9. TX-HOME

11. CITY STATE ZIP 10. TX-BUSINESS

12. DETAILS See Attached.

REC'D 03-10-99 1750
DISP 10-23 10-24
13. DAY
SUN 1 THU 5
MON 2 FRI 6
TUE 3 SAT 7
WED 4

MANITOWOC COUNTY SHERIFF
INCIDENT CARD

18. ASSIGNED
Bushman 9191
MTSO 9129

19. REC. BY 938 20. DIS. BY
22. TYPE OF REPORT
1. INCIDENT
2. ACCIDENT
3. CITATION
4. NONE

21. HOW REC'D.
1. 911
2. POLICE RADIO
3. PHONE
4. TTY
5. IN PERSON
6. ON VIEW
7. OFF. OFF DUTY
8. C.B. RADIO
9. OTHER
23. STATUS
1. UNFOUNDED
2. PNL
3. OTHER
4. CLEARED
5. EXCEPT CLEARED

24. DATE CLEARED 03/30/99
25. OFFENSE TYPE
1. ADULT NA
2. JUVENILE
3. UNKNOWN

ACT FILE

39. (CODE S-SUSPECT W-WITNESS V-VICTIM O-OTHER)	40. NAME-LAST	FIRST	MI	41. D.O.B.	42. ADDRESS	43. TELEPHONE
0	Jandrain Religious Supply		17053H		Main St., Green Bay, Wi	

03/11/99 1518 hrs Contact made with Jandrain Rel Sup. Co. by phone. They have several vans but all are on the road at this time. Manager is out of the office for the remainder of the day. A good time to reach him 0900hrs 03/12/99. M.J.Bushman

03/12/99 1334hrs Contact made with one of the owners of the company with first name of Dennis. He advised they have two Chev. vans which are kept at the owners homes after hours. The van in question is driven by his partner who was currently out of the office. Dennis was not aware of any damage, he will check into the matter and call MTSO back. M.J.Bushman

03/13/99 1003hrs Contact made with Dennis at Jandrain Religious Supply. The van in question has two point of damage to the front. A 6 inch part of the grille is missing just to the passenger side of the center grill from striking a snow bank, and the bug shield is cracked from going through the car wash. Dennis advised Bob Gary of Gandrude Service in Green Bay can varify the damage as both have been on the vehicle for some time and Gary does most all the general service like oil change.

1006hrs Gandrude phoned. Bob Gary on days off, works Mon-Fri 0700hrs-1700hrs. M.J.Bushman
468-3657

03/16/99 1530hrs Contact made with Bob Gary and he advised he does most all the service for the van in question driven by Jeff. There has been no major damage on the gray van, by major he means nothing a body shop would be required to repair. Minor dings here and there nothing major. Vehicle was just in for a minor radiator leak, oil changes regularly.
Close Out. M.J.Bushman

CASE # S99 No 01997

15020

45. IF COMPLAINANT DIFFERENT THEN CALLER, ENTER NAME, ADDRESS, D.O.B., TELEPHONE.

46. IF CODE O (OTHER) IS USED IN FIELD #39, EXPLAIN.

INCIDENT REPORT: NOTE: IF SECTION 22 ABOVE HAS NUMBER 4 CHECKED, DO NOT GO BEYOND THIS LINE WITHOUT RECORDS SECTION BEING ADVISED, OR NO RECORD ENTRIES WILL BE MADE BELOW THIS LINE.

PROPERTY VALUE	26. PROPERTY	A. CURRENCY	B. JEWELRY	C. FURS CLOTHING	D. VEHICLE (LOCAL)	E. OFFICE EQUIPMENT	F. RADIO, TV CAMERAS	G. FIREARMS	H. HOUSE-HOLD GOODS
	STOLEN	\$	\$	\$	\$	\$	\$	\$	\$
	RECOVERED	\$	\$	\$	\$	\$	\$	\$	\$
	26. PROPERTY	I. CONSUMABLES	J. LIVESTOCK	K. DRUGS	L. MARINE ITEMS	M. CONSTRUCTION ITEMS	N. LAWN AND GARDEN	O. SPORTING GOODS	P. MISC BICYCLE
STOLEN	\$	\$	\$	\$	\$	\$	\$	\$	
RECOVERED	\$	\$	\$	\$	\$	\$	\$	\$	

27. PROPERTY RECOVERED: LOCALLY _____ OTHER JURISDICTION _____ (INSERT O OR L)

PROPERTY ITEMIZATION	PROPERTY STOLEN/RECOVERED ITEMIZATION, USE THE FOLLOWING FORMAT			
	28. QUANTITY	29. ARTICLE NAME	30. BRAND NAME	31. SERIAL NUMBER
				S R <input type="checkbox"/> <input type="checkbox"/>
				S R <input type="checkbox"/> <input type="checkbox"/>
				S R <input type="checkbox"/> <input type="checkbox"/>
				S R <input type="checkbox"/> <input type="checkbox"/>
				S R <input type="checkbox"/> <input type="checkbox"/>
				S R <input type="checkbox"/> <input type="checkbox"/>

33. PROPERTY DAMAGE AMOUNT \$ _____

34. INSURANCE COMPANY _____

35. OFFICER ASSAULTED Y N

36. ARSON Y N

37. STRUCTURE CODE _____

38. DAMAGE \$ _____

47. CIB ENTERED CANCELLED
 NCIC
 OTHER BROADCAST

48. TOTAL AMOUNT PROPERTY STOLEN \$ _____

49. TOTAL AMOUNT PROPERTY RECOVERED \$ _____

50. IS REPORT CONTINUED? YES NO

51. CAUTION INDICATORS, ATLS ETC.

52. DATA PROCESS INFORMATION:

COMPUTER ENTERED DATE 3/31/99
 MICROFILM INDEXED INITIAL AS

53. FILE APPROVAL

BY OK DATE 10/30/99

IS CASE CLASSIFICATION CORRECT?
 IF N HAS CORRECTION BEEN MADE? N N

S99 No 02002 2. CLASSIFICATION 6,310,11 3. CENSUS 1,812,1,6

4. INCIDENT CS / S99-00242

5. INCIDENT LOCATION [REDACTED] CTH 0

6. NAME - LAST - FIRST - MI Anony. (2) 7. D.O.B.

8. ADDRESS 9. TX-HOME

11. CITY STATE ZIP 10. TX-BUSINESS

12. DETAILS See Attached

03-10-99 219

MANITOWOC COUNTY SHERIFF INCIDENT CARD

18. ASSIGNED MTSO 91219
H/K/K

19. REC. BY 938 20. DIS. BY

22. TYPE OF REPORT
 1. INCIDENT
 2. ACCIDENT
 3. CITATION
 4. NONE

23. STATUS
 1. UNFOUNDED
 2. PNL
 3. OTHER
 4. CLEARED
 5. EXCEPT CLEARED

24. DATE CLEARED 03/16/99

25. OFFENSE TYPE
 1. ADULT NA
 2. JUVENILE
 3. UNKNOWN

21. HOW REC'D.
 1. 911
 2. POLICE RADIO
 3. PHONE
 4. TTY
 5. IN PERSON
 6. ON VIEW
 7. OFF. OFF DUTY
 8. C.B. RADIO
 9. OTHER

21A. M.O.

14. REC'D.	15. DISP	16. 10-23	17. 10-24
13. DAY			
SUN 1	THU 5		
MON 2	FRI 6		
TUE 3	SAT 7		
WED 4			

39. (CODE S-SUSPECT W-WITNESS V-VICTIM O-OTHER)

CODE	40. NAME - LAST	FIRST	MI	41. D.O.B.	42. ADDRESS	43. TELEPHONE

03/11/99 1025hrs Point Beach Nuclear Plant Security representative Joan McCullen and Brian Kopetsky called. Both away from their desk, message left requesting assistance. M.J. Bushman 1055hrs Kopetsky returned call to MTSO. Point Beach has over 500 vehicles on any given day come onto their property in their North or South parking lot. His comment was "We only wish we had record of every vehicle on Point Beach Property." With out further information like the registration its impossible to followup at this time. Close out. M.J. Bushman

CASE # S99 No 02002

45. IF COMPLAINANT DIFFERENT THEN CALLER, ENTER NAME, ADDRESS, D.O.B., TELEPHONE

46. IF CODE O (OTHER) IS USED IN FIELD #39, EXPLAIN.

INCIDENT REPORT: NOTE: IF SECTION 22 ABOVE HAS NUMBER 4 CHECKED, DO NOT GO BEYOND THIS LINE WITHOUT RECORDS SECTION BEING ADVISED, OR NO RECORD ENTRIES WILL BE MADE BELOW THIS LINE.

PROPERTY VALUE	26. PROPERTY	A. CURRENCY	B. JEWELRY	C. FURS CLOTHING	D. VEHICLE (LOCAL)	E. OFFICE EQUIPMENT	F. RADIO, TV CAMERAS	G. FIREARMS	H. HOUSE-HOLD GOODS
	STOLEN	\$	\$	\$	\$	\$	\$	\$	\$
	RECOVERED	\$	\$	\$	\$	\$	\$	\$	\$
	26. PROPERTY	I. CONSUMABLES	J. LIVESTOCK	K. DRUGS	L. MARINE ITEMS	M. CONSTRUCTION ITEMS	N. LAWN AND GARDEN	O. SPORTING GOODS	P. MISC BICYCLE
STOLEN	\$	\$	\$	\$	\$	\$	\$	\$	
RECOVERED	\$	\$	\$	\$	\$	\$	\$	\$	

27. PROPERTY RECOVERED: LOCALLY _____ OTHER JURISDICTION _____ (INSERT O OR L)

PROPERTY ITEMIZATION	PROPERTY STOLEN/RECOVERED ITEMIZATION, USE THE FOLLOWING FORMAT	30. BRAND NAME	31. SERIAL NUMBER	32. CODE	
	28. QUANTITY	29. ARTICLE NAME		S	R
				<input type="checkbox"/>	<input type="checkbox"/>
				<input type="checkbox"/>	<input type="checkbox"/>
				<input type="checkbox"/>	<input type="checkbox"/>
				<input type="checkbox"/>	<input type="checkbox"/>
				<input type="checkbox"/>	<input type="checkbox"/>
				<input type="checkbox"/>	<input type="checkbox"/>

33. PROPERTY DAMAGE AMOUNT \$ _____ 34. INSURANCE COMPANY _____

35. OFFICER ASSAULTED Y N 36. ARSON Y N 37. STRUCTURE CODE _____ 38. DAMAGE \$ _____

47. CIB ENTERED CANCELLED
 NCIC
 OTHER BROADCAST

48. TOTAL AMOUNT PROPERTY STOLEN \$ _____
 49. TOTAL AMOUNT PROPERTY RECOVERED \$ _____

50. IS REPORT CONTINUED? YES NO 51. CAUTION INDICATORS, ATLS ETC.

52. DATA PROCESS INFORMATION:
 COMPUTER ENTERED DATE 13/16/99
 MICROFILM INDEXED INITIAL KS
 IS CASE CLASSIFICATION CORRECT? Y N
 IF N HAS CORRECTION BEEN MADE? Y N

53. FILE APPROVAL
 BY [Signature] DATE 03/16/99

1. CASE # S99 No 02009 2. CLASSIFICATION 6310.11 3. CENSUS 7,060.0

4. INCIDENT CS/599-00242
INCIDENT LOCATION

6. NAME - LAST - FIRST - MI Anonamous 7. D.O.B.

8. ADDRESS 9. TX-HOME

11. CITY STATE ZIP 10. TX-BUSINESS

12. DETAILS See attached sheet.

14. REC'D. 15. DISP. 16. 10-23 17. 10-24
0600 031199
13. DAY
SUN 1 THU 5
MON 2 FRI 6
TUE 3 SAT 7
WED 4

MANITOWOC COUNTY SHERIFF
INCIDENT CARD

18. ASSIGNED
CJ BUSHMAN 4/4/11
MTSO 9/2/9

19. REC. BY 922 20. DIS. BY 922
22. TYPE OF REPORT
① INCIDENT
2. ACCIDENT
3. CITATION
4. NONE

21. HOW REC'D.
1. 911
2. POLICE RADIO
3. PHONE
4. TTY
5. IN PERSON
6. ON VIEW
7. OFF. OFF DUTY
8. C.B. RADIO
9. OTHER
23. STATUS
1. UNFOUNDED
2. PNL
3. OTHER
4. CLEARED
5. EXCEPT CLEARED
24. DATE CLEARED 03/16/99

21A.M.O. 25. OFFENSE TYPE
1. ADULT NA
2. JUVENILE
3. UNKNOWN

39. (CODE S-SUSPECT W-WITNESS V-VICTIM O-OTHER)						
CODE	40. NAME-LAST	FIRST	MI	41. D.O.B.	42. ADDRESS	43. TELEPHONE
0	Kalmon, Steve				9th St. Green Bay	

03/11/99 1149hrs Contact made by phone with [redacted]. He stated he bought the vehicle unregistered from a party out of Lena, Wisconsin. It was part of a divorce action and the seller was in a hurry to get rid of it. Vehicle is an 84 Chev Blazer. Damage consist of a cut to the bumper pad. There is no damage to the grille, radiator wall or shroud, nor does it look like the shroud or wall was repaired. This vehicle has 4 headlamps and the grille is rounded on the bottom edges not square. This is not a suspect vehicle. M.J. Bushman

45. IF COMPLAINANT DIFFERENT THEN CALLER, ENTER NAME, ADDRESS, D.O.B., TELEPHONE.

46. IF CODE O (OTHER) IS USED IN FIELD #39, EXPLAIN.

INCIDENT REPORT: NOTE: IF SECTION 22 ABOVE HAS NUMBER 4 CHECKED, DO NOT GO BEYOND THIS LINE WITHOUT RECORDS SECTION BEING ADVISED, OR NO RECORD ENTRIES WILL BE MADE BELOW THIS LINE.

PROPERTY VALUE	26. PROPERTY	A. CURRENCY	B. JEWELRY	C. FURS CLOTHING	D. VEHICLE (LOCAL)	E. OFFICE EQUIPMENT	F. RADIO, TV CAMERAS	G. FIREARMS	H. HOUSE-HOLD GOODS
	STOLEN	\$	\$	\$	\$	\$	\$	\$	\$
	RECOVERED	\$	\$	\$	\$	\$	\$	\$	\$
	26. PROPERTY	I. CONSUM-ABLES	J. LIVESTOCK	K. DRUGS	L. MARINE ITEMS	M. CONSTRUCTION ITEMS	N. LAWN AND GARDEN	O. SPORTING GOODS	P. MISC BICYCLE
	STOLEN	\$	\$	\$	\$	\$	\$	\$	\$
	RECOVERED	\$	\$	\$	\$	\$	\$	\$	\$

27. PROPERTY RECOVERED: LOCALLY _____ OTHER JURISDICTION _____ (INSERT O OR L)

PROPERTY ITEMIZATION	PROPERTY STOLEN/RECOVERED ITEMIZATION, USE THE FOLLOWING FORMAT				
	28. QUANTITY	29. ARTICLE NAME	30. BRAND NAME	31. SERIAL NUMBER	32. CODE
					S <input type="checkbox"/> R <input type="checkbox"/>
					S <input type="checkbox"/> R <input type="checkbox"/>
					S <input type="checkbox"/> R <input type="checkbox"/>
					S <input type="checkbox"/> R <input type="checkbox"/>
					S <input type="checkbox"/> R <input type="checkbox"/>

33. PROPERTY DAMAGE AMOUNT \$ _____ 34. INSURANCE COMPANY _____

35. OFFICER ASSAULTED Y N 36. ARSON Y N 37. STRUCTURE CODE _____ 38. DAMAGE \$ _____

47. CIB	ENTERED <input type="checkbox"/>	CANCELLED <input type="checkbox"/>	48. TOTAL AMOUNT PROPERTY STOLEN \$ _____
NCIC	<input type="checkbox"/>	<input type="checkbox"/>	
OTHER BROADCAST	<input type="checkbox"/>	<input type="checkbox"/>	
			49. TOTAL AMOUNT PROPERTY RECOVERED \$ _____

50. IS REPORT CONTINUED? YES NO 51. CAUTION INDICATORS, ATLS ETC.

52. DATA PROCESS INFORMATION:

COMPUTER ENTERED DATE 3/16/99

MICROFILM INDEXED INITIAL AS

IS CASE CLASSIFICATION CORRECT? IF N HAS CORRECTION BEEN MADE? Y N

53. FILE APPROVAL

BY [Signature] DATE 03/16/99

1. CASE # S99 No 02013 2. CLASSIFICATION 6.3011 3. CENSUS 5.20.00

4. INCIDENT # CS/S99-00242

5. INCIDENT LOCATION

6. NAME - LAST-FIRST-MI Anonymous 7. D.O.B.

8. ADDRESS 9. TX-HOME

11. CITY STATE ZIP 10. TX-BUSINESS

12. DETAILS
 SCOTT S. DUELLMAN has Chev. P/U -
 Neither he nor the P/U have been
 seen since the accident.

0889 031199

MANITOWOC COUNTY SHERIFF INCIDENT CARD

18. ASSIGNED SWETLIK (MPD)

19. REC. BY 932 20. DIS. BY
 22. TYPE OF REPORT
 1. INCIDENT
 2. ACCIDENT
 3. CITATION
 4. NONE

21. HOW REC'D.
 1. 911
 2. POLICE RADIO
 3. PHONE
 4. TTY
 5. IN PERSON
 6. ON VIEW
 7. OFF. OFF DUTY
 8. C.B. RADIO
 9. OTHER

23. STATUS
 1. UNFOUNDED
 2. PNL
 3. OTHER
 4. CLEARED
 5. EXCEPT CLEARED

14. REC'D 15. DISP 16. 10-23 17. 10-24
 13. DAY
 SUN 1 THU 5
 MON 2 FRI 6
 TUE 3 SAT 7
 WED 4

24. DATE CLEARED 03/20/99
 25. OFFENSE TYPE
 1. ADULT
 2. JUVENILE
 3. UNKNOWN

39. (CODE S-SUSPECT W-WITNESS V-VICTIM O-OTHER)				41. D.O.B.	42. ADDRESS	43. TELEPHONE
CODE	40. NAME-LAST	FIRST	MI			
S.	DUELLMAN	SCOTT	S.	[REDACTED]		

03/12/99 1354hrs Requested assistance from Manitowoc PD Detective Swetlik attempt to track down Scott S. Duellman. M.J. Bushman
 03/22/99 Brief discussion with Det. Dick City PD. He has located Duellman's residence, and a possible Chev truck he was driving by a past violation warning issued by a patrolman and entered in inhouse. No completed at this time. M.J. Bushman
 03/26/99 Contact by phone made with Det. Dick and this complaint is very near close. His report should be forthcoming within days. M.J. Bushman
 04/07/99 report received from Manitowoc PD, Close out. M.J. Bushman

45. IF COMPLAINANT DIFFERENT THEN CALLER, ENTER NAME, ADDRESS, D.O.B., TELEPHONE.

46. IF CODE O (OTHER) IS USED IN FIELD #39, EXPLAIN.

INCIDENT REPORT: NOTE: IF SECTION 22 ABOVE HAS NUMBER 4 CHECKED, DO NOT GO BEYOND THIS LINE WITHOUT RECORDS SECTION BEING ADVISED, OR NO RECORD ENTRIES WILL BE MADE BELOW THIS LINE.

PROPERTY VALUE	26. PROPERTY	A. CURRENCY	B. JEWELRY	C. FURS CLOTHING	D. VEHICLE (LOCAL)	E. OFFICE EQUIPMENT	F. RADIO, TV CAMERAS	G. FIREARMS	H. HOUSE-HOLD GOODS
	STOLEN	\$	\$	\$	\$	\$	\$	\$	\$
	RECOVERED	\$	\$	\$	\$	\$	\$	\$	\$
	26. PROPERTY	I. CONSUMABLES	J. LIVESTOCK	K. DRUGS	L. MARINE ITEMS	M. CONSTRUCTION ITEMS	N. LAWN AND GARDEN	O. SPORTING GOODS	P. MISC BICYCLE
STOLEN	\$	\$	\$	\$	\$	\$	\$	\$	
RECOVERED	\$	\$	\$	\$	\$	\$	\$	\$	

27. PROPERTY RECOVERED: LOCALLY _____ OTHER JURISDICTION _____ (INSERT O OR L)

PROPERTY ITEMIZATION	PROPERTY STOLEN/RECOVERED ITEMIZATION, USE THE FOLLOWING FORMAT				
	28. QUANTITY	29. ARTICLE NAME	30. BRAND NAME	31. SERIAL NUMBER	32. CODE
					S <input type="checkbox"/> R <input type="checkbox"/>
					S <input type="checkbox"/> R <input type="checkbox"/>
					S <input type="checkbox"/> R <input type="checkbox"/>
					S <input type="checkbox"/> R <input type="checkbox"/>

33. PROPERTY DAMAGE AMOUNT \$ _____ 34. INSURANCE COMPANY _____

35. OFFICER ASSAULTED Y N 36. ARSON Y N 37. STRUCTURE CODE _____ 38. DAMAGE \$ _____

47. CIB ENTERED CANCELLED
 NCIC
 OTHER BROADCAST

48. TOTAL AMOUNT PROPERTY STOLEN \$ _____
 49. TOTAL AMOUNT PROPERTY RECOVERED \$ _____

50. IS REPORT CONTINUED? YES NO

51. CAUTION INDICATORS, ATLS ETC.

52. DATA PROCESS INFORMATION:
 COMPUTER ENTERED DATE 10/29/99
 MICROFILM INDEXED INITIAL JS
 IS CASE CLASSIFICATION CORRECT? N
 IF N HAS CORRECTION BEEN MADE? N

53. FILE APPROVAL
 BY Gmx DATE 10/20/99

MTSO - M. Duellman

CITY OF MANITOWOC				DEPARTMENT OF POLICE				OFFENSE REPORT			
3. CENSUS NO. 2084		4. INCIDENT Assist MTSO/Hit&Run Hochstetler				13. DAY SUN 1 THUR 5		18. OFFICERS Dick		NO. 879	
2. CLASSIFICATION 5715		5. INCIDENT LOCATION [REDACTED] S 33rd Street				MON 2 FRI 6					
TUES 3 SAT 7		6. NAME LAST MTSO		FIRST MI		NUMBER 46		7. D.O.B.		14. DATE 3-12-99	
8. ADDRESS [REDACTED] S 9th St.		9. PHONE-HOME		14. TIME 1354							
11. CITY Manitowoc		STATE WI		ZIP CODE 54220		10. PHONE-WORK [REDACTED]		21. HOW REC'D (3) PHONE		6. ON VIEW 9. OTHER	
22. TYPE OF REPORT 1. INCIDENT		23. STATUS 1. UNFOUNDED		24. DATE CLEARED 3 25 99		25. OFFENSE TYPE 1. ADULT		19. REC'D BY Swetlik 747		ENTERED D P BY DATE	
2. ACCIDENT		2. PENDING				2. JUVENILE		7. OFF. OFF DUTY		MAR 25 1999	
3. CITATION		3. CLEARED				3. UNKNOWN		5. IN PERSON		8. C.B. RADIO	
4. NONE		4. CLEARED BY ARREST						8. C.B. RADIO			
5. EXCEPT CLEARED											
39. (CODE S-SUSPECT W-WITNESS V-VICTIM O-OTHER)											
CODE	40. NAME - LAST FIRST MI			41. DOB	NUMBER	42. ADDRESS			43. TELEPHONE		
O	Duellman, Scott S.			[REDACTED]	5795	[REDACTED] S 33rd St., Mtwc			[REDACTED]		
O	Duellman, Shelly L.			[REDACTED]	125150	same					

1. CASE NUMBER
99
No. 02515

THIS DOCUMENT IS THE PROPERTY OF THE
MANITOWOC POLICE DEPARTMENT. A COPY
IS BEING PROVIDED AT YOUR REQUEST, BUT
ITS CONTENTS ARE DEEMED CONFIDENTIAL
AND NOT TO BE DISSEMINATED.

RICHARD H GREY
CHIEF OF POLICE

On 3/12/99, Det. Sgt. Brian Swetlik was contacted by the Sheriff's Dept. to try and track down a vehicle owned by SCOTT DUELLMAN. They received a Crimestoppers, (S99-02013) that stated SCOTT DUELLMAN has a Chevy pick up. Neither he or the pick up has been seen since the accident. I did make several drive-bys in an attempt to find the vehicle but was not successful.

On 3/23/99 I, Det. Dick, stopped at [REDACTED] S. 33rd Street and spoke with SHELLY DUELLMAN. SHELLY DUELLMAN said that her husband was gone to [REDACTED] tonight. She said that he would call me when he got back home.

On 3/24/99, Capt. Bergner checked his answering machine and found a message from SCOTT DUELLMAN from the day before. Capt. Bergner did leave me a note indicating DUELLMAN had called me back.

On 3/25/99 I, Det. Dick, again stopped at the DUELLMAN residence and spoke with SHELLY DUELLMAN. She again said that her husband was gone to [REDACTED]. I then told her that I was doing some follow up on the HOCHSTETLER Hit & run. Because a couple days had passed, she said she and her husband were able to question each other as to why the police would stop at their house. They agreed that it was probably in some regard to the Hit & Run incident. She explained that in the early part of December 1998, the Elkhart Lake P.D. seized their pick up truck because SCOTT DUELLMAN had been arrested in that city for his fourth time OWI. She said that as of this time they are down to one car and that SCOTT

Signed: _____
SHIFT COMMANDER

does not drive. She said that he has [REDACTED] SHELLY DUELLMAN also said that a police officer did come to their house once before and this information was given to him once before.

I then returned to the Police Dept. and called the Elkhart P.D. It was confirmed that the DUELLMAN truck had been seized in December for the OWI incident. The truck was auctioned off about a month and a half ago. I was told that they would call back with the exact dates of the seizure and auction.

It should be noted that I did go through the contacts that SCOTT DUELLMAN has had with Law Enforcement in Manitowoc County. I did find that on June 1, 1998, he was issued a ticket by MTSO. The number for that ticket was **SX748670-A**. On the ticket it indicated that a red GMC truck was being driven by DUELLMAN with Plate #CC36-660. When I ran this plate it came back to CAROL J. KLITZKE from KLITZKE CONSTRUCTION in Black Creek. I did phone the KLITZKE residence and CAROL told me that she did own that Construction firm but auctioned off all the equipment last April. She said that the truck in question was bought by Gulseth Construction. All the trucks at Gulseth Construction have previously been checked by City of Manitowoc Police Officers and no evidence of their being involved in the Hit & Run was found.

Det. O. Dick/fm

THIS DOCUMENT IS THE PROPERTY OF THE
MANITOWOC POLICE DEPARTMENT AND IS
BEING PROVIDED AT YOUR REQUEST.
ITS CONTENTS ARE DEEMED CONFIDENTIAL
AND NOT TO BE DISSEMINATED
RICHARD H. GREY
CHIEF OF POLICE

1. CASE # S99 No 02023		2. CLASSIFICATION 630.11		3. CENSUS 520.00	
4. INCIDENT OS/S99-00 242					
5. INCIDENT LOCATION					
6. NAME - LAST - FIRST - MI Anonymous				7. D.O.B.	
8. ADDRESS			9. TX-HOME		
11. CITY		STATE	ZIP	10. TX-BUSINESS	
12. DETAILS See Attached					
14. REC'D	15. DISP	16. 10-23	17. 10-24	13. DAY SUN 1 THU 5 MON 2 FRI 6 TUE 3 SAT 7 WED 4	
19. REC. BY 935		20. DIS. BY		22. TYPE OF REPORT 1. INCIDENT 2. ACCIDENT 3. CITATION 4. NONE	
21. HOW REC'D. 1. 911 2. POLICE RADIO 3. PHONE 4. TTY 5. IN PERSON 6. ON VIEW 7. OFF. OFF DUTY 8. C.B. RADIO 9. OTHER		23. STATUS 1. UNFOUNDED 2. PNL 3. OTHER 4. CLEARED 5. EXCEPT CLEARED		24. DATE CLEARED 03/16/99	
21A. M.O.		25. OFFENSE TYPE 1. ADULT <input type="checkbox"/> NA <input checked="" type="checkbox"/> 2. JUVENILE <input type="checkbox"/> 3. UNKNOWN <input type="checkbox"/>			

03/11/99 1538

MANITOWOC COUNTY SHERIFF
INCIDENT CARD

18. ASSIGNED MTSO	929 4411
----------------------	-------------

39. (CODE S-SUSPECT W-WITNESS V-VICTIM O-OTHER)	40. NAME - LAST	FIRST	MI	41. D.O.B.	42. ADDRESS	43. TELEPHONE
0	Stueck Karl S.	20369			Thunder Rd., Manitowoc	

03/13/99 1220hrs Contact made with Stueck at [redacted] Thunder Road. As I walked into an out building on the property I heard music playing from, I noted the 84 Chev. Corvette with the hood up. It was dirty from an extended sit in a barn type building. There was snow blown in front of it and it had not been moved. Stueck was charging the battery. An 84 Ford P/U with BD85589 registration was parked outside. Stueck was very cooperative saying he indeed had a 1979 Ford van he sold last fall as the transmission was gone. He sold it to a Daniel Eucher (he was unsure of spelling) on So. 19th St, Mtwc Ph: [redacted]. Stueck stated he works for the railroad and when he had out of town assignments he would sleep in the van. He does not nor has he owned any Chevrolet matching the models we are looking for in the Hit and Run complaint.

1235hrs and 1415hrs attempt was made to contact Dan Eucher by phone, no answer. M.J. Bushman In light of the type vehicle involved the complaint can be closed. M.J. Bushman

The complainant could not provide any additional information about any damage to Stueck's vehicle stating, "I haven't seen it". She had no idea what type vehicle it was, only that it was a van and [redacted]

MJB

45. IF COMPLAINANT DIFFERENT THEN CALLER, ENTER NAME, ADDRESS, D.O.B., TELEPHONE.

46. IF CODE O (OTHER) IS USED IN FIELD #39, EXPLAIN.

INCIDENT REPORT: NOTE: IF SECTION 22 ABOVE HAS NUMBER 4 CHECKED, DO NOT GO BEYOND THIS LINE WITHOUT RECORDS SECTION BEING ADVISED, OR NO RECORD ENTRIES WILL BE MADE BELOW THIS LINE.

PROPERTY VALUE	26. PROPERTY	A. CURRENCY	B. JEWELRY	C. FURS CLOTHING	D. VEHICLE (LOCAL)	E. OFFICE EQUIPMENT	F. RADIO, TV CAMERAS	G. FIREARMS	H. HOUSE-HOLD GOODS
	STOLEN	\$	\$	\$	\$	\$	\$	\$	\$
	RECOVERED	\$	\$	\$	\$	\$	\$	\$	\$
	26. PROPERTY	I. CONSUMABLES	J. LIVESTOCK	K. DRUGS	L. MARINE ITEMS	M. CONSTRUCTION ITEMS	N. LAWN AND GARDEN	O. SPORTING GOODS	P. MISC BICYCLE
	STOLEN	\$	\$	\$	\$	\$	\$	\$	\$
	RECOVERED	\$	\$	\$	\$	\$	\$	\$	\$

27. PROPERTY RECOVERED: LOCALLY ____ OTHER JURISDICTION ____ (INSERT O OR L)

PROPERTY ITEMIZATION	PROPERTY STOLEN/RECOVERED ITEMIZATION, USE THE FOLLOWING FORMAT				
	28. QUANTITY	29. ARTICLE NAME	30. BRAND NAME	31. SERIAL NUMBER	32. CODE
					S <input type="checkbox"/> R <input type="checkbox"/>
					S <input type="checkbox"/> R <input type="checkbox"/>
					S <input type="checkbox"/> R <input type="checkbox"/>
					S <input type="checkbox"/> R <input type="checkbox"/>
					S <input type="checkbox"/> R <input type="checkbox"/>

33. PROPERTY DAMAGE AMOUNT \$ _____

34. INSURANCE COMPANY _____

35. OFFICER ASSAULTED Y N 36. ARSON Y N 37. STRUCTURE CODE _____ 38. DAMAGE \$ _____

47. CIB ENTERED CANCELLED
 NCIC
 OTHER BROADCAST

48. TOTAL AMOUNT PROPERTY STOLEN \$ _____

49. TOTAL AMOUNT PROPERTY RECOVERED \$ _____

50. IS REPORT CONTINUED? YES NO

51. CAUTION INDICATORS, ATLS ETC.

52. DATA PROCESS INFORMATION:

COMPUTER ENTERED DATE 5/16/99

MICROFILM INDEXED INITIAL AB

IS CASE CLASSIFICATION CORRECT? Y N
 IF N HAS CORRECTION BEEN MADE? Y N

53. FILE APPROVAL

BY [Signature] DATE 5/16/99

1. CASE # S99 No 02046 2. CLASSIFICATION 6310.11 3. CENSUS 7,010,000

4. INCIDENT CS See: 599-00242

6: NAME - LAST - FIRST - MI ANONYMOUS (2) 7. D.O.B.

8. ADDRESS 9. TX-HOME

11. CITY STATE ZIP 10. TX-BUSINESS

12. DETAILS COMPL. REPORTS SUBJECT W/ '87

CHEV TRK PLACED CARDBOARD IN

GRILL & CHANGED TIRES ON VEH.

AFTER 1-10-99 / SEE ATTACHED

MANITOWOC COUNTY SHERIFF INCIDENT CARD

18. ASSIGNED M.J. Bushman H/H/H
MTSO 929

19. REC. BY 930 20. DIS. BY 930
22. TYPE OF REPORT
1. INCIDENT
2. ACCIDENT
3. CITATION
4. NONE

21. HOW REC'D.
1. 911
2. POLICE RADIO
3. PHONE
4. TTY
5. IN PERSON
6. ON VIEW
7. OFF. OFF DUTY
8. C.B. RADIO
9. OTHER
23. STATUS
1. UNFOUNDED
2. PNL
3. OTHER
4. CLEARED
5. EXCEPT CLEARED

24. DATE CLEARED 03/30/99
25. OFFENSE TYPE
1. ADULT NA
2. JUVENILE
3. UNKNOWN

1245 03-12-99
1315 03-12-99
14. REC'D
15. DISP
16. 10-23
17. 10-24
13. DAY
SUN 1 THU 5
MON 2 FR 6
TUE 3 SAT 7
WED 4

MICHIGAN

39. (CODE S-SUSPECT W-WITNESS V-VICTIM O-OTHER)	40. NAME-LAST	FIRST	MI	41. D.O.B.	42. ADDRESS	43. TELEPHONE
0	Hocking, Joseph W. Jr	Joseph			River Bend Dr. Hingham	
0	Hocking, Joseph W. Sr.	Joseph			River Bend Dr. Hingham	

03/12/99 1420hrs Contact made Sheboygan PD and Information on Joseph Jr. obtained, listed above.

Contact made with an anonymous source who advised Joe Jr. does drive an 87 Chev truck dark blu with white cap. It did have cardboard in the grill and also has very large mud tires raising the vehicle unusually high. In their opinion Joe Jr. would be capable of the hit and run. Source did not know when the damage to the vehicle occurred, but stated for me to talk with his dad (same name) who has always cleaned up Joe Jr's mess and would be very cooperative. Truck was purchased from a Todd Ph: [redacted] possibly last summer. Message left with Todd's sister as he was not at home. No answer at the Hocking residence. Will try later. M.J. Bushman

Depending on how much trouble Joe Jr. has been into in the recent past determines whether he is at home or at an alternate address [redacted] Camp River Sight Rd., Hingham

1530hrs Phone call returned to MTSO by Todd. He sold the truck to Hocking in March 1998. The vehicle has a 4 inch lift kit with large 12.5 inch wide tires x33 on 16.5 rims BF Goodrich all terrain tires. They are allterrain not mud and not street-in between. They were in poor condition when sold. Todd saw the truck today. It is still very tall and the new tires are similar tall and wide. Todd did not notice damage to the grill, he saw the vehicle from behind. Vehicle was lifted since Todd bought it 4-5 years ago.

1730hrs Attempted contact by phone with Joe Hocking Sr., not home until 1830hrs. M.J. Bushman

03/13/99 0900hrs Attempted 4 calls between 0900-1000hrs, line busy. M.J. Bushman

03/13/99 1100hrs not available, 1512hrs busy signal. M.J. Bushman

03/20/99 0909hrs Contact by phone made with Joseph W. Hocking Senior. His son was working in Manitowoc about the time of the accident for RBA and when he quit moved to Stack N Store also in the Manitowoc area. He is currently working for his Joseph W. Hockings Senior's business. There is damage to the bumper of his son's truck from hooking a yellow pole at the Super America station in Manitowoc. The truck is very high and when his son drove forward he hooked the pole. He backed up bending the bumper and frame. The grill is fully intact only covered with cardboard for the winter. Hockings is very cooperative inviting Police to view the vehicle if they wish as it is at his residence today, his son is normally very hard to find.

The explanation given and the description do not match the suspect vehicle. Close out. M.J. Bushman

S99 No 02046

45. IF COMPLAINANT DIFFERENT THEN CALLER, ENTER NAME, ADDRESS, D.O.B., TELEPHONE.

46. IF CODE O (OTHER) IS USED IN FIELD #39, EXPLAIN.

INCIDENT REPORT: NOTE: IF SECTION 22 ABOVE HAS NUMBER 4 CHECKED, DO NOT GO BEYOND THIS LINE WITHOUT RECORDS SECTION BEING ADVISED, OR NO RECORD ENTRIES WILL BE MADE BELOW THIS LINE.

PROPERTY VALUE	26. PROPERTY	A. CURRENCY	B. JEWELRY	C. FURS CLOTHING	D. VEHICLE (LOCAL)	E. OFFICE EQUIPMENT	F. RADIO, TV CAMERAS	G. FIREARMS	H. HOUSE-HOLD GOODS
	STOLEN	\$	\$	\$	\$	\$	\$	\$	\$
	RECOVERED	\$	\$	\$	\$	\$	\$	\$	\$
	26. PROPERTY	I. CONSUMABLES	J. LIVESTOCK	K. DRUGS	L. MARINE ITEMS	M. CONSTRUCTION ITEMS	N. LAWN AND GARDEN	O. SPORTING GOODS	P. MISC BICYCLE
	STOLEN	\$	\$	\$	\$	\$	\$	\$	\$
	RECOVERED	\$	\$	\$	\$	\$	\$	\$	\$

27. PROPERTY RECOVERED: LOCALLY _____ OTHER JURISDICTION _____ (INSERT O OR L)

PROPERTY ITEMIZATION	PROPERTY STOLEN/RECOVERED ITEMIZATION, USE THE FOLLOWING FORMAT				31. SERIAL NUMBER	32. CODE		
	28. QUANTITY	29. ARTICLE NAME	30. BRAND NAME					
							S <input type="checkbox"/>	R <input type="checkbox"/>
							S <input type="checkbox"/>	R <input type="checkbox"/>
							S <input type="checkbox"/>	R <input type="checkbox"/>
							S <input type="checkbox"/>	R <input type="checkbox"/>
							S <input type="checkbox"/>	R <input type="checkbox"/>

33. PROPERTY DAMAGE AMOUNT \$ _____

34. INSURANCE COMPANY _____

35. OFFICER ASSAULTED Y N

36. ARSON Y N

37. STRUCTURE CODE _____ 38. DAMAGE \$ _____

47. CIB ENTERED CANCELLED
 NCIC
 OTHER BROADCAST

48. TOTAL AMOUNT PROPERTY STOLEN \$ _____

49. TOTAL AMOUNT PROPERTY RECOVERED \$ _____

50. IS REPORT CONTINUED? YES NO

51. CAUTION INDICATORS, ATLS ETC.

52. DATA PROCESS INFORMATION:

COMPUTER ENTERED DATE 10/31/99
 MICROFILM INDEXED INITIAL KS

IS CASE CLASSIFICATION CORRECT? Y N
 IF N HAS CORRECTION BEEN MADE? Y N

53. FILE APPROVAL

BY OK

DATE 10/30/99

MASTER NAME FILE

NUMBER 0041183

BUSINESS

NAME (L) HOCKING (F) JOSEPH (MI) W

STREET RT 1

CITY WALDO STATE WI ZIP 53093

DOB [REDACTED] A/J A

SEX M RACE ETHN PHONE [REDACTED] SS NO 000000000

DL # 00000000000000 00

HGHT 000 WGHT 000 HAIR EYES CAUTION

CMD 6-PHY DESC F^{AMS}

1400
145R Has

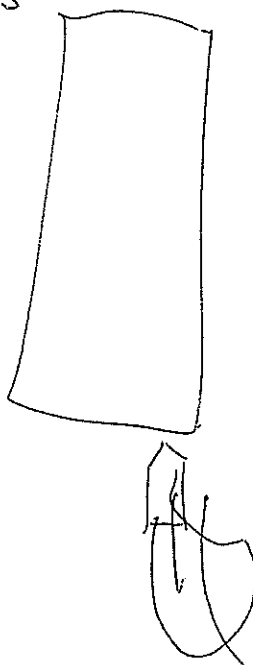

1. CASE # S99 02060 2. CLASSIFICATION 1630.15 3. CENSUS 21000

4. INCIDENT # S99-00242

5. INCIDENT LOCATION

6. NAME- LAST-FIRST-MI ANCHOR MOUNT 7. D.O.B.

8. ADDRESS 9. TX-HOME

11. CITY STATE ZIP 10. TX-BUSINESS

12. DETAILS
 COMPT. REPORTS A FRANCIS
 KOSOBUCKI STOPPED DRIVING AN
 85 CHEV. 4WD AROUND TIME OF
 ACCIDENT

1700HRS 3/12
 0930HRS 3/13

MANITOWOC COUNTY SHERIFF
 INCIDENT CARD

18. ASSIGNED
 M. J. BUSHMAN 4/41
 T.R.V.A. 9/39
 9/39

19. REC'D BY MJB 20. DIS. BY MJB
 22. TYPE OF REPORT
 1. INCIDENT
 2. ACCIDENT
 3. CITATION
 4. NONE

21. HOW REC'D.
 1. 911
 2. POLICE RADIO
 3. PHONE
 4. CITY
 5. IN PERSON
 6. ON VIEW
 7. OFF. OFF DUTY
 8. C.B. RADIO
 9. OTHER

23. STATUS
 1. UNFOUNDED
 2. PNL
 3. OTHER
 4. CLEARED
 5. EXCEPT CLEARED
 24. DATE CLEARED 03/16/99
 25. OFFENSE TYPE
 1. ADULT NA
 2. JUVENILE
 3. UNKNOWN

14. REC'D 15. DISP 16. 10-23 17. 10-24
 13. DAY
 SUN 1 THU 5
 MON 2 FRI 6
 TUE 3 SAT 7
 WED 4

39. (CODE S-SUSPECT W-WITNESS V-VICTIM O-OTHER)	40. NAME-LAST	FIRST	MI	41. D.O.B.	42. ADDRESS	43. TELEPHONE
O	KOSOBUCKI	FRANCIS A SR			18TH ST. TWO RIVERS	
O	KOSOBUCKI	FRANCIS A. JR			18TH ST. TWO RIVERS	
		123347				

03/13/99 0930hrs I, Lt. Bushman took the Crimestopper information at the front jail lobby, 03/12/99 1700hrs.
 Lt. Mohr from Two Rivers PD is the shift commander saturday morning and his assistance with followup was requested. He advised they check the Kosobucki family this morning and if not completed pass information to Lt. Sheahan who comes in at noon. M.J. Bushman
 03/13/99 1300hrs Officer Christianson TRPD did the followup and met with Kosobucki. Vehicle in question is a late 70's GMC red 4WD very high off the ground. This would be the only older vehicle he owns, no other vehicles in storage. Two Rivers report attached, no further followup, close out. M.J. Bushman

45. IF COMPLAINANT DIFFERENT THEN CALLER, ENTER NAME, ADDRESS, D.O.B., TELEPHONE.

46. IF CODE O (OTHER) IS USED IN FIELD #39, EXPLAIN.

INCIDENT REPORT: NOTE: IF SECTION 22 ABOVE HAS NUMBER 4 CHECKED, DO NOT GO BEYOND THIS LINE WITHOUT RECORDS SECTION BEING ADVISED, OR NO RECORD ENTRIES WILL BE MADE BELOW THIS LINE.

PROPERTY VALUE	26. PROPERTY	A. CURRENCY	B. JEWELRY	C. FURS CLOTHING	D. VEHICLE (LOCAL)	E. OFFICE EQUIPMENT	F. RADIO, TV CAMERAS	G. FIREARMS	H. HOUSE-HOLD GOODS
	STOLEN	\$	\$	\$	\$	\$	\$	\$	\$
	RECOVERED	\$	\$	\$	\$	\$	\$	\$	\$
	26. PROPERTY	I. CONSUM-ABLES	J. LIVESTOCK	K. DRUGS	L. MARINE ITEMS	M. CONSTRUCTION ITEMS	N. LAWN AND GARDEN	O. SPORTING GOODS	P. MISC BICYCLE
	STOLEN	\$	\$	\$	\$	\$	\$	\$	\$
	RECOVERED	\$	\$	\$	\$	\$	\$	\$	\$

27. PROPERTY RECOVERED: LOCALLY _____ OTHER JURISDICTION _____ (INSERT O OR L)

PROPERTY ITEMIZATION	PROPERTY STOLEN/RECOVERED ITEMIZATION, USE THE FOLLOWING FORMAT				
	28. QUANTITY	29. ARTICLE NAME	30. BRAND NAME	31. SERIAL NUMBER	32. CODE
					S R <input type="checkbox"/> <input type="checkbox"/>
					S R <input type="checkbox"/> <input type="checkbox"/>
					S R <input type="checkbox"/> <input type="checkbox"/>
					S R <input type="checkbox"/> <input type="checkbox"/>
					S R <input type="checkbox"/> <input type="checkbox"/>

33. PROPERTY DAMAGE AMOUNT \$ _____

34. INSURANCE COMPANY _____

35. OFFICER ASSAULTED Y N

36. ARSON Y N

37. STRUCTURE CODE _____

38. DAMAGE \$ _____

47. CIB

ENTERED

CANCELLED

NCIC

OTHER BROADCAST

48. TOTAL AMOUNT PROPERTY STOLEN \$ _____

49. TOTAL AMOUNT PROPERTY RECOVERED \$ _____

50. IS REPORT CONTINUED? YES NO

51. CAUTION INDICATORS, ATLS ETC.

52. DATA PROCESS INFORMATION:

COMPUTER ENTERED DATE 3/16/99

MICROFILM INDEXED INITIAL AS

IS CASE CLASSIFICATION CORRECT?
IF N HAS CORRECTION BEEN MADE?

Y N
 N

53. FILE APPROVAL

BY [Signature]

DATE 03/16/99

FAX TRANSMISSION



TWO RIVERS POLICE DEPARTMENT

[REDACTED] East Park Street

Two Rivers, WI. 54241

Telephone: [REDACTED]

Fax: [REDACTED]

To: Lt. Bushman

Date: March 13, 1999

Fax #: PSJS

Pages: 4, including this cover sheet.

From: Gary P. Sheahan

Subject: Follow up on Hit & Run Vehicle

COMMENTS:

This message is intended only for the use of the individual or entity to which it is addressed and may contain information that is privileged, confidential, and exempt from disclosure under applicable law. If the reader of this message is not the intended recipient or the employee or agent responsible for delivering the message to the intended recipient, you are hereby notified that any dissemination, distribution, or copying of this communication is strictly prohibited. If you have received this communication in error, please notify us immediately by telephone and return the original message to us at the above address via the U.S. Postal Service. Thank you.

TWO RIVERS POLICE DEPARTMENT CASE NOTES

ENTERED

OFFICER: Christiansen

INCIDENT # _____

TIME REPORTED: _____

TIME ASSIGNED: _____

(F10) SUBJECTS

CODE: A=Arrested C=Complainant I=Informational JP=Juvenile Parent M=Missing Person S=Suspect V=Victim W=Witness

CODE	NAME (last,first,middle)	ADDRESS	CITY/STATE/ZIP	TELEPHONE
I	Kosabucki Francis A Sr	[REDACTED]	186	[REDACTED]
	DOB	RACE/SEX	HEIGHT/WEIGHT	HAIR/EYES
			DL NUMBER	OTHER ID

CODE	NAME (last,first,middle)	ADDRESS	CITY/STATE/ZIP	TELEPHONE
	w/m			
	DOB	RACE/SEX	HEIGHT/WEIGHT	HAIR/EYES
			DL NUMBER	OTHER ID

CODE	NAME (last,first,middle)	ADDRESS	CITY/STATE/ZIP	TELEPHONE
	DOB	RACE/SEX	HEIGHT/WEIGHT	HAIR/EYES
			DL NUMBER	OTHER ID

CODE	NAME (last,first,middle)	ADDRESS	CITY/STATE/ZIP	TELEPHONE
	DOB	RACE/SEX	HEIGHT/WEIGHT	HAIR/EYES
			DL NUMBER	OTHER ID

CODE	NAME (last,first,middle)	ADDRESS	CITY/STATE/ZIP	TELEPHONE
	DOB	RACE/SEX	HEIGHT/WEIGHT	HAIR/EYES
			DL NUMBER	OTHER ID

CODE	NAME (last,first,middle)	ADDRESS	CITY/STATE/ZIP	TELEPHONE
	DOB	RACE/SEX	HEIGHT/WEIGHT	HAIR/EYES
			DL NUMBER	OTHER ID

(F24) NARRATIVE

Requested by Lt. Bushman to check on vehicle owned by Kosabucki re: hit-and-run fatality. Vehicle was late 70's GMC red 4-wheel drive very high off the ground. Only older vehicle he owns - no other vehicles in storage anywhere

3-13-99 09:35

Lt. Mike Bushman

[redacted] - [redacted]

Frances
Kosobucki 46 yrs

+ Jr. 19 yrs

85 yr. Truck

79 Chev Blazer

GMC
GMC

(in storage
on CTH @

[redacted] April
Michigan

Red @ 4 wheel Dr.

GMC
backyard
older

Anon. Compl.

Jar. got a d. st.
truck

4-19-58

Francis A.

Rosobucki Sr.

[REDACTED] 18th St

[REDACTED] - [REDACTED]

1. CASE # S99 No 02062 2. CLASSIFICATION 6310.11.70000 3. CENSUS

4. INCIDENT CS 599-00242

5. INCIDENT LOCATION

6. LAST-FIRST-MI LAST FIRST MI 7. D.O.B.

8. ADDRESS 9. TX-HOME

11. CITY STATE ZIP 10. TX-BUSINESS

12. DETAILS

received by from CASO

re: possible suspect

veh # AG 51856

3/13/99 0940

14. REC'D 15. DISP 16. 10-23 17. 10-24
 13. DAY
 SUN 1 THU 5
 MON 2 FRI 6
 TUE 3 SAT 7
 WED 4

MANITOWOC COUNTY SHERIFF INCIDENT CARD

18. ASSIGNED Bushman 441
 MTSO 929

19. REC. BY 921 20. DIS. BY
 22. TYPE OF REPORT
 1. INCIDENT
 2. ACCIDENT
 3. CITATION
 4. NONE

21. HOW REC'D.
 1. 911
 2. POLICE RADIO
 3. PHONE
 4. DTY
 5. IN PERSON
 6. ON VIEW
 7. OFF. OFF DUTY
 8. C.B. RADIO
 9. OTHER
 23. STATUS
 1. UNFOUNDED
 2. PNL
 3. OTHER
 4. CLEARED
 5. EXCEPT CLEARED

24. DATE CLEARED 03/30/99
 25. OFFENSE TYPE
 1. ADULT NA
 2. JUVENILE
 3. UNKNOWN

39. (CODE S-SUSPECT W-WITNESS V-VICTIM O-OTHER)					
CODE	40. NAME-LAST	FIRST MI	41. D.O.B.	42. ADDRESS	43. TELEPHONE
0	Hintz, Greg C.	176535		Hickory Lane, New Holstein	
	New Holstein PD				

03/13/99 1100hrs Contact by phone made with New Holstein PD reference followup on the above listed owner's vehicle an 84 Chevrolet truck. The dispatcher advised she knew the vehicle and that the owner is a young couple who bought a refrigerator from her last fall. The vehicle is an old rusty suburban. Chief Meves is working this morning and he will check for damage. M.J. Bushman
 1358hrs recontact made with New Holstein, no one home, vehicle not around, it will be pasted on to the next shift.

03/15/99 1432hrs Contact made with Off. Hedl by phone. The vehicle in question had been checked early in the investigation by Hedl shortly a conversation with Lt. Bushman on another look alike. The vehicle is visible on a regular basis. Damage to grill minimal with a small 3x8 inch pc. missing and no hood damage. No other sheet metal damage noted. This vehicle not the one we're looking for, close out. M.J. Bushman

45. IF COMPLAINANT DIFFERENT THEN CALLER, ENTER NAME, ADDRESS, D.O.B., TELEPHONE.

46. IF CODE O (OTHER) IS USED IN FIELD #39, EXPLAIN.

INCIDENT REPORT: NOTE: IF SECTION 22 ABOVE HAS NUMBER 4 CHECKED, DO NOT GO BEYOND THIS LINE WITHOUT RECORDS SECTION BEING ADVISED, OR NO RECORD ENTRIES WILL BE MADE BELOW THIS LINE.

PROPERTY VALUE	26. PROPERTY	A. CURRENCY	B. JEWELRY	C. FURS CLOTHING	D. VEHICLE (LOCAL)	E. OFFICE EQUIPMENT	F. RADIO, TV CAMERAS	G. FIREARMS	H. HOUSE-HOLD GOODS
	STOLEN	\$	\$	\$	\$	\$	\$	\$	\$
	RECOVERED	\$	\$	\$	\$	\$	\$	\$	\$
	26. PROPERTY	I. CONSUMABLES	J. LIVESTOCK	K. DRUGS	L. MARINE ITEMS	M. CONSTRUCTION ITEMS	N. LAWN AND GARDEN	O. SPORTING GOODS	P. MISC BICYCLE
	STOLEN	\$	\$	\$	\$	\$	\$	\$	\$
	RECOVERED	\$	\$	\$	\$	\$	\$	\$	\$

27. PROPERTY RECOVERED: LOCALLY ____ OTHER JURISDICTION ____ (INSERT O OR L)

PROPERTY ITEMIZATION	PROPERTY STOLEN/RECOVERED ITEMIZATION, USE THE FOLLOWING FORMAT				
	28. QUANTITY	29. ARTICLE NAME	30. BRAND NAME	31. SERIAL NUMBER	
					S <input type="checkbox"/> R <input type="checkbox"/>
					S <input type="checkbox"/> R <input type="checkbox"/>
					S <input type="checkbox"/> R <input type="checkbox"/>
					S <input type="checkbox"/> R <input type="checkbox"/>
					S <input type="checkbox"/> R <input type="checkbox"/>

33. PROPERTY DAMAGE AMOUNT \$ _____ 34. INSURANCE COMPANY _____

35. OFFICER ASSAULTED Y N 36. ARSON Y N 37. STRUCTURE CODE _____ 38. DAMAGE \$ _____

47. CIB ENTERED CANCELLED
 NCIC
 OTHER BROADCAST

48. TOTAL AMOUNT PROPERTY STOLEN \$ _____
 49. TOTAL AMOUNT PROPERTY RECOVERED \$ _____

50. IS REPORT CONTINUED? YES NO

51. CAUTION INDICATORS, ATLS ETC.

52. DATA PROCESS INFORMATION:
 COMPUTER ENTERED DATE 13/31/99
 MICROFILM INDEXED INITIAL *KS*
 IS CASE CLASSIFICATION CORRECT? Y N
 IF N HAS CORRECTION BEEN MADE? Y N

53. FILE APPROVAL
 BY *QK* DATE 03/30/99
 MCSD 028 1/91

1. CASE # S99 No 02063 | 2. CLASSIFICATION 16310.1 | 3. CENSUS 580.00

4. INCIDENT CS S99-00242

5. INCIDENT LOCATION

6. NAME - LAST - FIRST - MI MANITOWOC POLICE DEPT. | 7. D.O.B.

8. ADDRESS | 9. TX-HOME

11. CITY STATE ZIP | 10. TX-BUSINESS

12. DETAILS
 INFORMATION RECEIVED THAT
 DAVID M MEYER IN MIDDLE OF
 DIVORCE HAS BEEN DRINKING
 MAY OWN OLDER CHEV. SUBURBAN

03/13/99 1147

MANITOWOC COUNTY SHERIFF
INCIDENT CARD

18. ASSIGNED Bushman *[Signature]*

19. REC. BY 921 | 20. DIS. BY

21. HOW REC'D.
 1. 911
 2. POLICE RADIO
 3. PHONE
 4. TTY
 5. IN PERSON
 6. ON VIEW
 7. OFF. OFF DUTY
 8. C.B. RADIO
 9. OTHER

22. TYPE OF REPORT
 1. INCIDENT
 2. ACCIDENT
 3. CITATION
 4. NONE

23. STATUS
 1. UNFOUNDED
 2. PNL
 3. OTHER
 4. CLEARED
 5. EXCEPT CLEARED

24. DATE CLEARED 03/16/99

25. OFFENSE TYPE
 1. ADULT NA
 2. JUVENILE
 3. UNKNOWN

14. REC'D	15. DISP	16. 10-23	17. 10-24
13. DAY			
SUN 1	THU 5		
MON 2	FRI 6		
TUE 3	SAT 7		
WED 4			

39. (CODE S-SUSPECT W-WITNESS V-VICTIM O-OTHER)						
CODE	40. NAME-LAST	FIRST	MI	41. D.O.B.	42. ADDRESS	43. TELEPHONE
O	MEYER	DAVID	M		50. 24TH ST. MTWR	

03/13/99 1140hrs Contact made with David M. Meyer at his residence [redacted] So 24th St in the City of Manitowoc. Meyer walked outside with Officer to talk away from his children. He was very soft spoken, calm, cooperative attitude, stating; "We all wish you'd catch him." Meyer stated he knew the Hochstetler family and had last seen them at Christmas when he delivered a Xmas tree to their residence on CTH CR.

Meyer stated he had owned Chev. Suburbans in the past but its been at least 3-4 years since his last one was around for use with his business. He pointed to a red one ton dual rear wheeled 1994 Chev. parked in the driveway stating; "That's my new baby". Meyer told me his other two vehicles an 88 and 89 Chev P/U's are under the roof at his business on Calumet Avenue.

- Meyer's current three vehicle:
- 1989 Chev Truck registration 93870
 - 1988 GMC Truck registration 93870B
 - 1994 Chev Truck registration 93870C

No further followup at this time, Close out. M.J. Bushman *[Signature]*

CASE # S99 No 02063

45. IF COMPLAINANT DIFFERENT THEN CALLER, ENTER NAME, ADDRESS, D.O.B., TELEPHONE.

46. IF CODE O (OTHER) IS USED IN FIELD #39, EXPLAIN.

INCIDENT REPORT: NOTE: IF SECTION 22 ABOVE HAS NUMBER 4 CHECKED, DO NOT GO BEYOND THIS LINE WITH RECORDS SECTION BEING ADVISED, OR NO RECORD ENTRIES WILL BE MADE BELOW

PROPERTY VALUE	26. PROPERTY	A. CURRENCY	B. JEWELRY	C. FURS CLOTHING	D. VEHICLE (LOCAL)	E. OFFICE EQUIPMENT	F. RADIO, TV CAMERAS	G. FIREARMS	H. HOUSE-HOLD GOODS
	STOLEN	\$	\$	\$	\$	\$	\$	\$	\$
	RECOVERED	\$	\$	\$	\$	\$	\$	\$	\$
	26. PROPERTY	I. CONSUM-ABLES	J. LIVESTOCK	K. DRUGS	L. MARINE ITEMS	M. CONSTRUCTION ITEMS	N. LAWN AND GARDEN	O. SPORTING GOODS	P. MISC BICYCLE
STOLEN	\$	\$	\$	\$	\$	\$	\$	\$	
RECOVERED	\$	\$	\$	\$	\$	\$	\$	\$	

27. PROPERTY RECOVERED: LOCALLY _____ OTHER JURISDICTION _____ (INSERT O OR L)

PROPERTY ITEMIZATION	PROPERTY STOLEN/RECOVERED ITEMIZATION, USE THE FOLLOWING FORMAT				
	28. QUANTITY	29. ARTICLE NAME	30. BRAND NAME	31. SERIAL NUMBER	32. CODE
					S R <input type="checkbox"/> <input type="checkbox"/>
					S R <input type="checkbox"/> <input type="checkbox"/>
					S R <input type="checkbox"/> <input type="checkbox"/>
					S R <input type="checkbox"/> <input type="checkbox"/>

33. PROPERTY DAMAGE AMOUNT \$ _____

34. INSURANCE COMPANY _____

35. OFFICER ASSAULTED Y N

36. ARSON Y N

37. STRUCTURE CODE _____

38. DAMAGE \$ _____

47. CIB

ENTERED

CANCELLED

NCIC

OTHER BROADCAST

48. TOTAL AMOUNT PROPERTY STOLEN \$ _____

49. TOTAL AMOUNT PROPERTY RECOVERED \$ _____

50. IS REPORT CONTINUED? YES NO

51. CAUTION INDICATORS, ATLS ETC.

52. DATA PROCESS INFORMATION:

COMPUTER ENTERED DATE 3/16/99

MICROFILM INDEXED INITIAL AS

IS CASE CLASSIFICATION CORRECT?
IF N HAS CORRECTION BEEN MADE?

Y N
 N

53. FILE APPROVAL

BY [Signature]

DATE 03/16/99

MANITOWOC COUNTY SHERIFF'S DEPARTMENT
FOLLOW-UP REPORT

Page: _____

CASE NUMBER: _____ CLASSIFICATION: _____

INCIDENT: Fatal hit and run on CTH CR

DATE AND TIME: 3-10-99 1615

REPORT CONTINUED: I, Lt. Thorrington took a possible lead in the case from Deputy Chief Fran Nellis. He indicated that information received is that a David M. Meyer LKA of [redacted] South 24th, Manitowoc is in the middle of a divorce, has been drinking heavily in the past. Meyer is known to have an older model chev. suburban. The DEputy Chief also thought that his son to be ex wife may have been employed or is employed at Hardees in Manitowoc. 6/29/99

The Deputy Chief feels that this may or should be checked further as to the condition of Meyer's vehicle.

Lt. Thorrington

EXWIFE NAME IS SUE

LK'D COMPUTER NO DAVID MEYER

1 SUE MEYER IN KTEL

VEHICLE
COLLECTION

3/13/99 1140 93870 (99)
3 TRUCKS 93870 HURT W/H.
HAWEN Y HAD (W/H) 93870 D HURT W/H.

3 OR 4 YEARS

V. LEFT SPOKEN, DEON, ANIM APPTURE "WE ALL WERE

YOU & CHECK HIM"

DETECTIVE XMAS

1. CASE # S99 No 02068 2. CLASSIFICATION 63011 3. CENSUS 62000

4. INCIDENT CS S99-00242

5. INCIDENT LOCATION

6. NAME: LAST-FIRST-MI MTFD (FIRE DEPT.) 3563 7. D.O.B.

8. ADDRESS KEVIN 9. TX-HOME

11. CITY STATE ZIP 10. TX-BUSINESS

[REDACTED]

WANTS TO TALK TO 4441 IN

PERSON. MEET ON SUN DAY A.M.

SEE ATTACHMENT

03/13/99 1940

14. REC'D	15. DISP	16. 10-23	17. 10-24
SUN 1	THU 5		
MON 2	FRI 6		
TUE 3	SAT 7		
WED 4			

MANITOWOC COUNTY SHERIFF		INCIDENT CARD	
18. ASSIGNED		4441	
BUSHMAN		929	
MITSO			
19. REC. BY	20. DIS. BY	22. TYPE OF REPORT	
946		<input checked="" type="radio"/> 1. INCIDENT <input type="radio"/> 2. ACCIDENT <input type="radio"/> 3. CITATION <input type="radio"/> 4. NONE	
21. HOW REC'D.		23. STATUS	
<input checked="" type="radio"/> 1. 911 <input type="radio"/> 2. POLICE RADIO <input type="radio"/> 3. PHONE <input type="radio"/> 4. TTY <input type="radio"/> 5. IN PERSON <input type="radio"/> 6. ON VIEW <input type="radio"/> 7. OFF. OFF DUTY <input type="radio"/> 8. C.B. RADIO <input type="radio"/> 9. OTHER		<input type="radio"/> 1. UNFOUNDED <input type="radio"/> 2. PNL <input checked="" type="radio"/> 3. OTHER <input type="radio"/> 4. CLEARED <input type="radio"/> 5. EXCEPT CLEARED	
24. DATE CLEARED		25. OFFENSE TYPE	
03/30/99		<input type="checkbox"/> 1. ADULT <input type="checkbox"/> NA <input type="checkbox"/> <input type="checkbox"/> 2. JUVENILE <input type="checkbox"/> <input type="checkbox"/> 3. UNKNOWN <input type="checkbox"/>	
21A. M.O.			

39. (CODE S-SUSPECT W-WITNESS V-VICTIM O-OTHER)				41. D.O.B.		42. ADDRESS		43. TELEPHONE	
CODE	40. NAME-LAST	FIRST	MI						
O	Burich, Randolph D.					So 17th, Mtwc			

03/16/99 0800hrs Contact made with Complainant at the firestation. Information was that a Randy D. Burich (Phone Book listing) [REDACTED] So 17th St., Manitowoc had been driving an older model Chev Blazer (model, year, color, registration unknown) but has stopped driving it because it was too expensive to buy gas for it. Comp. stated he thought that to be unusual because gas pricing is at an all time low for the past few years.

Rhas indicates Burich owns: 86 Dodge 4dr, 84 Pont. 4dr, 82 Suzi cycle, 86 Dodge truck. Nothing currently registered fitting description of H&R vehicles. M.J. Bushman
 Leg work followup required.

03/16/99 1557hrs Attempted contact at residence, no answer, 86 Dodge 4dr pulled into yard as I was leaving with Burich driving. Interview conducted, he was calm and cooperative. The Dodge truck listed above was in the driveway, was driving 86 Dodge 4dr, 84 Pont was traded off. Burich stated he has never owned a Chev. Blazer, Suburban, or Pickup. Without I witness account of known Blazer complaint is closed. M.J. Bushman

45. IF COMPLAINANT DIFFERENT THEN CALLER, ENTER NAME, ADDRESS, D.O.B., TELEPHONE.

46. IF CODE O (OTHER) IS USED IN FIELD #39, EXPLAIN.

INCIDENT REPORT: NOTE: IF SECTION 22 ABOVE HAS NUMBER 4 CHECKED, DO NOT GO BEYOND THIS LINE WITHOUT RECORDS SECTION BEING ADVISED; OR NO RECORD ENTRIES WILL BE MADE BELOW THIS LINE.

PROPERTY VALUE	26. PROPERTY	A. CURRENCY	B. JEWELRY	C. FURS CLOTHING	D. VEHICLE (LOCAL)	E. OFFICE EQUIPMENT	F. RADIO, TV CAMERAS	G. FIREARMS	H. HOUSE-HOLD GOODS
	STOLEN	\$	\$	\$	\$	\$	\$	\$	\$
	RECOVERED	\$	\$	\$	\$	\$	\$	\$	\$
	26. PROPERTY	I. CONSUMABLES	J. LIVESTOCK	K. DRUGS	L. MARINE ITEMS	M. CONSTRUCTION ITEMS	N. LAWN AND GARDEN	O. SPORTING GOODS	P. MISC BICYCLE
	STOLEN	\$	\$	\$	\$	\$	\$	\$	\$
	RECOVERED	\$	\$	\$	\$	\$	\$	\$	\$

27. PROPERTY RECOVERED: LOCALLY _____ OTHER JURISDICTION _____ (INSERT O OR L)

PROPERTY ITEMIZATION	PROPERTY STOLEN/RECOVERED ITEMIZATION, USE THE FOLLOWING FORMAT				
	28. QUANTITY	29. ARTICLE NAME	30. BRAND NAME	31. SERIAL NUMBER	32. CODE
					S R <input type="checkbox"/> <input type="checkbox"/>
					S R <input type="checkbox"/> <input type="checkbox"/>
					S R <input type="checkbox"/> <input type="checkbox"/>
					S R <input type="checkbox"/> <input type="checkbox"/>

33. PROPERTY DAMAGE AMOUNT \$ _____

34. INSURANCE COMPANY _____

35. OFFICER ASSAULTED Y N

36. ARSON Y N

37. STRUCTURE CODE _____ 38. DAMAGE \$ _____

47. CIB ENTERED CANCELLED
 NCIC
 OTHER BROADCAST

48. TOTAL AMOUNT PROPERTY STOLEN \$ _____

49. TOTAL AMOUNT PROPERTY RECOVERED \$ _____

50. IS REPORT CONTINUED? YES NO

51. CAUTION INDICATORS, ATLS ETC.

52. DATA PROCESS INFORMATION:

COMPUTER ENTERED DATE 3/31/99
 MICROFILM INDEXED INITIAL KS

53. FILE APPROVAL

IS CASE CLASSIFICATION CORRECT?
 IF N HAS CORRECTION BEEN MADE?

Y N

BY [Signature]

DATE 03/30/99

IMPORTANT MESSAGE

SPDR Lt. BUSHMAN / 441
DATE 03/15 TIME 1543 AM P.M.
M [REDACTED] - Mtwe
OF [REDACTED]
PHONE [REDACTED]
AREA CODE NUMBER EXTENSION
 FAX
 MOBILE
AREA CODE NUMBER TIME TO CALL

TELEPHONED	<input checked="" type="checkbox"/>	PLEASE CALL	<input checked="" type="checkbox"/>
CAME TO SEE YOU	<input type="checkbox"/>	WILL CALL AGAIN	<input type="checkbox"/>
WANTS TO SEE YOU	<input type="checkbox"/>	RUSH	<input type="checkbox"/>
RETURNED YOUR CALL	<input type="checkbox"/>	SPECIAL ATTENTION	<input type="checkbox"/>

MESSAGE
MIKE PLEASE CALL
TOMORROW. 03/16.
[REDACTED]
[REDACTED]
[REDACTED]
SIGNED Kara 938

1. CASE # S99 No 02105
 2. CLASSIFICATION 6,3|0,1|
 3. CENSUS 0,3|Q 2,8

MANITOWOC COUNTY SHERIFF
 INCIDENT CARD

4. INCIDENT CS/S99-00242

18. ASSIGNED MTSO 9 | 2 | 19

5. INCIDENT LOCATION
 Hidden Valley Rd Maribel

NAME - LAST - FIRST - MI BRSO 7. D.O.B.

8. ADDRESS 9. TX-HOME

11. STATE ZIP 10. TX-BUSINESS

19. REC. BY 20. DIS. BY 22. TYPE OF REPORT
 923
 1. INCIDENT
 2. ACCIDENT
 3. CITATION
 4. NONE

12. DETAILS
 TTY message stating possibly our hit & run

vehicle is parked in the garage at Hidden Valley Rd at Albert Holt residence.

See TTY message for more details.

03/15/99 1311

14. REC'D	15. DISP	16. 10-23	17. 10-24
13. DAY			
SUN 1	THU 5		
MON 2	FRI 6		
TUE 3	SAT 7		
WED 4			

21. HOW REC'D.
 1. 911
 2. POLICE RADIO
 3. PHONE
 4. TTY
 5. IN PERSON
 6. ON VIEW
 7. OFF. OFF DUTY
 8. C.B. RADIO
 9. OTHER

23. STATUS
 1. UNFOUNDED
 2. PNL
 3. OTHER
 4. CLEARED
 5. EXCEPT CLEARED

24. DATE CLEARED 03/12/99

21A. M.O.
 25. OFFENSE TYPE
 1. ADULT NA
 2. JUVENILE
 3. UNKNOWN

39. (CODE S-SUSPECT W-WITNESS V-VICTIM O-OTHER)						
CODE	40. NAME-LAST	FIRST	MI	41. D.O.B.	42. ADDRESS	43. TELEPHONE
O	HOLT	ALBERT	W		Hidden Valley Rd, Maribel	

03/16/99 @ 0900 Hrs.: I, Deputy E. Glaeser, made contact at the ALBERT HOLT residence at Hidden Valley Rd, Maribel, reference this complaint. ALBERT HOLT was advised I was presently working on follow-up in regard to the hit and run accident from January 1999. I asked HOLT if he had a problem with me checking his buildings for any possible vehicles that match the suspect guidelines. HOLT was very cooperative. He allowed me access to his garage area. He directed me to 2 other vehicles which were outside his residence.

The vehicle parked inside HOLT'S garage was a 1982 GMC Sierra, blue in color, displaying WI RP HLY300. A 10-28 was run on this RP. It indicated HOLT was the owner. This vehicle did not have any damage on it, neither did the front end match our hit and run guidelines.

The other 2 vehicles present at the residence were also check.

The first was a 1983 Chevy Scottsdale, blue in color, with WI RP TUE746.

The second was a black and gray 1985 Chevy Silverado displaying WI RP BJ94029.

All vehicles were checked over. They can all be eliminated. It should be noted HOLT was very cooperative, and he did offer MTSO any assistance we would need in our investigation of the hit and run incident.

Information on HOLT and the 3 vehicles which are present at his property were entered into the FBI main program. No further action taken. EJGlaeser /bjc

[Handwritten signature]

S99 No 02105

45. IF COMPLAINANT DIFFERENT THEN CALLER, ENTER NAME, ADDRESS, D.O.B., TELEPHONE.

46. IF CODE O (OTHER) IS USED IN FIELD #39, EXPLAIN.

INCIDENT REPORT: NOTE: IF SECTION 22 ABOVE HAS NUMBER 4 CHECKED, DO NOT GO BEYOND THIS LINE WITHOUT RECORDS SECTION BEING ADVISED, OR NO RECORD ENTRIES WILL BE MADE BELOW THIS LINE.

PROPERTY VALUE	26. PROPERTY	A. CURRENCY	B. JEWELRY	C. FURS CLOTHING	D. VEHICLE (LOCAL)	E. OFFICE EQUIPMENT	F. RADIO, TV CAMERAS	G. FIREARMS	H. HOUSE-HOLD GOODS
	STOLEN	\$	\$	\$	\$	\$	\$	\$	\$
	RECOVERED	\$	\$	\$	\$	\$	\$	\$	\$
	26. PROPERTY	I. CONSUMABLES	J. LIVESTOCK	K. DRUGS	L. MARINE ITEMS	M. CONSTRUCTION ITEMS	N. LAWN AND GARDEN	O. SPORTING GOODS	P. MISC BICYCLE
	STOLEN	\$	\$	\$	\$	\$	\$	\$	\$
	RECOVERED	\$	\$	\$	\$	\$	\$	\$	\$

27. PROPERTY RECOVERED: LOCALLY _____ OTHER JURISDICTION _____ (INSERT O OR L)

PROPERTY ITEMIZATION	PROPERTY STOLEN/RECOVERED ITEMIZATION, USE THE FOLLOWING FORMAT			
	28. QUANTITY	29. ARTICLE NAME	30. BRAND NAME	31. SERIAL NUMBER
				S R <input type="checkbox"/> <input type="checkbox"/>
				S R <input type="checkbox"/> <input type="checkbox"/>
				S R <input type="checkbox"/> <input type="checkbox"/>
				S R <input type="checkbox"/> <input type="checkbox"/>
				S R <input type="checkbox"/> <input type="checkbox"/>
				S R <input type="checkbox"/> <input type="checkbox"/>

33. PROPERTY DAMAGE AMOUNT \$ _____

34. INSURANCE COMPANY _____

35. OFFICER ASSAULTED Y N

36. ARSON Y N

37. STRUCTURE CODE _____

38. DAMAGE \$ _____

47. CIB ENTERED CANCELLED
 NCIC
 OTHER BROADCAST

48. TOTAL AMOUNT PROPERTY STOLEN \$ _____

49. TOTAL AMOUNT PROPERTY RECOVERED \$ _____

50. IS REPORT CONTINUED? YES NO

51. CAUTION INDICATORS, ATLS ETC.

52. DATA PROCESS INFORMATION:

COMPUTER ENTERED DATE 16 09 99
 MICROFILM INDEXED INITIAL AS

IS CASE CLASSIFICATION CORRECT?
 IF N HAS CORRECTION BEEN MADE?

Y N
 N

53. FILE APPROVAL

BY [Signature]

DATE 032297

1. CASE # S99 No 02109 6,310.11 5,210.00

INCIDENT CS / 899-00242

5. INCIDENT LOCATION 7 + Viebahn

6. NAME - LAST - FIRST - MI 7. D.O.B. Anonymous

8. ADDRESS 9. TX-HOME

11. CITY STATE ZIP 10. TX-BUSINESS

12. DETAILS
Caller saw a vehicle at 30th + Viebahn that might have been H+R vehicle

1445
3-15-99

MANTOWOC COUNTY SHERIFF INCIDENT CARD

18. ASSIGNED
Lt. Bushman 441
Jost 449
MISO 9129

19. REC. BY 941 20. DIS. BY 941
22. TYPE OF REPORT
1. INCIDENT
2. ACCIDENT
3. CITATION
4. NONE

21. HOW REC'D.
1. 911
2. POLICE RADIO
3. PHONE
4. TTY
5. IN PERSON
6. ON VIEW
7. OFF. OFF DUTY
8. C.B. RADIO
9. OTHER
23. STATUS
1. UNFOUNDED
2. PNL
3. OTHER
4. CLEARED
5. EXCEPT CLEARED

24. DATE CLEARED 03/30/99
25. OFFENSE TYPE
1. ADULT NA
2. JUVENILE
3. UNKNOWN

39. (CODE S-SUSPECT W-WITNESS V-VICTIM O-OTHER)						
CODE	40. NAME-LAST	FIRST	MI	41. D.O.B.	42. ADDRESS	43. TELEPHONE

03/16/99 1023hrs No call back number, no registration, area checked several times after report received, unable to locate, close out in several days if continued unable to locate.
03-19-99 I, Deputy Jost, checked this area twice throughout the day, no find on this vehicle. M.J. Bushman
Close Out. M.J. Bushman

11/10/99
 11/10/99
 11/10/99
 11/10/99

45. IF COMPLAINANT DIFFERENT THEN CALLER, ENTER NAME, ADDRESS, D.O.B., TELEPHONE.

46. IF CODE O (OTHER) IS USED IN FIELD #39, EXPLAIN.

INCIDENT REPORT: NOTE: IF SECTION 22 ABOVE HAS NUMBER 4 CHECKED, DO NOT GO BEYOND THIS LINE WITHOUT RECORDS SECTION BEING ADVISED, OR NO RECORD ENTRIES WILL BE MADE BELOW THIS LINE.

PROPERTY VALUE	26. PROPERTY	A. CURRENCY	B. JEWELRY	C. FURS CLOTHING	D. VEHICLE (LOCAL)	E. OFFICE EQUIPMENT	F. RADIO, TV CAMERAS	G. FIREARMS	H. HOUSEHOLD GOODS
	STOLEN	\$	\$	\$	\$	\$	\$	\$	\$
	RECOVERED	\$	\$	\$	\$	\$	\$	\$	\$
	26. PROPERTY	I. CONSUMABLES	J. LIVESTOCK	K. DRUGS	L. MARINE ITEMS	M. CONSTRUCTION ITEMS	N. LAWN AND GARDEN	O. SPORTING GOODS	P. MISC BICYCLE
STOLEN	\$	\$	\$	\$	\$	\$	\$	\$	
RECOVERED	\$	\$	\$	\$	\$	\$	\$	\$	

27. PROPERTY RECOVERED: LOCALLY _____ OTHER JURISDICTION _____ (INSERT O OR L)

PROPERTY ITEMIZATION	PROPERTY STOLEN/RECOVERED ITEMIZATION, USE THE FOLLOWING FORMAT				
	28. QUANTITY	29. ARTICLE NAME	30. BRAND NAME	31. SERIAL NUMBER	32. CODE
					S R <input type="checkbox"/> <input type="checkbox"/>
					S R <input type="checkbox"/> <input type="checkbox"/>
					S R <input type="checkbox"/> <input type="checkbox"/>
					S R <input type="checkbox"/> <input type="checkbox"/>

33. PROPERTY DAMAGE AMOUNT \$ _____

34. INSURANCE COMPANY _____

35. OFFICER ASSAULTED Y N

36. ARSON Y N

37. STRUCTURE CODE _____

38. DAMAGE \$ _____

47. CIB ENTERED CANCELLED
 NCIC
 OTHER BROADCAST

48. TOTAL AMOUNT PROPERTY STOLEN \$ _____

49. TOTAL AMOUNT PROPERTY RECOVERED \$ _____

50. IS REPORT CONTINUED? YES NO

51. CAUTION INDICATORS, ATLS ETC.

52. DATA PROCESS INFORMATION:

COMPUTER ENTERED DATE 3/31/99
 MICROFILM INDEXED INITIAL KS

53. FILE APPROVAL

IS CASE CLASSIFICATION CORRECT? N
 IF N HAS CORRECTION BEEN MADE? N

BY _____ DATE _____

1. CASE # S99 No 02110	2. CLASSIFICATION 6,310,11	3. CENSUS 1,310,09
4. INCIDENT AS / S99-00242		
5. INCIDENT LOCATION Steiners Cr. Rd.		
6. NAME - LAST - FIRST - MI Anony.	7. D.O.B.	
8. ADDRESS	9. TX-HOME	
11. CITY STATE ZIP	10. TX-BUSINESS	
12. DETAILS See Attached.		

MANITOWOC COUNTY SHERIFF INCIDENT CARD			
18. ASSIGNED MITSO 9/219 Klaeser 4/17			
19. REC. BY 938	20. DIS. BY	22. TYPE OF REPORT ① INCIDENT 2. ACCIDENT 3. CITATION 4. NONE	
21. HOW REC'D. 1. 911 2. POLICE RADIO 3. PHONE 4. TTY 5. IN PERSON 6. ON VIEW 7. OFF. OFF DUTY 8. C.B. RADIO 9. OTHER		23. STATUS 1. UNFOUNDED 2. PNL 3. OTHER 4. CLEARED 5. EXCEPT CLEARED	
13. DAY SUN 1 THU 5 MON 2 FRI 6 TUE 3 SAT 7 WED 4		24. DATE CLEARED 03/30/99	
21A. M.O.		25. OFFENSE TYPE 1. ADULT <input type="checkbox"/> NA <input type="checkbox"/> 2. JUVENILE <input type="checkbox"/> 3. UNKNOWN <input type="checkbox"/>	

39. (CODE S-SUSPECT W-WITNESS V-VICTIM O-OTHER)						
CODE	40. NAME - LAST	FIRST	MI	41. D.O.B.	42. ADDRESS	43. TELEPHONE
O	MCGLIN	PAUL	F		Steiners Dr, Two Rivers	
O	COUNARD	KEITH JR (aka CASEY)			N 43rd St, Manitowoc	

03/16/99: I, Deputy E. Glaeser, started work on this Crime Stopper report. Information was that PAUL MCGLIN used to have a 1984-1985 C5 Blazer with a plow and that he recently sold the vehicle within the last month or so. The anonymous caller stated they were unaware of any damage which the vehicle would have, but they thought it was suspicious that MCGLIN would have sold the vehicle. A description of the vehicle was blue and white.

03/16/99 @ 0620 Hrs.: I attempted contact with MCGLIN at Steiners Dr, Two Rivers, but was unsuccessful in contacting him.

03/16/99 @ 0830 Hrs.: I again attempted contact with MCGLIN and spoke to him at his residence. MCGLIN was advised of this complaint. He was asked if he recently sold a vehicle matching the description given in this complaint. MCGLIN stated he recently sold a 1984 GMC Jimmy to CASEY COUNARD who lives in the City of Manitowoc. MCGLIN was very cooperative. He provided a telephone number for COUNARD. He stated I could contact him to verify the information. MCGLIN also stated the vehicle had no front end damage to it all. Again, he stated it was a 1984 GMC Jimmy.

03/16/99 @ 0845 Hrs.: Attempt was made to contact CASEY COUNARD by telephone, but I met with negative results in reaching him.

03/17/99 @ 0635 Hrs.: I attempted contacted with KEITH COUNARD by telephone. I was advised by his brother to contact him on tomorrow's date before 0600 hours.

03/18/99 @ 0545 Hrs.: I made contact with KEITH COUNARD reference this incident. COUNARD told me his nickname is CASEY, but his real name is KEITH. He acknowledged that he recently purchased a 1984 GMC Jimmy from PAUL MCGLIN. COUNARD supplied the RP of TWR839. Upon running this RP, it comes back on a 1984 GMC truck. COUNARD described the truck as an S15 Jimmy. COUNARD further stated the truck had no front end damage on it. He stated he purchased the truck approximately 2 weeks ago (03/01/99 or 03/02/99).

Due to the fact this vehicle does not meet the hit and run parameters, the vehicle can be eliminated. Information on MCGLIN and COUNARD was entered into the main FBI file. No further action taken. EJGlaeser /bjc

S99 No 02110

ACTIVE

45. IF COMPLAINANT DIFFERENT THEN CALLER, ENTER NAME, ADDRESS, D.O.B., TELEPHONE.

46. IF CODE O (OTHER) IS USED IN FIELD #39, EXPLAIN.

INCIDENT REPORT: NOTE: IF SECTION 22 ABOVE HAS NUMBER 4 CHECKED, DO NOT GO BEYOND THIS LINE WITHOUT RECORDS SECTION BEING ADVISED, OR NO RECORD ENTRIES WILL BE MADE BELOW THIS LINE.

PROPERTY VALUE	26. PROPERTY	A. CURRENCY	B. JEWELRY	C. FURS CLOTHING	D. VEHICLE (LOCAL)	E. OFFICE EQUIPMENT	F. RADIO, TV CAMERAS	G. FIREARMS	H. HOUSE-HOLD GOODS
	STOLEN	\$	\$	\$	\$	\$	\$	\$	\$
	RECOVERED	\$	\$	\$	\$	\$	\$	\$	\$
	26. PROPERTY	I. CONSUM-ABLES	J. LIVESTOCK	K. DRUGS	L. MARINE ITEMS	M. CONSTRUCTION ITEMS	N. LAWN AND GARDEN	O. SPORTING GOODS	P. MISC BICYCLE
	STOLEN	\$	\$	\$	\$	\$	\$	\$	\$
	RECOVERED	\$	\$	\$	\$	\$	\$	\$	\$

27. PROPERTY RECOVERED: LOCALLY _____ OTHER JURISDICTION _____ (INSERT O OR L)

PROPERTY ITEMIZATION	PROPERTY STOLEN/RECOVERED ITEMIZATION, USE THE FOLLOWING FORMAT			
	28. QUANTITY	29. ARTICLE NAME	30. BRAND NAME	31. SERIAL NUMBER
				32. CODE S <input type="checkbox"/> R <input type="checkbox"/>
				S <input type="checkbox"/> R <input type="checkbox"/>
				S <input type="checkbox"/> R <input type="checkbox"/>
				S <input type="checkbox"/> R <input type="checkbox"/>
				S <input type="checkbox"/> R <input type="checkbox"/>
				S <input type="checkbox"/> R <input type="checkbox"/>

33. PROPERTY DAMAGE AMOUNT \$ _____ 34. INSURANCE COMPANY _____

35. OFFICER ASSAULTED Y N 36. ARSON Y N 37. STRUCTURE CODE _____ 38. DAMAGE \$ _____

47. CIB	ENTERED <input type="checkbox"/>	CANCELLED <input type="checkbox"/>	48. TOTAL AMOUNT PROPERTY STOLEN \$ _____
NCIC	<input type="checkbox"/>	<input type="checkbox"/>	
OTHER BROADCAST	<input type="checkbox"/>	<input type="checkbox"/>	
			49. TOTAL AMOUNT PROPERTY RECOVERED \$ _____

50. IS REPORT CONTINUED? YES NO 51. CAUTION INDICATORS, ATLS ETC.

52. DATA PROCESS INFORMATION:

COMPUTER ENTERED DATE 133199

MICROFILM INDEXED INITIAL AS

IS CASE CLASSIFICATION CORRECT? IF N HAS CORRECTION BEEN MADE? Y N

53. FILE APPROVAL BY [Signature] DATE 033099

MCSO 028 1/91

1. CASE # S99 No 02118	2. CLASSIFICATION 6.310.11	3. CENSUS 601000
4. INCIDENT CS / S99-00242		
5. INCIDENT LOCATION		
6. NAME - LAST-FIRST-MI ANONY.	7. D.O.B. (2)	
8. ADDRESS		9. TX-HOME
11. CITY	STATE	ZIP
10. TX-BUSINESS		
12. DETAILS See Attached		

MANITOWOC COUNTY SHERIFF INCIDENT CARD			
18. ASSIGNED MTS		91219	
19. REC. BY 438	20. DIS. BY	22. TYPE OF REPORT (1) INCIDENT	
21. HOW REC'D. 1. 911 2. POLICE RADIO (3) PHONE 3. PHONE 4. TTY 5. IN PERSON 6. ON VIEW 7. OFF. OFF DUTY 8. C.B. RADIO 9. OTHER		23. STATUS 1. UNFOUNDED 2. PNL (3) OTHER 3. OTHER 4. CLEARED 5. EXCEPT CLEARED	
13. DAY MON 2		24. DATE CLEARED 10/12/99	
25. OFFENSE TYPE 1. ADULT <input type="checkbox"/> NA <input type="checkbox"/> 2. JUVENILE <input type="checkbox"/> 3. UNKNOWN <input type="checkbox"/>			

1857
03-15-99

39. (CODE S-SUSPECT W-WITNESS V-VICTIM O-OTHER)	40. NAME-LAST	FIRST	MI	41. D.O.B.	42. ADDRESS	43. TELEPHONE
.O	Jones, Matthew R.				Man Cal Rd. Reedsville	
					STH 67, Delavan 53115	
O	JONES	RONALD	R		N Jackson St #35, Valders	
O	JONES	ROBERT	H		N Jackson St #35, Valders	

03/16/99 1400hrs The only vehicle listed to Jones is a cycle and it does not appear to be a match with the correct Jones. Unable to call Complainant Mike, no answer. No answer at the inhouse number for Jones, recording says no longer in service. Foot check required. M.J.Bushman

03/24/99: I, Lt. M. Bushman, made contact with the confidential informant on this Crime Stopper complaint as more information was needed for follow-up. It was learned MATTHEW JONES lived in the Wayside area and then moved to Fond du Lac approximately 6 months ago. Apparently, he was in San Francisco for a short time. The informant stated, the last he heard, he now lives in Lake Geneva. The bank which repossessed the vehicle from MATTHEW is in Fond du Lac, name unknown. It was also learned MATTHEW has parents living in Valders in the trailer court.

Contact was made by phone with Chief Riesterer of Valders PD. He stated there was a RONALD JONES in lot #35 in the trailer court.

03/24/99 @ 2000 Hrs.: Contact was made at lot #35 in the Valders trailer court with the mother of MATTHEW JONES. I was invited in, and we had a conversation at the kitchen table. She stated, on 01/16/99, MATTHEW took off and no one knew his whereabouts. She recalled the day because it happened to be her other son's (ROBERT JONES') birthday, and he was wrestling in a tournament that afternoon. She recalls withholding the information that MATTHEW had left for unknown whereabouts because she did not wish to upset ROBERT until after he competed at the tournament.

The following day (01/17/99), Fond du Lac PD notified the JONES family that MATTHEW'S truck was in a parking lot in their City and they wished to have it removed. ROBERT traveled to Fond du Lac and picked up his brother's 1985 Chevy Blazer.

Also, on 01/17/99, ROBERT was involved in a 2-car accident on CTH W at Manitowoc Rd in the Village of Reedsville with this same vehicle (incident S99-00491). The damage from that

S99 No 02118

45. IF COMPLAINANT DIFFERENT THEN CALLER, ENTER NAME, ADDRESS, D.O.B., TELEPHONE.

46. IF CODE O (OTHER) IS USED IN FIELD #39, EXPLAIN.

INCIDENT REPORT: NOTE: IF SECTION 22 ABOVE HAS NUMBER 4 CHECKED, DO NOT GO BEYOND THIS LINE WITHOUT RECORDS SECTION BEING ADVISED, OR NO RECORD ENTRIES WILL BE MADE BELOW THIS LINE.

PROPERTY VALUE	26. PROPERTY	A. CURRENCY	B. JEWELRY	C. FURS CLOTHING	D. VEHICLE (LOCAL)	E. OFFICE EQUIPMENT	F. RADIO, TV CAMERAS	G. FIREARMS	H. HOUSE-HOLD GOODS
	STOLEN	\$	\$	\$	\$	\$	\$	\$	\$
	RECOVERED	\$	\$	\$	\$	\$	\$	\$	\$
	26. PROPERTY	I. CONSUM-ABLES	J. LIVESTOCK	K. DRUGS	L. MARINE ITEMS	M. CONSTRUCTION ITEMS	N. LAWN AND GARDEN	O. SPORTING GOODS	P. MISC BICYCLE
	STOLEN	\$	\$	\$	\$	\$	\$	\$	\$
	RECOVERED	\$	\$	\$	\$	\$	\$	\$	\$

27. PROPERTY RECOVERED: LOCALLY _____ OTHER JURISDICTION _____ (INSERT O OR L)

PROPERTY ITEMIZATION	PROPERTY STOLEN/RECOVERED ITEMIZATION, USE THE FOLLOWING FORMAT				
	28. QUANTITY	29. ARTICLE NAME	30. BRAND NAME	31. SERIAL NUMBER	32. CODE
					S R <input type="checkbox"/> <input type="checkbox"/>
					S R <input type="checkbox"/> <input type="checkbox"/>
					S R <input type="checkbox"/> <input type="checkbox"/>
					S R <input type="checkbox"/> <input type="checkbox"/>
					S R <input type="checkbox"/> <input type="checkbox"/>

33. PROPERTY DAMAGE AMOUNT \$ _____

34. INSURANCE COMPANY _____

35. OFFICER ASSAULTED Y N

36. ARSON Y N

37. STRUCTURE CODE _____ 38. DAMAGE \$ _____

47. CIB ENTERED CANCELLED
 NCIC
 OTHER BROADCAST

48. TOTAL AMOUNT PROPERTY STOLEN \$ _____

49. TOTAL AMOUNT PROPERTY RECOVERED \$ _____

50. IS REPORT CONTINUED? YES NO

51. CAUTION INDICATORS, ATLS ETC.

52. DATA PROCESS INFORMATION:

COMPUTER ENTERED DATE 16/09/99
 MICROFILM INDEXED INITIAL AS

53. FILE APPROVAL

BY [Signature] DATE 10/12/99

IS CASE CLASSIFICATION CORRECT?
 IF N HAS CORRECTION BEEN MADE? Y N

MANITOWOC COUNTY SHERIFF'S DEPARTMENT
FOLLOW-UP REPORT

Page: 2

CASE NUMBER: 599-02118 CLASSIFICATION: _____

INCIDENT: _____

DATE AND TIME: _____

REPORT CONTINUED:

After approximately 1 week with whereabouts unknown, MATTHEW wired his sister living in the Delavan, WI, area for money. He then returned to her residence. He is currently living with his sister and her family and does have his vehicle.

MATTHEW'S mother explained to me that MATTHEW had been behind in payments of his vehicle; however, arrangements were made with the bank so that he could keep the vehicle at this time. She stated his personal life got out of hand, and there was a break-up with his girlfriend whom he has 2 children with. He needed time alone and then returned and has now sorted out his problems.

MATTHEW works in the Delavan area and is expected home to Valders on the weekend which is his custom to visit his children. His mother had not heard from him to the contrary, and she would expect him to be here.

A card was left with my name and number. I, Lt. Bushman, would like for MATTHEW to contact MTSO and have an officer check his vehicle this weekend.

A copy of the 10-28 for his vehicle and the non-reportable accident report are attached to this complaint. MJBushman /bjc
03/29/99 2109 hrs. There was no note located reference this complaint upon my return to work, apparently Matthew did not call this weekend. M.J.Bushman

Contact made at the Jones residence by phone. I was advised Matthew had called in at the number I provided and some one from the village checked his vehicle. Radio log showed Off. Jim Froelich was out checking vehicles for us and he made contact 1642hrs on Saturday.

Contact by phone made with Froelich. He advised there was a crack in the grille but no other damage to the frontend. There was damage to the left rear which had been noted on the accident report from the Reedsville incident. This is also a newer style Chev. not the design we are looking for, this complaint can be closed. M.J.Bushman

03/27/99: I, Deputy J. B. Froelich, went to the trailer park in Valders to check on a vehicle bearing WI RP AK37064. The owner of the vehicle was MATTHEW JONES who lives out of town at this time but returned to Valders for the weekend. I checked the vehicle in question--a 1985 Chevy Blazer 4-wheel drive. In checking the vehicle, it can be eliminated from the list.

Note: This vehicle was involved in an accident on 01/17/99, and a driver accident report was made out. The damage was to the driver/passenger side of the vehicle. There was minor damage to the vehicle. JBFroelich /bjc

ENTERED etc

WISCONSIN DRIVER REPORT OF ACCIDENT

General Information
Reportable Accident
 NO YES

Run Accident
 NO YES

ACCIDENT LOCATION MANITOWOC MAPLE GRAVE County of _____ City, Village or Township of _____ ACCIDENT DATE 01-17-99 Month 01 Day 17 Year 99 Day of Week SUN Time 1:20 A P

Total Units Involved 2 Total Injured 0

Name and Number of Street(s) or Highway or Parking Lot CTH W AT MANITOWOC RD Phone Number 11-04-0340-084

UNIT 1
Driver Full Name (Last, First, MI) JONES, ROBERT H Sex M
Address N. JACKSON ST 35 Birth Date 10/29/62
City & State VALDERS WI Zip Code 54245 Phone Number () NA
Driver License Number () Issuing State WI

UNIT 2
Driver Full Name (Last, First, MI) BUBOLZ, DANIEL H Sex M
Address MANITOWOC RD Birth Date 10/40/88
City & State REEDSVILLE WI Zip Code 54230 Phone Number ()
Driver License Number () Issuing State WI

Vehicle Legally Parked YES NO
Hit a Deer YES NO
Operating a commercial vehicle? NO YES
If yes, circle appropriate classification: A B C

Vehicle Legally Parked YES NO
Hit a Deer YES NO
Operating a commercial vehicle? NO YES
If yes, circle appropriate classification: A B C

Owner Full Name (Last, First, MI) JONES, MATTHEW R
Address LEDGE RD
City & State MALONE WI Zip Code 53049 Phone Number () NA
License Plate Number AK37064 Exp Yr 99 Issuing State WI Vehicle Make CHEV Year 85 Color BLK
Vehicle Identification Number ()

Owner Full Name (Last, First, MI) OPERATOR
Address ()
City & State () Zip Code () Phone Number ()
License Plate Number LCX-700 Exp Yr 99 Issuing State WI Vehicle Make OLDS Year 92 Color RED
Vehicle Identification Number ()

Was a motor vehicle liability insurance policy in effect on the day of the accident?
 NO YES
Policy Holder's Name ()
Exact Name of Insurance Company NONE

Was a motor vehicle liability insurance policy in effect on the day of the accident?
 NO YES
Policy Holder's Name ()
Exact Name of Insurance Company AMERICAN FAMILY INS

INJURED (If driver, was person injured, write "Operator" instead of Name)							Injury Code A=Severe, B=Moderate, C=Min		
Unit No	Name (Last, First, MI)	Address	City & State	Zip Code	Sex	Date of Birth	Injury Code		

VEHICLE DAMAGE Unit 1 - (Circle numbered areas of vehicle damaged)
Is damage over \$1000? No Yes
If Yes, damage estimate \$ _____
Diagram: 

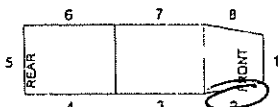
VEHICLE DAMAGE Unit 2 - (Circle numbered areas of vehicle damaged)
Is damage over \$1000? No Yes
If Yes, damage estimate \$ _____
Diagram: 

PROPERTY DAMAGE Describe what was damaged (Do Not include vehicle damage)
Property Owner Full Name (Last, First, MI) _____ Address, City, State & Zip Code _____ Phone Number () _____

NARRATIVE (Print a brief description of the accident):
VEH-2 SB ON CTH-W SLOWED TO MAKE A RIGHT

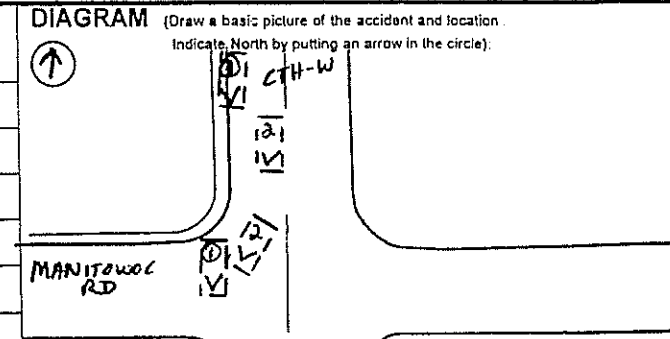

Citation/s: NO 1 V97 K241 246.08

INCIDENT #: S99-00491

CENSUS: 11024

CS 599-00242

5. INCIDENT LOCATION

6. NAME - LAST - FIRST - MI 7. D.O.B.

8. ADDRESS 9. TX-HOME

11. CITY STATE ZIP 10. TX-BUSINESS

12. DETAILS

1747 03/18/99

18. ASSIGNED COLBORN 432
MISO 929

19. REC. BY 20. DIS. BY
946

21. HOW REC'D.
1. 911
2. POLICE RADIO
3. PHONE
4. TTY
5. IN PERSON -
6. ON VIEW
7. OFF. OFF DUTY
8. C.B. RADIO
9. OTHER

22. TYPE OF REPORT
1. INCIDENT
2. ACCIDENT
3. CITATION
4. NONE

23. STATUS
1. UNFOUNDED
2. PNL
3. OTHER
4. CLEARED
5. EXCEPT CLEARED

24. DATE CLEARED 032099

25. OFFENSE TYPE
1. ADULT NA
2. JUVENILE
3. UNKNOWN

14. REC'D 15. DISP 16. 10-23 17. 10-24

13. DAY
SUN 1 THU 5
MON 2 FRI 6
TUE 3 SAT 7
WED 4

39. (CODE S-SUSPECT W-WITNESS V-VICTIM O-OTHER)						
CODE	40. NAME-LAST	FIRST	MI	41. D.O.B.	42. ADDRESS	43. TELEPHONE
O	CARLSON	DORITA	F		S 24th St, Manitowoc	
O	CARLSON	DENNIS	H		S 24th St, Manitowoc	

03/18/99 @ 1000 Hrs.: I, Deputy A. Colborn, was assigned to follow-up on this incident by D.I. Tisler. Preliminary information received from D.I. Tisler was that a party called the Air Exchange radio program sponsored by WOMT radio in the City of Manitowoc. Information was that the caller informed the disc jockey he had Chevrolet pickup truck parts for sale. The caller left a telephone number of [redacted] for interested parties to contact him at.

I contacted this telephone number and spoke with DORITA CARLSON. DORITA stated her husband, DENNIS CARLSON, had a 1978 Chevrolet full-sized pickup truck for sale. DORITA stated the truck was green in color and that DENNIS purchased it for parts only.

I then responded to [redacted] S 24th St, Manitowoc, where I made contact with DENNIS. DENNIS informed me he purchased the green Chevrolet pickup from 21ST STREET AUTO in the City of Manitowoc. DENNIS stated he purchased the vehicle with the intention of using the engine and transmission out of it. DENNIS stated he was now selling the truck for the serviceable body parts still left on it.

I observed the truck which bore VIN [redacted]. I observed this truck was a 1978 Chevy and not to have any front end damage whatsoever. I observed the grill and front bumper of the truck to be intact, and both front fenders as well as the hood were intact. I further observed the windshield was not damaged on the vehicle.

I also observed DENNIS to have a 1985 Chevy full-sized pickup truck, blue in color. This vehicle was bearing WI RP AL41721. I observed this truck was free of front end damage.

At this time, it appears this incident can be considered closed. The 1978 Chevrolet pickup truck did not have any front end damage and is older than the suspect vehicle in the fatal hit and run. The 1985 full-sized pickup truck owned by DENNIS was also free of front end damage and does not appear to be a match with the suspect vehicle in the fatal hit and run.

No further action taken at this time. A copy of this incident should be forwarded to Lt. M. Bushman and Deputy Raube for entry into the FBI Rapid Start computer program.

ALColborn /bjc

CASE # S99 No 02202

45. IF COMPLAINANT DIFFERENT THEN CALLER, ENTER NAME, ADDRESS, D.O.B., TELEPHONE.

46. IF CODE O (OTHER) IS USED IN FIELD #39, EXPLAIN.

INCIDENT REPORT: NOTE: IF SECTION 22 ABOVE HAS NUMBER 4 CHECKED, DO NOT GO BEYOND THIS LINE WITHOUT RECORDS SECTION BEING ADVISED, OR NO RECORD ENTRIES WILL BE MADE BELOW THIS LINE.

PROPERTY VALUE	26. PROPERTY	A. CURRENCY	B. JEWELRY	C. FURS CLOTHING	D. VEHICLE (LOCAL)	E. OFFICE EQUIPMENT	F. RADIO, TV CAMERAS	G. FIREARMS	H. HOUSE-HOLD GOODS
	STOLEN	\$	\$	\$	\$	\$	\$	\$	\$
	RECOVERED	\$	\$	\$	\$	\$	\$	\$	\$
	26. PROPERTY	I. CONSUMABLES	J. LIVESTOCK	K. DRUGS	L. MARINE ITEMS	M. CONSTRUCTION ITEMS	N. LAWN AND GARDEN	O. SPORTING GOODS	P. MISC BICYCLE
	STOLEN	\$	\$	\$	\$	\$	\$	\$	\$
	RECOVERED	\$	\$	\$	\$	\$	\$	\$	\$

27. PROPERTY RECOVERED: LOCALLY _____ OTHER JURISDICTION _____ (INSERT O OR L)

PROPERTY ITEMIZATION	PROPERTY STOLEN/RECOVERED ITEMIZATION, USE THE FOLLOWING FORMAT				
	28. QUANTITY	29. ARTICLE NAME	30. BRAND NAME	31. SERIAL NUMBER	32. CODE
					S R <input type="checkbox"/> <input type="checkbox"/>
					S R <input type="checkbox"/> <input type="checkbox"/>
					S R <input type="checkbox"/> <input type="checkbox"/>
					S R <input type="checkbox"/> <input type="checkbox"/>
					S R <input type="checkbox"/> <input type="checkbox"/>

33. PROPERTY DAMAGE AMOUNT \$ _____

34. INSURANCE COMPANY _____

35. OFFICER ASSAULTED Y N

36. ARSON Y N

37. STRUCTURE CODE _____

38. DAMAGE \$ _____

47. CIB ENTERED CANCELLED
 NCIC
 OTHER BROADCAST

48. TOTAL AMOUNT PROPERTY STOLEN \$ _____

49. TOTAL AMOUNT PROPERTY RECOVERED \$ _____

50. IS REPORT CONTINUED? YES NO

51. CAUTION INDICATORS, ATLS ETC.

52. DATA PROCESS INFORMATION:

COMPUTER ENTERED

DATE

3.31.99

MICROFILM INDEXED

INITIAL

KS

53. FILE APPROVAL

BY

CK

DATE

033099

IS CASE CLASSIFICATION CORRECT?
 IF N HAS CORRECTION BEEN MADE?

Y N

1. CASE # **S99 No 02161** 2. CLASSIFICATION **6301** 3. CENSUS **03015**

4. INCIDENT **CS/S99-00242**

5. INCIDENT LOCATION **SE corner Rosecrans & Grove Rds. Hickory**

6. LAST-FIRST-MI **anomy** 7. D.O.B.

8. ADDRESS 9. TX-HOME

10. TX-BUSINESS

11. STATE ZIP

12. DETAILS
Multi-colored Chev. pickup parked, for sale, and has missing grill, headlights, etc.

1000
031799

MANITOWOC COUNTY SHERIFF
INCIDENT CARD

18. ASSIGNED
BUSHMAN 441
T Beilke 492
MTSO 484

19. REC. BY **920** 20. DIS. BY

21. HOW REC'D.
 1. 911
 2. POLICE RADIO
 3. PHONE
 4. TTY
 5. IN PERSON
 6. ON VIEW
 7. OFF. OFF DUTY
 8. C.B. RADIO
 9. OTHER

22. TYPE OF REPORT
 1. INCIDENT
 2. ACCIDENT
 3. CITATION
 4. NONE

23. STATUS
 1. UNFOUNDED
 2. PNL
 3. OTHER
 4. CLEARED
 5. EXCEPT CLEARED

24. DATE CLEARED **03/30/99**

25. OFFENSE TYPE
 1. ADULT NA
 2. JUVENILE
 3. UNKNOWN

39. (CODE S-SUSPECT W-WITNESS V-VICTIM O-OTHER)	40. NAME-LAST	FIRST	MI	41. D.O.B.	42. ADDRESS	43. TELEPHONE
0	Siebold, Paul C.	80530			S. Wall St Lot 13 Denmark	
0	Rozmarynoski Chad	170532			Maple Court, Denmark	

03/20/99 0919hrs Contact made by phone with Sgt. Beilke to do a driveby area and check the vehicle. M.J. Bushman

1005hrs Vehicle is a 1981 Chev. P/U registration BK59454, listed owner above. The grill had been replaced by a pipe type after market grill spray painted black. Mounting brackets are rusty; there is a single rectangular semi-round headlamp on each side. Vehicle looks like it was rebuild from several vehicles. There is no damage to the hood, bumper or windshield. Hood could not be opened, release inside locked truck. Phone listing posted in the window with For Sale sign.

Contact made with owner Paul Siebold by phone. He stated he purchased the vehicle approximately 2 years ago from a Chad Razmonowski (spelling ?) Denmark Ph: [REDACTED] It was parked behind a barn, no motor or transmission and the box missing. Chad had intended to fix it up but never got around to it and sold it to Siebold. Siebold did not drive it much this winter because of the wide rear tires which did not have good traction. Only recently had he put it on his land with a for sale sign. Only after all the information was freely given with Siebold very cooperative did he ask what this call was in reference too. When he told an officer was there right now to view the vehicle he stated he would go out there immediately to open the hood.

Sgt. Beilke reported Siebold was very cooperative. Tires appeared to have been on the vehicle for quite some time and were measured 10 inches wide on the rear, 7 inches on the front. There was no fan shroud, radiator looked like a replace, support wall had no damage.

1045hrs Attempted contact at the Rozmarynoski residence, message left on machine. This vehicle does not fit description well, but previous owner may have information to varify Siebold's explanation. M.J. Bushman

1300hrs Chad Rozmarynoski did call MTSO. The truck in question was hauled to his friend's house and was in very poor condition with no engine, transmission, or box. Many of the wires had been cut and it took a great deal of work putting it back to road worthy condition. The last time he saw his friend's truck was around deer hunting. As far as he knew the truck had been parked since then. There was no damage to the vehicle but nothing was left of the front end when sold. This is not the vehicle we are looking for, close out. M.J. Bushman

CASE #
S99 No 02161

JOE @ Police 2/1/99
 102/20

45. IF COMPLAINANT DIFFERENT THEN CALLER, ENTER NAME, ADDRESS, D.O.B., TELEPHONE.

46. IF CODE O (OTHER) IS USED IN FIELD #39, EXPLAIN.

INCIDENT REPORT: NOTE: IF SECTION 22 ABOVE HAS NUMBER 4 CHECKED, DO NOT GO BEYOND THIS LINE WITHOUT RECORDS SECTION BEING ADVISED, OR NO RECORD ENTRIES WILL BE MADE BELOW THIS LINE.

PROPERTY VALUE	26. PROPERTY	A. CURRENCY	B. JEWELRY	C. FURS CLOTHING	D. VEHICLE (LOCAL)	E. OFFICE EQUIPMENT	F. RADIO, TV CAMERAS	G. FIREARMS	H. HOUSE-HOLD GOODS
	STOLEN	\$	\$	\$	\$	\$	\$	\$	\$
	RECOVERED	\$	\$	\$	\$	\$	\$	\$	\$
	26. PROPERTY	I. CONSUM-ABLES	J. LIVESTOCK	K. DRUGS	L. MARINE ITEMS	M. CONSTRUCTION ITEMS	N. LAWN AND GARDEN	O. SPORTING GOODS	P. MISC BICYCLE
	STOLEN	\$	\$	\$	\$	\$	\$	\$	\$
	RECOVERED	\$	\$	\$	\$	\$	\$	\$	\$

27. PROPERTY RECOVERED: LOCALLY _____ OTHER JURISDICTION _____ (INSERT O OR L)

PROPERTY ITEMIZATION	PROPERTY STOLEN/RECOVERED ITEMIZATION, USE THE FOLLOWING FORMAT				
	28. QUANTITY	29. ARTICLE NAME	30. BRAND NAME	31. SERIAL NUMBER	32. CODE
					S R <input type="checkbox"/> <input type="checkbox"/>
					S R <input type="checkbox"/> <input type="checkbox"/>
					S R <input type="checkbox"/> <input type="checkbox"/>
					S R <input type="checkbox"/> <input type="checkbox"/>
					S R <input type="checkbox"/> <input type="checkbox"/>

33. PROPERTY DAMAGE AMOUNT \$ _____ 34. INSURANCE COMPANY _____

35. OFFICER ASSAULTED Y N 36. ARSON Y N 37. STRUCTURE CODE _____ 38. DAMAGE \$ _____

47. CIB	ENTERED <input type="checkbox"/>	CANCELLED <input type="checkbox"/>	48. TOTAL AMOUNT PROPERTY STOLEN \$ _____
NCIC	<input type="checkbox"/>	<input type="checkbox"/>	
OTHER BROADCAST	<input type="checkbox"/>	<input type="checkbox"/>	
			49. TOTAL AMOUNT PROPERTY RECOVERED \$ _____

50. IS REPORT CONTINUED? YES NO 51. CAUTION INDICATORS, ATLS ETC.

52. DATA PROCESS INFORMATION:

COMPUTER ENTERED DATE 3/3/99

MICROFILM INDEXED INITIAL KS

IS CASE CLASSIFICATION CORRECT? N N
 IF N HAS CORRECTION BEEN MADE? Y N

53. FILE APPROVAL

BY AK DATE 03/30/99

MCSO 028 1/91

1. CASE # S99 No 02162 | 2. CLASSIFICATION 6301 | 3. CENSUS 53000

4. INCIDENT CS/S99-00242

5. INCIDENT LOCATION [REDACTED]

6. NAME - LAST, FIRST, MI [REDACTED] 7. D.O.B. 10/002

8. ADDRESS [REDACTED] 9. TX-HOME [REDACTED]

11. STATE ZIP [REDACTED] 10. BUSINESS [REDACTED]

12. DETAILS
 APPROX. 1118 HRS TODAY,
 BURBANDY BLAZER, # M27507
 OBSERVED PARKED. IT'S MISSING
 GRILL PARTS.

HELL 03/19/99 691/150

MANITOWOC COUNTY SHERIFF
INCIDENT CARD

18. ASSIGNED
 MTSO 929
 Jost 449

19. REC. BY 920 20. DIS. BY
 22. TYPE OF REPORT
 1. INCIDENT
 2. ACCIDENT
 3. CITATION
 4. NONE
 23. STATUS
 1. UNFOUNDED
 2. PNL
 3. OTHER
 4. CLEARED
 5. EXCEPT CLEARED
 24. DATE CLEARED 03/30/99
 25. OFFENSE TYPE
 1. ADULT NA
 2. JUVENILE
 3. UNKNOWN

21. HOW REC'D.
 1. 911
 2. POLICE RADIO
 3. PHONE
 4. TTY
 5. IN PERSON
 6. ON VIEW
 7. OFF. OFF DUTY
 8. C.B. RADIO
 9. OTHER
 21A. M.O.

14. REC'D 15. DISP 16. 10-23 17. 10-24
 SUN 1 THU 5
 MON 2 FRI 6
 TUE 3 SAT 7
 WED 4

39. (CODE S-SUSPECT W-WITNESS V-VICTIM O-OTHER)

CODE	40. NAME - LAST	FIRST	MI	41. D.O.B.	42. ADDRESS	43. TELEPHONE
O	Kuttil	Kelli	M.	[REDACTED]	Jackson St. Two Rivers	[REDACTED]
O	Welnetz	Constance	A	[REDACTED]	name	[REDACTED]

On 03-19-99 I, Deputy Jost, made phone contact with Kelli reference this crime stopper. Kelli informed me the Blazer her mother owns is a S-10 Blazer. The damage occurred when she struck a deer, reported to TRPD on 02-27-99. This was verified with WRPD. Vehicle not the same style vehicle. No follow-up needed. JMJ

CASE # S99 No 02162

45. IF COMPLAINANT DIFFERENT THEN CALLER, ENTER NAME, ADDRESS, D.O.B., TELEPHONE.

46. IF CODE O (OTHER) IS USED IN FIELD #39, EXPLAIN.

INCIDENT REPORT: NOTE: IF SECTION 22 ABOVE HAS NUMBER 4 CHECKED, DO NOT GO BEYOND THIS LINE WITHOUT RECORDS SECTION BEING ADVISED, OR NO RECORD ENTRIES WILL BE MADE BELOW THIS LINE.

PROPERTY VALUE	26. PROPERTY	A. CURRENCY	B. JEWELRY	C. FURS CLOTHING	D. VEHICLE (LOCAL)	E. OFFICE EQUIPMENT	F. RADIO, TV CAMERAS	G. FIREARMS	H. HOUSE-HOLD GOODS
	STOLEN	\$	\$	\$	\$	\$	\$	\$	\$
	RECOVERED	\$	\$	\$	\$	\$	\$	\$	\$
	26. PROPERTY	I. CONSUM-ABLES	J. LIVESTOCK	K. DRUGS	L. MARINE ITEMS	M. CONSTRUCTION ITEMS	N. LAWN AND GARDEN	O. SPORTING GOODS	P. MISC BICYCLE
	STOLEN	\$	\$	\$	\$	\$	\$	\$	\$
	RECOVERED	\$	\$	\$	\$	\$	\$	\$	\$

27. PROPERTY RECOVERED: LOCALLY _____ OTHER JURISDICTION _____ (INSERT O OR L)

PROPERTY ITEMIZATION	PROPERTY STOLEN/RECOVERED ITEMIZATION, USE THE FOLLOWING FORMAT				
	28. QUANTITY	29. ARTICLE NAME	30. BRAND NAME	31. SERIAL NUMBER	32. CODE
					S R <input type="checkbox"/> <input type="checkbox"/>
					S R <input type="checkbox"/> <input type="checkbox"/>
					S R <input type="checkbox"/> <input type="checkbox"/>
					S R <input type="checkbox"/> <input type="checkbox"/>

33. PROPERTY DAMAGE AMOUNT \$ _____ 34. INSURANCE COMPANY _____

35. OFFICER ASSAULTED Y N 36. ARSON Y N 37. STRUCTURE CODE _____ 38. DAMAGE \$ _____

47. CIB	ENTERED <input type="checkbox"/>	CANCELLED <input type="checkbox"/>	48. TOTAL AMOUNT PROPERTY STOLEN \$ _____
NCIC	<input type="checkbox"/>	<input type="checkbox"/>	
OTHER BROADCAST	<input type="checkbox"/>	<input type="checkbox"/>	

49. TOTAL AMOUNT PROPERTY RECOVERED \$ _____

50. IS REPORT CONTINUED? YES NO 51. CAUTION INDICATORS, ATLS ETC.

52. DATA PROCESS INFORMATION:

COMPUTER ENTERED DATE 130199

MICROFILM INDEXED INITIAL RS

IS CASE CLASSIFICATION CORRECT? Y N
IF N HAS CORRECTION BEEN MADE?

53. FILE APPROVAL
BY [Signature] DATE 032099

1. CASE # S99 No 02134 2. CLASSIFICATION 6310.11 3. CENSUS 1410.08

4. INCIDENT CS/S99-00242

INCIDENT LOCATION S 42 W. side N. of Schuette MFD ([redacted] STH 42)

6. NAME - LAST-FIRST-MI ANONY. 7. D.O.B.

8. ADDRESS 9. TX-HOME

11. CITY STATE ZIP 10. TX-BUSINESS

12. DETAILS

Brown van observed between 2 barns. Appears to have grill damage. Reg. unk. This was 1015 hrs. today.

1104
031699

REC'D 4.	15. DISP	16. 10-23	17. 10-24
13. DAY			
SUN 1	THU 5		
MON 2	FRI 6		
TUE 3	SAT 7		
WED 4			

MANITOWOC COUNTY SHERIFF
INCIDENT CARD

18. ASSIGNED MTSO 9129
M. Bushman 4141

19. REC. BY 920 20. DIS. BY

21. HOW REC'D.

1. 911
2. POLICE RADIO
3. PHONE
4. TTY
5. IN PERSON
6. ON VIEW
7. OFF. OFF DUTY
8. C.B. RADIO
9. OTHER

21A. M.O.

22. TYPE OF REPORT
1. INCIDENT
2. ACCIDENT
3. CITATION
4. NONE

23. STATUS
1. UNFOUNDED
2. PNL
3. OTHER
4. CLEARED
5. EXCEPT CLEARED

24. DATE CLEARED 033099

25. OFFENSE TYPE
1. ADULT NA
2. JUVENILE
3. UNKNOWN

39. (CODE S-SUSPECT W-WITNESS V-VICTIM O-OTHER)

CODE	40. NAME-LAST	FIRST	MI	41. D.O.B.	42. ADDRESS	43. TELEPHONE

03/16/99 1630hrs Old Brown Chev. van parked between two barns with flat tires sinking into mud grape vines growing over the top of it. Registration CB 51433 no longer on file. Van does not have matching damage to the front and does not look like it has been operated for over a year. Close Complaint. M.J. Bushman

MJB

45. IF COMPLAINANT DIFFERENT THEN CALLER, ENTER NAME, ADDRESS, D.O.B., TELEPHONE.

46. IF CODE O (OTHER) IS USED IN FIELD #39, EXPLAIN.

INCIDENT REPORT: NOTE: IF SECTION 22 ABOVE HAS NUMBER 4 CHECKED, DO NOT GO BEYOND THIS LINE WITHOUT RECORDS SECTION BEING ADVISED, OR NO RECORD ENTRIES WILL BE MADE BELOW THIS LINE.

PROPERTY VALUE	26. PROPERTY	A. CURRENCY	B. JEWELRY	C. FURS CLOTHING	D. VEHICLE (LOCAL)	E. OFFICE EQUIPMENT	F. RADIO, TV CAMERAS	G. FIREARMS	H. HOUSE-HOLD GOODS
	STOLEN	\$	\$	\$	\$	\$	\$	\$	\$
	RECOVERED	\$	\$	\$	\$	\$	\$	\$	\$
	26. PROPERTY	I. CONSUM-ABLES	J. LIVESTOCK	K. DRUGS	L. MARINE ITEMS	M. CONSTRUCTION ITEMS	N. LAWN AND GARDEN	O. SPORTING GOODS	P. MISC BICYCLE
	STOLEN	\$	\$	\$	\$	\$	\$	\$	\$
	RECOVERED	\$	\$	\$	\$	\$	\$	\$	\$

27. PROPERTY RECOVERED: LOCALLY _____ OTHER JURISDICTION _____ (INSERT O OR L)

PROPERTY ITEMIZATION	PROPERTY STOLEN/RECOVERED ITEMIZATION, USE THE FOLLOWING FORMAT				
	28. QUANTITY	29. ARTICLE NAME	30. BRAND NAME	31. SERIAL NUMBER	32. CODE
					S <input type="checkbox"/> R <input type="checkbox"/>
					S <input type="checkbox"/> R <input type="checkbox"/>
					S <input type="checkbox"/> R <input type="checkbox"/>
					S <input type="checkbox"/> R <input type="checkbox"/>

33. PROPERTY DAMAGE AMOUNT \$ _____

34. INSURANCE COMPANY _____

35. OFFICER ASSAULTED Y N

36. ARSON Y N

37. STRUCTURE CODE _____

38. DAMAGE \$ _____

47. CIB ENTERED CANCELLED
 NCIC
 OTHER BROADCAST

48. TOTAL AMOUNT PROPERTY STOLEN \$ _____

49. TOTAL AMOUNT PROPERTY RECOVERED \$ _____

50. IS REPORT CONTINUED? YES NO

51. CAUTION INDICATORS, ATLS ETC.

52. DATA PROCESS INFORMATION:

COMPUTER ENTERED DATE 1/31/99
 MICROFILM INDEXED INITIAL KS

53. FILE APPROVAL

BY [Signature] DATE 03/30/99

IS CASE CLASSIFICATION CORRECT? Y N
 IF N HAS CORRECTION BEEN MADE? Y N

1. CASE # S99 No 02125 | 2. CLASSIFICATION 631011 | 3. CENSUS 521000

4. INCIDENT CS/S99-00242

5. INCIDENT LOCATION Custon

6. NAME - LAST - FIRST - MI anon @ | 7. D.O.B.

8. ADDRESS | 9. TX-HOME

11. CITY STATE ZIP | 10. TX-BUSINESS

12. DETAILS
 Rps 80's Chev Blazer - white
 w/ front end damage parked
 at Golden Flame

3-15-99 2304
 2309
 2311
 REC'D 14. 15. 16. 17.
 DISP 10-23 10-24
 13. DAY
 SUN 1 THU 5
 MON 2 FRI 6
 TUE 3 SAT 7
 WED 4

MANITOWOC COUNTY SHERIFF
 INCIDENT CARD

18. ASSIGNED MTSO 9219
 Janssen 4114
 M. Rushman 4411

19. REC. BY 928 | 20. DIS. BY
 22. TYPE OF REPORT
 1. INCIDENT
 2. ACCIDENT
 3. CITATION
 4. NONE

21. HOW REC'D.
 1. 911
 2. POLICE RADIO
 3. PHONE
 4. TTY
 5. IN PERSON
 6. ON VIEW
 7. OFF. OFF DUTY
 8. C.B. RADIO
 9. OTHER

23. STATUS
 1. UNFOUNDED
 2. PNL
 3. OTHER
 4. CLEARED
 5. EXCEPT CLEARED

24. DATE CLEARED 10/3/99

25. OFFENSE TYPE
 1. ADULT NA
 2. JUVENILE
 3. UNKNOWN

39. (CODE S-SUSPECT W-WITNESS V-VICTIM O-OTHER)				41. D.O.B.		42. ADDRESS		43. TELEPHONE
CODE	NAME-LAST	FIRST	MI					
	Duellman	Jess	C			Casey St, Mtwa		

3-15-99 2309 hrs. Sgt Janssen checked this vehicle and does not feel it is the correct one. 414/928

03/16/99 1008hrs This is the second vehicle we checked owned by Duellman.
 1) 86 Chev Truck Reg: MJX417
 2) 78 Chev truck Reg: BH87641

Close. M. J. Rushman

1080
 200-442/10
 10/1/99

45. IF COMPLAINANT DIFFERENT THEN CALLER, ENTER NAME, ADDRESS, D.O.B., TELEPHONE.

46. IF CODE O (OTHER) IS USED IN FIELD #39, EXPLAIN.

INCIDENT REPORT: NOTE: IF SECTION 22 ABOVE HAS NUMBER 4 CHECKED, DO NOT GO BEYOND THIS LINE WITHOUT RECORDS SECTION BEING ADVISED, OR NO RECORD ENTRIES WILL BE MADE BELOW THIS LINE.

PROPERTY VALUE	26. PROPERTY	A. CURRENCY	B. JEWELRY	C. FURS CLOTHING	D. VEHICLE (LOCAL)	E. OFFICE EQUIPMENT	F. RADIO, TV CAMERAS	G. FIREARMS	H. HOUSE-HOLD GOODS
	STOLEN	\$	\$	\$	\$	\$	\$	\$	\$
	RECOVERED	\$	\$	\$	\$	\$	\$	\$	\$
	26. PROPERTY	I. CONSUM-ABLES	J. LIVESTOCK	K. DRUGS	L. MARINE ITEMS	M. CONSTRUCTION ITEMS	N. LAWN AND GARDEN	O. SPORTING GOODS	P. MISC BICYCLE
	STOLEN	\$	\$	\$	\$	\$	\$	\$	\$
	RECOVERED	\$	\$	\$	\$	\$	\$	\$	\$

27. PROPERTY RECOVERED: LOCALLY _____ OTHER JURISDICTION _____ (INSERT O OR L)

PROPERTY ITEMIZATION	PROPERTY STOLEN/RECOVERED ITEMIZATION, USE THE FOLLOWING FORMAT				
	28. QUANTITY	29. ARTICLE NAME	30. BRAND NAME	31. SERIAL NUMBER	
					S R <input type="checkbox"/> <input type="checkbox"/>
					S R <input type="checkbox"/> <input type="checkbox"/>
					S R <input type="checkbox"/> <input type="checkbox"/>
					S R <input type="checkbox"/> <input type="checkbox"/>

33. PROPERTY DAMAGE AMOUNT \$ _____ 34. INSURANCE COMPANY _____

35. OFFICER ASSAULTED Y N 36. ARSON Y N 37. STRUCTURE CODE _____ 38. DAMAGE \$ _____

47. CIB	ENTERED <input type="checkbox"/>	CANCELLED <input type="checkbox"/>	48. TOTAL AMOUNT PROPERTY STOLEN \$ _____
NCIC	<input type="checkbox"/>	<input type="checkbox"/>	
OTHER BROADCAST	<input type="checkbox"/>	<input type="checkbox"/>	49. TOTAL AMOUNT PROPERTY RECOVERED \$ _____

50. IS REPORT CONTINUED? YES NO 51. CAUTION INDICATORS, ATLS ETC.

52. DATA PROCESS INFORMATION:

COMPUTER ENTERED DATE 10/1/99
 MICROFILM INDEXED INITIAL KS

IS CASE CLASSIFICATION CORRECT? Y N
 IF N HAS CORRECTION BEEN MADE? Y N

53. FILE APPROVAL
 BY [Signature] DATE 10/30/99

1. CASE # 599-02247 2. CLASSIFICATION 6,3|0,1 3. CENSUS 1,4|0,1,1

4. INCIDENT CS/ 599-00242

5. INCIDENT LOCATION

NAME - LAST - FIRST - MI 7. D.O.B.

Anon

8. ADDRESS 9. TX-HOME

11. CITY STATE ZIP 10. TX-BUSINESS

12. DETAILS
REC'd report of MJX417 a white Chev Blazer

with grill damage in the city of MTWC.

12:25 3-20-99

14. REC'D	15. DISP	16. 10-23	17. 10-24
13. DAY			
SUN 1	THU 5		
MON 2	FRI 6		
TUE 3	SAT 7		
WED 4			

MANITOWOC COUNTY SHERIFF
 INCIDENT CARD

18. ASSIGNED

19. REC. BY 9/26 20. DIS. BY

21. HOW REC'D.
 1. 911
 2. POLICE RADIO
 3. PHONE
 4. TTY
 5. IN PERSON
 6. ON VIEW
 7. OFF. OFF DUTY
 8. C.B. RADIO
 9. OTHER

22. TYPE OF REPORT
 1. INCIDENT
 2. ACCIDENT
 3. CITATION
 4. NONE

23. STATUS
 1. UNFOUNDED
 2. PNL
 3. OTHER
 4. CLEARED
 5. EXCEPT CLEARED

24. DATE CLEARED 10/4/2009

25. OFFENSE TYPE
 1. ADULT NA
 2. JUVENILE
 3. UNKNOWN

4011

39. (CODE S-SUSPECT W-WITNESS V-VICTIM O-OTHER)				42. ADDRESS		43. TELEPHONE
CODE	40. NAME-LAST	FIRST	MI	41. D.O.B.		
O	Duellman, Jess E	<u>W/1084</u>			<u>Easy St. Mtwc</u>	

03/24/99 Duellman was the subject from a previous check on two vehicles BH 87641 Trk and MJX 417 Aut both cleared in Complaint# S99-02125. Close out. M.J. Bushman

ALREADY ENTERED - ETC

599-02247

45. IF COMPLAINANT DIFFERENT THEN CALLER, ENTER NAME, ADDRESS, D.O.B., TELEPHONE.

46. IF CODE O (OTHER) IS USED IN FIELD #39, EXPLAIN.

INCIDENT REPORT: NOTE: IF SECTION 22 ABOVE HAS NUMBER 4 CHECKED, DO NOT GO BEYOND THIS LINE WITHOUT RECORDS SECTION BEING ADVISED, OR NO RECORD ENTRIES WILL BE MADE BELOW THIS LINE.

PROPERTY VALUE	26. PROPERTY	A. CURRENCY	B. JEWELRY	C. FURS CLOTHING	D. VEHICLE (LOCAL)	E. OFFICE EQUIPMENT	F. RADIO, TV CAMERAS	G. FIREARMS	H. HOUSE-HOLD GOODS
	STOLEN	\$	\$	\$	\$	\$	\$	\$	\$
	RECOVERED	\$	\$	\$	\$	\$	\$	\$	\$
	26. PROPERTY	I. CONSUMABLES	J. LIVESTOCK	K. DRUGS	L. MARINE ITEMS	M. CONSTRUCTION ITEMS	N. LAWN AND GARDEN	O. SPORTING GOODS	P. MISC BICYCLE
	STOLEN	\$	\$	\$	\$	\$	\$	\$	\$
	RECOVERED	\$	\$	\$	\$	\$	\$	\$	\$

27. PROPERTY RECOVERED: LOCALLY _____ OTHER JURISDICTION _____ (INSERT O OR L)

PROPERTY ITEMIZATION	PROPERTY STOLEN/RECOVERED ITEMIZATION, USE THE FOLLOWING FORMAT				
	28. QUANTITY	29. ARTICLE NAME	30. BRAND NAME	31. SERIAL NUMBER	32. CODE
					S R <input type="checkbox"/> <input type="checkbox"/>
					S R <input type="checkbox"/> <input type="checkbox"/>
					S R <input type="checkbox"/> <input type="checkbox"/>
					S R <input type="checkbox"/> <input type="checkbox"/>
					S R <input type="checkbox"/> <input type="checkbox"/>

33. PROPERTY DAMAGE AMOUNT \$ _____ 34. INSURANCE COMPANY _____

35. OFFICER ASSAULTED Y N 36. ARSON Y N 37. STRUCTURE CODE _____ 38. DAMAGE \$ _____

47. CIB	ENTERED <input type="checkbox"/>	CANCELLED <input type="checkbox"/>	48. TOTAL AMOUNT PROPERTY STOLEN \$ _____
NCIC	<input type="checkbox"/>	<input type="checkbox"/>	
OTHER BROADCAST	<input type="checkbox"/>	<input type="checkbox"/>	49. TOTAL AMOUNT PROPERTY RECOVERED \$ _____

50. IS REPORT CONTINUED? YES NO

51. CAUTION INDICATORS, ATLS ETC.

52. DATA PROCESS INFORMATION:

COMPUTER ENTERED DATE 10/29/99
 MICROFILM INDEXED INITIAL RS
 IS CASE CLASSIFICATION CORRECT? Y N
 IF N HAS CORRECTION BEEN MADE? Y N

53. FILE APPROVAL

BY [Signature] DATE 10/4/2000

CASE # No 02289 2. CLASSIFICATION 6,310,1 3. CENSUS 1,40,1,2

99-00242

NAME - LAST - FIRST - MI

7. D.O.B.

ADDRESS

9. TX-HOME

11. CITY

STATE ZIP 54241

10. TX-BUSINESS

12. DETAILS

Reports a [redacted], Daniel R. 087
 Cichantek M/W [redacted] had a brown Chevy
 S10 pickup truck. When cpl asked Daniel
 what happened to the pickup he said that

03-22-99 0945

14. REC'D 15. DISP 16. 10-23 17. 10-24
 13. DAY
 SUN 1 THU 5
 MON 2 FRI 6
 TUE 3 SAT 7
 WED 4

MANITOWOC COUNTY SHERIFF INCIDENT CARD

18. ASSIGNED
 MTSO 9/12/19
 M. Bushman H.H.W.

19. REC. BY 901 20. DIS. BY ---
 22. TYPE OF REPORT
 1. INCIDENT
 2. ACCIDENT
 3. CITATION
 4. NONE

21. HOW REC'D.
 1. 911
 2. POLICE RADIO
 3. PHONE
 4. TTY
 5. IN PERSON
 6. ON VIEW
 7. OFF. OFF DUTY
 8. C.B. RADIO
 9. OTHER
 23. STATUS
 1. UNFOUNDED
 2. PNL
 3. OTHER
 4. CLEARED
 5. EXCEPT CLEARED

24. DATE CLEARED 10/3/09
 25. OFFENSE TYPE
 1. ADULT NA
 2. JUVENILE
 3. UNKNOWN

39. (CODE S-SUSPECT W-WITNESS V-VICTIM O-OTHER)						
CODE	40. NAME-LAST	FIRST	MI	41. D.O.B.	42. ADDRESS	43. TELEPHONE
O	Cichantek Daniel R.			[redacted]	[redacted] S21st St. Mtwc	[redacted]
S99-00427						

he flipped it over on the interstate. This would have been the approximate time that this fatal accident occurred. Daniel lives at [redacted] S. 21 St., Manitowoc. See interview form. ks/901

03/23/99 Information provided is true the vehicle in question was a S-10 Chev P/U not what we are looking for. Accident report number #5822566 S99-00574 occurred 011999. Close out complaint. M.J. Bushman

KATS

45. IF COMPLAINANT DIFFERENT THEN CALLER, ENTER NAME, ADDRESS, D.O.B., TELEPHONE.

46. IF CODE O (OTHER) IS USED IN FIELD #39, EXPLAIN.

INCIDENT REPORT: NOTE: IF SECTION 22 ABOVE HAS NUMBER 4 CHECKED, DO NOT GO BEYOND THIS LINE WITHOUT RECORDS SECTION BEING ADVISED, OR NO RECORD ENTRIES WILL BE MADE BELOW THIS LINE.

PROPERTY VALUE	26. PROPERTY	A. CURRENCY	B. JEWELRY	C. FURS CLOTHING	D. VEHICLE (LOCAL)	E. OFFICE EQUIPMENT	F. RADIO, TV CAMERAS	G. FIREARMS	H. HOUSE-HOLD GOODS
	STOLEN	\$	\$	\$	\$	\$	\$	\$	\$
	RECOVERED	\$	\$	\$	\$	\$	\$	\$	\$
	26. PROPERTY	I. CONSUMABLES	J. LIVESTOCK	K. DRUGS	L. MARINE ITEMS	M. CONSTRUCTION ITEMS	N. LAWN AND GARDEN	O. SPORTING GOODS	P. MISC BICYCLE
	STOLEN	\$	\$	\$	\$	\$	\$	\$	\$
	RECOVERED	\$	\$	\$	\$	\$	\$	\$	\$

27. PROPERTY RECOVERED: LOCALLY _____ OTHER JURISDICTION _____ (INSERT O OR L)

PROPERTY ITEMIZATION	PROPERTY STOLEN/RECOVERED ITEMIZATION, USE THE FOLLOWING FORMAT				
	28. QUANTITY	29. ARTICLE NAME	30. BRAND NAME	31. SERIAL NUMBER	32. CODE
					S R <input type="checkbox"/> <input type="checkbox"/>
					S R <input type="checkbox"/> <input type="checkbox"/>
					S R <input type="checkbox"/> <input type="checkbox"/>
					S R <input type="checkbox"/> <input type="checkbox"/>
					S R <input type="checkbox"/> <input type="checkbox"/>

33. PROPERTY DAMAGE AMOUNT \$ _____

34. INSURANCE COMPANY _____

35. OFFICER ASSAULTED Y N

36. ARSON Y N

37. STRUCTURE CODE _____ 38. DAMAGE \$ _____

47. CIB ENTERED CANCELLED
 NCIC
 OTHER BROADCAST

48. TOTAL AMOUNT PROPERTY STOLEN \$ _____

49. TOTAL AMOUNT PROPERTY RECOVERED \$ _____

50. IS REPORT CONTINUED? YES NO

51. CAUTION INDICATORS, ATLS ETC.

52. DATA PROCESS INFORMATION:

COMPUTER ENTERED DATE 3/31/99
 MICROFILM INDEXED INITIAL KS

IS CASE CLASSIFICATION CORRECT? N
 IF N HAS CORRECTION BEEN MADE? Y

53. FILE APPROVAL

BY [Signature] DATE 03/30/99

5822566

Amended Document On Emergency

Document Number Override

Wisconsin Motor Vehicle Accident Report

Please Do Not Write In This Microfilm Space

INSTRUCTIONS
Please use a Black Ink Pen or #2 Pencil.
Mark Areas as shown:
Correct Mark
Incorrect Marks

County	36	MUN/TWP	16
1	0	1	0
2	1	2	1
3	2	3	2
4	3	4	3
5	4	5	4
6	5	6	5
7	6	7	6
8	7	8	7
9	8	9	8

Accident Date		
MONTH	DAY	YEAR
Jan	1	1999
Feb	2	0
Mar	3	0
Apr	4	1
May	5	2
June	6	3
July	7	4
Aug	8	5
Sept	9	6
Oct	0	7
Nov	1	8
Dec	2	9

Time of Accident (Military Time)	
HOUR	MIN.
07	25
0	0
1	1
2	2
3	3
4	4
5	5
6	6
7	7
8	8
9	9

Total Number		
UNITS	INJURED	KILLED
01	00	00
1	1	1
2	2	2
3	3	3
4	4	4
5	5	5
6	6	6
7	7	7
8	8	8
9	9	9

Hit & Run
 Government Property
 Fire (Narrative)
 Photos Taken (Narrative)
 Trailer or Towed (Narrative)
 Truck or Bus (Last Page)
 Load Spillage
 Construction Zone
 Names Exchanged

Sheet No.
Of
11

ACCIDENT LOCATION
 Public Highway, Intersection/Related
 Public Highway, Non-Intersection
 Parking Lot
 Private Property or Road

LATITUDE (GPS) Degrees: Minutes: Seconds: LONGITUDE (GPS) Degrees: Minutes: Seconds:

ON Hwy No. and / Street Name: **STH 67** Estimated FT. MI. FROM/AT Hwy No. and / Street Name: **CTH XX**

House # Fire # Other Agency Space
 Utility # Railroad # 17

Unit Number	Unit Type	Total Number of Occupants	Direction of Travel (Before the Accident)	Unit Number	Unit Type	Total Number of Occupants	Direction of Travel (Before the Accident)
2 3 4	1 3 4	0 2 3 4 5 6	W E	1 2 3 4	1 2 3 4	0 1 2 3 4 5 6	W E
5 6 7 8	5 6 7	Other	S	5 6 7	Other		S
9 10				9 10			

Speed Limit	OPERATOR Last NAME	First	M.I.	Speed Limit	OPERATOR Last NAME	First	M.I.
0	2	LICHANTEK	DANIEL R.	0	25		
1	ADDRESS	Street & Number		1	ADDRESS	Street & Number	
2	26	S 21 ST		2	26		
3	City & State	ZIP	Phone Number ()	3	City & State	ZIP	Phone Number ()
4	MANITOWOC, WI	54220	(920)	4	27		28
5	Driver's License Number	State	Exp. Year	5	Driver's License Number	State	Exp. Year
6		WI	06	6			

Date of Birth	Sex	Operating as Classified	Class (Mark Only One)	Endorse (Mark All That Apply)	Date of Birth	Sex	Operating as Classified	Class (Mark Only One)	Endors. (Mark All That App.)
32	M	Y	A	H P T N S F	32	F	Y	A	H P T N S
On Duty Accident	P Police	CMV			On Duty Accident	F EMT-Paramedic	CMV		
	E EMT-Paramedic					F Fire Fighter			
	F Fire Fighter					H Winter Hwy Maintenance			
	H Winter Hwy Maintenance								

Severity	SEAT Position	SAFETY Equipment	AIRBAG	EJECTED	Severity	SEAT Position	SAFETY Equipment	AIRBAG	EJECTED
(K) (N)	1	1	(1) Deployed	(1) Not Applicable (4) Partially Ejected	(K) (N)	1	1	(1) Deployed	(1) Not Applicable (4) Partially Ejected
(A)			(2) Non Deployed	(2) Not Ejected (6) Unknown	(A)			(2) Non Deployed	(2) Not Ejected (6) Unknown
(B)			(3) Not Applicable	(3) Totally Ejected	(B)			(3) Not Applicable	(3) Totally Ejected
(C)			(4) Unknown		(C)			(4) Unknown	

TRAPPED/EXTRICATED Not Applicable Trapped/Extricated Unknown Medical Transport

Vehicle Owner Same Last Name First M.I.

Street Address

City & State ZIP Phone Number ()

Year of Vehicle Make Model Body Style Color

Vehicle ID Number

License Plate Number Plate Type State Exp. Year

Policy Holder's Name Citation Policy Holder's Name Same Citation

Liability Insurance Company Stat. # Liability Insurance Company Stat. #

Occupant Unit Number NAME Last First M.I. Date of Birth Sex

ADDRESS Street & Number City & State ZIP

Address Same as Operator EJECTED TRAPPED/EXTRICATED Medical Transport

MV4000 1293

Agency Space

EMS Number

Police No. S99-00574

Date 10/19

Location

1. CASE # S99 No 02272 2. CLASSIFICATION 6310.11 3. CENSUS 5310.00

4. INCIDENT CS/ES 599-00242

5. INCIDENT LOCATION City of Two Rivers

6. NAME- LAST-FIRST-MI 7. D.O.B.

8. A 9. TX-HOME

11. CITY STATE ZIP 10. TX-BUSINESS

12. DETAILS
 Ofc. Christianson made contact with registered owner of TRT 341. Hagron, Carol M. due to front end damage observed - ope stated hit seagull

1146
3-21-99

14. REC'D 15. DISP 16. 10-23 17. 10-24
 13. DAY
 SUN 1 THU 5
 MON 2 FRI 6
 TUE 3 SAT 7
 WED 4

MANITOWOC COUNTY SHERIFF INCIDENT CARD

18. ASSIGNED
 MTSO 9129
 M. Bushman 441

19. REC. BY 947 20. DIS. BY 947
 22. TYPE OF REPORT
 1. INCIDENT
 2. ACCIDENT
 3. CITATION
 4. NONE

21. HOW REC'D.
 1. 911
 2. POLICE RADIO
 3. PHONE
 4. TTY
 5. IN PERSON
 6. ON VIEW
 7. OFF. OFF DUTY
 8. C.B. RADIO
 9. OTHER
 23. STATUS
 1. UNFOUNDED
 2. PNL
 3. OTHER
 4. CLEARED
 5. EXCEPT CLEARED

24. DATE CLEARED 03/30/99
 25. OFFENSE TYPE
 1. ADULT NA
 2. JUVENILE
 3. UNKNOWN

39. (CODE S-SUSPECT W-WITNESS V-VICTIM O-OTHER)				40. NAME-LAST FIRST MI		41. D.O.B.	42. ADDRESS	43. TELEPHONE
0	Gagnon, Carol M.					34th St. Two Rivers		

3-21-99 (continued)

Officer Christianson requested that this information be passed on to Lt. Bushman. ss/947 03/23/99 Contact made by phone with Off. Christianson. I was confused as to whether he wanted me to recheck the vehicle or is it just for computer entry that it was checked. The vehicle was checked Close Out. M.J. Bushman

45. IF COMPLAINANT DIFFERENT THEN CALLER, ENTER NAME, ADDRESS, D.O.B., TELEPHONE.

46. IF CODE O (OTHER) IS USED IN FIELD #39, EXPLAIN.

INCIDENT REPORT: NOTE: IF SECTION 22 ABOVE HAS NUMBER 4 CHECKED, DO NOT GO BEYOND THIS LINE WITHOUT RECORDS SECTION BEING ADVISED, OR NO RECORD ENTRIES WILL BE MADE BELOW THIS LINE.

PROPERTY VALUE	26. PROPERTY	A. CURRENCY	B. JEWELRY	C. FURS CLOTHING	D. VEHICLE (LOCAL)	E. OFFICE EQUIPMENT	F. RADIO, TV CAMERAS	G. FIREARMS	H. HOUSE-HOLD GOODS
	STOLEN	\$	\$	\$	\$	\$	\$	\$	\$
	RECOVERED	\$	\$	\$	\$	\$	\$	\$	\$
	26. PROPERTY	I. CONSUMABLES	J. LIVESTOCK	K. DRUGS	L. MARINE ITEMS	M. CONSTRUCTION ITEMS	N. LAWN AND GARDEN	O. SPORTING GOODS	P. MISC BICYCLE
STOLEN	\$	\$	\$	\$	\$	\$	\$	\$	
RECOVERED	\$	\$	\$	\$	\$	\$	\$	\$	

27. PROPERTY RECOVERED: LOCALLY _____ OTHER JURISDICTION _____ (INSERT O OR L)

PROPERTY ITEMIZATION	PROPERTY STOLEN/RECOVERED ITEMIZATION, USE THE FOLLOWING FORMAT				
	28. QUANTITY	29. ARTICLE NAME	30. BRAND NAME	31. SERIAL NUMBER	32. CODE
					S <input type="checkbox"/> R <input type="checkbox"/>
					S <input type="checkbox"/> R <input type="checkbox"/>
					S <input type="checkbox"/> R <input type="checkbox"/>
					S <input type="checkbox"/> R <input type="checkbox"/>
					S <input type="checkbox"/> R <input type="checkbox"/>

33. PROPERTY DAMAGE AMOUNT \$ _____ 34. INSURANCE COMPANY _____

35. OFFICER ASSAULTED Y N 36. ARSON Y N 37. STRUCTURE CODE _____ 38. DAMAGE \$ _____

47. CIB <input type="checkbox"/>	ENTERED <input type="checkbox"/>	CANCELLED <input type="checkbox"/>	48. TOTAL AMOUNT PROPERTY STOLEN \$ _____
NCIC <input type="checkbox"/>	<input type="checkbox"/>	<input type="checkbox"/>	
OTHER BROADCAST <input type="checkbox"/>	<input type="checkbox"/>	<input type="checkbox"/>	
			49. TOTAL AMOUNT PROPERTY RECOVERED \$ _____

50. IS REPORT CONTINUED? YES NO 51. CAUTION INDICATORS, ATLS ETC.

52. DATA PROCESS INFORMATION:

COMPUTER ENTERED DATE 3/31/99

MICROFILM INDEXED INITIAL KS

IS CASE CLASSIFICATION CORRECT? IF N HAS CORRECTION BEEN MADE? Y N

53. FILE APPROVAL

BY OK DATE 03/30/99

1. CASE # **S99 No 02540** 2. CLASSIFICATION **6301** 3. CENSUS **60000**

4. INCIDENT **CS/S99-00242**

5. INCIDENT LOCATION **41st and Calumet**

6. NAME LAST-FIRST MI [REDACTED] 7. D.O.B. [REDACTED]

8. ADDRESS [REDACTED] 9. TX-HOME [REDACTED]

11. CITY **Mtwc** STATE ZIP 10. TX-BUSINESS

12. DETAILS
The Comp. works for insulation and Supply Co. Today approximately 1230hrs she observed a Wh. van with Reg: AK10482 ? stop & deliver news papers at [REDACTED] Calumet Ave. Mtwc. The entire grill was missing. She was unsure of plate as she only saw a flash while passing by.

033099 2003

MANITOWOC COUNTY SHERIFF INCIDENT CARD

18. ASSIGNED **info** 9/8/99

19. REC. BY **g44** 20. DIS. BY **g44**

21. HOW REC'D.
 1. 911
 2. POLICE RADIO
 3. PHONE
 4. TTY
 5. IN PERSON
 6. ON VIEW
 7. OFF. OFF DUTY
 8. C.B. RADIO
 9. OTHER

22. TYPE OF REPORT
 1. INCIDENT
 2. ACCIDENT
 3. CITATION
 4. NONE

23. STATUS
 1. UNFOUNDED
 2. PNL
 3. OTHER
 4. CLEARED
 5. EXCEPT CLEARED

24. DATE CLEARED **09/13/99**

25. OFFENSE TYPE
 1. ADULT
 2. JUVENILE
 3. UNKNOWN

39. (CODE S-SUSPECT W-WITNESS V-VICTIM O-OTHER)						
CODE	40. NAME-LAST	FIRST	MI	41. D.O.B.	42. ADDRESS	43. TELEPHONE
O	SCHMIAT	WARREN	W	[REDACTED]	EAST ST TWO RIVER	[REDACTED]
D	SCHENKLE	BRENDA	R.	[REDACTED]	50-10TH #6 Mtwc	[REDACTED]
D	SCHENKLE	ROBERT	R.	[REDACTED]	10TH #6 Mtwc	[REDACTED]

The driver was a white male approximately 35 years old with shoulder length sandy blond hair.

Complainant was unsure of the plate letter prefix and a number of possibilities were run. AM comes back out of Mishicot, AL Silver Lake, Wi., AK Mosinee, Wi. The Mishicot address can be checked but if it were to be a negative, someone on afternoon shift or overlap should sit near [REDACTED] and attempt to locate wh van with similar plate as newspapers are printed every day.

0245hrs Attempted to locate 89 Chevy at [REDACTED] E. Samz Rd., Mishicot. Home has a three car garage vehicle not located. M.J. Bushman

03/31/99: I, Deputy L. A. Bushman, was assigned to this incident. I did attempt to check the address of [REDACTED] Calumet Ave. in the City of Manitowoc. I was unable to locate that address. I did check at the Cenex Station, Culture Cafe, Pietroske's, and Larry's Shell, but met with negative results in locating anyone that would deliver newspapers with a white van. Also the addresses of Wal-Mart, Fazoli's, Office Max, and Culvers were checked and did not correspond with [REDACTED] Calumet Ave. The reverse directory and street index was also checked and showed no address.

Myself as well as Dispatch was unable to locate the original Crime Stopper complaint to see if a complainant was listed on the questionnaire and subsequent callback to get a better location was met with negative results. I did stay in the area between 1200-1300 hrs. to see if I could locate a white van matching the description and again met with negative results.

I did contact Mishicot PD Officer Remiker who did check at [REDACTED] E. Samz Rd., Mishicot, and met with negative results in locating the van that apparently is listed to that address. Officer Remiker did state that he spoke with a neighbor to that address who stated that the people at [REDACTED] E. Samz Rd. do own a van; however, it is newer, mid 1990's, and they do not believe it would match the description of the one we are looking for. However, no contact was made at the residence and no visual contact was made of the van listing to that address.

At this time further follow up is required regarding the complainant or the subject that

Case # S99 No 02540

45. IF COMPLAINANT DIFFERENT THEN CALLER, ENTER NAME, ADDRESS, D.O.B., TELEPHONE.

46. IF CODE O (OTHER) IS USED IN FIELD #39, EXPLAIN.

INCIDENT REPORT: NOTE: IF SECTION 22 ABOVE HAS NUMBER 4 CHECKED, DO NOT GO BEYOND THIS LINE WITHOUT RECORDS SECTION BEING ADVISED, OR NO RECORD ENTRIES WILL BE MADE BELOW THIS LINE.

PROPERTY VALUE	26. PROPERTY	A. CURRENCY	B. JEWELRY	C. FURS CLOTHING	D. VEHICLE (LOCAL)	E. OFFICE EQUIPMENT	F. RADIO, TV CAMERAS	G. FIREARMS	H. HOUSE-HOLD GOODS
	STOLEN	\$	\$	\$	\$	\$	\$	\$	\$
	RECOVERED	\$	\$	\$	\$	\$	\$	\$	\$
	26. PROPERTY	I. CONSUMABLES	J. LIVESTOCK	K. DRUGS	L. MARINE ITEMS	M. CONSTRUCTION ITEMS	N. LAWN AND GARDEN	O. SPORTING GOODS	P. MISC BICYCLE
STOLEN	\$	\$	\$	\$	\$	\$	\$	\$	
RECOVERED	\$	\$	\$	\$	\$	\$	\$	\$	

27. PROPERTY RECOVERED: LOCALLY ____ OTHER JURISDICTION ____ (INSERT O OR L)

PROPERTY ITEMIZATION	PROPERTY STOLEN/RECOVERED ITEMIZATION, USE THE FOLLOWING FORMAT				
	28. QUANTITY	29. ARTICLE NAME	30. BRAND NAME	31. SERIAL NUMBER	32. CODE
					S <input type="checkbox"/> R <input type="checkbox"/>
					S <input type="checkbox"/> R <input type="checkbox"/>
					S <input type="checkbox"/> R <input type="checkbox"/>
					S <input type="checkbox"/> R <input type="checkbox"/>

33. PROPERTY DAMAGE AMOUNT \$ _____ 34. INSURANCE COMPANY _____

35. OFFICER ASSAULTED Y N 36. ARSON Y N 37. STRUCTURE CODE _____ 38. DAMAGE \$ _____

47. CIB	ENTERED <input type="checkbox"/>	CANCELLED <input type="checkbox"/>	48. TOTAL AMOUNT PROPERTY STOLEN \$ _____
NCIC	<input type="checkbox"/>	<input type="checkbox"/>	
OTHER BROADCAST	<input type="checkbox"/>	<input type="checkbox"/>	
			49. TOTAL AMOUNT PROPERTY RECOVERED \$ _____

50. IS REPORT CONTINUED? YES NO 51. CAUTION INDICATORS, ATLS ETC.

52. DATA PROCESS INFORMATION:

COMPUTER ENTERED DATE 6/29/99

MICROFILM INDEXED INITIAL RS

IS CASE CLASSIFICATION CORRECT? Y N

IF N HAS CORRECTION BEEN MADE? Y N

53. FILE APPROVAL

BY [Signature] DATE 06/29/99

MANITOWOC COUNTY SHERIFF'S DEPARTMENT
FOLLOW-UP REPORT

Page: 2

CASE NUMBER: 599 - 02540 CLASSIFICATION: _____

INCIDENT: _____

DATE AND TIME: _____

REPORT CONTINUED:

called Crime Stoppers to get a possible better location and possibly what type of newspaper was being delivered. LABushman [redacted] /paf
04/09/99 1520hrs Contact by phone made with [redacted] She was advised Officers had checked the area she said the suspect vehicle was located on Calumet Ave. near Walmart. The address and vehicle was not located. She then stated "Did I say Calumet Ave., I meant Custer Street, I always get the two mixed up. She again stated it would be 4023 a corner house.

Contact attempted at [redacted] Custer Street before reporting for work, no one home. The name on the mailbox was Ron & Marge Hacker.

Contact made by phone with Ron Hacker. He stated his son delivers the Herald-Times Reporter. The rout has been in his family approximately 5 years. The papers are delivered to their door each day anywhere between 1230hrs to 1500hrs. by a white van. Ron Hacker stated the same man delivers the papers each time and the white van does have the grill knocked out but that the Hackers did not report the vehicle as a Crime-Stoppers as they thought police were looking for a Chev van, this van is a Dodge Cargo van.

Officers did check the Herald-Times parking lot and viewed two white Chev vans, neither had damage and neither had registration close to the original reported plate. Contact will be made during business hours. M.J.Bushman
04/16/99 Check was made of the Herald Times parking lot for the vehicle registration close to the number called in. Contact was made with an employee who was asked if all the delivery vans were owned by Herald Times and would they be in the parking lot after hours. He stated the Paper Bundle Haulers are private. Warren Schmidt would be the supervisor who should have a complete list of private haulers and available Monday during regular business hours.
Warren Schmidt, Home Delivery Manager M.J.Bushman

04/19/99 1414hrs Message left.

04/26/99 1425hrs Contact made with Warren Schmidt at Herald Times. He apologized for not getting back to me stating we have opposite schedules. The incident was described to him and he immediately stated he knew of the carrier and that the van involved is a Dodge mini-cargo van. Driver's name is unknown but Schmidt described him as about 30 years old white male "scraggly looking" shoulder length hair. He stated the van is operated by Brenda A. Schindler and possibly is in the process of being sold to this male driver.

1435hrs Message left on Brenda Schindler's answering machine.

2030hrs Brenda Schmidt called MISO. The incident was outlined to her and she stated the van used for that delivery route is a Dodge cargo van and does have the grill missing from a car vs deer accident on I-43 in May 98, she stated she was the driver. Accident report photocopy face attached. Registration THG 529 on report not even close to the called in van for this complaint. Vin number was run and current registration is AM 10442 very close to the plate number originally called in. I believe this to be the vehicle the Complainant saw and called in and it would not be a match for the suspect vehicle. Close out report.

M.J. Bushman

Wisconsin Motor Vehicle Accident Report

Please Do Not Write In This Microfilm Space

Document Number Override

0

Accident No. 598-03954

INSTRUCTIONS: Please use a Black Ink Pen or #2 Pencil. Mark Areas as shown: Correct Mark, Incorrect Marks, Reportable Accident.

County: 36, MUN/TWP: 03

Accident Date: MONTH DAY YEAR, 11 9 8

Time of Accident (Military Time): HOUR MIN., 03 20

Total Number: UNITS INJURED KILLED, 01 7 8

Hit & Run: Government Property, Fire (Narrative), Photos Taken (Narrative), Trailer or Towed (Narrative), Truck or Bus (Last Page), Load Spillage, Construction Zone, Names Exchanged.

Sheet No. Of: 11

ACCIDENT LOCATION: Public Highway, Intersection/Related, Public Highway, Non-Intersection, Parking Lot, Private Property or Road.

LATITUDE (GPS) Degrees: Minutes: Seconds: LONGITUDE (GPS) Degrees: Minutes: Seconds:

ON Hwy No. and / Street Name: I-43, Estimated: .2, FROM/AT Hwy No. and / Street Name: HIDDEN VALLEY RD

House #, Fire #, Other, Utility #, Railroad #, Agency Space, Special Study

Unit Number, Unit Type, Total Number of Occupants, Direction of Travel (Before the Accident)

Operator: Last Name, First, M.I., ADDRESS, Street & Number, City & State, ZIP, Phone Number, Driver's License Number, State, Exp. Year

Date of Birth, Sex, Operating as, Class (Mark Only One), Endorse (Mark All That Apply), On Duty Accident

Severity, SEAT Position, SAFETY Equipment, AIRBAG, EJECTED, TRAPPED/EXTRICATED

Vehicle Owner, Last Name, First, M.I., Same, Street Address, City & State, ZIP, Phone Number

Year of Vehicle, Make, Model, Body Style, Color, Vehicle ID Number

License Plate Number, Plate Type, State, Exp. Year, Policy Holder's Name, Citation

Liability Insurance Company, Stat. #, Occupant Unit Number, NAME, Last, First, M.I., Date of Birth, Sex

Occupant Unit Number, ADDRESS, Street & Number, City & State, ZIP, SEVERITY, SEAT Position, SAFETY Equipment, AIRBAG

Address Same as Operator, EJECTED, TRAPPED/EXTRICATED, Medical Transport, Agency Space

Police No. 598-03954, Date, Location

JAMES A. MCINTYRE

RZK 598

ALL INFORMATION CONTAINED
HEREIN IS UNCLASSIFIED
DATE 08-20-2003 BY
[REDACTED]

45. IF COMPLAINANT DIFFERENT THEN CALLER, ENTER NAME, ADDRESS, D.O.B., TELEPHONE.

46. IF CODE O (OTHER) IS USED IN FIELD #39, EXPLAIN.

INCIDENT REPORT: NOTE: IF SECTION 22 ABOVE HAS NUMBER 4 CHECKED, DO NOT GO BEYOND THIS LINE WITHOUT RECORDS SECTION BEING ADVISED, OR NO RECORD ENTRIES WILL BE MADE BELOW THIS LINE.

PROPERTY VALUE	26. PROPERTY	A. CURRENCY	B. JEWELRY	C. FURS CLOTHING	D. VEHICLE (LOCAL)	E. OFFICE EQUIPMENT	F. RADIO, TV CAMERAS	G. FIREARMS	H. HOUSE-HOLD GOODS
	STOLEN	\$	\$	\$	\$	\$	\$	\$	\$
	RECOVERED	\$	\$	\$	\$	\$	\$	\$	\$
	26. PROPERTY	I. CONSUMABLES	J. LIVESTOCK	K. DRUGS	L. MARINE ITEMS	M. CONSTRUCTION ITEMS	N. LAWN AND GARDEN	O. SPORTING GOODS	P. MISC BICYCLE
STOLEN	\$	\$	\$	\$	\$	\$	\$	\$	
RECOVERED	\$	\$	\$	\$	\$	\$	\$	\$	

27. PROPERTY RECOVERED: LOCALLY ____ OTHER JURISDICTION ____ (INSERT O OR L)

PROPERTY ITEMIZATION	PROPERTY STOLEN/RECOVERED ITEMIZATION, USE THE FOLLOWING FORMAT				
	28. QUANTITY	29. ARTICLE NAME	30. BRAND NAME	31. SERIAL NUMBER	32. CODE
					S <input type="checkbox"/> R <input type="checkbox"/>
					S <input type="checkbox"/> R <input type="checkbox"/>
					S <input type="checkbox"/> R <input type="checkbox"/>
					S <input type="checkbox"/> R <input type="checkbox"/>
					S <input type="checkbox"/> R <input type="checkbox"/>
					S <input type="checkbox"/> R <input type="checkbox"/>

33. PROPERTY DAMAGE AMOUNT \$ _____

34. INSURANCE COMPANY _____

35. OFFICER ASSAULTED Y N

36. ARSON Y N

37. STRUCTURE CODE _____

38. DAMAGE \$ _____

47. CIB ENTERED CANCELLED
 NCIC
 OTHER BROADCAST

48. TOTAL AMOUNT PROPERTY STOLEN \$ _____

49. TOTAL AMOUNT PROPERTY RECOVERED \$ _____

50. IS REPORT CONTINUED? YES NO

51. CAUTION INDICATORS, ATLS ETC.

52. DATA PROCESS INFORMATION:

COMPUTER ENTERED DATE 1/6/99

MICROFILM INDEXED INITIAL AS

IS CASE CLASSIFICATION CORRECT? N
 IF N HAS CORRECTION BEEN MADE? N

53. FILE APPROVAL

BY [Signature]

DATE 04/12/99

Search Criteria:

Search for:

Search in:

<input checked="" type="checkbox"/> Last Name	<input type="checkbox"/> First Name	<input type="checkbox"/> Middle Name	<input type="checkbox"/> Category
<input type="checkbox"/> Place Of Birth	<input type="checkbox"/> Race	<input type="checkbox"/> Occupation	<input type="checkbox"/> Family/Associates
<input type="checkbox"/> Address 1	<input type="checkbox"/> Sex	<input type="checkbox"/> SSN	<input type="checkbox"/> Method Of Operation
<input type="checkbox"/> Address 2	<input type="checkbox"/> Height	<input type="checkbox"/> FBI Number	<input type="checkbox"/> Criminal History
<input type="checkbox"/> City	<input type="checkbox"/> Weight	<input type="checkbox"/> File Number	<input type="checkbox"/> Other
<input type="checkbox"/> State	<input type="checkbox"/> Clothing	<input type="checkbox"/> Other Number	
<input type="checkbox"/> Zip Code	<input type="checkbox"/> Facial Characteristics		
			<input type="checkbox"/> Entered By
			<input type="checkbox"/> Last Modified By

Name: WILCOX, APRIL J Race: Sex: Height: Weight: Hair Color: Eye Color:

Address: [REDACTED] JOHNSTON DR
MANITOWOC,

Category:
Facial Characteristics: ATK BE60436 CHEV 88
Clothing: CHECKED NO MATCH
Occupation:

DOB: Place of Birth: SSN:

Family/Associates:
Method of Operation:
Criminal History:
Other:
Aliases:

Phone Numbers - Number: Type:

Name: WILCOX, KEVIN Race: Sex: Height: Weight: Hair Color: Eye Color:

Address: [REDACTED] W CORTEZ CIR APT 6
FRANKLIN,

Category:
Facial Characteristics: NSA769 BLK CHEV BLAZER
Clothing: CHECKED NO MATCH
Occupation:

DOB: Place of Birth: SSN:

Family/Associates:
Method of Operation:
Criminal History:
Other:
Aliases:

Phone Numbers - Number: Type:

599-2304

1. CASE # S99 No 02553		2. CLASSIFICATION 631011		3. CENSUS 70000	
4. INCIDENT CS/599-00242					
5. INCIDENT LOCATION					
6. NAME - LAST-FIRST-MI [REDACTED] (70378)				7. D.O.B. [REDACTED]	
8. [REDACTED]				9. TX-HOME [REDACTED]	
11. CITY [REDACTED]		STATE [REDACTED]		ZIP [REDACTED]	
10. TX-BUSINESS					
12. DETAILS Saw woman delivering mlw sent. clearing a gray pu.					
14. REC'D		15. DISP		16. 10-23	
17. 10-24		13. DAY		18. 10-24	
SUN 1		THU 5		MON 2	
TUE 3		SAT 7		WED 3	
19. REC. BY 901					
20. DIS. BY					
21. HOW REC'D. 1. 911 2. POLICE RADIO 3. PHONE 4. TTY 5. IN PERSON 6. ON VIEW 7. OFF. OFF DUTY 8. C.B. RADIO 9. OTHER					
22. TYPE OF REPORT 1. INCIDENT 2. ACCIDENT 3. CITATION 4. NONE					
23. STATUS 1. UNFOUNDED 2. PNL 3. OTHER 4. CLEARED 5. EXCEPT CLEARED					
24. DATE CLEARED 04/12/99					
25. OFFENSE TYPE 1. ADULT <input type="checkbox"/> NA <input type="checkbox"/> 2. JUVENILE <input type="checkbox"/> 3. UNKNOWN <input type="checkbox"/>					
21A. M.O.					

03-31-99 0930

MANITOWOC COUNTY SHERIFF
INCIDENT CARD

18. ASSIGNED
Sgt Lenk 204

39. (CODE S-SUSPECT W-WITNESS V-VICTIM O-OTHER)					
40. CODE	41. NAME-LAST	FIRST	MI	42. D.O.B.	43. ADDRESS
0	Grosskopf, Cynthia M.	31320		[REDACTED]	Dewey St., Mtwc

03/31/99 2120hrs Contact made with the complainant by phone. She stated she talked to an officer earlier in the day but then gave me the same information. She was making breakfast 0610hrs this morning and the news on TV had the information about the van in our custody. She stated at that moment she had a "Fleeting Thought" that you know some times you might not recognize the vehicle if it was right under your nose all along. Something which looks out of place might be what your looking for and if you call it to someones attention it may just check out. She said she just happened to look up at that time and saw a P/U parked in the street a short distance away. She never saw that there before at this hour. She saw a heavy set woman walk to the truck, get in on the driver's side and then park in front of her house. She then realized the woman was delivering newspapers and delivered one to the next door neighbors Frank and Gwen Polc [REDACTED]. The woman walked with a limp. She had no idea of the truck make, could not see damage, it just seemed odd, and she never saw it before. Given the thoughts in her mind at the time and the odd occurrence, she called in a Crimestopper report. Truck was gray color with hand landscape type tools in open bed. Contact made by phone with Gwen Polc and she gets the Sentinel-Journal at that hour delivered by Cindy Grosskopf who drives a P/U truck, Ph: [REDACTED]. Contact attempted several times by phone, no answer. Off. Bessler checked the residence listed above and found a small gray P/U with tools lying in the bed, registration AD32988 comes back to Gary and Cynthia Grosskopf on an 89 Mazda, no damage. Close Out. M.J. Bushman

ENTERED ETC-

MA

1300 2450 PM 212

45. IF COMPLAINANT DIFFERENT THEN CALLER, ENTER NAME, ADDRESS, D.O.B., TELEPHONE.

46. IF CODE O (OTHER) IS USED IN FIELD #39, EXPLAIN.

INCIDENT REPORT: NOTE: IF SECTION 22 ABOVE HAS NUMBER 4 CHECKED, DO NOT GO BEYOND THIS LINE WITHOUT RECORDS SECTION BEING ADVISED, OR NO RECORD ENTRIES WILL BE MADE BELOW THIS LINE.

PROPERTY VALUE	26. PROPERTY	A. CURRENCY	B. JEWELRY	C. FURS CLOTHING	D. VEHICLE (LOCAL)	E. OFFICE EQUIPMENT	F. RADIO, TV CAMERAS	G. FIREARMS	H. HOUSE-HOLD GOODS
	STOLEN	\$	\$	\$	\$	\$	\$	\$	\$
	RECOVERED	\$	\$	\$	\$	\$	\$	\$	\$
	26. PROPERTY	I. CONSUMABLES	J. LIVESTOCK	K. DRUGS	L. MARINE ITEMS	M. CONSTRUCTION ITEMS	N. LAWN AND GARDEN	O. SPORTING GOODS	P. MISC BICYCLE
STOLEN	\$	\$	\$	\$	\$	\$	\$	\$	
RECOVERED	\$	\$	\$	\$	\$	\$	\$	\$	

27. PROPERTY RECOVERED: LOCALLY ____ OTHER JURISDICTION ____ (INSERT O OR L)

PROPERTY ITEMIZATION	PROPERTY STOLEN/RECOVERED ITEMIZATION, USE THE FOLLOWING FORMAT				31. SERIAL NUMBER	32. CODE
	28. QUANTITY	29. ARTICLE NAME	30. BRAND NAME			
						S R <input type="checkbox"/> <input type="checkbox"/>
						S R <input type="checkbox"/> <input type="checkbox"/>
						S R <input type="checkbox"/> <input type="checkbox"/>
						S R <input type="checkbox"/> <input type="checkbox"/>
						S R <input type="checkbox"/> <input type="checkbox"/>
						S R <input type="checkbox"/> <input type="checkbox"/>

33. PROPERTY DAMAGE AMOUNT \$ _____ 34. INSURANCE COMPANY _____

35. OFFICER ASSAULTED Y N 36. ARSON Y N 37. STRUCTURE CODE _____ 38. DAMAGE \$ _____

47. CIB ENTERED CANCELLED
 NCIC
 OTHER BROADCAST

48. TOTAL AMOUNT PROPERTY STOLEN \$ _____

49. TOTAL AMOUNT PROPERTY RECOVERED \$ _____

50. IS REPORT CONTINUED? YES NO

51. CAUTION INDICATORS, ATLS ETC.

52. DATA PROCESS INFORMATION:
 COMPUTER ENTERED DATE 16 29 99
 MICROFILM INDEXED INITIAL AS
 IS CASE CLASSIFICATION CORRECT? N
 IF N HAS CORRECTION BEEN MADE? N

53. FILE APPROVAL
 BY AK DATE 04/12/99

1. CASE # S99 No 02566		2. CLASSIFICATION 6310.11		3. CENSUS 3810.00	
4. INCIDENT CS/ See S99-00242					
5. INCIDENT LOCATION Roosevelt - Valders					
6. NAME LAST FIRST MI [REDACTED] 170750				7. D.O.B. [REDACTED]	
8. [REDACTED]				9. TX-HOME [REDACTED]	
11. CITY [REDACTED]		STATE ZIP [REDACTED]		10. TX-BUSINESS [REDACTED]	
12. DETAILS Compl reports she saw vehicle matching description w/grill damage approx 1230 today 3/31/99 see attached					
14. REC'D 1300		15. DISP 1300		17. 10-24 WED 4	
16. 10-23 THU 5		17. 10-24 FRI 6		13. DAY TUE 3 SAT 7	
19. REC. BY 947			20. DIS. BY 947		22. TYPE OF REPORT 1. INCIDENT
21. HOW REC'D. 2. POLICE RADIO			23. STATUS 3. OTHER		24. DATE CLEARED 04/20/99
21A.M.O.			25. OFFENSE TYPE 1. ADULT		25. OFFENSE TYPE <input type="checkbox"/> NA <input type="checkbox"/>
			2. JUVENILE <input type="checkbox"/>		3. UNKNOWN <input type="checkbox"/>
18. ASSIGNED MTSO 9/2/9					
MANITOWOC COUNTY SHERIFF INCIDENT CARD					

39. (CODE S-SUSPECT W-WITNESS V-VICTIM O-OTHER)
 CODE: 40. NAME-LAST FIRST MI 41. D.O.B. 42. ADDRESS 43. TELEPHONE

03/31/99 2050hrs Contact made by phone with the complainant. She was unable to obtain a plate number, but does frequent two residences work related in the area. She will keep an eye out for the vehicle in the future.

Vehicle described as a Wh.GMC van with gray/blk stripes on side, left side(driver)grill damage, did not appear anything else hood or bumper damaged. No description of driver, caller feels its a personal van not delivery.

2200hrs Off.Froehlich working patrol checked driveways and streets in area in an attempt to locate.

2240hrs Unable to locate van in Valders.M.J.Bushmart

04/16/99 Vehicle not located,Close Out. M.J.Bushmart

45. IF COMPLAINANT DIFFERENT THEN CALLER, ENTER NAME, ADDRESS, D.O.B., TELEPHONE.

46. IF CODE O (OTHER) IS USED IN FIELD #39, EXPLAIN.

INCIDENT REPORT: NOTE: IF SECTION 22 ABOVE HAS NUMBER 4 CHECKED, DO NOT GO BEYOND THIS LINE WITHOUT RECORDS SECTION BEING ADVISED, OR NO RECORD ENTRIES WILL BE MADE BELOW THIS LINE.

P R O P E R T Y V A L U E	26. PROPERTY	A. CURRENCY	B. JEWELRY	C. FURS CLOTHING	D. VEHICLE (LOCAL)	E. OFFICE EQUIPMENT	F. RADIO, TV CAMERAS	G. FIREARMS	H. HOUSE-HOLD GOODS
	STOLEN	\$	\$	\$	\$	\$	\$	\$	\$
	RECOVERED	\$	\$	\$	\$	\$	\$	\$	\$
	26. PROPERTY	I. CONSUMABLES	J. LIVESTOCK	K. DRUGS	L. MARINE ITEMS	M. CONSTRUCTION ITEMS	N. LAWN AND GARDEN	O. SPORTING GOODS	P. MISC BICYCLE
STOLEN	\$	\$	\$	\$	\$	\$	\$	\$	
RECOVERED	\$	\$	\$	\$	\$	\$	\$	\$	

27. PROPERTY RECOVERED: LOCALLY _____ OTHER JURISDICTION _____ (INSERT O OR L)

P R O P E R T Y I T E M I Z A T I O N	PROPERTY STOLEN/RECOVERED ITEMIZATION, USE THE FOLLOWING FORMAT				
	28. QUANTITY	29. ARTICLE NAME	30. BRAND NAME	31. SERIAL NUMBER	32. CODE
					S R <input type="checkbox"/> <input type="checkbox"/>
					S R <input type="checkbox"/> <input type="checkbox"/>
					S R <input type="checkbox"/> <input type="checkbox"/>
					S R <input type="checkbox"/> <input type="checkbox"/>
					S R <input type="checkbox"/> <input type="checkbox"/>

33. PROPERTY DAMAGE AMOUNT \$ _____

34. INSURANCE COMPANY _____

35. OFFICER ASSAULTED Y N

36. ARSON Y N

37. STRUCTURE CODE _____

38. DAMAGE \$ _____

47. CIB

ENTERED

CANCELLED

NCIC

OTHER BROADCAST

48. TOTAL AMOUNT PROPERTY STOLEN \$ _____

49. TOTAL AMOUNT PROPERTY RECOVERED \$ _____

50. IS REPORT CONTINUED? YES NO

51. CAUTION INDICATORS, ATLS ETC.

52. DATA PROCESS INFORMATION:

COMPUTER ENTERED

DATE

6/29/99

MICROFILM INDEXED

INITIAL

AB

53. FILE APPROVAL

BY

gme

DATE

04/20/99

IS CASE CLASSIFICATION CORRECT?
IF N HAS CORRECTION BEEN MADE?

N
 N

1. CASE # S99 No 02293 | 2. CLASSIFICATION 631011 | 3. CENSUS 5,210,00

4. CS 1999-00242

5. LOCATION South 27th and Wollmer streets.

6. NAME - LAST - FIRST - MI MTPD (3) | 7. D.O.B.

8. ADDRESS | 9. TX-HOME

11. CITY STATE ZIP | 10. TX-BUSINESS

12. DETAILS Reg. incident started - will fill in details.

1007
03-22-99
14. REC'D
15. DISP
16. 10-23
17. 10-24
13. DAY
SUN 1 THU 5
MON 2 FRI 6
TUE 3 SAT 7
WED 4

MANITOWOC COUNTY SHERIFF INCIDENT CARD	
18. ASSIGNED Lt. Busitman	4441
19. REC. BY 930	20. DIS. BY
22. TYPE OF REPORT ① INCIDENT 2 ACCIDENT 3 CITATION 4 NONE	
21. HOW REC'D. 1 911 ② POLICE RADIO 3 PHONE 4 TTY 5 IN PERSON 6 ON VIEW 7 OFF. OFF DUTY 8 C.B. RADIO 9 OTHER	
23. STATUS 1 UNFOUNDED 2 PNL ③ OTHER 4 CLEARED 5 EXCEPT CLEARED	
24. DATE CLEARED 10/20/99	
25. OFFENSE TYPE 1 ADULT <input type="checkbox"/> NA <input type="checkbox"/> 2 JUVENILE <input type="checkbox"/> 3 UNKNOWN <input type="checkbox"/>	
21A. M.O.	

39. (CODE S-SUSPECT W-WITNESS V-VICTIM O-OTHER)				41. D.O.B.	42. ADDRESS	43. TELEPHONE
CODE	40. NAME-LAST	FIRST	MI			

03/22/99 City Of Manitowoc Police Off. Trainer recieved information from an anonymous source who overheard a suspicious phone conversation. The source thought it may be related to the fatal hit and run accident on CTH CR.
 Information sheet attached and copy of report turned over to Detective Dick in the City Police Department who agreed to followup. M.J.Bushman

03/26/99 Contact by phone made with Det.Dick and he advised this complaint is nearly complete report will be forthcoming shortly. M.J.Bushman

04/07/99 Report received from Manitowoc PD, Close out. M.J.Bushman

S99 No 02293

45. IF COMPLAINANT DIFFERENT THEN CALLER, ENTER NAME, ADDRESS, D.O.B., TELEPHONE.

46. IF CODE O (OTHER) IS USED IN FIELD #39, EXPLAIN.

INCIDENT REPORT: NOTE: IF SECTION 22 ABOVE HAS NUMBER 4 CHECKED, DO NOT GO BEYOND THIS LINE WITHOUT RECORDS SECTION BEING ADVISED, OR NO RECORD ENTRIES WILL BE MADE BELOW THIS LINE.

PROPERTY VALUE	26. PROPERTY	A. CURRENCY	B. JEWELRY	C. FURS CLOTHING	D. VEHICLE (LOCAL)	E. OFFICE EQUIPMENT	F. RADIO, TV CAMERAS	G. FIREARMS	H. HOUSE-HOLD GOODS
	STOLEN	\$	\$	\$	\$	\$	\$	\$	\$
	RECOVERED	\$	\$	\$	\$	\$	\$	\$	\$
	26. PROPERTY	I. CONSUM-ABLES	J. LIVESTOCK	K. DRUGS	L. MARINE ITEMS	M. CONSTRUCTION ITEMS	N. LAWN AND GARDEN	O. SPORTING GOODS	P. MISC BICYCLE
	STOLEN	\$	\$	\$	\$	\$	\$	\$	\$
	RECOVERED	\$	\$	\$	\$	\$	\$	\$	\$

27. PROPERTY RECOVERED: LOCALLY _____ OTHER JURISDICTION _____ (INSERT O OR L)

PROPERTY ITEMIZATION	PROPERTY STOLEN/RECOVERED ITEMIZATION, USE THE FOLLOWING FORMAT				
	28. QUANTITY	29. ARTICLE NAME	30. BRAND NAME	31. SERIAL NUMBER	32. CODE
					S R <input type="checkbox"/> <input type="checkbox"/>
					S R <input type="checkbox"/> <input type="checkbox"/>
					S R <input type="checkbox"/> <input type="checkbox"/>
					S R <input type="checkbox"/> <input type="checkbox"/>

33. PROPERTY DAMAGE AMOUNT \$ _____ 34. INSURANCE COMPANY _____

35. OFFICER ASSAULTED Y N 36. ARSON Y N 37. STRUCTURE CODE _____ 38. DAMAGE \$ _____

47. CIB	ENTERED <input type="checkbox"/>	CANCELLED <input type="checkbox"/>	48. TOTAL AMOUNT PROPERTY STOLEN \$ _____
NCIC	<input type="checkbox"/>	<input type="checkbox"/>	
OTHER BROADCAST	<input type="checkbox"/>	<input type="checkbox"/>	49. TOTAL AMOUNT PROPERTY RECOVERED \$ _____

50. IS REPORT CONTINUED? YES NO 51. CAUTION INDICATORS, ATLS ETC.

52. DATA PROCESS INFORMATION:
 COMPUTER ENTERED DATE 10/20/99
 MICROFILM INDEXED INITIAL KS
 IS CASE CLASSIFICATION CORRECT? Y N
 IF N HAS CORRECTION BEEN MADE? Y N

53. FILE APPROVAL
 BY JMP DATE 10/20/99

ATTENTION MTSO ACCIDENT INVESTIGATIONS

I, Officer Trainor on 03-15-99 received information from an unknown party who heard a suspicious phone conversation. This party felt it may be related to the fatal hit and run accident on Hwy CR. This party would live in the area of S. 27th and Wollmer Streets. He has a scanner which picked up a phone conversation. The range of his scanner would be approximately a 2 block area from his residence. The parties heard in the phone conversation sounded to be roommates. Two were brothers named Randy & Terry. He did not hear the name of the third subject involved in the conversation. In the phone conversation the unknown subject wanted to get his belongings from their residence. He was moving out because of a beating he had received from the two brothers. The injuries he would have received from this beating would have placed him in the hospital. The unknown subject was in contact with a lawyer, and the lawyer wanted to pursue the brothers for the beating. The unknown subjects said if he got in trouble, the two brothers would get in trouble also. He went on to say he wanted the brothers to go to his lawyer and sign paperwork stating that the unknown party was never in the vehicle on the day in question. The two brothers said the vehicle has been cleaned up and has been disposed of in another state. The party talking to me thought this would be the vehicle involved in the fatal hit and run accident on Hwy CR. He did not get a description of the vehicle or the day the subject was supposedly not to have been in the vehicle. This party also told me there is a good chance the call may have been related to [redacted] Wollmer Street. He did not know the parties living at this address, but does know male subjects live at this residence. He also told me the phone conversation he heard took place approximately 4 weeks ago. Also the subject that was talking to me did not want to give his name.

Officer Trainor/emp

599-12293
 03 22 99
 AKT. ACC CITY PD.

Mike,

Utility listing shows
a Terri M. Mueller
at [REDACTED] Wallmen.

This is a female
according to in-house.
I've attached her
printout.

In the event that
address is incorrect,
I can think of 2
brothers, Terry and
Randy DeBauche, who
have been in trouble
in past.

Shelly

27750-11 Buskman

CITY OF MANITOWOC		DEPARTMENT OF POLICE			OFFENSE REPORT				
3. CENSUS 5 2 083	4. INCIDENT Assist MTSO/Hit & Run Hochstsetler				13. DAY SUN 1 THUR 5 MON 2 FRI 6 TUES 3 SAT 7 WED 4		18. OFFICERS Dick	NO. 879	
2. CLASSIFICATION 915	5. INCIDENT LOCATION 2600blk Wollmer St				14. DATE 03-15-99				
6. NAME LAST - FIRST - MI MTSO		NUMBER 46	7. D.O.B.		14. TIME 0700				
8. ADDRESS S 9th St.				9. PHONE-HOME					
11. CITY Manitowoc		STATE WI	ZIP CODE 54220		10. PHONE-WORK		21. HOW REC'D 1. 911 4. TTY 5. IN PERSON 7. OFF. OFF DUTY 2. POLICE RADIO 3. PHONE 6. ON VIEW 8. C.B. RADIO 9. OTHER		
22. TYPE OF REPORT 1. INCIDENT 2. ACCIDENT 3. CITATION 4. NONE		23. STATUS 1. UNFOUNDED 2. PENDING 3. CLEARED 4. CLEARED BY ARREST 5. EXCEPT CLEARED		24. DATE CLEARED		25. OFFENSE TYPE 1. ADULT <input checked="" type="checkbox"/> 2. JUVENILE <input type="checkbox"/> 3. UNKNOWN <input type="checkbox"/>		19. REC'D BY Trainor 895 ENTERED D P BY DATE MAR 25 1999	

1. CASE NUMBER
99
No
02516

39. (CODE S-SUSPECT W-WITNESS V-VICTIM O-OTHER)	40. NAME - LAST	FIRST	MI	41. DOB	NUMBER	42. ADDRESS	43. TELEPHONE
O	Mueller, Terri M.				80183	Wollmer St.; Mtwc	
O	Mueller, Dylan R.				104137	same as the property	
O	Harlow, Kevin S.				1665	same as the property	

3. 20000205 - 20002500

I, Officer Trainor on 03-15-99 received information from an unknown party who heard a suspicious phone conversation. This party felt it may be related to the fatal hit and run accident on Hwy CR. This party would live in the area of S. 27th and Wollmer Streets. He has a scanner which picked up a phone conversation. The range of his scanner would be approximately a 2 block area from his residence. The parties heard in the phone conversation sounded to be roommates. Two were brothers named Randy & Terry. He did not hear the name of the third subject involved in the conversation. In the phone conversation the unknown subject wanted to get his belongings from their residence. He was moving out because of a beating he had received from the two brothers. The injuries he would have received from this beating would have placed him in the hospital. The unknown subject was in contact with a lawyer, and the lawyer wanted to pursue the brothers for the beating. The unknown subjects said if he got in trouble, the two brothers would get in trouble also. He went on to say he wanted the brothers to go to his lawyer and sign paperwork stating that the unknown party was never in the vehicle on the day in question. The two brothers said the vehicle has been cleaned up and has been disposed of in another state. The party talking to me thought this would be the vehicle involved in the fatal hit and run accident on Hwy CR. He did not get a description of the vehicle or the day the subject was supposedly not to have been in the vehicle. This party also told me there is a good chance the call may have been related to Wollmer Street. He did not know the parties living at this address, but does know male subjects live at this residence. He also told me the phone conversation he heard took place approximately 4 weeks ago. Also the subject that was talking to me did not want to give his name.

Officer Trainor/emp

Signed: _____
SHIFT COMMANDER

On 3/24/99, I, Det. Dick, looked through the MTPD files and did a search of all the January, February and March Fight calls and Disorderly Conduct calls. By entering in the Case Numbers of each of these calls, I was able to scan the addresses and names of the people involved. I was unable to find an incident where two brothers would have been involved in a fight. Also, there was only one person who lived in the area of 26th & Wollmer Street. This incident was M99-01867. The suspect in that case was EDUARDO PEREZ; his address was [REDACTED] Wollmer Street. When I looked through that report I found that EDUARDO was in a fight with one other male in the 1800 Blk of Washington Street. There was a witness to that incident and the witness claimed that there were only two people involved in the fight. This fight did not match the information that was given to Off. Trainor.

On 3/25/99, I, Det. Dick, did go to [REDACTED] Wollmer Street. I found that this was a single family house that was occupied by KEVIN HARLOW, TERRI MUELLER, and her son, DYLAN MUELLER. TERRI MUELLER informed me that she did sell a car about two weeks ago. This car was a red Chevy Celebrity that was quite rusted out. She said that she does have a cordless phone that she uses all the time. I explained to her some of the information that I had received from Off. Trainor's report. I did not give her all the details. She said that she was talking about buying a car from the Chicago area. She heard through a friend at work that they have auctions in Spring and you can get a good deal. I then spoke with DYLAN MUELLER. DYLAN said that about two weeks ago the Sheboygan P.D. came to Manitowoc to speak with him about a Hit & Run that happened in Sheboygan. DYLAN said that the Sheboygan officer cleared him from that incident. That report would be M99-01868. I did recall this incident and remember that DYLAN was indeed cleared of any wrong doing from the Hit & Run. DYLAN explained that he left the bowling alley at approximately the same time that the Hit & Run occurred. He said that he was not involved but may have spoken about it over the phone. DYLAN and TERRI MUELLER along with KEVIN HARLOW denied having anything to do with the Hit & Run. None of the vehicles registered to MUELLER were consistent with the suspect vehicle in this Hit & Run. For more information see MTSO CRIMESTOPPER REPORT NO. S99-20293.

Det. O. Dick/fm

THIS DOCUMENT IS THE PROPERTY OF THE
SHEBOYGAN POLICE DEPARTMENT. A COPY
IS PROVIDED AT YOUR REQUEST. THIS
COPY IS DEEMED CONFIDENTIAL
AND IS TO BE USED ONLY FOR
OFFICIAL PURPOSES.
SHEBOYGAN POLICE DEPARTMENT
3/15/99

1. CASE # S99 No 02304 2. CLASSIFICATION 6.310.11 3. CENSUS 7.010.00

MANITOWOC COUNTY SHERIFF
INCIDENT CARD

4. INCIDENT # S99-00242
5. INCIDENT LOCATION SHEBOYGAN / CTH CR

18. ASSIGNED Glaeser 417
SBSO 938
929

6. NAME - LAST - FIRST - MI Anonymous 7. D.O.B.

8. ADDRESS 9. TX-HOME 10. TX-BUSINESS

19. REC. BY 922 20. DIS. BY 922 22. TYPE OF REPORT 1 INCIDENT ACCIDENT 2 CITATION 3 NONE

11. CITY STATE ZIP 10. TX-BUSINESS

12. DETAILS Black older Blazer. Info is attached.

14. REC'D 032399 0640
15. DISP 4 0745
16. 10-23 032399 0849
17. 10-24 0850

21. HOW REC'D. 1. 911 2. POLICE RADIO 3. PHONE 4. TTY 5. IN PERSON 6. ON VIEW 7. OFF. OFF DUTY 8. C.B. RADIO 9. OTHER 23. STATUS 1. UNFOUNDED 2. PNL 3. OTHER 4. CLEARED 5. EXCEPT CLEARED

13. DAY SUN 1 THU 5 MON 2 FRI 6 TUE 3 SAT 7 WED 4

24. DATE CLEARED 10/30/99 25. OFFENSE TYPE 1. ADULT 2. JUVENILE 3. UNKNOWN

ACTIVATED

39. (CODE S-SUSPECT W-WITNESS V-VICTIM O-OTHER)						
CODE	40. NAME-LAST	FIRST	MI	41. D.O.B.	42. ADDRESS	43. TELEPHONE
0	WILCOX	KEVIN	M		W Cortez Cir #6, Franklin	53132

03/23/99 @ 0745 Hrs.: I, Deputy E. Glaeser, was informed of this anonymous Crime Stopper complaint by Dispatch. The information relayed was that there was a possible vehicle matching the description of our hit and run suspect truck. Information relayed that a party was on his way to work at KOHLER near Sheboygan when he observed a black Chevy pickup truck with right front end damage parked along STH 42 near the ST. VINCENT-DEPAUL STORE in Sheboygan. The anonymous complainant suggested we take a look at the truck for any possible connection with our hit and run.

Dispatch was advised to request SBSO to check the vehicle and make a determination from their preliminary observation on whether or not the vehicle should be investigated further. Dispatch advised the vehicle was displaying WI RP NSA769. A 10-28 was run on this RP. The RPs indicated the vehicle would be a 1986 Chevy truck registered to KEVIN WILCOX. Due to the fact I was working on a warrant pickup with my lieutenant and another officer, I was unable to immediately respond to Sheboygan Co.

Dispatch informed me SBSO checked the vehicle in question. They believe it fits our hit and run suspect description. They requested an officer from MTSO travel to this location and check the vehicle out for ourselves.

03/23/99 @ 0849 Hrs.: I arrived in Sheboygan Co. where I met with SBSO Deputy Olson in regard to this complaint. Deputy Olson told me she was familiar with the WILCOX family. She further stated she did not expect any cooperation from WILCOX or anyone located at this residence in regard to the vehicle. I informed Deputy Olson, if the suspect gave us resistance, we would deal with that when it happened.

A short time later, I was able to observe the vehicle. Immediately upon checking it over, I was able to eliminate it as our hit and run suspect vehicle as the front grill did have chrome and the center cross member was black in color, thus eliminating it from suspicion in our hit and run. Deputy Olson was advised of the physical description of the hit and run grill we were looking for, more specifically the description of vehicles we were looking for. She was further advised to notify MTSO should there be any other vehicles they observe that could match our hit and run description.

CASE # S99 No 02304

45. IF COMPLAINANT DIFFERENT THEN CALLER, ENTER NAME, ADDRESS, D.O.B., TELEPHONE.

46. IF CODE O (OTHER) IS USED IN FIELD #39, EXPLAIN.

INCIDENT REPORT: NOTE: IF SECTION 22 ABOVE HAS NUMBER 4 CHECKED, DO NOT GO BEYOND THIS LINE WITHOUT RECORDS SECTION BEING ADVISED, OR NO RECORD ENTRIES WILL BE MADE BELOW THIS LINE.

PROPERTY VALUE	26. PROPERTY	A. CURRENCY	B. JEWELRY	C. FURS CLOTHING	D. VEHICLE (LOCAL)	E. OFFICE EQUIPMENT	F. RADIO, TV CAMERAS	G. FIREARMS	H. HOUSE-HOLD GOODS
	STOLEN	\$	\$	\$	\$	\$	\$	\$	\$
	RECOVERED	\$	\$	\$	\$	\$	\$	\$	\$
	26. PROPERTY	I. CONSUMABLES	J. LIVESTOCK	K. DRUGS	L. MARINE ITEMS	M. CONSTRUCTION ITEMS	N. LAWN AND GARDEN	O. SPORTING GOODS	P. MISC BICYCLE
STOLEN	\$	\$	\$	\$	\$	\$	\$	\$	
RECOVERED	\$	\$	\$	\$	\$	\$	\$	\$	

27. PROPERTY RECOVERED: LOCALLY ____ OTHER JURISDICTION ____ (INSERT O OR L)

PROPERTY ITEMIZATION	PROPERTY STOLEN/RECOVERED ITEMIZATION, USE THE FOLLOWING FORMAT				
	28. QUANTITY	29. ARTICLE NAME	30. BRAND NAME	31. SERIAL NUMBER	32. CODE
					S <input type="checkbox"/> R <input type="checkbox"/>
					S <input type="checkbox"/> R <input type="checkbox"/>
					S <input type="checkbox"/> R <input type="checkbox"/>
					S <input type="checkbox"/> R <input type="checkbox"/>
					S <input type="checkbox"/> R <input type="checkbox"/>
					S <input type="checkbox"/> R <input type="checkbox"/>

33. PROPERTY DAMAGE AMOUNT \$ _____

34. INSURANCE COMPANY _____

35. OFFICER ASSAULTED Y N

36. ARSON Y N

37. STRUCTURE CODE _____

38. DAMAGE \$ _____

47. CIB ENTERED CANCELLED
 NCIC
 OTHER BROADCAST

48. TOTAL AMOUNT PROPERTY STOLEN \$ _____

49. TOTAL AMOUNT PROPERTY RECOVERED \$ _____

50. IS REPORT CONTINUED? YES NO

51. CAUTION INDICATORS, ATLS ETC.

52. DATA PROCESS INFORMATION:

COMPUTER ENTERED DATE 1/30/99

MICROFILM INDEXED INITIAL KS

IS CASE CLASSIFICATION CORRECT? Y N
 IF N HAS CORRECTION BEEN MADE? Y N

53. FILE APPROVAL

BY 

DATE 03/30/99

1. CASE # S99 No 02308
 2. CLASSIFICATION 6,3|0,1| | 3. CENSUS 5,2|0,0,0

4. INCIDENT CS/S99-00242
 5. INCIDENT LOCATION
 6. NAME- LAST-FIRST-MI Anonymus (2) 7. D.O.B.
 8. ADDRESS
 9. TX-HOME
 10. TX-BUSINESS
 11. CITY STATE ZIP
 12. [Redacted] is a subject by the nickname of "Hippe"
 owns a multi colored junky Suburban. He
 lives 3-4 houses east of cpl's residence
 at [Redacted]

03-23-99 1015

14. REC'D	15. DISP	16. 10-23	17. 10-24
13. DAY			
SUN 1	THU 5		
MON 2	FRI 6		
TUE 3	SAT 7		
WED 4			

MANITOWOC COUNTY SHERIFF
 INCIDENT CARD

18. ASSIGNED MTSO 9/6/99

19. REC. BY 901 20. DIS. BY ---

21. HOW REC'D.
 1. 911
 2. POLICE RADIO
 3. PHONE
 4. TTY
 5. IN PERSON
 6. ON VIEW
 7. OFF. OFF DUTY
 8. C.B. RADIO
 9. OTHER
 21A. M.O.

22. TYPE OF REPORT
 1. INCIDENT
 2. ACCIDENT
 3. CITATION
 4. NONE

23. STATUS
 1. UNFOUNDED
 2. PNL
 3. OTHER
 4. CLEARED
 5. EXCEPT CLEARED

24. DATE CLEARED 06/01/99

25. OFFENSE TYPE
 1. ADULT NA
 2. JUVENILE
 3. UNKNOWN

39. (CODE S-SUSPECT W-WITNESS V-VICTIM O-OTHER) CODE	40. NAME-LAST FIRST MI	41. D.O.B.	42. ADDRESS	43. TELEPHO
O	Ludwig, Dion M. 10/16/52	[Redacted]	[Redacted] W. Marshal, Mtwc	

03/24/99 2025hrs Contact attempted at the Crime Stoppers Complainant residence as he did not leave a phone number. Lights on in basement only, no one came to the door. The address he talking about is East approximately five residences North side. Two vehicles in the yard at this time TNN 520 Aut and BH 28186 Trk. No one at the residence at this time tracks on the lawn indicated possibly two other vehicles park there. House formerly owned by Myron Ahrens Jr. address [Redacted] West Marshall. I will check back after bar closing. I have been to this residence once before to check on a Blazer and Suburban, neither vehicle there now. M.J. Bushman

03/25/99 1930hrs attempted contact with resident at [Redacted]. The woman answering the door stated no one in the house filed a CrimesStopper report and then asked how long ago it was filed. She stated if it was over a week that party had moved out. New address was obtained and contact made on South side of the city. She wishes to remain anonymous. She has no specific information which leads her to believe this party is the suspect other than he drinks alot and drives a multi colored Chev Blazer. No remarks have been made, no hidden vehicle she knows about, just that he drinks alot and the type vehicle we're looking for. His truck had been checked twice before while in his driveway by Lt. Bushman and while parked at Knuckleheads on Calumet Ave. by Sgt. Janssen.

On one of the drivebys there were several vehicles similar to suspect vehicle, more leg work required. M.J. Bushman

03/30/99 After Bar Closing late night checks are being made and to date these are the vehicle plates observed in the [Redacted] W. Marshal property: RH 28186, TNN 520, AH 77746, (comes back on a 90 Toyota, is on an older Chev. Suburban w/o an engine parked in driveway) An earlier complaint S99-01523 dealt with an 88 Chev. Blazer also at that property owned by Thomas Drexler and is now back at his residence [Redacted] E. Albert Dr. #58 Mtwc. M.J. Bushman

05/07/99 Nothing further at this time, close out. M.J. Bushman

S99 No 02308

45. IF COMPLAINANT DIFFERENT THEN CALLER, ENTER NAME, ADDRESS, D.O.B., TELEPHONE.

46. IF CODE O (OTHER) IS USED IN FIELD #39, EXPLAIN.

INCIDENT REPORT: NOTE: IF SECTION 22 ABOVE HAS NUMBER 4 CHECKED, DO NOT GO BEYOND THIS LINE WITHOUT RECORDS SECTION BEING ADVISED, OR NO RECORD ENTRIES WILL BE MADE BELOW THIS LINE

PROPERTY VALUE	26. PROPERTY	A. CURRENCY	B. JEWELRY	C. FURS CLOTHING	D. VEHICLE (LOCAL)	E. OFFICE EQUIPMENT	F. RADIO, TV CAMERAS	G. FIREARMS	H. HOUSE-HOLD GOODS
	STOLEN	\$	\$	\$	\$	\$	\$	\$	\$
	RECOVERED	\$	\$	\$	\$	\$	\$	\$	\$
	26. PROPERTY	I. CONSUMABLES	J. LIVESTOCK	K. DRUGS	L. MARINE ITEMS	M. CONSTRUCTION ITEMS	N. LAWN AND GARDEN	O. SPORTING GOODS	P. MISC BICYCLE
	STOLEN	\$	\$	\$	\$	\$	\$	\$	\$
	RECOVERED	\$	\$	\$	\$	\$	\$	\$	\$

27. PROPERTY RECOVERED: LOCALLY _____ OTHER JURISDICTION _____ (INSERT O OR L)

PROPERTY ITEMIZATION	PROPERTY STOLEN/RECOVERED ITEMIZATION, USE THE FOLLOWING FORMAT				
	28. QUANTITY	29. ARTICLE NAME	30. BRAND NAME	31. SERIAL NUMBER	
					S <input type="checkbox"/> R <input type="checkbox"/>
					S <input type="checkbox"/> R <input type="checkbox"/>
					S <input type="checkbox"/> R <input type="checkbox"/>
					S <input type="checkbox"/> R <input type="checkbox"/>
					S <input type="checkbox"/> R <input type="checkbox"/>

33. PROPERTY DAMAGE AMOUNT \$ _____ 34. INSURANCE COMPANY _____

35. OFFICER ASSAULTED Y N 36. ARSON Y N 37. STRUCTURE CODE _____ 38. DAMAGE \$ _____

47. CIB	ENTERED <input type="checkbox"/>	CANCELLED <input type="checkbox"/>	48. TOTAL AMOUNT PROPERTY STOLEN \$ _____
NCIC	<input type="checkbox"/>	<input type="checkbox"/>	
OTHER BROADCAST	<input type="checkbox"/>	<input type="checkbox"/>	
			49. TOTAL AMOUNT PROPERTY RECOVERED \$ _____

50. IS REPORT CONTINUED? YES NO 51. CAUTION INDICATORS, ATLS ETC.

52. DATA PROCESS INFORMATION:

COMPUTER ENTERED DATE 10 29 99

MICROFILM INDEXED INITIAL KS

IS CASE CLASSIFICATION CORRECT? IF N HAS CORRECTION BEEN MADE? Y N

53. FILE APPROVAL

BY [Signature] DATE 10 29 99

1. CASE # S99 No 02342 2. CLASSIFICATION 63101 3. CENSUS 701000

4. INCIDENT CS/SR 00242

5. INCIDENT LOCATION

6. NAME MISCUS (2) 7. D.O.B.

8. ADDRESS 9. TX-HOME

11. CITY STATE ZIP 10. TX-BUSINESS

12. DETAILS
 REPORTS SEEING CHEV PUL LIGHT
 BLUE, FRONT END DAMAGE, UNABLE
 TO OBTAIN PLATE. LAST SEEN NORTH ON
 AKD 67 FROM PLYMOUTH

04-24-99 1456
 657-P.H.O
 14. REC'D 15. DISP 16. 10-23 17. 10-24
 13. DAY
 SUN 1 THU 5
 MON 2 FRI 6
 TUE 3 SAT 7
 WED 4

MANITOWOC COUNTY SHERIFF
INCIDENT CARD

18. ASSIGNED M750 9/2/99

19. REC. BY 20. DIS. BY
 939

21. HOW REC'D.
 1. 911
 2. POLICE RADIO
 3. PHONE
 4. TTY
 5. IN PERSON
 6. ON VIEW
 7. OFF. OFF DUTY
 8. C.B. RADIO
 9. OTHER

22. TYPE OF REPORT
 1. INCIDENT
 2. ACCIDENT
 3. CITATION
 4. NONE

23. STATUS
 1. UNFOUNDED
 2. PNL
 3. OTHER
 4. CLEARED
 5. EXCEPT CLEARED

24. DATE CLEARED 10/20/99
 25. OFFENSE TYPE
 1. ADULT NA
 2. JUVENILE
 3. UNKNOWN

39. (CODE S-SUSPECT W-WITNESS V-VICTIM O-OTHER)

CODE	40. NAME-LAST	FIRST	MI	41. D.O.B.	42. ADDRESS	43. TELEPHONE

03/24/99 1900hrs. Plymouth PD phoned and information passed on for road call. TTY was sent at the time the report was taken. M.J. Bushman
 04/16/99 Vehicle not located, Close out. M.J. Bushman

45. IF COMPLAINANT DIFFERENT THEN CALLER, ENTER NAME, ADDRESS, D.O.B., TELEPHONE.

46. IF CODE O (OTHER) IS USED IN FIELD #39, EXPLAIN.

INCIDENT REPORT: NOTE: IF SECTION 22 ABOVE HAS NUMBER 4 CHECKED, DO NOT GO BEYOND THIS LINE WITHOUT RECORDS SECTION BEING ADVISED, OR NO RECORD ENTRIES WILL BE MADE BELOW THIS LINE.

P R O P E R T Y V A L U E	26. PROPERTY	A. CURRENCY	B. JEWELRY	C. FURS CLOTHING	D. VEHICLE (LOCAL)	E. OFFICE EQUIPMENT	F. RADIO, TV CAMERAS	G. FIREARMS	H. HOUSE-HOLD GOODS
	STOLEN	\$	\$	\$	\$	\$	\$	\$	\$
	RECOVERED	\$	\$	\$	\$	\$	\$	\$	\$
	26. PROPERTY	I. CONSUMABLES	J. LIVESTOCK	K. DRUGS	L. MARINE ITEMS	M. CONSTRUCTION ITEMS	N. LAWN AND GARDEN	O. SPORTING GOODS	P. MISC BICYCLE
STOLEN	\$	\$	\$	\$	\$	\$	\$	\$	
RECOVERED	\$	\$	\$	\$	\$	\$	\$	\$	

27. PROPERTY RECOVERED: LOCALLY _____ OTHER JURISDICTION _____ (INSERT O OR L)

P R O P E R T Y I T E M I Z A T I O N	PROPERTY STOLEN/RECOVERED ITEMIZATION, USE THE FOLLOWING FORMAT			
	28. QUANTITY	29. ARTICLE NAME	30. BRAND NAME	31. SERIAL NUMBER

33. PROPERTY DAMAGE AMOUNT \$ _____ 34. INSURANCE COMPANY _____

35. OFFICER ASSAULTED Y N 36. ARSON Y N 37. STRUCTURE CODE _____ 38. DAMAGE \$ _____

47. CIB ENTERED CANCELLED
 NCIC
 OTHER BROADCAST

48. TOTAL AMOUNT PROPERTY STOLEN \$ _____

49. TOTAL AMOUNT PROPERTY RECOVERED \$ _____

50. IS REPORT CONTINUED? YES NO

51. CAUTION INDICATORS, ATLS ETC.

52. DATA PROCESS INFORMATION:

COMPUTER ENTERED DATE 6/29/99
 MICROFILM INDEXED INITIAL AS

53. FILE APPROVAL

IS CASE CLASSIFICATION CORRECT? Y N
 IF N HAS CORRECTION BEEN MADE? Y N

BY gmx DATE 04/20/99

1. CASE # **S99 No 02385** | 2. CLASSIFICATION **6,310,1** | 3. CENSUS **6,0000**

4. INCIDENT **CS/S99-00242**

5. INCIDENT LOCATION **New Holstein/Kiel area**

6. LAST-FIRST-MI **ANONY** | 7. D.O.B.

8. ADDRESS | 9. TX-HOME

11. CITY STATE ZIP | 10. TX-BUSINESS

12. DETAILS
Robt. Niessen, who is a police officer, and lives in the New Holstein/Kiel area, used to drive a bluish gray Chev Blazer and now drives a newer truck. Unk. if the Blazer had any damage. Unk. where Niessen lives exactly.

3/26/99 09:00

MANITOWOC COUNTY SHERIFF INCIDENT CARD

18. ASSIGNED **MTSC 9219**

19. REC. BY **9:50** | 20. DIS. BY

21. HOW REC'D. **3. PHONE**

22. TYPE OF REPORT
 1. INCIDENT
 2. ACCIDENT
 3. CITATION
 4. NONE

23. STATUS
 1. UNFOUNDED
 2. PNL
 3. OTHER
 4. CLEARED
 5. EXCEPT CLEARED

24. DATE CLEARED **10/12/99**

25. OFFENSE TYPE
 1. ADULT NA
 2. JUVENILE
 3. UNKNOWN

13. DAY
 SUN 1 THU 5
 MON 2 **FRI 6**
 TUE 3 SAT 7
 WED 4

39. (CODE S-SUSPECT W-WITNESS V-VICTIM O-OTHER)	40. NAME-LAST	FIRST	MI	41. D.O.B.	42. ADDRESS	43. TELEPHONE
0	Niessen, Robert J.				CTH J New Holstein	
	Chuck Van Horn				Plymouth	

03/29/99 Robert J. Niessen is a full time police officer for the city of New Holstein. He was on duty when I called at 2230hrs and returned my call when he arrived in the office. He had owned a 1986 GMC Jimmy Blue-Gray in color trading it off on a 1997 Dodge Dakota in Plymouth at the Chuck Van Horn Doge dealership 12/30/98. Vehicle did not have any damage at the time of the trade which would have been 12 days before the Hit&Run accident.

M.J. Bushman

03/30/99 1454hrs Contact made by phone with Sales Manager Brett Goebel. He recalled off the top of his head this deal was made just before the first of the year. He then checked the "Deal Jacket" hard copy records file and noted the 1997 Doge Dakota was delivered to Niessen 12/30/98. He took possession of the new vehicle at that time surrendering his 86 GMC Jimmy to Van Horn. Goebel could not recall if there was damage and nothing appeared on the transaction report, besides this was 12 days prior to our Hit&Run. Close out complaint.

ENTERED ETC

M.J. Bushman

45. IF COMPLAINANT DIFFERENT THEN CALLER, ENTER NAME, ADDRESS, D.O.B., TELEPHONE.

46. IF CODE O (OTHER) IS USED IN FIELD #39, EXPLAIN.

INCIDENT REPORT: NOTE: IF SECTION 22 ABOVE HAS NUMBER 4 CHECKED, DO NOT GO BEYOND THIS LINE WITHOUT RECORDS SECTION BEING ADVISED, OR NO RECORD ENTRIES WILL BE MADE BELOW THIS LINE.

PROPERTY VALUE	26. PROPERTY	A. CURRENCY	B. JEWELRY	C. FURS CLOTHING	D. VEHICLE (LOCAL)	E. OFFICE EQUIPMENT	F. RADIO, TV CAMERAS	G. FIREARMS	H. HOUSE-HOLD GOODS
	STOLEN	\$	\$	\$	\$	\$	\$	\$	\$
	RECOVERED	\$	\$	\$	\$	\$	\$	\$	\$
	26. PROPERTY	I. CONSUMABLES	J. LIVESTOCK	K. DRUGS	L. MARINE ITEMS	M. CONSTRUCTION ITEMS	N. LAWN AND GARDEN	O. SPORTING GOODS	P. MISC BICYCLE
	STOLEN	\$	\$	\$	\$	\$	\$	\$	\$
	RECOVERED	\$	\$	\$	\$	\$	\$	\$	\$

27. PROPERTY RECOVERED: LOCALLY _____ OTHER JURISDICTION _____ (INSERT O OR L)

PROPERTY ITEMIZATION	PROPERTY STOLEN/RECOVERED ITEMIZATION, USE THE FOLLOWING FORMAT				
	28. QUANTITY	29. ARTICLE NAME	30. BRAND NAME	31. SERIAL NUMBER	32. CODE
					S R <input type="checkbox"/> <input type="checkbox"/>
					S R <input type="checkbox"/> <input type="checkbox"/>
					S R <input type="checkbox"/> <input type="checkbox"/>
					S R <input type="checkbox"/> <input type="checkbox"/>

33. PROPERTY DAMAGE AMOUNT \$ _____ 34. INSURANCE COMPANY _____

35. OFFICER ASSAULTED Y N 36. ARSON Y N 37. STRUCTURE CODE _____ 38. DAMAGE \$ _____

47. CIB	ENTERED <input type="checkbox"/>	CANCELLED <input type="checkbox"/>	48. TOTAL AMOUNT PROPERTY STOLEN \$ _____
NCIC	<input type="checkbox"/>	<input type="checkbox"/>	
OTHER BROADCAST	<input type="checkbox"/>	<input type="checkbox"/>	
			49. TOTAL AMOUNT PROPERTY RECOVERED \$ _____

50. IS REPORT CONTINUED? YES NO 51. CAUTION INDICATORS, ATLS ETC.

52. DATA PROCESS INFORMATION:

COMPUTER ENTERED DATE 10 29 99

MICROFILM INDEXED INITIAL KS

IS CASE CLASSIFICATION CORRECT? Y N

IF N HAS CORRECTION BEEN MADE? Y N

53. FILE APPROVAL

BY JK DATE 10 4 1999

1. CASE # S99 No 02357
 2. CLASSIFICATION 6,3|0,1| | , 5,2 0 0 0
 3. CENSUS

REPORT
 7599-00242
 INCIDENT LOCATION

6. NAME FIRST-MI
 Anonymous (2) 7. D.O.B.

8. ADDRESS 9. TX-HOME
 11. CITY STATE ZIP 10. TX-BUSINESS

12. DETAILS
 received a call that a Chev Suburban, plate
 TBG669 has front grill and hood damage
 to it. Caller would have seen it about a
 week ago at the bar HAWK NEST In Kaukauna

March 24, 1999 2307

14. REC'D
 15. DISP
 16. 10-23
 17. 10-24
 13. DAY
 SUN 1 THU 5
 MON 2 FRI 6
 TUE 3 SAT 7
 WED 4

MANITOWOC COUNTY SHERIFF
 INCIDENT CARD

18. ASSIGNED

19. REC. BY 20. DIS. BY
 924

21. HOW REC'D.
 1. 911
 2. POLICE RADIO
 3. PHONE
 4. TTY
 5. IN PERSON
 6. ON VIEW
 7. OFF. OFF DUTY
 8. C.B. RADIO
 9. OTHER
 21A.M.O.

22. TYPE OF REPORT
 1. INCIDENT
 2. ACCIDENT
 3. CITATION
 4. NONE

23. STATUS
 1. UNFOUNDED
 2. PNL
 3. OTHER
 4. CLEARED
 5. EXCEPT CLEARED

24. DATE CLEARED 04/12/99

25. OFFENSE TYPE
 1. ADULT NA
 2. JUVENILE
 3. UNKNOWN

MANITOWOC COUNTY SHERIFF

39. (CODE S-SUSPECT W-WITNESS V-VICTIM O-OTHER)

CODE	40. NAME-LAST	FIRST	MI	41. D.O.B.	42. ADDRESS	43. TELEPHONE
O	Verbeten, John R.	84582			Melrose Ct. Little Chute	
	Fox Valley Metro				W. McKinley, Little Chute	

03/24/99 John Verbeten was the suspect in a previous followup complaint # S99-01971. Fox Valley Metro Complaint #990029546 Thursday 03/11/99 1545hrs assisted and forwarded the complaint copy with pictures. Close Out. M.J. Bushman

ALREADY ENTERED ETC

45. IF COMPLAINANT DIFFERENT THEN CALLER, ENTER NAME, ADDRESS, D.O.B., TELEPHONE.

46. IF CODE O (OTHER) IS USED IN FIELD #39, EXPLAIN.

INCIDENT REPORT: NOTE: IF SECTION 22 ABOVE HAS NUMBER 4 CHECKED, DO NOT GO BEYOND THIS LINE WITHOUT RECORDS SECTION BEING ADVISED, OR NO RECORD ENTRIES WILL BE MADE BELOW THIS LINE.

PROPERTY VALUE	26. PROPERTY	A. CURRENCY	B. JEWELRY	C. FURS CLOTHING	D. VEHICLE (LOCAL)	E. OFFICE EQUIPMENT	F. RADIO, TV CAMERAS	G. FIREARMS	H. HOUSE-HOLD GOODS
	STOLEN	\$	\$	\$	\$	\$	\$	\$	\$
	RECOVERED	\$	\$	\$	\$	\$	\$	\$	\$
	26. PROPERTY	I. CONSUMABLES	J. LIVESTOCK	K. DRUGS	L. MARINE ITEMS	M. CONSTRUCTION ITEMS	N. LAWN AND GARDEN	O. SPORTING GOODS	P. MISC BICYCLE
	STOLEN	\$	\$	\$	\$	\$	\$	\$	\$
	RECOVERED	\$	\$	\$	\$	\$	\$	\$	\$

27. PROPERTY RECOVERED: LOCALLY _____ OTHER JURISDICTION _____ (INSERT O OR L)

PROPERTY ITEMIZATION	28. QUANTITY	29. ARTICLE NAME	30. BRAND NAME	31. SERIAL NUMBER	32. CODE	
					S	R
					<input type="checkbox"/>	<input type="checkbox"/>
					S	R
					<input type="checkbox"/>	<input type="checkbox"/>
					S	R
					<input type="checkbox"/>	<input type="checkbox"/>

33. PROPERTY DAMAGE AMOUNT \$ _____

34. INSURANCE COMPANY _____

35. OFFICER ASSAULTED Y N

36. ARSON Y N

37. STRUCTURE CODE _____

38. DAMAGE \$ _____

47. CIB ENTERED CANCELLED
 NCIC
 OTHER BROADCAST

48. TOTAL AMOUNT PROPERTY STOLEN \$ _____

49. TOTAL AMOUNT PROPERTY RECOVERED \$ _____

50. IS REPORT CONTINUED? YES NO

51. CAUTION INDICATORS, ATLS ETC.

52. DATA PROCESS INFORMATION:

COMPUTER ENTERED DATE 16 2 99
 MICROFILM INDEXED INITIAL RS

53. FILE APPROVAL

IS CASE CLASSIFICATION CORRECT? Y N
 IF N HAS CORRECTION BEEN MADE? Y N

BY OK DATE 10 4 12 99

1. CASE # S99 No 02392 | 2. CLASSIFICATION 6.310.11 | 3. CENSUS 5,210.00

4. INCIDENT CS/S99-00242

5. INCIDENT LOCATION BIK Division St.

7. D.O.B. 9476

9. TX-HOME [REDACTED]

10. TX-BUSINESS [REDACTED]

STATE ZIP

Sited possible H+R vehicle
this morning.

1100

3-26-99

14. REC'D. 15. DISP 16. 10-23 17. 10-24

13. DAY
SUN 1 THU 5
MON 2 FRI 6
TUE 3 SAT 7
WED 4

MANITOWOC COUNTY SHERIFF
INCIDENT CARD

18. ASSIGNED Information 9811

19. REC. BY 941 | 20. DIS. BY

21. HOW REC'D.
1. 911
2. POLICE RADIO
3. PHONE
4. TTY
5. IN PERSON
6. ON VIEW
7. OFF. OFF DUTY
8. C.B. RADIO
9. OTHER

22. TYPE OF REPORT
1. INCIDENT
2. ACCIDENT
3. CITATION
4. NONE

23. STATUS
1. UNFOUNDED
2. PNL
3. OTHER
4. CLEARED
5. EXCEPT CLEARED

24. DATE CLEARED 04/12/99

25. OFFENSE TYPE
1. ADULT NA
2. JUVENILE
3. UNKNOWN

21A. M.O.

39. (CODE S-SUSPECT W-WITNESS V-VICTIM O-OTHER)

CODE	40. NAME-LAST	FIRST	MI	41. D.O.B.	42. ADDRESS	43. TELEPHONE
O	Swoboda, Terry M	34397		[REDACTED]	[REDACTED] S.21st Street, Mtwc	
O	Gagner, Gary J.	5941		[REDACTED]	[REDACTED] Taylor St., Two Rivers	[REDACTED]

03/29/99 2105hrs Dispatch ran ten plates filling in the missing last digit AE2128 1-0, as provided by the Crime Stopper report.
 AE 21284 comes back to Terry Swoboda listed above and was checked on a previous complaint S99-00332.
 AE 21289 comes back to Gary Gagner listed above. It has not been checked according to our records and shift commander Brotski in Two Rivers agreed to send a squad after briefing. Attempted phone contact with Gagner residence, no answer. M.J. Bushman
 2210hrs Two Rivers Off. did a check of the residence. No truck fitting the 10-28 was visible from the street. There is a three car garage with moving sensor lights and several dogs in neighborhood. No lights on in residence, contact was not attempted. The complaint will be passed on to a day shift for followup. M.J. Bushman
 03/30/99 Day shift at TRPD completed the vehicle check as requested. Officer Skrzyckie reports the vehicle had no fresh damage consistent with what we are looking for in the Hit&Run accident suspect. Close out. M.J. Bushman
 ENTER ETC

S99 No 02392

45. IF COMPLAINANT DIFFERENT THEN CALLER, ENTER NAME, ADDRESS, D.O.B., TELEPHONE.

46. IF CODE O (OTHER) IS USED IN FIELD #39, EXPLAIN.

INCIDENT REPORT: NOTE: IF SECTION 22 ABOVE HAS NUMBER 4 CHECKED, DO NOT GO BEYOND THIS LINE WITHOUT RECORDS SECTION BEING ADVISED, OR NO RECORD ENTRIES WILL BE MADE BELOW THIS LINE.

PROPERTY VALUE	26. PROPERTY	A. CURRENCY	B. JEWELRY	C. FURS CLOTHING	D. VEHICLE (LOCAL)	E. OFFICE EQUIPMENT	F. RADIO, TV CAMERAS	G. FIREARMS	H. HOUSE-HOLD GOODS
	STOLEN	\$	\$	\$	\$	\$	\$	\$	\$
	RECOVERED	\$	\$	\$	\$	\$	\$	\$	\$
	26. PROPERTY	I. CONSUMABLES	J. LIVESTOCK	K. DRUGS	L. MARINE ITEMS	M. CONSTRUCTION ITEMS	N. LAWN AND GARDEN	O. SPORTING GOODS	P. MISC BICYCLE
	STOLEN	\$	\$	\$	\$	\$	\$	\$	\$
	RECOVERED	\$	\$	\$	\$	\$	\$	\$	\$

27. PROPERTY RECOVERED: LOCALLY ____ OTHER JURISDICTION ____ (INSERT O OR L)

PROPERTY ITEMIZATION	PROPERTY STOLEN/RECOVERED ITEMIZATION, USE THE FOLLOWING FORMAT			
	28. QUANTITY	29. ARTICLE NAME	30. BRAND NAME	31. SERIAL NUMBER
				32. CODE S <input type="checkbox"/> R <input type="checkbox"/>
				S <input type="checkbox"/> R <input type="checkbox"/>
				S <input type="checkbox"/> R <input type="checkbox"/>
				S <input type="checkbox"/> R <input type="checkbox"/>
				S <input type="checkbox"/> R <input type="checkbox"/>
				S <input type="checkbox"/> R <input type="checkbox"/>

33. PROPERTY DAMAGE AMOUNT \$ _____

34. INSURANCE COMPANY _____

35. OFFICER ASSAULTED Y N

36. ARSON Y N

37. STRUCTURE CODE _____

38. DAMAGE \$ _____

47. CIB ENTERED CANCELLED
 NCIC
 OTHER BROADCAST

48. TOTAL AMOUNT PROPERTY STOLEN \$ _____

49. TOTAL AMOUNT PROPERTY RECOVERED \$ _____

50. IS REPORT CONTINUED? YES NO

51. CAUTION INDICATORS, ATLS ETC.

52. DATA PROCESS INFORMATION:

COMPUTER ENTERED DATE 10/29/99
 MICROFILM INDEXED INITIAL AS

IS CASE CLASSIFICATION CORRECT?
 IF N HAS CORRECTION BEEN MADE? Y N

53. FILE APPROVAL

BY AK

DATE 10/12/99

Dear Lt. Bushman,

veh @ ■ Taylor
was chid & ruled out by
Officer Skrzycki. Had no
fresh damage

Love,

Lt. Brotski

1. CASE # S99 No 02395 2. CLASSIFICATION 6310.11 3. CENSUS 52600

4. INCIDENT CS/S99-00242

5. INCIDENT LOCATION N. 6th St., Mtwc

6. NAME - LAST - FIRST - MI Army 7. D.O.B.

8. ADDRESS 9. TX-HOME

11. CITY STATE ZIP 10. TX-BUSINESS

12. DETAILS
 White Blazer w/no grill
 is parked on N. 6th St.
 Reg. MJX 417

3/26/99 1151

14. REC'D	15. DISP	16. 10-23	17. 10-24
13. DAY			
SUN 1	THU 5		
MON 2	FRI 6		
TUE 3	SAT 7		
WED 4			

MANITOWOC COUNTY SHERIFF
INCIDENT CARD

18. ASSIGNED MTSO 9219

19. REC. BY 20. DIS. BY
 22. TYPE OF REPORT
 1. INCIDENT
 2. ACCIDENT
 3. CITATION
 4. NONE

21. HOW REC'D.
 1. 911
 2. POLICE RADIO
 3. PHONE
 4. TTY
 5. IN PERSON
 6. ON VIEW
 7. OFF. OFF DUTY
 8. C.B. RADIO
 9. OTHER
 23. STATUS
 1. UNFOUNDED
 2. PNL
 3. OTHER
 4. CLEARED
 5. EXCEPT CLEARED

24. DATE CLEARED 10/4/99
 25. OFFENSE TYPE
 1. ADULT NA
 2. JUVENILE
 3. UNKNOWN

39. (CODE S-SUSPECT W-WITNESS V-VICTIM O-OTHER)						
CODE	40. NAME-LAST	FIRST	MI	41. D.O.B.	42. ADDRESS	43. TELEPHONE
0	Duellman, Jess E.	09684			Easy St., Mtwc	

03/30/99 This vehicle has been checked before Complaint # S99-02125 Close. M.J. Bushman
 ENTERED ETC

45. IF COMPLAINANT DIFFERENT THEN CALLER, ENTER NAME, ADDRESS, D.O.B., TELEPHONE.

46. IF CODE O (OTHER) IS USED IN FIELD #39, EXPLAIN.

INCIDENT REPORT: NOTE: IF SECTION 22 ABOVE HAS NUMBER 4 CHECKED, DO NOT GO BEYOND THIS LINE WITHOUT RECORDS SECTION BEING ADVISED, OR NO RECORD ENTRIES WILL BE MADE BELOW THIS LINE.

PROPERTY VALUE	26. PROPERTY	A. CURRENCY	B. JEWELRY	C. FURS CLOTHING	D. VEHICLE (LOCAL)	E. OFFICE EQUIPMENT	F. RADIO, TV CAMERAS	G. FIREARMS	H. HOUSE-HOLD GOODS
	STOLEN	\$	\$	\$	\$	\$	\$	\$	\$
	RECOVERED	\$	\$	\$	\$	\$	\$	\$	\$
	26. PROPERTY	I. CONSUM-ABLES	J. LIVESTOCK	K. DRUGS	L. MARINE ITEMS	M. CONSTRUCTION ITEMS	N. LAWN AND GARDEN	O. SPORTING GOODS	P. MISC BICYCLE
	STOLEN	\$	\$	\$	\$	\$	\$	\$	\$
	RECOVERED	\$	\$	\$	\$	\$	\$	\$	\$

27. PROPERTY RECOVERED: LOCALLY ____ OTHER JURISDICTION ____ (INSERT O OR L)

PROPERTY ITEMIZATION	PROPERTY STOLEN/RECOVERED ITEMIZATION, USE THE FOLLOWING FORMAT			
	28. QUANTITY	29. ARTICLE NAME	30. BRAND NAME	31. SERIAL NUMBER

33. PROPERTY DAMAGE AMOUNT \$ _____ 34. INSURANCE COMPANY _____

35. OFFICER ASSAULTED Y N 36. ARSON Y N 37. STRUCTURE CODE _____ 38. DAMAGE \$ _____

47. CIB	ENTERED <input type="checkbox"/>	CANCELLED <input type="checkbox"/>	48. TOTAL AMOUNT PROPERTY STOLEN \$ _____
NCIC	<input type="checkbox"/>	<input type="checkbox"/>	
OTHER BROADCAST	<input type="checkbox"/>	<input type="checkbox"/>	
			49. TOTAL AMOUNT PROPERTY RECOVERED \$ _____

50. IS REPORT CONTINUED? YES NO 51. CAUTION INDICATORS, ATLS ETC.

52. DATA PROCESS INFORMATION:

COMPUTER ENTERED DATE 11/29/99

MICROFILM INDEXED INITIAL KS

IS CASE CLASSIFICATION CORRECT? Y N

IF N HAS CORRECTION BEEN MADE? Y N

53. FILE APPROVAL

BY [Signature] DATE 04/12/99

1. CASE # S99 02404	2. CLASSIFICATION 6,310,11	3. CENSUS 1,410,0,2
4. INCIDENT CS/S99-00242		
5. INCIDENT LOCATION Cth Cl		
6. NAME - LAST-FIRST-MI [REDACTED]		7. D.O.B. [REDACTED]
8. ADDRESS [REDACTED]		9. TX-HOME [REDACTED]
STATE ZIP [REDACTED]		10. TX-BUSINESS [REDACTED]
12. DETAILS REPORTS HE PURCHASED A 1980 VAN FROM KENNETH KNAPP. GRILLE HAS BEEN REPLACED. FOUND BLUE MATERIAL + HAIR UNDERNEATH.		

1557
 3-26-99
 REC'D 14
 15. DISP
 16. 10-23
 17. 10-24
 13. DAY
 SUN 1 THU 5
 MON 2 FRI (6)
 TUE 3 SAT 7
 WED 4

MANITOWOC COUNTY SHERIFF INCIDENT CARD		
18. ASSIGNED		
JOST		41419
BUSHMAN		41411
19. REC. BY G32	20. DIS. BY 436	22. TYPE OF REPORT <input checked="" type="checkbox"/> INCIDENT <input type="checkbox"/> ACCIDENT <input type="checkbox"/> CITATION <input type="checkbox"/> NONE
21. HOW REC'D. <input type="checkbox"/> 1. 911 <input checked="" type="checkbox"/> 2. POLICE RADIO <input checked="" type="checkbox"/> 3. PHONE <input type="checkbox"/> 4. TTY <input type="checkbox"/> 5. IN PERSON <input type="checkbox"/> 6. ON VIEW <input type="checkbox"/> 7. OFF. OFF DUTY <input type="checkbox"/> 8. C.B. RADIO <input type="checkbox"/> 9. OTHER		23. STATUS <input type="checkbox"/> 1. UNFOUNDED <input type="checkbox"/> 2. PNL <input checked="" type="checkbox"/> 3. OTHER <input type="checkbox"/> 4. CLEARED <input type="checkbox"/> 5. EXCEPT CLEARED
21A. M.O.		24. DATE CLEARED 10/20/99
		25. OFFENSE TYPE <input type="checkbox"/> 1. ADULT NA <input type="checkbox"/> 2. JUVENILE <input type="checkbox"/> 3. UNKNOWN

39. (CODE S-SUSPECT W-WITNESS V-VICTIM O-OTHER)	40. NAME-LAST	FIRST	MI	41. D.O.B.	42. ADDRESS	43. TELEPHONE
0	[REDACTED]	[REDACTED]	[REDACTED]	[REDACTED]	[REDACTED]	[REDACTED]
0	KNAPP	KENNETH	D	[REDACTED]	19th St, Two Rivers	[REDACTED]
0	LANE	DALE	E	[REDACTED]	16th St, Two Rivers	[REDACTED]
0	PULS	MELISSA	A	[REDACTED]	24th St, Two Rivers	[REDACTED]

03/26/99 @ 1557 Hrs.: Lt. Thorrington spoke with [REDACTED] who responded to MTSO. [REDACTED] informed Lt. Thorrington that he just purchased a van from KENNETH KNAPP. As he was scraping some grease and mud and things from underneath the van, he found what he believes to be hair fibers and also some possible clothing fibers.

I, Deputy Jost, made contact with [REDACTED] in the Supervisor's Office and looked at the small sandwich plastic baggy which he had. Inside, I observed approximately 8 strands of material which appeared to be some type of hair, a piece or 2 of it possibly being clothing fibers. I took this item into my possession. It was placed into gun locker #7 just outside the Patrol Division report room area. This is a secured locker, and the key was kept in my possession until it was later placed in the Temporary Evidence Room, locker #29.

I told [REDACTED] to respond back out to his residence to make sure nobody did anything with the van until I could respond to the location. After gathering some evidence bags and the Polaroid camera, I responded to [REDACTED] where the van was located.

Upon inspecting the van, it initially did not appear to be the van we were looking for due to the fact it was a 1980 model Chevy van. Upon inspecting it further, however, I saw the headlight assembly and grill assembly was not the same as what is supposed to be on a 1980 Chevy van. The grill had obviously been replaced as the headlights which were mounted in the van were circular in shape and the headlight molding area had a rectangular or square-shaped molding piece. Upon further inspecting the van, specifically under the hood, I observed it appeared as though the small metal fan guard was not the original piece of material which was used as the guard. (I later asked MICHAEL KNORR from HI-WAY 42 GARAGE about the fan guard. He told me also that it should have been a plastic fan guard on that model van.) In further inspecting the truck, I saw there was some damage to the grill which was now in the van, and there were some minor dents on the hood.

Due to all this information, I spoke with Lt. Thorrington. A decision was made to bring the van to MTSO and store it in the South Garage until further information could be determined. Deputy Colborn, an evidence technician, responded to the scene along with Hi-Way 42 Garage with the assistance of Deputy L. Bushman.

S99 No 02404

45. IF COMPLAINANT DIFFERENT THEN CALLER, ENTER NAME, ADDRESS, D.O.B., TELEPHONE.

46. IF CODE O (OTHER) IS USED IN FIELD #39, EXPLAIN.

INCIDENT REPORT: NOTE: IF SECTION 22 ABOVE HAS NUMBER 4 CHECKED, DO NOT GO BEYOND THIS LINE WITHOUT RECORDS SECTION BEING ADVISED, OR NO RECORD ENTRIES WILL BE MADE BELOW THIS LINE.

PROPERTY VALUE	26. PROPERTY	A. CURRENCY	B. JEWELRY	C. FURS CLOTHING	D. VEHICLE (LOCAL)	E. OFFICE EQUIPMENT	F. RADIO, TV CAMERAS	G. FIREARMS	H. HOUSE-HOLD GOODS
	STOLEN	\$	\$	\$	\$	\$	\$	\$	\$
	RECOVERED	\$	\$	\$	\$	\$	\$	\$	\$
	26. PROPERTY	I. CONSUM-ABLES	J. LIVESTOCK	K. DRUGS	L. MARINE ITEMS	M. CONSTRUCTION ITEMS	N. LAWN AND GARDEN	O. SPORTING GOODS	P. MISC BICYCLE
	STOLEN	\$	\$	\$	\$	\$	\$	\$	\$
	RECOVERED	\$	\$	\$	\$	\$	\$	\$	\$

27. PROPERTY RECOVERED: LOCALLY _____ OTHER JURISDICTION _____ (INSERT O OR L)

PROPERTY ITEMIZATION	PROPERTY STOLEN/RECOVERED ITEMIZATION, USE THE FOLLOWING FORMAT			
	28. QUANTITY	29. ARTICLE NAME	30. BRAND NAME	31. SERIAL NUMBER
				S R <input type="checkbox"/> <input type="checkbox"/>
				S R <input type="checkbox"/> <input type="checkbox"/>
				S R <input type="checkbox"/> <input type="checkbox"/>
				S R <input type="checkbox"/> <input type="checkbox"/>
				S R <input type="checkbox"/> <input type="checkbox"/>
				S R <input type="checkbox"/> <input type="checkbox"/>

33. PROPERTY DAMAGE AMOUNT \$ _____

34. INSURANCE COMPANY _____

35. OFFICER ASSAULTED Y N

36. ARSON Y N

37. STRUCTURE CODE _____ 38. DAMAGE \$ _____

	ENTERED	CANCELLED
47. CIB	<input type="checkbox"/>	<input type="checkbox"/>
NCIC	<input type="checkbox"/>	<input type="checkbox"/>
OTHER BROADCAST	<input type="checkbox"/>	<input type="checkbox"/>

48. TOTAL AMOUNT PROPERTY STOLEN \$ _____

49. TOTAL AMOUNT PROPERTY RECOVERED \$ _____

50. IS REPORT CONTINUED? YES NO

51. CAUTION INDICATORS, ATLS ETC.

52. DATA PROCESS INFORMATION:

COMPUTER ENTERED DATE 16 29 99
 MICROFILM INDEXED INITIAL KS

53. FILE APPROVAL

IS CASE CLASSIFICATION CORRECT? IF N HAS CORRECTION BEEN MADE?
 Y N

BY [Signature] DATE 10/6/99

MANITOWOC COUNTY SHERIFF'S DEPARTMENT
FOLLOW-UP REPORT

Page: 2

CASE NUMBER: 599-02404 CLASSIFICATION: _____

INCIDENT: _____

DATE AND TIME: _____

REPORT CONTINUED:

Just prior to their arrival, I (Deputy Jost) took 5 Polaroid pictures with the one-to-one Polaroid camera. These pictures were taken due to the time of day as it was starting to get dark out. These pictures were later property tagged and placed into locker #29 in the Temporary Evidence Room.

Upon Deputy Colborn's arrival, we pushed the van backward so as to lift the front of the van up so he (Deputy Colborn) could take more photos of the undercarriage of the van. Approximately 16 exposures were taken. This film was later turned in at MTSO.

At this point, we took a new blue tarp which MICHAEL KNORR had just unwrapped from its package. This tarp was used to cradle underneath the transmission and part of the front axle assembly to catch any material that might fall from the undercarriage. We also placed a large sheet of plastic on the bed of the flatbed wrecker and this was also used to gather any evidence that might fall from the van.

The van was then transported via the flatbed to MTSO with Deputy Colborn following the van. Deputy Colborn took the necessary measures to protect the van, wrapping tape around it, indicating it was evidence.

We also gathered the grease and mud which was piled up. [redacted] scraped these items off the a-arm/axle area of the truck. This ground was placed into a larger Ziploc bag and later placed into the Evidence Room at MTSO.

Property tag was attached to the van. The possible hair samples will be sent out, possibly to the State Crime Lab for analyzation.

Further follow-up will be done. JMJost /bjc

When talking to [redacted] I (Deputy Jost) also questioned him about what KENNETH KNAPP told him when he sold him the van and what raised his suspicions. [redacted] told me he was just looking for another vehicle to haul things around in and found the van that KNAPP had for sale for \$300. [redacted] told me, without evening questioning KNAPP, KNAPP began stating the cops were already at his house, looking at the van, and taking pictures of it. He was basically bragging about this. KNAPP also told [redacted] he replaced the grill due to the other one being damaged and he also replaced the transmission recently.

[redacted] told me KNAPP originally had a price of \$300 on the van. Without saying anything, KNAPP dropped the price to \$175. [redacted] stated he was able to purchase the van for \$150, and this also raised his suspicions somewhat that KNAPP would let the van go for that price. [redacted] stated KNAPP told him he was short on money--the reason for selling it so cheap.

[redacted] indicated what raised his suspicions even more was when he began scraping the grease from underneath the van and found the possible hair fibers. He stated, at this point, he collected those items, placed them in a plastic baggy, and then brought them to MTSO.

I do not have any further information reference this report. JMJost /bjc

03/29/99 2130hrs Contact made with Sgt.Lenk, evidence will be sent to Crime Lab in AM.

MANITOWOC COUNTY SHERIFF'S DEPARTMENT
FOLLOW-UP REPORT

Page: 3

CASE NUMBER: 599-02404 CLASSIFICATION: _____

INCIDENT: _____

DATE AND TIME: _____

REPORT CONTINUED:

O TIFFANY JAMIE S [REDACTED] [REDACTED] Adams St, Two Rivers

03/30/99 @ 2000 Hrs.: Contact was made the previous evening with Det. Sgt. Lenk, and a request was made to have the plastic bag containing the suspected hair samples sent to the Crime Lab where the samples could be tested to determine whether or not it was human hair. If the hair is human, they should compare it to the DNA of the victim, RICHARD HOCHSTETLER. A phone call, prior to sending the evidence, was made by Det. Sgt. Lenk to attempt to light a bit of a fire under the Crime Lab as we have this vehicle in our Garage at this time.

Upon arriving to work, I (Lt. M. Bushman) received a note to contact MELISSA PULS reference her boyfriend's, KENNETH KNAPP'S, previously owned vehicle, the Chevrolet van parked in the MTSO Garage. She wished to state the damage on the vehicle--the missing grill and the headlight assembly--was like that when the vehicle was purchased by KNAPP from DALE LANE. Apparently, KNAPP then bought a second van and swapped the parts to complete one front grill. He then sold the van to [REDACTED]. PULS was very suspicious of [REDACTED] from the beginning and wants to file a harassment charge against [REDACTED] as [REDACTED] has now called KNAPP, demanding his \$150 back. Apparently, \$150 was the purchase price of the van. He stated KNAPP sold him the vehicle, and now, the cops took it away; therefore, he wants his money back.

The entire incident was explained to PULS. She stated, while the van was in their possession, hers and KNAPP'S dogs which are a boxer-mix had puppies and the entire group was continuously climbing under the van while it was parked at their residence. She believed the hair would be from the dogs. She was very concerned and upset by the way [REDACTED] had threatened KNAPP. She wished, as soon as we have any information about the type of hair under the van, I give her a call back. I stated, if it was human hair, we would be coming back to do more talking with KNAPP and herself.

Shortly after I hung up the phone, DALE LANE called MTSO and wished to speak with me. He stated he sold the van to KENNETH KNAPP for \$30 and had previously purchased the van from JAMIE TIFFANY for \$30. Apparently, LANE did not do any fixing, and the vehicle was damaged extensively with no front grill or headlamps at the time he purchased it. LANE stated he originally purchased the vehicle from TIFFANY approximately 4 months ago--he stated it was prior to Christmas. LANE does not have a DL and never operated the vehicle. He eventually sold it to KNAPP as-is. It sounded as if LANE had received a call from PULS, prompting him to call MTSO on KNAPP'S behalf.

Attached to this complaint is a Transmittal of Criminal Evidence form photocopy showing Det. Sgt. Lenk mailed the evidence to the Crime Lab on 03/30/99. MJBushman [Signature] /bjc

05/13/99: I, Deputy Colborn, was informed by Sgt. Schetter that this vehicle was no longer considered a suspect vehicle for incident #S99-00242. Sgt. Schetter instructed me to make arrangements with [REDACTED] to have the vehicle removed from the south garage at MTSO.

MANITOWOC COUNTY SHERIFF'S DEPARTMENT
FOLLOW-UP REPORT

Page: 4

CASE NUMBER: 599-02404 CLASSIFICATION: _____

INCIDENT: _____

DATE AND TIME: _____

REPORT CONTINUED:

05/13/99 @ 1400 Hrs.: I, Deputy Colborn, had Hwy 42 Garage respond to MISO where they picked up the vehicle. The vehicle was then transported by Hwy 42 Garage to [REDACTED] Reifs Mills Rd. and turned over to [REDACTED] personally.

[REDACTED] was thanked for his cooperation for this incident. No further action taken at this time. This incident is to be returned to Lt. Bushman for his review upon completion of typing. AColborn /paf

MANITOWOC COUNTY SHERIFF'S DEPARTMENT
FOLLOW-UP REPORT

Page: 86

CASE NUMBER: S99-00242 CLASSIFICATION: _____

INCIDENT: _____

DATE AND TIME: _____

REPORT CONTINUED:

area was the carferry slip and the barge slip immediately west of the carferry. Officers then worked the City river banks on both sides, any place a veh. could have driven in and there was sufficient depth in the river to hide the veh. The banks were worked as far as the bridge west of Burger Boat Co. Nothing unusual was graphed on the bottom that remotely resembled the size of a veh. Numerous passes were made at any site that had potential of the veh. getting a running start and crossing at least 20 ft. of water before falling.
MJBushman/ klf

05-06-99: I, Lt. Bushman, worked on and closed out Crimestopper complaints:

S99-03425,
S99-03182, and
S99-02308.

05-08-99: I, Lt. Bushman, worked on and closed out Crimestopper complaints:

S99-02834, and
S99-03406.

MJBushman/ klf

05-14-99: This entry will be in ref. to Crimestopper # S99-02746. I, Det. Sgt. James Lenk, of MTSO did send the hair samples taken from this veh. to the WI State Crime Lab in Madison on 03-30-99. The reason for the transmittal of evidence was to determine if the hair samples were human or animal and if they could possibly be the hair from RICK HOCHSTETTLER, who is the victim of the hit & run in this case. The State Crime Lab # assigned to this case was M99102. On 04-19-99, I contacted the State Crime Lab and spoke to SHERRY. She stated there were three human hairs and some animal hairs in the samples that were sent. SHERRY also stated that there was not a root structure on the human hair and therefore they were unable to do a DNA test at that State Crime Lab. I asked her to determine the length of the human hair samples as well as a color. She said she would check and get back with me.

I contacted the Milwaukee Office of the FBI in ref. to getting a possible DNA test done on the human hairs. I was advised from the FBI in Milwaukee to contact the FBI in Quantico, VA phone # [REDACTED]. They advised that if we needed a DNA test done of a human hair without the hair follicle, that testing would be called a mitrocondial DNA test or they referred to it as DNA 2. That test is done through the FBI Office Labs in Washington, D.C. The Unit Chief of that lab is JOE DIZINNO, telephone [REDACTED]. I advised the FBI agent that I spoke with that I would probably be getting back in touch with them as soon as we could determine the possibility that these samples could be the victim, RICK HOCHSTETTLER's.

05-04-99: I received a call from the State Crime Lab from SHERRY in ref. to the length and color of the hair samples that were determined to be human samples sent to them. She stated that the hairs were less than 2", somewhere in the area of 1 1/2", closer to 1 3/4",

MANITOWOC COUNTY SHERIFF'S DEPARTMENT
FOLLOW-UP REPORT

Page: 87

CASE NUMBER: S99-00242 CLASSIFICATION: _____

INCIDENT: _____

DATE AND TIME: _____

REPORT CONTINUED:

and the color would be light to medium brown.

05-04-99: I contacted the Manitowoc Coroner, Debra Kakatsch, and asked her to check the hair samples that were taken from the victim to determine the exact length and color of the hairs.

05-05-99: The Coroner, Debra Kakatsch, returned the call stating that the longest hair strand sample that was taken from RICK HOCHSTETTLER is approx. 1" in length which includes the hair follicle and the color is dark brown. At this point it is noted that those lengths and color would not match the samples that were sent to the Crime Lab.

05-04-99: I spoke with Lt. Hermann and advised him that per the Sheriff, they would like the van that was placed into evidence to be transported to the Crime Lab for further testing in a covered veh.

05-11-99: Lt. Hermann contacted myself and stated the van will not be sent to the State Crime Lab as he had conferred with Insp. Petersen, as well as the Sheriff, and determined that the veh. would not be the veh. in question in this hit & run. The veh. was determined at that point that it could be released back to the owner. Det. Sgt. James Lenk/ klf

PROPERTY/EVIDENCE CONTROL

INVENTORY LOCATION SOUTH GARAGE

1. INCIDENT <u>599-00242</u>	2. ITEM <u>VAN</u>	3. DATE <u>032099</u>	4. <input checked="" type="checkbox"/> FELONY Release Date: _____	<input type="checkbox"/> MIS.	<input type="checkbox"/> PROPERTY
---------------------------------	-----------------------	--------------------------	--	-------------------------------	-----------------------------------

5. ITEM NAME <u>CHEV</u>	6. BRAND NAME	7. MODEL <u>VAN</u>	8. SERIAL NO. <u>VIEW #</u>
-----------------------------	---------------	------------------------	-----------------------------

9. OTHER DESCRIPTION OR IDENTIFYING MARKS: (ONE ITEM ONLY) <u>TAN COLORED CHEV VAN, DAMAGE TO GRILL AND DRIVER + PASSENGER SIDE</u>	10. CITATION NOS.
--	-------------------

11. TOWED VEHICLES	Wrecker	Amount	12. EMPLOYEE NO: <u>449/432</u>
Abandoned <input type="checkbox"/> Impounded <input type="checkbox"/>	Rel. Date _____	Auth. By _____	DATE REC: <u>03-26-99</u>

13. CHAIN OF POSSESSION:		14. DATE	15. TIME	16. REASON FOR TRANSFER:
FROM	<u>REIF'S MILLS RD.</u>	<u>03-26-99</u>	<u>1815HRS</u>	<u>TAKEN INTO OFFICER'S POSSESSION</u>
TO	<u>JOST 449</u>	<u>"</u>	<u>"</u>	
FROM	<u>JOST 449</u>	<u>03-26-99</u>	<u>1945HRS</u>	<u>CUSTODY TRANSFER - EVIDENCE PURPOSES</u>
TO	<u>COLBORN 432</u>	<u>"</u>	<u>"</u>	
FROM	<u>COLBORN 432</u>	<u>03-26-99</u>	<u>2100HRS</u>	<u>PLACED INTO GARAGE - EVIDENCE</u>
TO	<u>SOUTH GARAGE</u>	<u>"</u>	<u>"</u>	
FROM	<u>SOUTH GARAGE</u>	<u>05/11/99</u>	<u>111</u>	<u>RELEASED FOR TOW BACK TO OWNER (LIC #432)</u>
TO	<u>HWY 42 GARAGE</u>	<u>1/3/99</u>	<u>100</u>	
FROM				
TO				
FROM				
TO				
FROM				
TO				

PLACE YELLOW COPY WITH INCIDENT UPON PLACING IN EVIDENCE LOCKER

1. CASE # **S99 No 01202** 2. CLASSIFICATION **6,3|0,1** 3. CENSUS **5 2|0,0,0**

INCIDENT **637899-00242**

5. INCIDENT LOCATION

6. NAME - LAST - FIRST - MI **Anonymous** 7. D.O.B.

8. ADDRESS 9. TX-HOME

11. CITY STATE ZIP 10. TX-BUSINESS

12. DETAILS **See Attached.**

02/10/99 1630

MANITOWOC COUNTY SHERIFF INCIDENT CARD

18. ASSIGNED
MTSO CS 9/12/99
M.J. Bushman 4/1/99

19. REC. BY **935** 20. DIS. BY
 22. TYPE OF REPORT
 1. INCIDENT
 2. ACCIDENT
 3. CITATION
 4. NONE

21. HOW REC'D.
 1. 911
 2. POLICE RADIO
 3. PHONE
 4. TTY
 5. IN PERSON
 6. ON VIEW
 7. OFF. OFF DUTY
 8. C.B. RADIO
 9. OTHER

23. STATUS
 1. UNFOUNDED
 2. PNL
 3. OTHER
 4. CLEARED
 5. EXCEPT CLEARED

24. DATE CLEARED **03 08 1999**

25. OFFENSE TYPE
 1. ADULT
 2. JUVENILE
 3. UNKNOWN

14. REC'D	15. DISP	16. 10-23	17. 10-24
13. DAY			
SUN 1	THU 5		
MON 2	FRI 6		
TUE 3	SAT 7		
WED 4			

39. (CODE S-SUSPECT W-WITNESS V-VICTIM O-OTHER)				42. ADDRESS		43. TELEPHONE
CODE	40. NAME-LAST	FIRST	MI	41. D.O.B.		
0	Knapp, Kenneth D.	418			N. Packer Dr., Whitelaw	

02/17/99 Attempted contact at [redacted] Packer Dr. however Kenneth was at work in Manitowoc at PDQ. Noting it was after 1600hrs Off. inquired as to where Knapp could be found now. IT was learned he was at his girlfriend's house [redacted] E. River Two Rivers, Missy Pautz. Contact made by phone and arrangements made with T.R.P.D. Off. Keery to swing by the residence and check the vehicle. Suspect vehicle is an 80 Chev van with a large blk grill the design not consistant with the photo's passed on to T.R.P.D. There is not other sheet metal damage. This is not the suspect vehicle, close out. M.J. Bushman

REC'D

1. CASE # **S99 No 01959** 2. CLASSIFICATION **6,30,11** 3. CENSUS **7,0000**

4. INCIDENT **CS/S99-00242**

5. INCIDENT LOCATION **CTH CR**

6. NAME- LAST-FIRST-MI **ANONYMOUS** 7. D.O.B.

8. ADDRESS 9. TX-HOME

11. CITY STATE ZIP 10. TX-BUSINESS

12. DETAILS
**CALLER'S FRIEND RECENTLY PURCHASED
 A GREEN/WHITE GMC VAN (POSS 1979)
 FOR "JUNK PRICE" WHICH HAS DAMAGE
 TO GRILL & BUMPER ON PASS. SIDE.**

2038
3-9-99

**MANITOWOC COUNTY SHERIFF
INCIDENT CARD**

18. ASSIGNED **MTSO** **9/29**
4/4/1

19. REC. BY **932** 20. DIS. BY
 22. TYPE OF REPORT
 1. INCIDENT
 2. ACCIDENT
 3. CITATION
 4. NONE

21. HOW REC'D.
 1. 911
 2. POLICE RADIO
 3. PHONE
 4. TTY
 5. IN PERSON
 6. ON VIEW
 7. OFF. OFF DUTY
 8. C.B. RADIO
 9. OTHER
 21A. M.O.
 23. STATUS
 1. UNFOUNDED
 2. PNL
 3. OTHER
 4. CLEARED
 5. EXCEPT CLEARED
 24. DATE CLEARED **03/16/99**
 25. OFFENSE TYPE
 1. ADULT NA
 2. JUVENILE
 3. UNKNOWN

14. REC'D 15. DISP 16. 10-23 17. 10-24
 13. DAY
 SUN 1 THU 5
 MON 2 FRI 6
 TUE 3 SAT 7
 WED 4

39. (CODE S-SUSPECT W-WITNESS V-VICTIM O-OTHER)				41. D.O.B.		42. ADDRESS		43. TELEPHONE	
CODE	40. NAME-LAST	FIRST	MI						
0	[REDACTED]	[REDACTED]	[REDACTED]	[REDACTED]	[REDACTED]	[REDACTED]	[REDACTED]	[REDACTED]	[REDACTED]
0	Knapp, Kenneth D.	418		[REDACTED]	[REDACTED]	19th St, Two Rivers	[REDACTED]	[REDACTED]	[REDACTED]

03/11/99 1432hrs Contact made by phone with Kewaunee Co. SO and request made to assist by making contact. Crime Stoppers work sheet faxed after name of complainant was blacked out as he wished to remain anonymous. M.J. Bushman

03/13/99 Off. Kuehl Kewaunee Co. SO located the vehicle in question at [REDACTED] now owned by [REDACTED] who purchased it from Kenneth D. Knapp Two Rivers, in late February early March, just to be used for parts. At the time the Crime Stoppers complaint came in it was not known the seller was Kenneth Knapp. That van was checked by joint effort with myself and Two Rivers PD in Crimestoppers complaint # S99-01202. Close out. M.J. Bushman

1. CASE # S99 No 02445	2. CLASSIFICATION 0,310,11	3. CENSUS 5,210,00
4. INCIDENT OS / S99-00242		
5. INCIDENT LOCATION Cornet Ave - 3500 blk.		
6. NAME - FIRST - MI ANONY (2)	7. D.O.B.	
8. ADDRESS	9. TX-HOME	
11. CITY STATE ZIP	10. TX-BUSINESS	
12. DETAILS SEE ATTACHED.		

03-27-99 1543

14. REC'D	15. DISP	16. 10-23	17. 10-24
13. DAY			
SUN 1	THU 5		
MON 2	FRI 6		
TUE 3	SAT 7		
WED 4			

MANITOWOC COUNTY SHERIFF INCIDENT CARD		
18. ASSIGNED MTSO 9129		
19. REC. BY 930	20. DIS. BY	22. TYPE OF REPORT
21. HOW REC'D.		<input checked="" type="radio"/> 1. INCIDENT <input type="radio"/> 2. ACCIDENT <input type="radio"/> 3. CITATION <input type="radio"/> 4. NONE
<input checked="" type="radio"/> 1. 911 <input checked="" type="radio"/> 2. POLICE RADIO <input type="radio"/> 3. PHONE <input type="radio"/> 4. TTY <input type="radio"/> 5. IN PERSON <input type="radio"/> 6. ON VIEW <input type="radio"/> 7. OFF. OFF DUTY <input type="radio"/> 8. C.B. RADIO <input type="radio"/> 9. OTHER		<input checked="" type="radio"/> 1. UNFOUNDED <input type="radio"/> 2. PNL <input checked="" type="radio"/> 3. OTHER <input type="radio"/> 4. CLEARED <input type="radio"/> 5. EXCEPT CLEARED
21A.M.O.		24. DATE CLEARED 04/299
		25. OFFENSE TYPE
		<input type="checkbox"/> 1. ADULT <input type="checkbox"/> NA <input type="checkbox"/> <input type="checkbox"/> 2. JUVENILE <input type="checkbox"/> <input type="checkbox"/> 3. UNKNOWN <input type="checkbox"/>

39. (CODE S-SUSPECT W-WITNESS V-VICTIM O-OTHER)	40. NAME-LAST	FIRST	MI	41. D.O.B.	42. ADDRESS	43. TELEPHONE
0	Kaufmann, Paul M.	Paul		[REDACTED]	CTH JJ, Mtwc	

03/29/99 This vehicle had been checked and entered into the FBI file system, Comp. #S99-00689. M.J. Bushman **ENTERED 676**

CASE # S99 No 02445

45/ IF COMPLAINANT DIFFERENT THEN CALLER, ENTER NAME, ADDRESS, D.O.B., TELEPHONE.

4.6. IF CODE O (OTHER) IS USED IN FIELD #39, EXPLAIN.

INCIDENT REPORT: NOTE: IF SECTION 22 ABOVE HAS NUMBER 4 CHECKED, DO NOT GO BEYOND THIS LINE WITHOUT RECORDS SECTION BEING ADVISED, OR NO RECORD ENTRIES WILL BE MADE BELOW THIS LINE.

PROPERTY VALUE	26. PROPERTY	A. CURRENCY	B. JEWELRY	C. FURS CLOTHING	D. VEHICLE (LOCAL)	E. OFFICE EQUIPMENT	F. RADIO, TV CAMERAS	G. FIREARMS	H. HOUSE-HOLD GOODS
	STOLEN	\$	\$	\$	\$	\$	\$	\$	\$
	RECOVERED	\$	\$	\$	\$	\$	\$	\$	\$
	26. PROPERTY	I. CONSUM-ABLES	J. LIVESTOCK	K. DRUGS	L. MARINE ITEMS	M. CONSTRUCTION ITEMS	N. LAWN AND GARDEN	O. SPORTING GOODS	P. MISC BICYCLE
	STOLEN	\$	\$	\$	\$	\$	\$	\$	\$
	RECOVERED	\$	\$	\$	\$	\$	\$	\$	\$

27. PROPERTY RECOVERED: LOCALLY _____ OTHER JURISDICTION _____ (INSERT O OR L)

PROPERTY ITEMIZATION	PROPERTY STOLEN/RECOVERED ITEMIZATION, USE THE FOLLOWING FORMAT				
	28. QUANTITY	29. ARTICLE NAME	30. BRAND NAME	31. SERIAL NUMBER	32. CODE
					S R <input type="checkbox"/> <input type="checkbox"/>
					S R <input type="checkbox"/> <input type="checkbox"/>
					S R <input type="checkbox"/> <input type="checkbox"/>
					S R <input type="checkbox"/> <input type="checkbox"/>
					S R <input type="checkbox"/> <input type="checkbox"/>

33. PROPERTY DAMAGE AMOUNT \$ _____

34. INSURANCE COMPANY _____

35. OFFICER ASSAULTED Y N

36. ARSON Y N

37. STRUCTURE CODE _____

38. DAMAGE \$ _____

47. CIB ENTERED CANCELLED
 NCIC
 OTHER BROADCAST

48. TOTAL AMOUNT PROPERTY STOLEN \$ _____

49. TOTAL AMOUNT PROPERTY RECOVERED \$ _____

50. IS REPORT CONTINUED? YES NO

51. CAUTION INDICATORS, ATLS ETC.

52. DATA PROCESS INFORMATION:

COMPUTER ENTERED DATE 10/29/99
 MICROFILM INDEXED INITIAL JS

53. FILE APPROVAL

IS CASE CLASSIFICATION CORRECT?
 IF N HAS CORRECTION BEEN MADE?

BY QR

DATE 04/12/99

1. CASE # No 02492 2. CLASSIFICATION 6,310,11 3. LENSUS 7,010,00

4. INCIDENT US/S99-00242

5. INCIDENT LOCATION CITY OF GREEN BAY.

6. NAME- LAST-FIRST-MI 7. D.O.B.

8. AD 9. TX-HOME

11. CITY STATE ZIP 10. TX-BUSINESS

12. DETAILS GBPD REC'D CRIMESTOPPER REPORT

OF CITY SUBURBAN, WI RP MND-654

PARLED IN THEIR CITY ON 3-29-99

THAT MATCHES SUSPECT VEH FROM H&R.

1354
3-29-99
14. REC'D 15. DISP 16. 10-23 17. 10-24
13. DAY
SUN 1 THU 5
MON 2 FRI 6
TUE 3 SAT 7
WED 4

MANITOWOC COUNTY SHERIFF
INCIDENT CARD

18. ASSIGNED MTSO 91219

19. REC. BY 932 20. DIS. BY

21. HOW REC'D.
1. 911
2. POLICE RADIO
3. PHONE
4. TTY
5. IN PERSON
6. ON VIEW
7. OFF. OFF DUTY
8. C.B. RADIO
9. OTHER FAX

22. TYPE OF REPORT
1. INCIDENT
2. ACCIDENT
3. CITATION
4. NONE

23. STATUS
1. UNFOUNDED
2. PNL
3. OTHER
4. CLEARED
5. EXCEPT CLEARED

24. DATE CLEARED 10/11/99

25. OFFENSE TYPE
1. ADULT NA
2. JUVENILE
3. UNKNOWN

39. (CODE S-SUSPECT W-WITNESS V-VICTIM O-OTHER)	40. NAME-LAST	FIRST	MI	41. D.O.B.	42. ADDRESS	43. TELEPHONE
0	Xiong, Kao				11th Ave. Green Bay	
	Green Bay Police				Com.Center Fax	

03/30/99 0006hrs Contact made with Lt. Hemes Green Bay Police Shift Commander and a request for assistance made by phone. He requested a fax of the report which was completed immediately with photo copy of full description of suspect vehicle damage. M.J.Bushman 0020hrs GBPD called back vehicle not there, they will have a day shift check. Called again as Officer was pulling away vehicle drove in.

0100hrs Off. Todd Lepine works that section of town and was familiar with the vehicle in question. He spoke with the owner who drove in while the Officer was out checking. He advised Kao Xiong he was out checking for some kids running through the back yards. Eventually he looked over the Suburban as he stood and talked with the owner. The vehicle is higher than normal because of large oversize tires. There is very little damage with two small plastic parts broke from the grill and a small chip from a bug shield. Nothing damaged on the hood, bumper, or windshield. He stated he did not have the fax with him on the street and will go back a second time later in the night. This does not fit the description of the Hit&Run vehicle. Close Out. M.J.Bushman

03/30/99 2000hrs Photo copy of Officers remarks were faxed to MTSO and are attached. M.J.Bushman
ENTERED ETC

S99
No 02492

45. IF COMPLAINANT DIFFERENT THEN CALLER, ENTER NAME, ADDRESS, D.O.B., TELEPHONE.

46. IF CODE O (OTHER) IS USED IN FIELD #39, EXPLAIN.

INCIDENT REPORT: NOTE: IF SECTION 22 ABOVE HAS NUMBER 4 CHECKED, DO NOT GO BEYOND THIS LINE WITHOUT RECORDS SECTION BEING ADVISED, OR NO RECORD ENTRIES WILL BE MADE BELOW THIS LINE.

PROPERTY VALUE	26. PROPERTY	A. CURRENCY	B. JEWELRY	C. FURS CLOTHING	D. VEHICLE (LOCAL)	E. OFFICE EQUIPMENT	F. RADIO, TV CAMERAS	G. FIREARMS	H. HOUSE-HOLD GOODS
	STOLEN	\$	\$	\$	\$	\$	\$	\$	\$
	RECOVERED	\$	\$	\$	\$	\$	\$	\$	\$
	26. PROPERTY	I. CONSUM-ABLES	J. LIVESTOCK	K. DRUGS	L. MARINE ITEMS	M. CONSTRUCTION ITEMS	N. LAWN AND GARDEN	O. SPORTING GOODS	P. MISC BICYCLE
	STOLEN	\$	\$	\$	\$	\$	\$	\$	\$
	RECOVERED	\$	\$	\$	\$	\$	\$	\$	\$

27. PROPERTY RECOVERED: LOCALLY _____ OTHER JURISDICTION _____ (INSERT O OR L)

PROPERTY ITEMIZATION	PROPERTY STOLEN/RECOVERED ITEMIZATION, USE THE FOLLOWING FORMAT				
	28. QUANTITY	29. ARTICLE NAME	30. BRAND NAME	31. SERIAL NUMBER	32. CODE
					S <input type="checkbox"/> R <input type="checkbox"/>
					S <input type="checkbox"/> R <input type="checkbox"/>
					S <input type="checkbox"/> R <input type="checkbox"/>
					S <input type="checkbox"/> R <input type="checkbox"/>
					S <input type="checkbox"/> R <input type="checkbox"/>

33. PROPERTY DAMAGE AMOUNT \$ _____

34. INSURANCE COMPANY _____

35. OFFICER ASSAULTED Y N 36. ARSON Y N 37. STRUCTURE CODE _____ 38. DAMAGE \$ _____

47. CIB ENTERED CANCELLED
 NCIC
 OTHER BROADCAST

48. TOTAL AMOUNT PROPERTY STOLEN \$ _____

49. TOTAL AMOUNT PROPERTY RECOVERED \$ _____

50. IS REPORT CONTINUED? YES NO

51. CAUTION INDICATORS, ATLS ETC.

52. DATA PROCESS INFORMATION:

COMPUTER ENTERED DATE 16 09 99
 MICROFILM INDEXED INITIAL RS

IS CASE CLASSIFICATION CORRECT? N
 IF N HAS CORRECTION BEEN MADE? N

53. FILE APPROVAL

BY JK DATE 04 12 99

1. CASE # **S99 No 02497** | 2. CLASSIFICATION **63011** | 3. CENSUS **701000**

4. INCIDENT **CS/599-00242**

5. INCIDENT LOCATION **W. JOHNSON, FOND DU LAC**

6. LAST-FIRST-MI [REDACTED] | 7. D.O.B. [REDACTED] **JUVENILE INFO REDACTED**

8. ADDRESS [REDACTED] | 9. TX-HOME [REDACTED]

11. CITY [REDACTED] | 10. TX-BUSINESS [REDACTED]

12. DETAILS **SAW TRUCK COVERED BY TARP 3/27/99**

AT MIKE'S FRAME & AUTO IN

FOND DU LAC. TARP COVERED AREA

WHERE HE R DAMAGE WOULD BE -
WAS TOO DARK TO OBTAIN RP.

1700
3-29-99

**MANITOWOC COUNTY SHERIFF
INCIDENT CARD**

18. ASSIGNED **MTSO** | **91219**

19. REC BY **932** | 20. DIS. BY [REDACTED]

22. TYPE OF REPORT:
 1. INCIDENT
 2. ACCIDENT
 3. CITATION
 4. NONE

21. HOW REC'D.
 1. 911
 2. POLICE RADIO
 3. PHONE
 4. TTY
 5. IN PERSON
 6. ON VIEW
 7. OFF. OFF DUTY
 8. C.B. RADIO
 9. OTHER

23. STATUS
 1. UNFOUNDED
 2. PNL
 3. OTHER
 4. CLEARED
 5. EXCEPT CLEARED

24. DATE CLEARED **10/12/99**
 25. OFFENSE TYPE
 1. ADULT NA
 2. JUVENILE
 3. UNKNOWN

14. REC'D | 15. DISP | 16. 10-23 | 17. 10-24
 13. DAY
 SUN 1 | THU 5
 MON 2 | FRI 6
 TUE 3 | SAT 7
 WED 4

39. (CODE S-SUSPECT W-WITNESS V-VICTIM O-OTHER)				42. ADDRESS		43. TELEPHONE
CODE	40. NAME-LAST	FIRST	MI	41. D.O.B.		
O	Mike's Frame and Auto				Fond Du Lac	[REDACTED]
O	Moon, Michael A.				Chelen Ridge, Van Dyke	[REDACTED]

03/30/99 1512hrs Contact by phone made with Mike Moon in Fond Du Lac owner of Mike's Frame & Auto. He was informed of the Crimes Stopper information received and questioned whether he had a truck covered on his property. He stated: "The only vehicle I currently have covered on my property and the last one within a month is a white 1997 GMC P/U with 10,000 miles. It has black replacement fenders and no registration because it's a rebuild. It was damaged around November 98 and I told the guy who owns it that I'd rebuild it for him when I looked at it. I know for a fact it has not been on the road since at least November. Its under a blue tarp.

Close Out. M.J. Bushman
MJB

ENTERED ETC

45. IF COMPLAINANT DIFFERENT THEN CALLER, ENTER NAME, ADDRESS, D.O.B., TELEPHONE.

46. IF CODE O (OTHER) IS USED IN FIELD #39, EXPLAIN.

INCIDENT REPORT: NOTE: IF SECTION 22 ABOVE HAS NUMBER 4 CHECKED, DO NOT GO BEYOND THIS LINE WITHOUT RECORDS SECTION BEING ADVISED, OR NO RECORD ENTRIES WILL BE MADE BELOW THIS LINE.

PROPERTY VALUE	26. PROPERTY	A. CURRENCY	B. JEWELRY	C. FURS CLOTHING	D. VEHICLE (LOCAL)	E. OFFICE EQUIPMENT	F. RADIO, TV CAMERAS	G. FIREARMS	H. HOUSE-HOLD GOODS
	STOLEN	\$	\$	\$	\$	\$	\$	\$	\$
	RECOVERED	\$	\$	\$	\$	\$	\$	\$	\$
	26. PROPERTY	I. CONSUMABLES	J. LIVESTOCK	K. DRUGS	L. MARINE ITEMS	M. CONSTRUCTION ITEMS	N. LAWN AND GARDEN	O. SPORTING GOODS	P. MISC BICYCLE
STOLEN	\$	\$	\$	\$	\$	\$	\$	\$	
RECOVERED	\$	\$	\$	\$	\$	\$	\$	\$	

27. PROPERTY RECOVERED: LOCALLY _____ OTHER JURISDICTION _____ (INSERT O OR L)

PROPERTY ITEMIZATION	PROPERTY STOLEN/RECOVERED ITEMIZATION, USE THE FOLLOWING FORMAT				
	28. QUANTITY	29. ARTICLE NAME	30. BRAND NAME	31. SERIAL NUMBER	
					S <input type="checkbox"/> R <input type="checkbox"/>
					S <input type="checkbox"/> R <input type="checkbox"/>
					S <input type="checkbox"/> R <input type="checkbox"/>
					S <input type="checkbox"/> R <input type="checkbox"/>
					S <input type="checkbox"/> R <input type="checkbox"/>

33. PROPERTY DAMAGE AMOUNT \$ _____ 34. INSURANCE COMPANY _____

35. OFFICER ASSAULTED Y N 36. ARSON Y N 37. STRUCTURE CODE _____ 38. DAMAGE \$ _____

47. CIB ENTERED CANCELLED
 NCIC
 OTHER BROADCAST

48. TOTAL AMOUNT PROPERTY STOLEN \$ _____
 49. TOTAL AMOUNT PROPERTY RECOVERED \$ _____

50. IS REPORT CONTINUED? YES NO
 51. CAUTION INDICATORS, ATLS ETC.

52. DATA PROCESS INFORMATION:
 COMPUTER ENTERED DATE 16/09/99
 MICROFILM INDEXED INITIAL RS
 IS CASE CLASSIFICATION CORRECT? Y N
 IF N HAS CORRECTION BEEN MADE? Y N

53. FILE APPROVAL
 BY [Signature] DATE 10/12/99

Tx for
Mike's Frame
& Auto - [REDACTED]

IMPORTANT MESSAGE

FOR Lt. Sushman
DATE 3/29/99 TIME 1416 (P.M.)

M Andy Trullinger
OF Lincoln High School Liaison

PHONE AREA CODE [REDACTED] NUMBER [REDACTED] EXTENSION [REDACTED]

FAX

MOBILE AREA CODE _____ NUMBER _____ TIME TO CALL _____

TELEPHONED	<input checked="" type="checkbox"/>	PLEASE CALL	
CAME TO SEE YOU		WILL CALL AGAIN	
WANTS TO SEE YOU		RUSH	
RETURNED YOUR CALL		SPECIAL ATTENTION	

MESSAGE Spoke with student today
about H&R - veh in Fond du Lac.
He advised her to call Cimestoppus
she will call later. If you have
further questions, call Andy btw
7:30 a - 3:30 p

SIGNED _____

1. CASE # S99 No 02520 | 2. CLASSIFICATION 631011 | 3. CENSUS 521000

MANITOWOC COUNTY SHERIFF
INCIDENT CARD

4. INCIDENT # CS/ See S99-00242

INCIDENT LOCATION 800 block QUAY STR. / MTWC

6. NAME - LAST - FIRST - MI MTPD (3) | 7. D.O.B.

8. ADDRESS | 9. TX-HOME

11. CITY STATE ZIP | 10. TX-BUSINESS

12. DETAILS OFFICER 523 REPORTS BK 17438

180 HEV HAS A FRESH

RE-PAINT JOB. MTSO 432 STATES

THIS TRK WAS NOT CHECKED PRIOR
see below

1037 03-30-99
1100 03-30-99
1114
1120
14. REC'D: 15. DISP: 16. 10-23: 17. 10-24:
13. DAY
SUN 1 THU 5
MON 2 FRI 6
TUE 3 SAT 7
WED 4

18. ASSIGNED
MTSO 929
MTPD 935

19. REC. BY 930 | 20. DIS. BY 930

21. HOW REC'D.
1. 911
2. POLICE RADIO
3. PHONE
4. TTY
5. IN PERSON
6. ON VIEW
7. OFF. OFF DUTY
8. C.B. RADIO
9. OTHER

21A. M.O.

22. TYPE OF REPORT
1. INCIDENT
2. ACCIDENT
3. CITATION
4. NONE

23. STATUS
1. UNFOUNDED
2. PNL
3. OTHER
4. CLEARED
5. EXCEPT CLEARED

24. DATE CLEARED 10/12/99

25. OFFENSE TYPE
1. ADULT NA
2. JUVENILE
3. UNKNOWN

39. (CODE S-SUSPECT W-WITNESS V-VICTIM O-OTHER)				41. D.O.B.		42. ADDRESS		43. TELEPHONE	
CODE	40. NAME-LAST	FIRST	MI						

03/30/99 (cont) MTPD 523 states this vehicle is currently in the 800 block of Quay Str. DB/930

03/30/99 MTPD Officer Kabelowsky did check above vehicle at Quay Str.; reports this is not the suspect vehicle in S99-00242. DB

03/30/99 Vehicle was not entered in FBI program, enter and close out. M.J. Bushnell
ENTERED ETC

45. IF COMPLAINANT DIFFERENT THEN CALLER, ENTER NAME, ADDRESS, D.O.B., TELEPHONE.

46. IF CODE O (OTHER) IS USED IN FIELD #39, EXPLAIN.

INCIDENT REPORT: NOTE: IF SECTION 22 ABOVE HAS NUMBER 4 CHECKED, DO NOT GO BEYOND THIS LINE WITHOUT RECORDS SECTION BEING ADVISED, OR NO RECORD ENTRIES WILL BE MADE BELOW THIS LINE.

PROPERTY VALUE	26. PROPERTY	A. CURRENCY	B. JEWELRY	C. FURS CLOTHING	D. VEHICLE (LOCAL)	E. OFFICE EQUIPMENT	F. RADIO, TV CAMERAS	G. FIREARMS	H. HOUSEHOLD GOODS
	STOLEN	\$	\$	\$	\$	\$	\$	\$	\$
	RECOVERED	\$	\$	\$	\$	\$	\$	\$	\$
	26. PROPERTY	I. CONSUMABLES	J. LIVESTOCK	K. DRUGS	L. MARINE ITEMS	M. CONSTRUCTION ITEMS	N. LAWN AND GARDEN	O. SPORTING GOODS	P. MISC BICYCLE
STOLEN	\$	\$	\$	\$	\$	\$	\$	\$	
RECOVERED	\$	\$	\$	\$	\$	\$	\$	\$	

27. PROPERTY RECOVERED: LOCALLY _____ OTHER JURISDICTION _____ (INSERT O OR L)

PROPERTY ITEMIZATION	PROPERTY STOLEN/RECOVERED ITEMIZATION, USE THE FOLLOWING FORMAT				
	28. QUANTITY	29. ARTICLE NAME	30. BRAND NAME	31. SERIAL NUMBER	32. CODE
					S <input type="checkbox"/> R <input type="checkbox"/>
					S <input type="checkbox"/> R <input type="checkbox"/>
					S <input type="checkbox"/> R <input type="checkbox"/>
					S <input type="checkbox"/> R <input type="checkbox"/>

33. PROPERTY DAMAGE AMOUNT \$ _____

34. INSURANCE COMPANY _____

35. OFFICER ASSAULTED Y N 36. ARSON Y N 37. STRUCTURE CODE _____ 38. DAMAGE \$ _____

47. CIB ENTERED CANCELLED
 NCIC
 OTHER BROADCAST

48. TOTAL AMOUNT PROPERTY STOLEN \$ _____

49. TOTAL AMOUNT PROPERTY RECOVERED \$ _____

50. IS REPORT CONTINUED? YES NO

51. CAUTION INDICATORS, ATLS ETC.

52. DATA PROCESS INFORMATION:

COMPUTER ENTERED DATE 16/29/99
 MICROFILM INDEXED INITIAL AS

53. FILE APPROVAL

IS CASE CLASSIFICATION CORRECT? N
 IF N HAS CORRECTION BEEN MADE? N

BY [Signature] DATE 10/1/299

**MANITOWOC COUNTY SHERIFF
INCIDENT CARD**

18. ASSIGNED *Kusch*

19. REC. BY *921* 20. DIS. BY

21. HOW REC'D.
 1. 911
 2. POLICE RADIO
 3. PHONE
 4. TTY
 5. IN PERSON
 6. ON VIEW
 7. OFF. OFF DUTY
 8. C.B. RADIO
 9. OTHER

22. TYPE OF REPORT
 1. INCIDENT
 2. ACCIDENT
 3. CITATION
 4. NONE

23. STATUS
 1. UNFOUNDED
 2. PNL
 3. OTHER
 4. CLEARED
 5. EXCEPT CLEARED

24. DATE CLEARED *10/4/2/99*

25. OFFENSE TYPE
 1. ADULT NA
 2. JUVENILE
 3. UNKNOWN

1. CASE # **S99 No 02369** 2. CLASSIFICATION **630.11** 3. CENSUS **5,200.0**

4. INCIDENT **CS** **S99-00242**

5. INCIDENT LOCATION

6. NAME LAST-FIRST-MI **Anonymous** 7. D.O.B.

8. ADDRESS 9. TX-HOME

11. CITY STATE ZIP 10. TX-BUSINESS

12. DETAILS
**RON KAMINSKI STATES THAT
 A CLIENT HAS INFORMATION
 CONCERNING THE FATAL H&R**

03/25/99 1346

14. REC'D
 15. DISP
 16. 10-23
 17. 10-24

13. DAY
 SUN 1 THU 5
 MON 2 FRI 6
 TUE 3 SAT 7
 WED 4

39. (CODE S-SUSPECT W-WITNESS V-VICTIM O-OTHER)						
CODE	40. NAME-LAST	FIRST	MI	41. D.O.B.	42. ADDRESS	43. TELEPHONE
0	KAMINSKI <i>25498</i>	RONALD	A		N 8th St, Manitowoc	
0	PIETROSKE INC <i>9231</i>				Grand Ave, Manitowoc	
0	TERRY ERNST CAR CO <i>50472</i>				Lincoln Ave, Two Rivers	
0	Kakatsch, Debra J. <i>59227</i>				Viebahn St. Mtwc	

03/25/99 @ 1030 Hrs.: I, [REDACTED], met with ATTY. RON KAMINSKI at his office. ATTY. KAMINSKI stated he represented an individual who wished to remain anonymous and would be referred to only by the term "RESIPSA." ATTY. KAMINSKI stated this individual attempted to contact him approximately 10 days ago, stating he had information which may involve the vehicle in the fatal hit and run being investigated by MTSO. ATTY. KAMINSKI stated this vehicle was traded in to the auto dealership owned by BOB PIETROSKE. The vehicle was subsequently transferred to the TERRY ERNST dealership in Two Rivers.

ATTY. KAMINSKI stated his client advised he observed the vehicle and that it had its grill replaced and repairs were made to the right front fender. The front headlights were also replaced.

Further information will be given to the investigating officer. [REDACTED] /bjc

03/30/99 1505hrs Contact made with Kaminski's office by phone, he was out message left. 0332hrs Atty. Kaminski called back and provided the following information. He stated the individual providing the information wished to remain anonymous and go through him to insure his identification is kept secretive. The informant had checked the 1989 Chev Suburban two tone gray in color for repaired damage as it came through the Pietroske business as he had been instructed previously to do with regards to MTSO's unsolved Hit&Run accident. He found that the suburban which was traded in by Mtwc Co. Coroner's office appeared to have been previously damaged and now repaired. The Rt. front headlamp and grill was thought to have been fixed. Vehicle has since gone to the auto auction.

Atty. Kaminski was informed that I was the first officer on scene and the Coroner's pager was called within minutes after my arrival. Coroner Debra Kakatsch arrived on scene with the vehicle in question within one hour, there was no damage on it at that time.

1548hrs Contact made by phone with Debra Kakatsch. She stated the old Coroner's suburban had been budgeted for replacement and was traded off on a newer model the first week in March. There was no damage nor was there previous damage Coroner Kakatsch was aware of during the period of time she drove the vehicle or prior to purchase. Close out. M.J. Bushman

ENTERED ETR

S99 No 02369

223

45. IF COMPLAINANT DIFFERENT THEN CALLER, ENTER NAME, ADDRESS, D.O.B., TELEPHONE.

46. IF CODE O (OTHER) IS USED IN FIELD #39, EXPLAIN.

INCIDENT REPORT: NOTE: IF SECTION 22 ABOVE HAS NUMBER 4 CHECKED, DO NOT GO BEYOND THIS LINE WITHOUT RECORDS SECTION BEING ADVISED, OR NO RECORD ENTRIES WILL BE MADE BELOW THIS LINE.

PROPERTY VALUE	26. PROPERTY	A. CURRENCY	B. JEWELRY	C. FURS CLOTHING	D. VEHICLE (LOCAL)	E. OFFICE EQUIPMENT	F. RADIO, TV CAMERAS	G. FIREARMS	H. HOUSE-HOLD GOODS
	STOLEN	\$	\$	\$	\$	\$	\$	\$	\$
	RECOVERED	\$	\$	\$	\$	\$	\$	\$	\$
	26. PROPERTY	I. CONSUM-ABLES	J. LIVESTOCK	K. DRUGS	L. MARINE ITEMS	M. CONSTRUCTION ITEMS	N. LAWN AND GARDEN	O. SPORTING GOODS	P. MISC BICYCLE
	STOLEN	\$	\$	\$	\$	\$	\$	\$	\$
	RECOVERED	\$	\$	\$	\$	\$	\$	\$	\$

27. PROPERTY RECOVERED: LOCALLY ____ OTHER JURISDICTION ____ (INSERT O OR L)

PROPERTY ITEMIZATION	PROPERTY STOLEN/RECOVERED ITEMIZATION, USE THE FOLLOWING FORMAT			
	28. QUANTITY	29. ARTICLE NAME	30. BRAND NAME	31. SERIAL NUMBER
				S R <input type="checkbox"/> <input type="checkbox"/>
				S R <input type="checkbox"/> <input type="checkbox"/>
				S R <input type="checkbox"/> <input type="checkbox"/>
				S R <input type="checkbox"/> <input type="checkbox"/>
				S R <input type="checkbox"/> <input type="checkbox"/>
				S R <input type="checkbox"/> <input type="checkbox"/>

33. PROPERTY DAMAGE AMOUNT \$ _____ 34. INSURANCE COMPANY _____

35. OFFICER ASSAULTED Y N 36. ARSON Y N 37. STRUCTURE CODE _____ 38. DAMAGE \$ _____

47. CIB	ENTERED <input type="checkbox"/>	CANCELLED <input type="checkbox"/>	48. TOTAL AMOUNT PROPERTY STOLEN \$ _____
NCIC	<input type="checkbox"/>	<input type="checkbox"/>	49. TOTAL AMOUNT PROPERTY RECOVERED \$ _____
OTHER BROADCAST	<input type="checkbox"/>	<input type="checkbox"/>	

50. IS REPORT CONTINUED? YES NO

51. CAUTION INDICATORS, ATLS ETC.

52. DATA PROCESS INFORMATION:

COMPUTER ENTERED DATE 16/09/99
 MICROFILM INDEXED INITIAL KS

53. FILE APPROVAL

BY [Signature] DATE 10/11/2009

IS CASE CLASSIFICATION CORRECT?
 IF N HAS CORRECTION BEEN MADE?

Y N
N

1. CASE # S99 No 01810 2. CLASSIFICATION 6310.1 3. CENSUS 7,000.0

4. INCIDENT: Crime Stoppers S99-00242

5. INCIDENT LOCATION: Information from FBI Office Chicago

6. NAME - LAST - FIRST - MI: Agent [REDACTED] 7. D.O.B. [REDACTED]

8. ADDRESS [REDACTED] 9. TX-HOME [REDACTED]

11. CITY [REDACTED] STATE [REDACTED] ZIP [REDACTED] 10. TX-BUSINESS [REDACTED]

12. DETAILS: Agent [REDACTED] is assigned Chicago office went home to the Oconto Co. area for a visit over the weekend and was approached by a Anon. source who had information about a Suspect in a Hit and Run Accident taking place somewhere between Oconto and Chicago.

03 02 99 1420Hrs

MANITOWOC COUNTY SHERIFF INCIDENT CARD

18. ASSIGNED: Bushman [REDACTED] MTSO 929

19. REC. BY: MJB 20. DIS. BY: MJB

21. HOW REC'D: 1. 911 2. POLICE RADIO 3. PHONE 4. CITY 5. IN PERSON 6. ON VIEW 7. OFF. OFF DUTY 8. C.B. RADIO 9. OTHER

22. TYPE OF REPORT: 1. INCIDENT 2. ACCIDENT 3. CITATION 4. NONE

23. STATUS: 1. UNFOUNDED 2. PNL 3. OTHER 4. CLEARED 5. EXCEPT CLEARED

24. DATE CLEARED: 10/4/2/99

25. OFFENSE TYPE: 1. ADULT 2. JUVENILE 3. UNKNOWN

14. REC'D 15. DISP 16. 10-23 17. 10-24

13. DAY: SUN 1 THU 5 MON 2 FRI 6 TUE 3 SAT 7 WED 4

39. (CODE S-SUSPECT W-WITNESS V-VICTIM O-OTHER)

CODE	40. NAME - LAST FIRST MI	41. D.O.B.	42. ADDRESS	43. TELEPHONE
0	[REDACTED]		FBI Office Chicago	[REDACTED]
0	[REDACTED]		FBI Office Green Bay Office	[REDACTED]
0	Janssen, Michael		Oconto Co. SO [REDACTED]	[REDACTED]
0	Fischer, Rick		Charleston PD, Ill.	[REDACTED]
0	Stahl, Michael		DNR Warden Oconto County	[REDACTED]
0	WARNER 178582	DALLAS	[REDACTED] 5th St, Charleston IL 61920	
0	WARNER 178583	BEATRICE	[REDACTED] 5th St, Charleston IL	
0	WARNER 178584	HEITH M	[REDACTED] CTH K, Oconto Falls 54154	
0	WARNER 178585	JENNIFER R	[REDACTED] CTH K, Oconto Falls	
0	WARNER 178586	JOHN R	[REDACTED] Rt 1, Box [REDACTED], Lerna IL 62444	
0	WARNER 178587	ROBERT D	[REDACTED] Sunny Brook Rd, Lena	

03/02/99 @ 1420 Hrs.: I, Lt. M. Bushman, took a phone call from FBI Agent [REDACTED] out of the Green Bay Office. He advised he had a note from Agent [REDACTED] who is formerly an Oconto Co. resident and is currently an FBI agent working out of the Chicago Office. [REDACTED] was home to Oconto Co. over the weekend for a visit with family members.

While there, an anonymous source contacted him, stating they had information reference TERRANCE and JENNIFER WARNER living in the Oconto Falls area. JENNIFER WARNER relayed a conversation that she was privileged to to friends saying that her husband's brother was involved in a hit and run accident after leaving Oconto Co. and heading to Chicago. He allegedly struck and killed someone walking on the roadway and did not stop, continuing south to IL; however, he has no idea as to the exact location where that accident took place as he was intoxicated. The suspect vehicle is currently in a garage in IL.

[REDACTED] did not have any answers to specific questions, and [REDACTED] was not available right at this time. [REDACTED] offered his assistance in investigating and follow-up, stating he was tied up for the remainder of today; however, tomorrow would be good to begin. [REDACTED] also advised the Investigator for OCSO, MICHAEL JANSSEN, had been notified by [REDACTED] and was checking the Oconto Co. connection, looking for a location of JENNIFER WARNER.

03/02/99 @ 1630 Hrs.: Contact was made by phone with MICHAEL JANSSEN to verify whether he

S99 No 01810

PROPERTY VALUE

45. IF COMPLAINANT DIFFERENT THEN CALLER, ENTER NAME, ADDRESS, D.O.B., TELEPHONE.

46. IF CODE O (OTHER) IS USED IN FIELD #39, EXPLAIN.

INCIDENT REPORT: NOTE: IF SECTION 22 ABOVE HAS NUMBER 4 CHECKED, DO NOT GO BEYOND THIS LINE WITHOUT RECORDS SECTION BEING ADVISED, OR NO RECORD ENTRIES WILL BE MADE BELOW THIS LINE.

PROPERTY VALUE	26. PROPERTY	A. CURRENCY	B. JEWELRY	C. FURS CLOTHING	D. VEHICLE (LOCAL)	E. OFFICE EQUIPMENT	F. RADIO, TV CAMERAS	G. FIREARMS	H. HOUSE-HOLD GOODS
	STOLEN	\$	\$	\$	\$	\$	\$	\$	\$
	RECOVERED	\$	\$	\$	\$	\$	\$	\$	\$
	26. PROPERTY	I. CONSUM-ABLES	J. LIVESTOCK	K. DRUGS	L. MARINE ITEMS	M. CONSTRUCTION ITEMS	N. LAWN AND GARDEN	O. SPORTING GOODS	P. MISC BICYCLE
STOLEN	\$	\$	\$	\$	\$	\$	\$	\$	
RECOVERED	\$	\$	\$	\$	\$	\$	\$	\$	

27. PROPERTY RECOVERED: LOCALLY _____ OTHER JURISDICTION _____ (INSERT O OR L)

PROPERTY ITEMIZATION	PROPERTY STOLEN/RECOVERED ITEMIZATION, USE THE FOLLOWING FORMAT				
	28. QUANTITY	29. ARTICLE NAME	30. BRAND NAME	31. SERIAL NUMBER	32. CODE
					S R <input type="checkbox"/> <input type="checkbox"/>
					S R <input type="checkbox"/> <input type="checkbox"/>
					S R <input type="checkbox"/> <input type="checkbox"/>
					S R <input type="checkbox"/> <input type="checkbox"/>
					S R <input type="checkbox"/> <input type="checkbox"/>

33. PROPERTY DAMAGE AMOUNT \$ _____ 34. INSURANCE COMPANY _____

35. OFFICER ASSAULTED Y N 36. ARSON Y N 37. STRUCTURE CODE _____ 38. DAMAGE \$ _____

47. CIB NCIC OTHER BROADCAST	ENTERED	CANCELLED	48. TOTAL AMOUNT PROPERTY STOLEN \$ _____
	<input type="checkbox"/>	<input type="checkbox"/>	
	<input type="checkbox"/>	<input type="checkbox"/>	
			49. TOTAL AMOUNT PROPERTY RECOVERED \$ _____

50. IS REPORT CONTINUED? YES NO 51. CAUTION INDICATORS, ATLS ETC.

52. DATA PROCESS INFORMATION:
 COMPUTER ENTERED DATE 16 29 99
 MICROFILM INDEXED INITIAL KS
 IS CASE CLASSIFICATION CORRECT? IF N HAS CORRECTION BEEN MADE?
 Y N

53. FILE APPROVAL
 BY [Signature] DATE 04/29/99

MANITOWOC COUNTY SHERIFF'S DEPARTMENT
FOLLOW-UP REPORT

Page: 2

CASE NUMBER: 599-01810 CLASSIFICATION: _____

INCIDENT: _____

DATE AND TIME: _____

REPORT CONTINUED:

had located JENNIFER WARNER. JANSSEN advised DALLAS WARNER was located in the property tax rolls of Oconto Co., and the rural route mail carrier had a possible location on JENNIFER. He stated he would know more information on 03/03/99.

03/02/99 @ 1900 Hrs.: I, Lt. Bushman, made contact with local DNR Warden Jung. Attempting to locate possible suspects in Oconto Co. by using DNR game license, boat, snowmobile, and ATV registrations were discussed. Warden Jung advised there does not exist a data base at this point and time for any game licensing in the State of WI. The possibility on any specialty-type requests such as Hunter's Choice or goose permits, the data base would exist. Warden Jung suggested contacting Warden MICHAEL STAHL from the Oconto Co. area as he perhaps would have more luck.

Contact was made by phone with Warden STAHL. He checked with his computer all ATV, snowmobile, and boat registrations finding the last name WARNER; however, it did not match up with the suspects we were looking for. STAHL stated, if we needed that information, a hand check would have to be done of all hunting licenses or fishing licenses issued in Oconto Co. A WARNER coming back to the CTH K address was not located.

03/03/99: Contact was made with Agent [REDACTED] from the FBI Green Bay Office who forwarded information for contact of Agent [REDACTED] in the FBI Chicago Office.

[REDACTED] was contacted by phone, and he relayed the following information reference his anonymous source. He made it very clear this source is extremely close to the suspect in this matter and if any investigation was done from the Oconto Co. area, the source would be immediately identifiable. [REDACTED] stated, while he was in Oconto Co., his anonymous source told him:

"JENNIFER and her husband were in IL the weekend of 01/30/99-01/31/99. On 02/01/99, she had a conversation with a girlfriend in Oconto Co. It was at that time the source overheard that conversation. The conversation in Oconto Co. had to do with the conversation she was privileged to in IL, taking place between her husband, her husband's brother, and her husband's father. JENNIFER did participate in that conversation. The information was that her husband's brother was very drunk when he was involved in the hit and run accident. Immediately upon arriving home, he told his father about the accident. The brother is extremely upset about the matter, and the truck is currently hid in a garage in IL. Her husband's brother and father are very much aware that they (meaning police) are investigating this matter, and the truck has been hidden since the incident. The informant also stated the suspect has been involved in this type of trouble before. There was no mention of Manitowoc or WI reference the hit and run accident."

It was stressed again the source who overheard this information was in the wrong place at the wrong time and if the information were to surface in Oconto Co., the source who wishes to remain anonymous would be easily identifiable.

MANITOWOC COUNTY SHERIFF'S DEPARTMENT
FOLLOW-UP REPORT

Page: 3

CASE NUMBER: 599-01810 CLASSIFICATION: _____

INCIDENT: _____

DATE AND TIME: _____

REPORT CONTINUED:

03/03/99 @ 1045 Hrs.: Contacts were made for the next several hours with the first four investigators on the complaint and the following information has been assembled:

DALLAS and BEATRICE WARNER are the grandparents who are on the property tax roll in Oconto Co. Their one time address was [REDACTED], CTH K, Oconto Falls. Current address is [REDACTED] 5th St, Charleston, IL.

MARK WARNER and STEVEN WARNER are sons of DALLAS and BEATRICE. Both are now living in IL. No address for MARK currently; however, he did at one time live in Oconto Co. STEVEN currently lives at Rt 1, Box [REDACTED], Lerna, IL 62444, phone of [REDACTED].

HEITH WARNER is the son of MARK and is married to JENNIFER WARNER. He has an FBI number which ties him to Mattoon and Charleston, IL. A subsequent check with Charleston PD in IL showed HEITH had been arrested in the past with DALLAS and BEATRICE bonding him out of Jail. DALLAS is HEITH'S grandfather. Also, with Charleston PD, there is a record of HEITH involved in a DV complaint with his wife, JENNIFER (the DOBs are the same). Both HEITH and JENNIFER currently live at [REDACTED] CTH K, Oconto Falls. It is believed JENNIFER is the source of the conversation which generated this complaint.

JOHN WARNER is believed to possibly be the brother of HEITH and possibly the suspect we are currently looking for in this hit and run accident; however, in checking with Charleston PD, it was learned JOHN is a suspect in a hit and run accident fatality in Charleston, IL, which occurred on 01/17/99. JOHN'S father is STEVEN. In speaking with Lt. RICK FISCHER of Charleston PD; it was learned the fatality hit and run accident took place on 01/17/99 with several witnesses on the scene. JOHN turned himself in the following day, 01/18/99, when he walked into the PD with his attorney. He only gave information that he was the driver of the vehicle at the time of the incident and would not elaborate about his level of intoxicating beverage or any other details. Charleston PD intended to lock JOHN WARNER up; however, they worked out a deal with his attorney that JOHN was allowed to remain on the street, in exchange for the suspect vehicle which is involved in the hit and run accident. Lt. FISCHER stated the suspect vehicle was a 1984 Buick Century and currently in their Impound. JOHN made no attempt to clean up the vehicle, and blood and hair was found matching that of the victim in their hit and run fatality. An arrest warrant should be issued within a short period of time for JOHN WARNER, possibly Friday of this week.

Contact was made with Special Agent [REDACTED] a second time. One would think with the information about JOHN WARNER being involved in a fatal hit and run in IL, this would pretty much close out my complaint; however, [REDACTED] made contact with his anonymous source again. There are 2 serious conflicts--one being that the conversation regarding a hit and run accident did definitely involve a truck and the other being that the conversation took place on 01/30/99 with the suspect vehicle still being hidden 12 days after JOHN WARNER turned himself in to Charleston PD (they recovered the suspect vehicle at

MANITOWOC COUNTY SHERIFF'S DEPARTMENT
FOLLOW-UP REPORT

Page: 4

CASE NUMBER: 599-01810 CLASSIFICATION: _____

INCIDENT: _____

DATE AND TIME: _____

REPORT CONTINUED:

that time). Information from Charleston PD is that the WARNER family lives in a remote part of Cumberland Co. and that the family is quite large with numerous OWI arrests, DVO arrests, alcohol-related arrests, and general drinking violations for all members of the family. There is a possibility there is a second WARNER involved in the hit and run accident here in Manitowoc. It should also be noted, on JOHN WARNER'S arrest sheet and HEITH WARNER'S arrest sheet, both have places of birth listed as Oconto Falls, WI.

During one of the return phone calls from MICHAEL JANSSEN, the OCSO Investigator, he stated he located JENNIFER R. WARNER and was almost sure we had the correct JENNIFER. He made contact with a neighbor who stated the WARNERS are not well-liked by any of the neighbors in Oconto Co. which was also echoed from the original complaint. He also stated the neighbor told him every weekend, generally 2 vehicles with IL RPs, usually trucks, come to Oconto Co. One of the brothers of the resident in Oconto Co. was described as being a very unpleasant individual. JANSSEN also located several other individuals with the last name of WARNER and would be looking into their information to see if they tie in to this complaint. A photocopy of the first 8 pages of the complaint was faxed to the FBI Office in Green Bay, attention Agent [REDACTED], who will be accompanying JANSSEN on 03/04/99 to follow-up on the investigation.

The last contact by phone was made with Agent [REDACTED] in the FBI Chicago office. [REDACTED] requested the names of all the WARNERS who we had ties to Oconto Co. He was going to use the FBI computer system to attempt to locate all vehicles listed to those individuals and will do further checking for a possible brother to HEITH WARNER with that brother living in either the Charleston or Cumberland Co. area in IL. MJB [REDACTED] /bjc

03/04/99 1120hrs Contact made by phone with Det. Fischer Charleston PD. He advised contact was made with the Sheriff of Cumberland County. Warners live in the very small community of Johnson Town but have a rural route address of Lerna. There is a large group of tight knit family of Warner, who get suspicious if theres any poking around in their secluded area. Det. Fischer stated "We should be able to come up with something". Request made to find out who Heith's father and any brother's names. Fischer will call back with list of names when he is completed followup, "tomorrow or Monday" [REDACTED] TASK FORCE [REDACTED]

03/04/99 1309hrs Phone call received from Special Agent McClaren Ill.State Police. He has been assigned to assist with identifying Heith Warner's Brother and father and locating them. Information about the Comp. passed on. He has Drug Officer's undercover working area who may know the Warner family. M.J. Bushman [REDACTED]

03/05/99 1530hrs [REDACTED] FBI Green Bay called, Warner residence is located and arrangements made to watch for Ill.Registrations this weekend. M.J. Bushman [REDACTED]

- 0 WARNER 178588 MARK J [REDACTED] Beebe Rd, Hazel Green WI [REDACTED]
- 0 LEMANSKI 178589 JESSIE J [REDACTED]
- 0 LEMANSKI 178590 DENNIS JR J [REDACTED]

MANITOWOC COUNTY SHERIFF'S DEPARTMENT
FOLLOW-UP REPORT

Page: 5

CASE NUMBER: 599-01810 CLASSIFICATION: _____

INCIDENT: _____

DATE AND TIME: _____

REPORT CONTINUED:

03/08/99: At this point and time, no information has been received from IL State Police, Agent McClaren.

03/08/99 @ 1328 Hrs.: I, Lt. M. Bushman, made contact by phone with [REDACTED] from the FBI Office in Chicago. He has no new information to add to this complaint.

In our last phone conversation, we discussed possible approach information to give to the WARNERS for the reason of our interview in Oconto Co. It was agreed we would basically begin saying:

*** The hit and run investigation initially took on an area of coverage within Manitowoc Co., soon expanding to a 5-county area, and eventually to a 3-state area.

*** We have been aggressively pursuing all possible leads in tracking down the person(s) responsible for this very unfortunate and tragic accident in Manitowoc Co. in January 1999.

*** What brings us to Oconto Co. is the fact that JOHN WARNER was arrested in IL on a hit and run felony charge and will be facing charges there as a result of that accident.

*** In connection with the investigation in IL, the investigators down there found that JOHN WARNER had been born and raised in Oconto Falls and recently had traveled back and forth to visit family members. The close timing of these 2 unfortunate accidents makes it quite simply necessary for us to follow-up on any possible leads which would help resolve the accident in Manitowoc Co.

*** Investigators are:

Curious as to any of the WARNER families who traveled to Oconto Co. or were returning on the weekend of 01/09/99 through 01/10/99;

Curious of what time that person would have left;

Curious of what they had been drinking; and

Curious of what type of vehicle that person may have been driving.

[REDACTED] also read his original notes, again stating this is entirely conceivable that this is related or evolved around JOHN WARNER'S accident. There was a statement that "he has been involved in this type of accident before." JOHN WARNER has had previous hit and run with injury accidents.

Contact was made with FBI Agent [REDACTED] in the Green Bay Office. He advised he is not going to be available until after 03/16/99 to assist with interviews.

MANITOWOC COUNTY SHERIFF'S DEPARTMENT
FOLLOW-UP REPORT

Page: 6

CASE NUMBER: 599-01810 CLASSIFICATION: _____

INCIDENT: _____

DATE AND TIME: _____

REPORT CONTINUED:

I, Lt. Bushman, made contact by phone with MICHAEL JANSSEN in Oconto Falls. Arrangements were made for him to assist with interviews on 03/15/99. He advised there were no IL vehicles at the WARNER residence over the past weekend.

HEITH WARNER lives in a trailer house on a 1-acre plot, immediately adjacent to his grandfather's (DALLAS WARNER'S) 40 acres on CTH K. HEITH works in Shawano from 0600-1400 hours.

JENNIFER WARNER, HEITH'S wife, works in Suring from 1500-2300 hours but is currently out of work with a back injury.

ROBERT WARNER is HEITH'S brother. ROBERT has a child and lives with JESSIE LEMANSKI on Sunny Brook Rd, just north of Lena. He works in the LENA LUMBER YARD from 0700-1500 hours.

03/15/99 @ 1030 Hrs.: I, Lt. Bushman, along with Deputy P. Herrmann made contact with DET. MICHAEL JANSSEN at OCSO in the Briefing Room. We compared notes and reviewed the map for the suspect's residence location.

03/15/99 @ 1200 Hrs.: Attempted contact with JENNIFER WARNER at [REDACTED] CTH K. The residence is a trailer home on the west side of the road. There was no movement in the residence while knocking.

Also on the property is a 3-car metal garage with a woodworking shop on the north end. The garage door was standing open. No movement was noted in the garage or the 1-acre yard which is fairly free of obstruction. Inside the garage was one older Jeep Cherokee (RP was not visible). Nothing suspicious in the line of extra auto parts that may be similar to the type of vehicle we are looking for was observed lying about. There were 2 IL RPs hanging in the rafters--PKE503 and personalized MADLEM3. Neither one of these RPs come back on the teletype as being current.

The \$25,000 reward posters were placed in the mini-mart and gas station near the KELLY LAKE RECREATIONAL AREA.

03/15/99 @ 1220 Hrs.: A second check was made at this residence. Officers went down the road to the south and waited for approximately 10 minutes. No one was observed coming or going from the residence.

Posters were then dropped off in the bank, mini-mart, beauty shop, and grocery store in Suring. A stop was made at JENNIFER'S employer. It was learned she is due back to work at 1500 hours.

03/15/99 @ 1258 Hrs.: A drive-by was completed at [REDACTED] CTH K. A 4-door Plymouth vehicle was observed in the driveway. Upon approach to the trailer home, a male party identified as HEITH WARNER exited his home and locked the door behind him. HEITH was just back from the dentist as he had a tooth pulled on the right side. Swelling and a drooping from the novocaine was noted. He was on his regular day off as he had worked Saturday.

MANITOWOC COUNTY SHERIFF'S DEPARTMENT
FOLLOW-UP REPORT

Page: 7

CASE NUMBER: 599-01810 CLASSIFICATION: _____

INCIDENT: _____

DATE AND TIME: _____

REPORT CONTINUED:

All 3 of us identified ourselves as police officers, and a request was made for an interview. HEITH was reluctant to invite us into his home or travel to OCSO. The interview was conducted by Deputy Herrmann on the wood steps of this residence beginning at 1301 hours.

HEITH stated he heard rumors that we were coming to talk with him. He advised he only knew what he read in the newspaper about JOHN WARNER'S accident. JOHN has not been to WI for over a year and not more than twice since HEITH and JENNIFER first moved here in 1996. No other relatives have been up to visit, and HEITH and JENNIFER visit only once a year to IL, that being between Thanksgiving and Christmas. They do not own or have access to a Chevrolet pickup, Blazer, Suburban, or van. HEITH has one friend from Charleston, IL, with a Chevrolet pickup, description unknown. HEITH went on to state that this friend has not been to WI for over a year. HEITH asked how long this interview would take as he had an appointment with a friend. It was noted, at 1311 hours, HEITH'S hands were shaking slightly. I suspected it was from the cold as he did not have a coat on.

HEITH'S parents, MARK and CONSTANCE, are from the SW corner of the State near Hazel Green. They recently were to the Oconto address; however, the exact date was not recalled, some time late January or early February. They were up just for the weekend visit and stayed with HEITH and JENNIFER but were gone most of the time visiting friends and relatives. MARK at one time did live in Oconto Co., just south of HEITH'S current home, 0.3 miles away. HEITH pointed to the south, to a white home on the hill on the east side of CTH K, stating, "That's where I grew up." HEITH also stated he is not real close to his parents. They did not talk about JOHN WARNER'S accident and arrest but when asked again, HEITH stated it was brought up several times with short remarks about the newspaper clippings.

HEITH stated he grew up with JOHN and was close with him but has recently drifted apart since high school. He did not want to tell us anything about the accident because of the pending action against JOHN, stating, "I don't know anything more than the newspaper articles." HEITH was asked if the accident was hard on the rest of the WARNER family living in IL. HEITH stated they all pretty much keep to themselves, and they are not a tight-knit family. JOHN is close to his father, STEVEN, and in fact lives with him. HEITH stated, "JOHN probably told his dad as soon as he got home. This is definitely not an intentional act."

03/15/99 @ 1323 Hrs.: HEITH'S knees were slightly shaking, and he looked quite cold. As we were about to wrap up the interview, another vehicle pulled into the yard with 2 adult females and 2 children. They were identified as JENNIFER WARNER driving and JESSIE LEMANSKI. A request was made of HEITH to interview his wife, JENNIFER, and that HEITH and JENNIFER do not discuss any of our conversation before we have a chance to talk with her. HEITH was questioned about where I could meet with his parents. He promised to retrieve an address book for me. He happened to enter the residence about the same time JENNIFER was escorting their small child inside. Officers were uncomfortable that they were together without a witness. Deputy Herrmann requested to use the bathroom in the residence. Both HEITH and JENNIFER came out almost immediately. Deputy Herrmann and HEITH then gave JESSIE a ride home which was about 12 miles away.

MANITOWOC COUNTY SHERIFF'S DEPARTMENT
FOLLOW-UP REPORT

Page: 8

CASE NUMBER: 599-01810 CLASSIFICATION: _____

INCIDENT: _____

DATE AND TIME: _____

REPORT CONTINUED:

03/15/99 @ 1349 Hrs.: DET. JANSSEN and I (Lt. Bushman) were invited into the residence. We sat at the kitchen table to conduct an interview with JENNIFER. The residence was very clean and orderly. JENNIFER appeared to be uncomfortable, stating she has not talked much with police in the past and nervously cleaned up a few breakfast articles on the counter and found a video tape for her 5-year-old daughter to watch.

JENNIFER eventually sat down at the table to talk with us. We began with the same explanation that we had given her husband, HEITH. JENNIFER verified almost word-for-word what HEITH told us; yet, it did not sound as if it was rehearsed. She stated JOHN and HEITH grew up together and were very close, "like brothers," more so than HEITH'S own brother, ROBERT. She stated, when the newspaper article first arrived, it was upsetting to HEITH. When JENNIFER came home from work, she could tell that obviously something was on HEITH'S mind that he needed to talk about. He was upset. It lasted for a few days, but they managed to talk it out together.

I told JENNIFER it was a wonderful gesture on her part to be there for her husband in this time of need. I then inquired if she had any family or close friends who she could talk with. She told me her family all lived in IL and that she had very few friends, but she did confide in a special friend who she used to work with, but this person has recently moved away. That female friend (first name of BONNIE) has opposite hours of hers, so talking is sometimes not an option. JENNIFER typed and sent BONNIE some E-mail. The topic was about JOHN'S hit and run accident.

The only relatives who had recently been to visit the WARNERS were HEITH'S parents from Hazel Green, WI. Out of curiosity, I asked what type of vehicles they drove. JENNIFER stated they have a small 4-door Pontiac and a Chevrolet pickup truck. JENNIFER stated she absolutely did not know which vehicle they brought up for the visit; however, more than likely, it was the Pontiac as that is the normal vehicle they drive in the winter months.

JENNIFER retrieved a newspaper article from Charleston, IL, with the title "Man Confesses to Fatal Hit and Run Accident." It was a description of JOHN WARNER of rural Lerna who turned himself in to police after the hit and run accident. It gave a brief description of the accident and that he had turned himself in with an attorney the following day. The vehicle involved was a 1984 Buick Century which was also in custody for processing of evidence.

The newspaper article was taken to the KELLY LAKE MINI-MART, photocopied, and returned. HEITH and Deputy Herrmann did return from delivering JESSIE to her residence. HEITH shook our hands prior to leaving and appeared to be much more relaxed as he had the opportunity to speak with Deputy Herrmann while traveling back from the LEMANSKI residence.

03/15/99 @ 1530 Hrs.: All 3 investigators traveled into Oconto Falls to a restaurant for lunch. It was agreed, after lunch, we would attempt to make contact with ROBERT WARNER at his residence at [REDACTED] Sunny Brook Rd as long as we were still in the Oconto Co. area. The interview with HEITH and ROBERT will appear in the report addition by Deputy Herrmann.

MANITOWOC COUNTY SHERIFF'S DEPARTMENT
FOLLOW-UP REPORT

Page: 9

CASE NUMBER: 599-01810 CLASSIFICATION: _____

INCIDENT: _____

DATE AND TIME: _____

REPORT CONTINUED:

Officers traveled to ROBERT WARNER'S residence at [REDACTED] Sunny Brook Rd where we conducted an interview. There was a steel shed with 4 car garage doors and a walk-through door which belonged to DENNIS LEMANSKI, the brother of ROBERT'S live-in girlfriend, JESSIE LEMANSKI. Apparently, the property at [REDACTED] Sunny Brook Rd belongs to DENNIS LEMANSKI who is in the process of selling it to ROBERT. The garage is off-limits to ROBERT. JESSIE stated several times that we could go into the garage; however, the doors were frozen shut. She then stated she did not have a key. Eventually, a key was obtained from the next door neighbor (DENNIS LEMANSKI, SR.); however, even with the keys, the doors were definitely froze shut. DENNIS SR. said, "Go ahead and try and get in, but if you break something, you'll have to repair it."

03/16/99 @ 1220 Hrs.: JESSIE LEMANSKI called MTSO and requested to speak with me, Lt. Bushman. Her brother, DENNIS LEMANSKI, came to [REDACTED] Sunny Brook Rd. He was standing by and wished to inform me that he would be cooperative in allowing officers to make entry to his building; however, it was froze at this time.

I, Lt. Bushman, then spoke with DENNIS and requested maybe some salt or Mr. Melt would take care of the ice or a little bit chipping. He stated he could probably have the walk-through door opened. He stated he would get a hold of DET. JANSSEN from OCSO when the door could be opened and have him do a walk-through of the garage with DENNIS. DENNIS stated there should be a 1979 Firebird, a 1974 Buick Apollo, a 1993 Suzuki 1400, and various fishing and hunting equipment in addition to yard tools stored in the shed. Again, DENNIS wanted to make sure that officers knew he would be cooperative if they came out to view what was in the garage. It was stressed upon him that nothing is to be removed prior to officers walking in, especially anything that would lead tire tracks coming or going through the snow on the north side of the building.

The phone was then turned over to JESSIE LEMANSKI. JESSIE wished to instruct me that her husband definitely was not involved in the hit and run accident and that officers were wrong in their pursuit in accusing him as being the suspect. She stated she works from 0500-1700 hours on all weekends and her husband works during the week. When she is gone working on the weekends, he spends 90% of his time as a "couch potato" watching TV and the kids. She wished to also state that officers bringing MICHAEL JANSSEN along to the interview was the worst person we could possibly bring as JANSSEN is known throughout Oconto Co. as being an OCSO investigator. She suggested her husband was probably very nervous about his presence and that is more than likely what caused him to act somewhat indecisive in his answering of questions. I advised her, if officers could return and conduct another interview, we would not bring JANSSEN with us if that would make ROBERT more comfortable. JESSIE stated, if we returned, ROBERT would be getting an attorney to be present with questioning.

03/17/99 @ 1257 Hrs.: Agent McClaren from IL State Police called MTSO; however, the Dispatcher indicated they got disconnected before any information could be passed along. Apparently, he did not call back.

03/20/99: Contact was made by phone with the City of Shawano PD. I spoke with Sgt.

MANITOWOC COUNTY SHERIFF'S DEPARTMENT
FOLLOW-UP REPORT

Page: 10

CASE NUMBER: 599-01810 CLASSIFICATION: _____

INCIDENT: _____

DATE AND TIME: _____

REPORT CONTINUED:

Brodhagen, phone of [REDACTED] Sgt. Brodhagen was advised that I (Lt. Bushman) am looking for a young lady working for a chiropractic office in the City of Shawano, first name of BONNIE. I informed him I was interested in an address or phone number. I also informed him I would be interested in interviewing the young lady face-to-face if possible.

03/20/99 @ 1300 Hrs.: Sgt. Brodhagen called back, stating all chiropractic offices were closed today; however, he does know some outside sources who would possibly be able to identify BONNIE. He said he would get back to me on Monday, 03/22/99.

MJBushman *[Signature]* /bjc

03/15/99: I, Deputy P. Herrmann, along with Lt. M. Bushman made arrangements with OCSO, Detective Division, to meet with them in an attempt to locate ROBERT WARNER.

We were successful in meeting ROBERT at his residence at which time I introduced us as police officers to which ROBERT stated he understood. I asked ROBERT if he would be able to cooperate with us reference this incident to which he stated he would. I asked ROBERT if he had any idea why investigators were at his residence to which he stated it may be in reference to a hit and run, resulting in the death of a small girl. I asked ROBERT if he could elaborate to which he stated, "Yes, the hit and run in Manitowoc County," where he thought a young girl was killed.

I asked ROBERT where he learned of this information to which he stated there has been a rumor going around the Oconto area that investigators are wishing to speak with the WARNER family reference this incident. ROBERT, at first, indicated he did not see anything on TV to the effect of this hit and run under investigation in Manitowoc Co.; however, he later changed his story and stated he did see this case on Channel 5 TV. ROBERT stated he was forewarned by his brother via a telephone contact that investigators were in the area and in the process of locating members of the WARNER family to question.

I asked ROBERT if he had any information regarding this investigation to which he stated no. I asked ROBERT if he had any idea who might be responsible or involved in this hit and run fatality to which he stated no. I asked ROBERT if he would be willing to submit to an examination by the voice stress analysis truth verification technique to which he stated yes. I then instructed ROBERT that I had a unit along with me and that we could take care of this examination on the spot to which he stated today would not be a good day for that examination. ROBERT stated he felt he was too nervous at this time and that a valid test probably would not be obtained due to his level of nervousness.

After explaining to ROBERT that I was not forcing him to take this examination and that it would be an opportunity for him to prove he was telling the truth on this matter, ROBERT stated he would then submit to this examination. ROBERT read and signed the truth verification release form.

I walked with ROBERT over to his next door neighbor who happens to be his father-in-law for purposes of conducting this examination indoors. Permission was granted from the father-in-law to use in the kitchen area of his residence for this examination.

MANITOWOC COUNTY SHERIFF'S DEPARTMENT
FOLLOW-UP REPORT

Page: 11

CASE NUMBER: 599-01810 CLASSIFICATION: _____

INCIDENT: _____

DATE AND TIME: _____

REPORT CONTINUED:

I, Deputy Herrmann, asked ROBERT prior to the examination how he felt the results of this examination would come out on him to which he stated, "I hope that the result would show that I am innocent or have no knowledge of who is responsible for this hit and run fatality."

I conducted an examination on ROBERT. Results of the examination revealed ROBERT showed deception on a portion of the relevant questions to this hit and run fatality. I advised ROBERT it was my opinion that he was being deceptive on certain questions to which he stated he understood; however, he did not wish to explain why this may have occurred, other than he felt the equipment was faulty. ROBERT became increasingly nervous and became reluctant to answer any further questions after the examination.

ROBERT stated he no longer wanted to participate in this investigation and asked if he could leave to which I stated yes. ROBERT then left the residence and returned to his property. This information was shared with Lt. Bushman. PHerrmann /bjc

O	TOLZMAN	BONNIE	J	██████████	██████████	Fust Rd, Gillett 54124	██████████
O	TOLZMAN	JEFFREY	J	██████████	██████████	Fust Rd, Gillett 54124	██████████

03/21/99 @ 0800 Hrs.: I, Lt. M. Bushman, made contact by phone with MARK and CONSTANCE WARNER at ██████████ Beebe Rd, Hazel Green, WI. Hazel Green is located approximately 20 miles to the east of Des Moines, IA, and probably about 5 miles north of the State line. An appointment was made for the early afternoon.

03/21/99 @ 1300 Hrs.: The drive to Hazel Green is 230 miles, to the WARNER residence which is located in the southern WI hills of Lafayette Co. Authorities were notified by radio of my location should I need backup.

The property is a neat, secluded small farm with a renovated, older farm home. MARK WARNER met me at the door and invited me in, walking toward the kitchen, introducing me to his wife who was already seated at the table. After introductions were completed, MARK viewed my ID and badge.

The same explanation was given to MARK as to why we were interviewing the WARNER family, and it irritated MARK somewhat, causing him to state, "I didn't quite understand what my sons were trying to tell me when they phoned me about your interview. Tell me you have more reason than that to question my sons. President Clinton was on the TV recently saying no man has the right to discriminate against anyone because of race, religion, or name; yet, because one of my relatives was involved in a terrible act, my sons are being questioned. Did you bother to check if any of us have any vehicles matching that description?" MARK was advised the information of the act of his nephews must have been repeated by his sons or their wives/girlfriends because we were acting on an anonymous Crime Stoppers complaint from someone who had either overheard part of JOHN WARNER'S hit

MANITOWOC COUNTY SHERIFF'S DEPARTMENT
FOLLOW-UP REPORT

Page: 12

CASE NUMBER: 599-01810 CLASSIFICATION: _____

INCIDENT: _____

DATE AND TIME: _____

REPORT CONTINUED:

and run and suspects it may have been related to Manitowoc Co.'s hit and run because of the heavily publicized Manitowoc Co. complaint.

I, Lt. Bushman, displayed a wanted posted and told him the WI Most Wanted Program on Channel 11 was viewed in the Oconto Co. area. MARK then stated, "That explains it. You certainly had to follow-up." The conversation then turned toward JOHN WARNER growing up with MARK'S sons in Oconto Co. MARK reached for several old photographs that were hanging on the refrigerator which showed MARK with his sons, HEITH and ROBERT, and JOHN, playing basketball in the driveway of MARK'S Oconto Co. home. MARK no longer owns a home in Oconto Co., and all the parties appeared to be much younger on the photograph. MARK stated "they" (meaning ROBERT, HEITH, and JOHN) were very close when they grew up.

I advised MARK I was most interested in any conversations that took place reference JOHN'S hit and run accident the weekend he and CONSTANCE went to visit in Oconto Co. MARK stated, in January, they went to FL for a vacation for 2 weeks. They left around 01/13/99. While enroute to FL, they stopped to visit MARK'S parents, DALLAS and BEATRICE WARNER, in IL. At that time, everything was quiet in the family, and nothing disturbed was reported.

While in FL, MARK and CONSTANCE learned of JOHN'S hit and run accident by a phone call. They knew very few details until they returned from FL and then went to Oconto Co. to visit HEITH and JENNIFER. At that time, they read newspaper accounts from IL that were mailed to HEITH and JENNIFER'S home in Oconto. They talked a little about the accident, but there was no extensive conversations, "not more than a few words." MARK stated he knew nothing about the Manitowoc Co. hit and run until HEITH called him after we interviewed him and ROBERT on 03/15/99.

I pointed out the 03/02/99 date on the Crime Stopper complaint, stating someone would have had to talk about this and that someone had either intercepted that information and changed the story by adding information from both complaints or someone may have overheard the conversation, not getting all the information about the WARNER accident and somehow felt it had to do with Manitowoc Co.'s because of the great publicity.

MARK then turned to CONSTANCE who immediately turned toward him and stared back. It was obvious they were both thinking the same thought, with a look on their face like suddenly this all made sense. MARK stated, "JESSIE! She's untrustworthy. My son and JESSIE are not married. They live together and have a child. She has always lied and told stories. She's got a big mouth."

JOHN told me the weekend they were in Oconto Co., that Saturday night, ROBERT came to HEITH'S house upset and very mad. His girlfriend, JESSIE, did not come home Friday night after work. She spent the night drinking and had an affair with an OCSO deputy. Apparently, she had not been home as of Saturday when ROBERT came over, and ROBERT wanted HEITH to go with him to a Kelly Lake bar that he heard JESSIE was at and "kick that deputy's butt." MARK talked his sons out of it, and they did not confront the deputy.

MARK stated. "It spoiled our whole weekend. JESSIE would do anything for \$25,000. Neither

MANITOWOC COUNTY SHERIFF'S DEPARTMENT
FOLLOW-UP REPORT

Page: 13

CASE NUMBER: 599-01810 CLASSIFICATION: _____

INCIDENT: _____

DATE AND TIME: _____

REPORT CONTINUED:

of my sons would live with themselves knowing they killed someone. They would tell me, and we'd do the right thing, just like JOHN did."

MARK stated he was glad I (Lt. Bushman) could come and talk with him. The interview lasted approximately 50 minutes.

03/22/99 @ 0755 Hrs.: Sgt. Brodhagen from Shawano PD called and stated he had information I requested as to who BONNIE would be working at a local chiropractor.

A call was returned to Sgt. Brodhagen who stated, at the COUNTRY SIDE CLINIC, just on the edge of Shawano, a young lady by the name of BONNIE who lives in Oconto Co. does work there as a reception. Her name was BONNIE TOLZMAN who is married to JEFFREY TOLZMAN. They live at [REDACTED] Fust Rd, Gillett. Apparently, BONNIE works from 1200-2000 hours.

03/22/99 @ 1200 Hrs.: Contact was made with BONNIE TOLZMAN at COUNTRY SIDE CLINIC. She was asked if it would be more comfortable if I called her at home or if she could provide me with 10 minutes of time. She stated it was quiet at this moment and she could talk on the phone.

I determined that BONNIE does in fact know JENNIFER WARNER and they did work together at one time. They correspond back and forth on the phone and with E-mail. She advised she did recall the conversation I inquired about; however, she was unable to tell me exactly when it took place. She stated it was quite some time ago and would hesitate to venture what the date was. She stated, "All I remember is that JENNIFER'S husband's (HEITH'S) cousin, JOHN, killed a college student. It was at night, and he didn't turn himself in right away."

BONNIE stated she talked to JENNIFER by phone when she gave her the information. She said HEITH was apparently very upset because he was close to his cousin when they were growing up. BONNIE stated it was late January or early February when the conversation took place, but she did not have a day. BONNIE stated she had not told anyone other than her husband and now me about that phone conversation. Her husband did not seem to be very curious about the incident at all.

03/22/99 @ 1300 Hrs.: Contact was made with SCOTT STANDFER who works for IL State Police District 12, phone of [REDACTED]. Apparently, Agent McClaren gave STANDFER the information about our hit and run. STANDFER found out where STEVEN WARNER and his son, JOHN, are living and that they have 2 trucks registered to them. One is a 1986 Ford pickup. The other is a 1986 Ford 2-ton truck. No information was found as to the possibility of 2 separate hit and run accidents involving any of the WARNERS.

03/23/99: Attempted contact with MICHAEL JANSSEN from OCSO. He was busy on another matter. I was looking for any information as to whether some information fell off the tree that we shook when we up in Oconto Co. earlier in the week.

After contacting numerous sources and making several trips to interview, it appears to me

MANITOWOC COUNTY SHERIFF'S DEPARTMENT
FOLLOW-UP REPORT

Page: 14

CASE NUMBER: 599-01810 CLASSIFICATION: _____

INCIDENT: _____

DATE AND TIME: _____

REPORT CONTINUED:

as if this complaint and the conversation which was overheard had to do with the accident that took place in Charleston, IL, involving JOHN WARNER. Although there are several questions that still remain to be answered, I do not believe anything has pointed to a WARNER family member being involved in this accident in Manitowoc Co.

The complaint can be closed out. *MJBushman* /bjc

ALL NAMES ENTERED ETC

I 43 S/B GO OVER
 THE MARQUETTE
 INTERCHANGE BRIDGE GET
 OFF ON BRECHER/LINCOLN
 EXIT GO TO LINCOLN +
 TURN LEFT DIST. #
 2 IS AT 2ND + LINCOLN
 PH. # FOR DIST. #2-LT.
 1- [REDACTED] - [REDACTED] - [REDACTED]

IMPORTANT MESSAGE

FOR LT Bushman

DATE 03-22-99 TIME 0755 A.M. P.M.

M. Officer Brod hagen

OF Stoughton P.D.

PHONE [REDACTED]

FAX WORK - 508-214-5111

MOBILE 710 516 6708

TELEPHONED	PLEASE CALL
CAME TO SEE YOU	WILL CALL AGAIN
WANTS TO SEE YOU	RUSH
RETURNED YOUR CALL	SPECIAL ATTENTION

MESSAGE
Found out who Bonnie
is (maybe)

SIGNED

facsimile
TRANSMITTAL

to: Lt. Mike Bushman
fax #: [REDACTED]
re: Possible interview
date: March 11, 1999
pages: 1

Mike,

Here are my suggestions - apologize for not getting it to you sooner... Please excuse the simplistic language - just including it for context... Good luck. Thanks.

Ms. Warner, I'm aggressively pursuing all possible leads in tracking down the person or persons responsible for this very unfortunate and tragic accident in Manitowoc County last January.

What brings us here is the fact that John Warner was arrested down in Illinois on _____ and he's going to be facing charges down there on that accident.

In connection with the accident investigation in Illinois, the investigators down there found out that John use to travel up here to Oconto County to visit you folks, as well as other family members in the area.

The close timing of these two unfortunate accidents makes it, quite simply, necessary for me to follow up on any possible leads which might help me resolve this accident, since logically, John would have had to drive through Manitowoc County in order to get back home to Illinois.

Was he up here the weekend of January 9-10? What time did he leave? Had he been drinking? What was he driving? etc...

One other suggestion I have is to tell her that the two hit and runs occurred on the same date - 1/10. That way, its even more plausible for you to draw the connection and to show up in Oconto County questioning them... Thanks.

From the desk of...

SSA [REDACTED]
[REDACTED], Chicago Division
FBI
[REDACTED]
[REDACTED]

Man confesses to fatal hit-and-run

■ John R. Warner of rural Lerna turns himself in to police Monday

BY DAVE FOPAY
AND ROB STROUD
Staff Writers

CHARLESTON — A rural Lerna man has apparently admitted that he was the driver in Sunday's fatal hit-and-run accident, authorities and the man's attorney say.

John R. Warner, 23, who lives in Cumberland County near Lerna, turned himself in to police about 5 p.m. Monday, shortly after consulting with Charleston attorney Ron Tulin.



Warner

about a half hour after the accident, which occurred early Sunday morning in the 1300 block of Fourth Street in Charleston.

State's Attorney Steve Ferguson said Warner will "most likely" face some sort of criminal charges in connection with the accident.

Grigsby was reportedly walking in the street with four Eastern

Illinois University students: Elena M. Garza of Chicago, Albert R. Lopez of Franklin Park, Lyndsy Paver of Winfield and Tina L. Johnson of Sauk Village. The others were also hit by the car and suffered various injuries. Grigsby was apparently in Charleston to visit Johnson, whom he was dating, but he was not an EIU student.

According to Tulin, Warner wanted to talk with an attorney before going to police. It took some time to contact a lawyer because the accident occurred on Sunday, Tulin said, adding that he met with Warner about 4:30 p.m. Monday.

"The young man feels terrible about this accident," Tulin said Tuesday. "It was an accident. It wasn't intentional."

Stephen A. Grigsby, 22, of Bloomingdale died at Sarah Bush Lincoln Health Center.

"We went down to the police station immediately," Tulin said. He said police didn't consider Warner to be a flight risk, so he wasn't taken into custody. Ferguson said Warner was released pending further investigation but

he had "no reason to believe" Warner was a flight risk.

Ferguson said he wasn't able to say what charges Warner might face because police are still conducting an investigation, part of which is trying to determine Warner's activities prior to the accident.

A news release Ferguson's office prepared Tuesday said anyone with information about Warner's activities and whereabouts Saturday night or early Sunday should call Charleston police at 348-5221.

Warner was described as being about 6-feet 3-inches tall, weighing 145 pounds and having brown hair and brown eyes.

Tulin said Warner was driving home at the time of the accident. Police said on Monday that the driver paused after hitting the pedestrians to see what he had

done before driving away.

"Quite frankly, he just got frightened and left," Tulin said.

The release also pointed out that failing to report an accident involving a death within an hour of it taking place is a felony.

Ferguson said he had "no information one way or the other" about whether Warner was intoxicated at the time of the accident.

Ferguson said police told him that Warner provided them with information required when reporting an accident: the date, time and location of the accident and the registration number of the vehicle driven.

"According to the information obtained, Warner was the sole occupant of the vehicle," the news release said. Warner agreed to allow police to take the vehicle, a maroon 1984 Buick Century, into custody for processing for evidence.

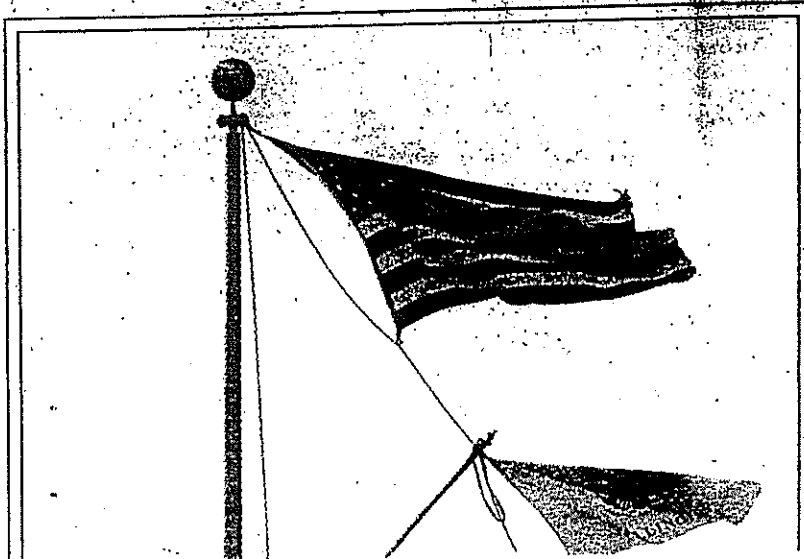

EIU committee plans campus renovation

■ University to expand Doudna Fine Arts Center, construct and improve campus buildings

CHARLESTON — The rehabilitation and expansion of Eastern Illinois University's Doudna Fine Arts Center, the rehabilitation of major academic buildings and the construction of several new buildings were among the proposals unveiled Tuesday at a

Plan to bring many changes to campus

CHARLESTON — Several potential projects were outlined in the Eastern Illinois University draft campus master plan Tuesday.

The plan recognizes the city of Charleston's desire for another east-west connector road south of Lincoln Avenue and proposes a route for the city to develop in the future. This route includes

ROBERT Questions

1 (R)	DO YOU KNOW ROBERT	YES
2 (R)	RECALL THE AGENT	NO
3 (R)	WAS HONDA	NO
4 (R)	DO YOU REMEMBER RICK HOSTETTER	NO
5 (R)	RECALL THE MARCH	NO
6 (R)	DO YOU HAVE ANYTHING TO SAY IN THE EXHIBIT	NO
7 (R)	RECALL THE MARCH	NO
8 (R)	DO YOU REMEMBER THE	NO
9 (R)	DO YOU REMEMBER THE	NO
10 (R)	DO YOU REMEMBER THE	NO

BEAR NEXT

ROBERT WARNER II

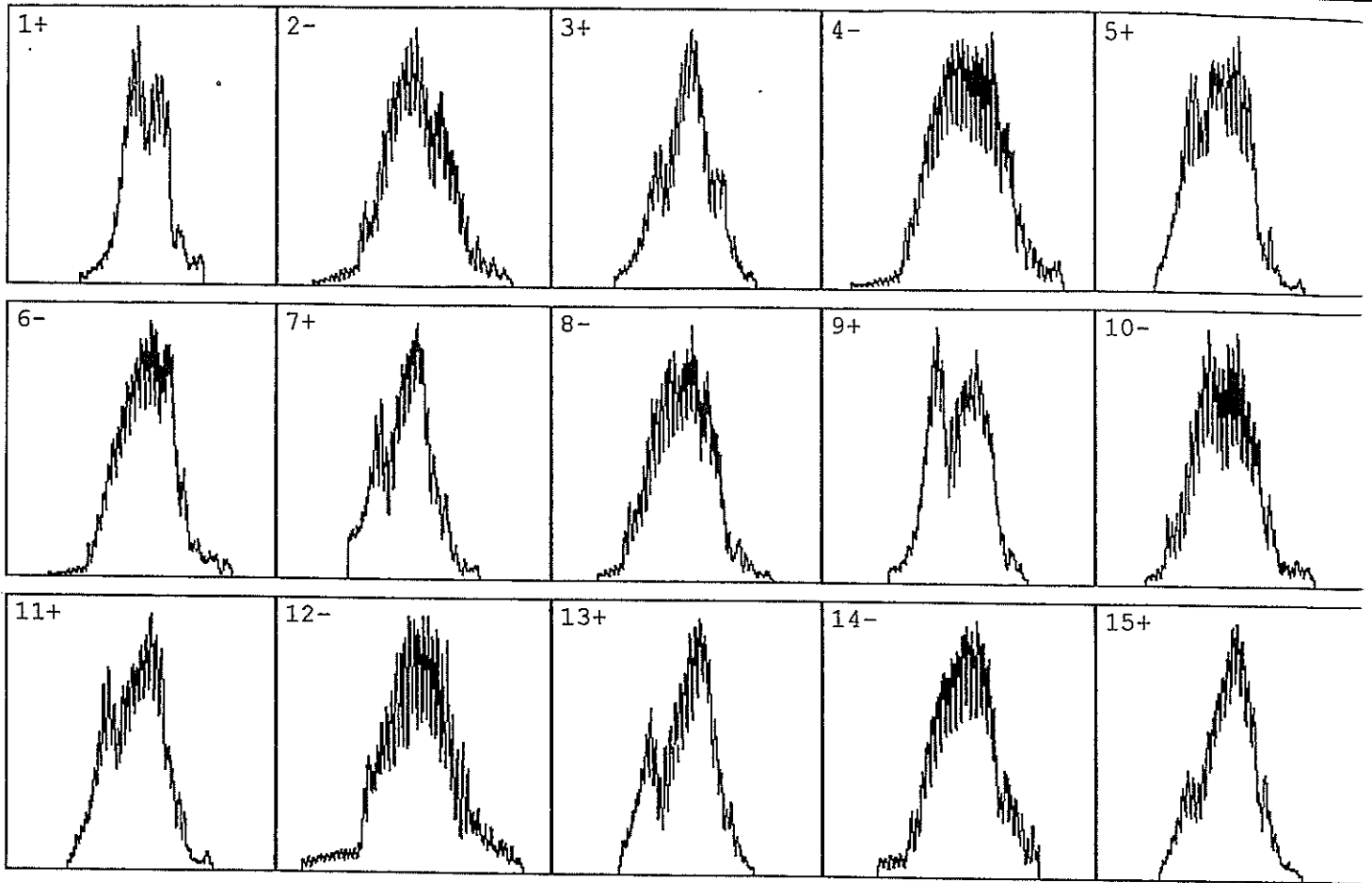

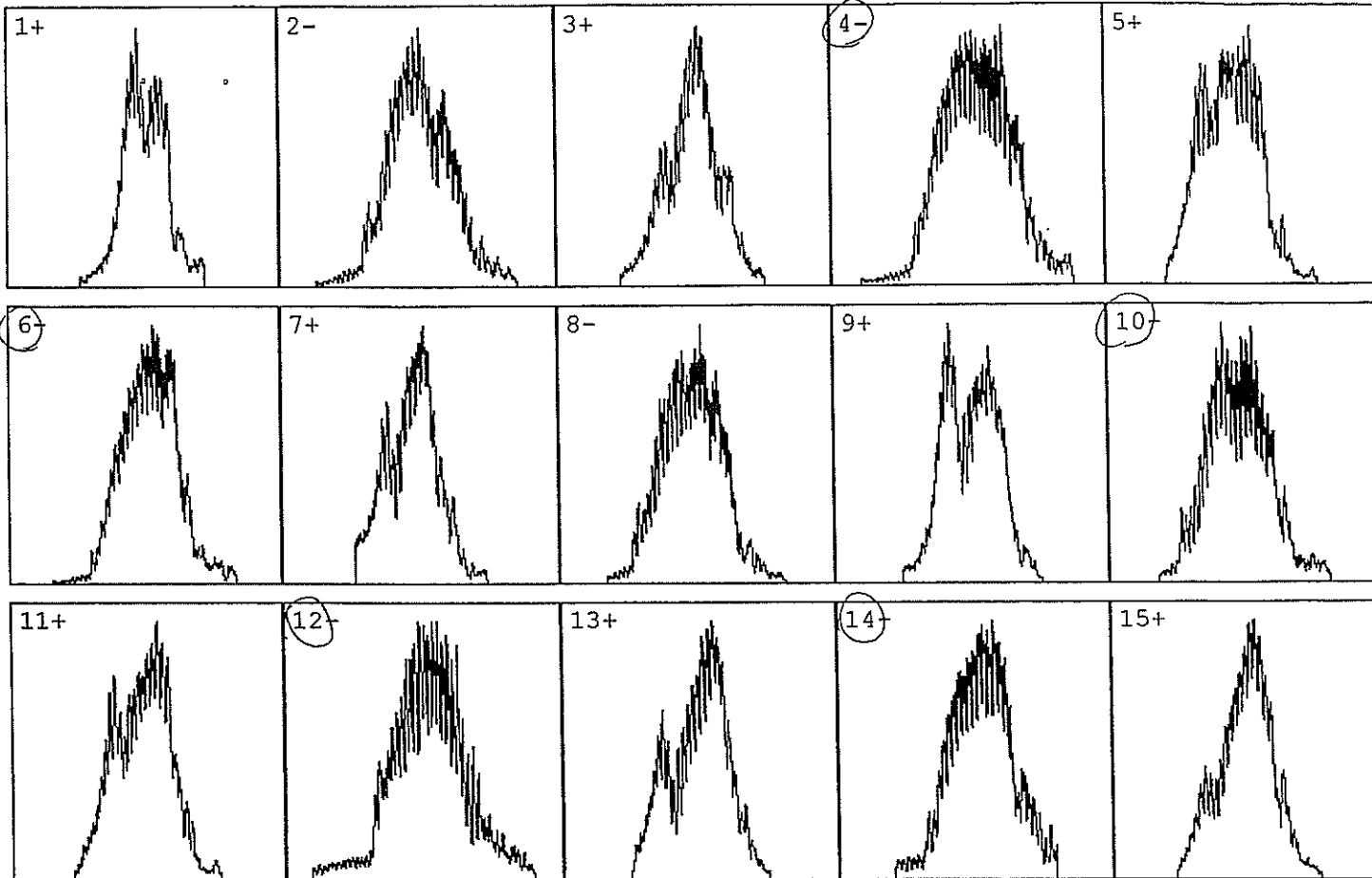

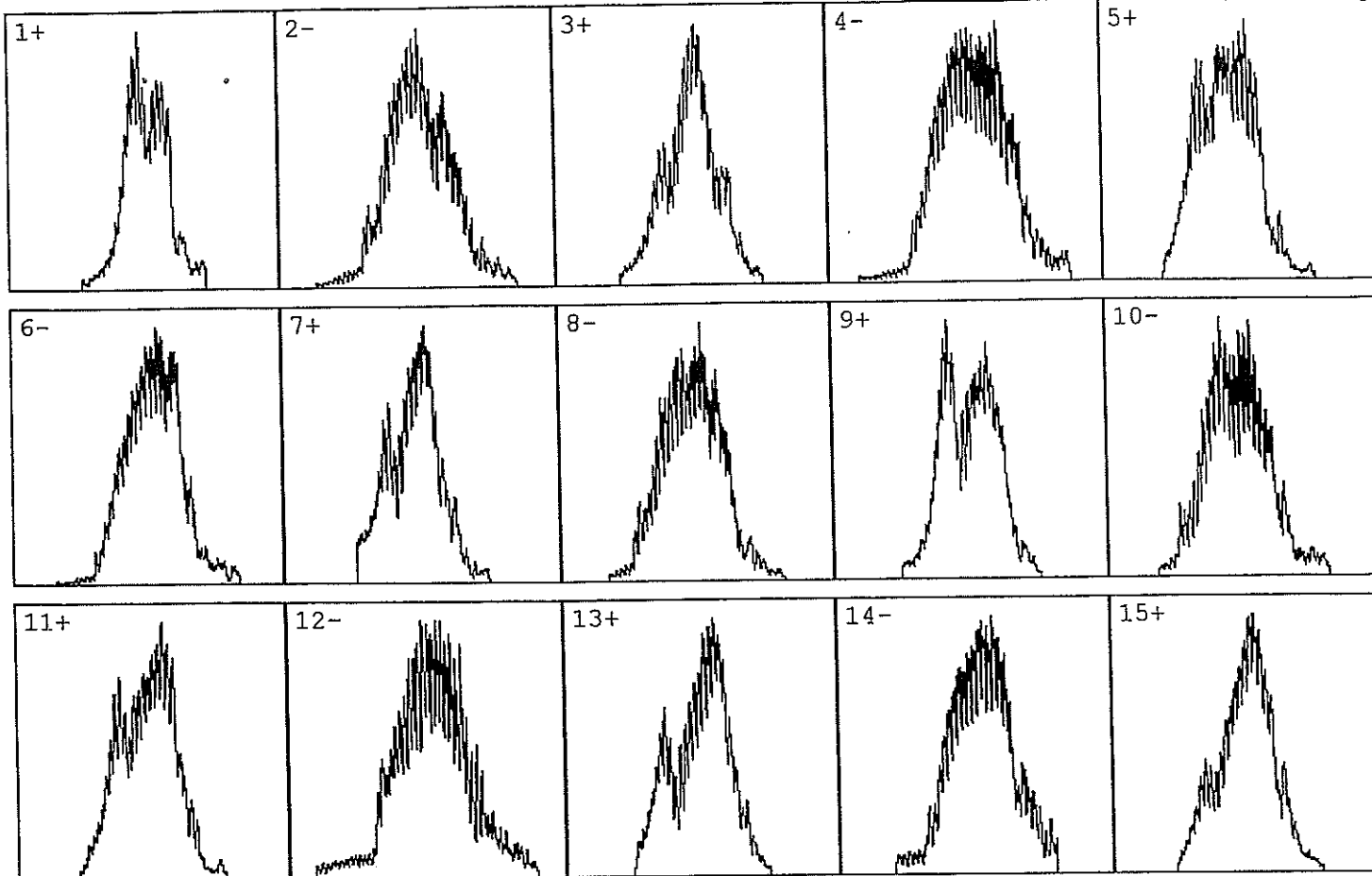

Questions

Q101	DO YOU HAVE ANYTHING TO DO WITH THE DEATH OF MARTIN LUTHER KING JR?	YES
Q102	ARE YOU GOING TO GO TO THE COURT?	YES
Q103	HAVE YOU EVER BEEN TO THE COURT?	YES
Q104	DO YOU KNOW ANYONE?	YES
Q105	DO YOU KNOW ANYONE WHO IS KILLING DR. MARTIN LUTHER KING JR?	YES
Q106	DO YOU KNOW ANYONE WHO IS KILLING DR. MARTIN LUTHER KING JR?	YES
Q107	DO YOU KNOW ANYONE WHO IS KILLING DR. MARTIN LUTHER KING JR?	YES
Q108	DO YOU KNOW ANYONE WHO IS KILLING DR. MARTIN LUTHER KING JR?	YES
Q109	DO YOU KNOW ANYONE WHO IS KILLING DR. MARTIN LUTHER KING JR?	YES
Q110	DO YOU KNOW ANYONE WHO IS KILLING DR. MARTIN LUTHER KING JR?	YES

Navigation buttons: Previous, Next, Home, End

System tray: Start, Stop, Run, Taskbar, System Clock, System Icons, System Tray

System Information: ROBERT WARNER H

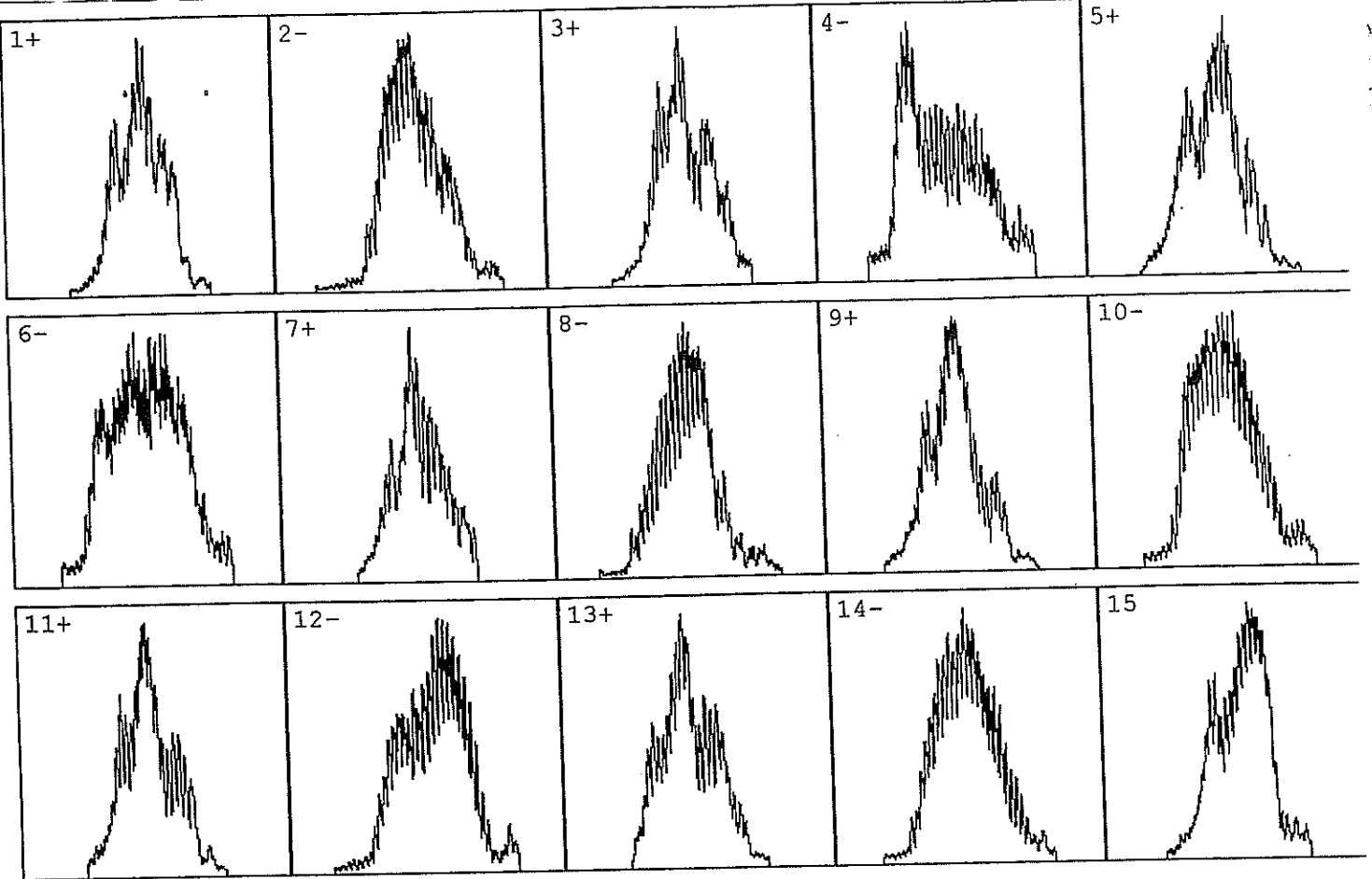

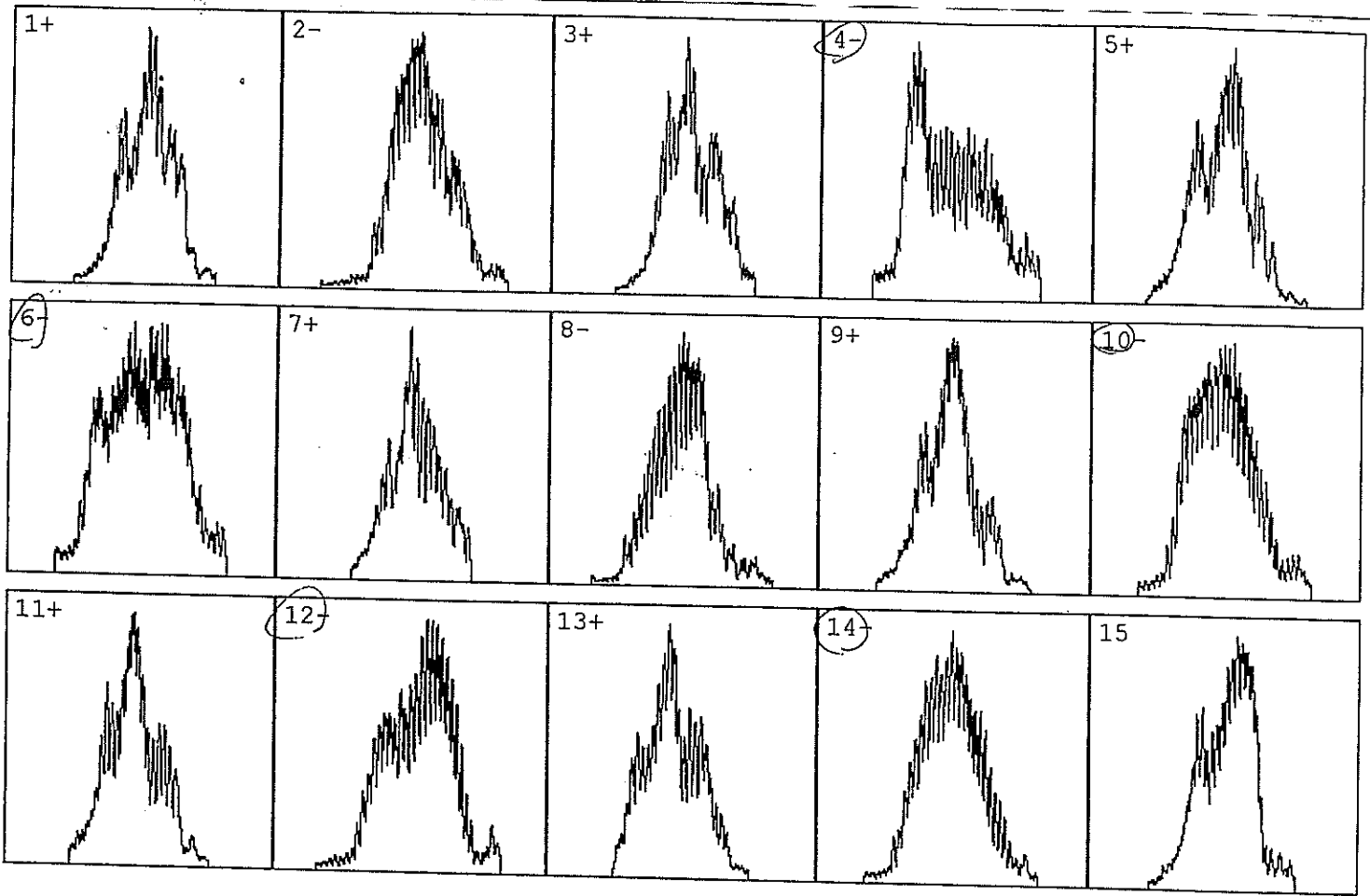

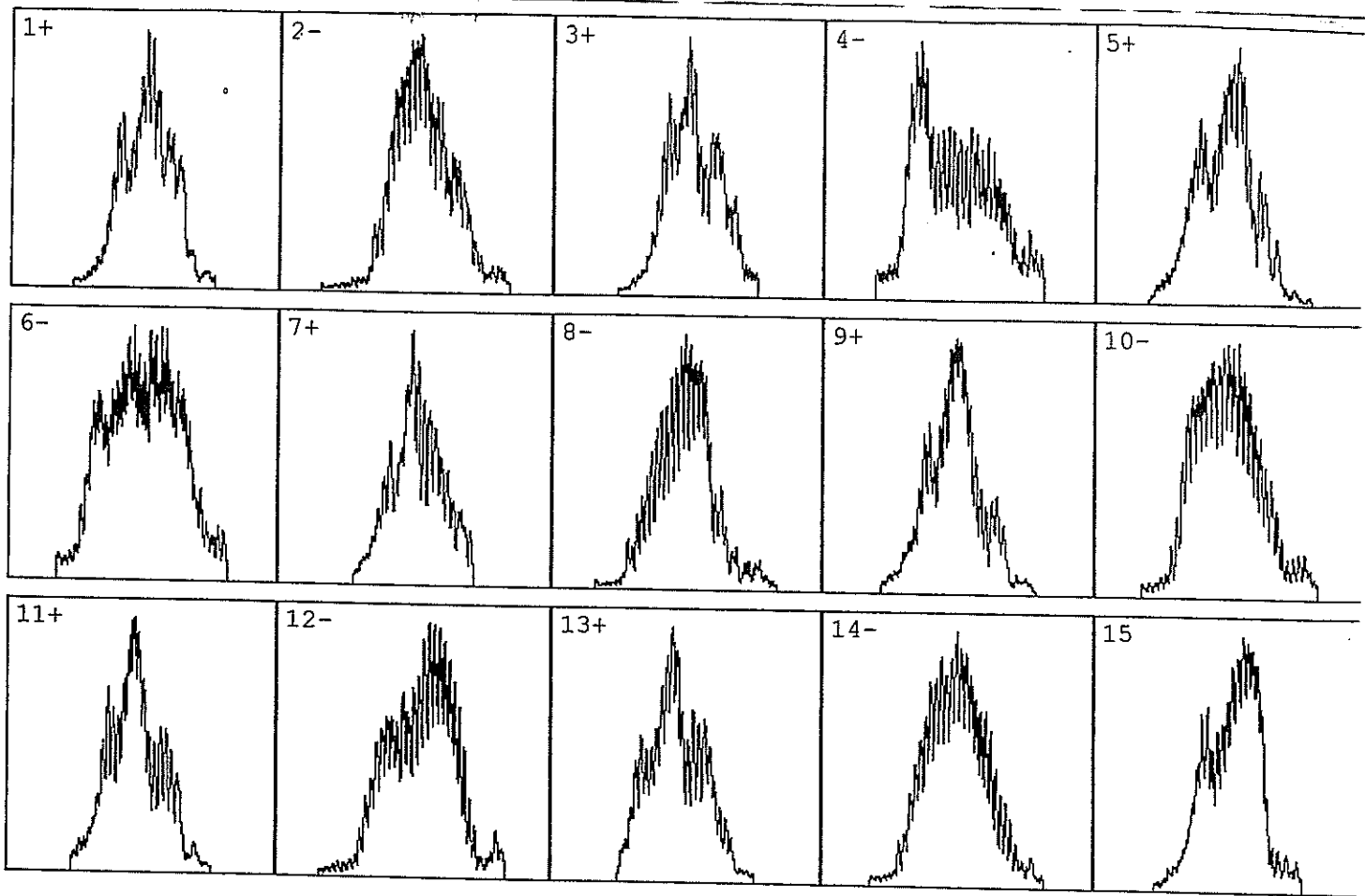



FBI FACSIMILE COVERSHEET

PRECEDENCE

- Immediate
- Priority
- Routine

CLASSIFICATION

- Top Secret
- Secret
- Confidential
- Sensitive
- Unclassified

Time Transmitted: 9 am
 Sender's Initials: MLS
 Number of Pages: 9
 (including coversheet)

To: _____
 Name of Office

Date: 3-4-99

Facsimile Number: _____

Attn: LT. MIKE BUSHMAN
 Name Room Telephone

From: _____
 Name of Office FBI Chicago

Subject: IL DL checks

Special Handling Instructions: _____

Originator's Name: _____ Telephone: _____

Originator's Facsimile Number: _____

Approved: _____

Brief Description of Communication Faxed: _____

facsimile
TRANSMITTAL

to: Lt. Mike Bushman
fax #: [REDACTED]
re: IL DL Checks
date: March 4, 1999
pages: 8, including this cover sheet

Mike,

Here are Illinois DMV printouts for John, Heith, and Jennifer Warner. Only John came back with a vehicle registration in Illinois - a 1984 Buick 4-door. The towns of Lerna, Mattoon, and Toledo are all located pretty close to one another, down in the Coles County / Cumberland County area. I still have an outstanding request for all vehicles registered at the Mattoon address. Will let you know. Thanks...

From the desk of...

SSA [REDACTED]

[REDACTED]-1, Chicago Division

FBI

[REDACTED]



Truth Verification Release Form

I, ROBERT D. WARNER, do hereby voluntarily, without duress, coercion, promise, reward or immunity, submit to examination by the polygraph or voice stress analysis truth verification technique, do hereby release, absolve and forever hold harmless, the NITV and PAUL HERRMANN, it's servants, agents, and anyone acting in it's behalf, from any and all claims, demands, or other damages from any matter, act, or thing arising out of aforesaid examination. I understand that this examination may be video taped and I release into the possession of the NITV all materials, recordings, and all other documents for the purpose of testimony and/or training.

Robert D. Warner
Signature

03/15/99
Date

Witnessed:

[Signature]

DI

ADDS

NDI

NO ADDS

The
City
of
West Palm Beach



"The Orchid City"

POLICE DEPARTMENT
P. O. Box [REDACTED]
West Palm Beach, Florida 33402
Tel: [REDACTED]

DATE: _____

I, _____ do hereby submit to a Voice Stress analyzer, having said technique explained to my satisfaction and hereby release the West Palm Beach Police Department and the interviewer and examiner administering this examination from all claims resulting from, or arising out of, this examination and do further authorize the release of the said examination and the information obtained to those parties having an interest in same. I further understand that I am not taking this examination as the sole condition of employment or of continued employment, and that I was advised that I could not be forced to take this examination by anyone. To the best of my knowledge, at this time, I have no physical or mental conditions which would prevent me from taking this examination.

Person being examined

Examiner administering examination

The examination now being over, I certify that I was well treated and remained of my own free will, having been advised that I could leave at any time. I was not asked any questions that were not discussed with me.

Person being examined

Examiner administering examination

1. CAS NO. **S99 01617** 2. CLASSIFICATION **630.11** 3. CENSUS **7,000.0**

4. INCIDENT **CS/S99**

5. INCIDENT LOCATION **NEW LONDON**

6. NAME LAST FIRST MI **[REDACTED]** 7. D.O.B. **[REDACTED]**

8. ADDRESS **[REDACTED]** 9. TX-HOME **[REDACTED]**

11. CITY **[REDACTED]** STATE **[REDACTED]** ZIP **[REDACTED]** 10. TX-BUSINESS **[REDACTED]**

12. DETAILS
**CALLER SAW A GRAYISH-BLUE CHEV
 VAN 2 DAYS AGO IN AM ON
 HWY 45 IN NEWLONDON. VAN HAD
 DAMAGE TO PASS SIDE OF BUMPER &**

2-24-99 2120

14. REC'D	15. DISP	16. 10-23	17. 10-24

13. DAY
 SUN 1 THU 5
 MON 2 FRI 6
 TUE 3 SAT 7
 WED 4

**MANITOWOC COUNTY SHERIFF
 INCIDENT CARD**

18. ASSIGNED **MTSO** **9129**

19. REC. BY **932** 20. DIS. BY **932**

21. HOW REC'D.
 1. 911
 2. POLICE RADIO
 3. PHONE
 4. TTY
 5. IN PERSON
 6. ON VIEW
 7. OFF. OFF DUTY
 8. C.B. RADIO
 9. OTHER

22. TYPE OF REPORT
 1. INCIDENT
 2. ACCIDENT
 3. CITATION
 4. NONE

23. STATUS
 1. UNFOUNDED
 2. PNL
 3. OTHER
 4. CLEARED
 5. EXCEPT CLEARED

24. DATE CLEARED **10/12/99**

25. OFFENSE TYPE
 1. ADULT NA
 2. JUVENILE
 3. UNKNOWN

21A. M.O. **[REDACTED]**

LEWIS

39. (CODE S-SUSPECT W-WITNESS V-VICTIM O-OTHER)

CODE	40. NAME-LAST	FIRST	MI	41. D.O.B.	42. ADDRESS	43. TELEPHONE

grill in a round shape as though it may have hit a tree or something of that general shape. Dispatch contacted New London PD via phone to request they BOLO for that van. due to TIME system being down. 932/mh

04/16/99 Vehicle not located, Close Out. M.J. Bushman

45. IF COMPLAINANT DIFFERENT THEN CALLER, ENTER NAME, ADDRESS, D.O.B., TELEPHONE.

46. IF CODE O (OTHER) IS USED IN FIELD #39, EXPLAIN.

INCIDENT REPORT: NOTE: IF SECTION 22 ABOVE HAS NUMBER 4 CHECKED, DO NOT GO BEYOND THIS LINE WITHOUT RECORDS SECTION BEING ADVISED, OR NO RECORD ENTRIES WILL BE MADE BELOW THIS LINE.

PROPERTY VALUE	26. PROPERTY	A. CURRENCY	B. JEWELRY	C. FURS CLOTHING	D. VEHICLE (LOCAL)	E. OFFICE EQUIPMENT	F. RADIO, TV CAMERAS	G. FIREARMS	H. HOUSE-HOLD GOODS
	STOLEN	\$	\$	\$	\$	\$	\$	\$	\$
	RECOVERED	\$	\$	\$	\$	\$	\$	\$	\$
	26. PROPERTY	I. CONSUMABLES	J. LIVESTOCK	K. DRUGS	L. MARINE ITEMS	M. CONSTRUCTION ITEMS	N. LAWN AND GARDEN	O. SPORTING GOODS	P. MISC BICYCLE
STOLEN	\$	\$	\$	\$	\$	\$	\$	\$	
RECOVERED	\$	\$	\$	\$	\$	\$	\$	\$	

27. PROPERTY RECOVERED: LOCALLY _____ OTHER JURISDICTION _____ (INSERT O OR L)

PROPERTY ITEMIZATION	PROPERTY STOLEN/RECOVERED ITEMIZATION, USE THE FOLLOWING FORMAT				
	28. QUANTITY	29. ARTICLE NAME	30. BRAND NAME	31. SERIAL NUMBER	32. CODE
					S R <input type="checkbox"/> <input type="checkbox"/>
					S R <input type="checkbox"/> <input type="checkbox"/>
					S R <input type="checkbox"/> <input type="checkbox"/>
					S R <input type="checkbox"/> <input type="checkbox"/>

33. PROPERTY DAMAGE AMOUNT \$ _____ 34. INSURANCE COMPANY _____

35. OFFICER ASSAULTED Y N 36. ARSON Y N 37. STRUCTURE CODE _____ 38. DAMAGE \$ _____

47. CIB ENTERED CANCELLED
 NCIC
 OTHER BROADCAST

48. TOTAL AMOUNT PROPERTY STOLEN \$ _____
 49. TOTAL AMOUNT PROPERTY RECOVERED \$ _____

50. IS REPORT CONTINUED? YES NO

51. CAUTION INDICATORS ATLS ETC

52. DATA PROCESS INFORMATION:

COMPUTER ENTERED DATE 4/22/98
 MICROFILM INDEXED INITIAL KS
 IS CASE CLASSIFICATION CORRECT? N
 IF N HAS CORRECTION BEEN MADE? N

53. FILE APPROVAL
 BY [Signature] DATE 04/20/98

1. CASE # S99 No 02982		2. CLASSIFICATION 5.71151		3. CENSUS 521000	
4. INCIDENT check veh s99-00242					
5. INCIDENT LOCATION 8th & Buffalo					
6. NAME - LAST - FIRST - MI MTPD				7. D.O.B. (3)	
8. ADDRESS				9. TX-HOME	
11. CITY			STATE	ZIP	10. TX-BUSINESS
12. DETAILS Pass. veh. from hit & run fatal					
14. REC'D	15. DISP	16. 10-23	17. 10-24	13. DAY SUN 1 THU MON 2 FRI 6 TUE 3 SAT 7 WED 4	
19. REC. BY 944		20. DIS. BY 944		22. TYPE OF REPORT <input checked="" type="checkbox"/> INCIDENT <input type="checkbox"/> ACCIDENT <input type="checkbox"/> CITATION <input type="checkbox"/> NONE	
21. HOW REC'D. 1. 911 2. POLICE RADIO <input checked="" type="checkbox"/> PHONE 3. TTY 4. IN PERSON 5. ON VIEW 6. OFF. OFF DUTY 7. C.B. RADIO 8. OTHER		23. STATUS 1. UNFOUNDED 2. PNL <input checked="" type="checkbox"/> OTHER 3. CLEARED 4. EXCEPT CLEARED		ACTIVE	
21A. M.O.		24. DATE CLEARED 10/20/99			
25. OFFENSE TYPE 1. ADULT <input type="checkbox"/> NA <input type="checkbox"/> 2. JUVENILE <input type="checkbox"/> 3. UNKNOWN <input type="checkbox"/>					

39. (CODE S-SUSPECT W-WITNESS V-VICTIM O-OTHER)						
CODE	40. NAME-LAST	FIRST	MI	41. D.O.B.	42. ADDRESS	43. TELEPHONE
	0	Muck	3113	Quane	E.	[REDACTED]
					Clark St, Manitowoc	

04-15-99: I, Deputy JJ Froelich, was dispatched to N. 8th St. at Buffalo reference checking a vehicle for the hit and run fatality. Officer Vorpahl from MTPD did locate the vehicle parked on N. 8th St. with some damage to the front end. Upon running the Wis. truck plate #AB70457, it was noted that the registration came back on a 1983 Chevy truck. The vin # was also verified. Damage on the vehicle did consist of damage to the front right grill. Also the front windshield was cracked. There was no damage noted on the hood or front bumper.

Information was passed on to Deputy Glaeser who later checked and found no match. JJFroelich/ps

45. IF COMPLAINANT DIFFERENT THEN CALLER, ENTER NAME, ADDRESS, D.O.B., TELEPHONE.

46. IF CODE O (OTHER) IS USED IN FIELD #39, EXPLAIN.

INCIDENT REPORT: NOTE: IF SECTION 22 ABOVE HAS NUMBER 4 CHECKED, DO NOT GO BEYOND THIS LINE WITHOUT RECORDS SECTION BEING ADVISED, OR NO RECORD ENTRIES WILL BE MADE BELOW THIS LINE.

PROPERTY VALUE	26. PROPERTY	A. CURRENCY	B. JEWELRY	C. FURS CLOTHING	D. VEHICLE (LOCAL)	E. OFFICE EQUIPMENT	F. RADIO, TV CAMERAS	G. FIREARMS	H. HOUSE-HOLD GOODS
	STOLEN	\$	\$	\$	\$	\$	\$	\$	\$
	RECOVERED	\$	\$	\$	\$	\$	\$	\$	\$
	26. PROPERTY	I. CONSUMABLES	J. LIVESTOCK	K. DRUGS	L. MARINE ITEMS	M. CONSTRUCTION ITEMS	N. LAWN AND GARDEN	O. SPORTING GOODS	P. MISC BICYCLE
STOLEN	\$	\$	\$	\$	\$	\$	\$	\$	
RECOVERED	\$	\$	\$	\$	\$	\$	\$	\$	

27. PROPERTY RECOVERED: LOCALLY _____ OTHER JURISDICTION _____ (INSERT O OR L)

PROPERTY ITEMIZATION	PROPERTY STOLEN/RECOVERED ITEMIZATION, USE THE FOLLOWING FORMAT				
	28. QUANTITY	29. ARTICLE NAME	30. BRAND NAME	31. SERIAL NUMBER	32. CODE
					S R <input type="checkbox"/> <input type="checkbox"/>
					S R <input type="checkbox"/> <input type="checkbox"/>
					S R <input type="checkbox"/> <input type="checkbox"/>
					S R <input type="checkbox"/> <input type="checkbox"/>

33. PROPERTY DAMAGE AMOUNT \$ _____ 34. INSURANCE COMPANY _____

35. OFFICER ASSAULTED Y N 36. ARSON Y N 37. STRUCTURE CODE _____ 38. DAMAGE \$ _____

47. CIB	ENTERED <input type="checkbox"/>	CANCELLED <input type="checkbox"/>	48. TOTAL AMOUNT PROPERTY STOLEN \$ _____
NCIC	<input type="checkbox"/>	<input type="checkbox"/>	
OTHER BROADCAST	<input type="checkbox"/>	<input type="checkbox"/>	
			49. TOTAL AMOUNT PROPERTY RECOVERED \$ _____

50. IS REPORT CONTINUED? YES NO 51. CAUTION INDICATORS, ATLS ETC.

52. DATA PROCESS INFORMATION:

COMPUTER ENTERED DATE 4/20/99

MICROFILM INDEXED INITIAL KS

IS CASE CLASSIFICATION CORRECT? Y N

IF N HAS CORRECTION BEEN MADE? Y N

53. FILE APPROVAL BY [Signature] DATE 04/20/99

1. CASE # S99 No 03012 | 2. CLASSIFICATION 6,310,11 | 3. CENSUS 5,210,0,0

4. INCIDENT CS / See 599-00242

5. INCIDENT LOCATION MTWC

6. NAME - LAST - FIRST - MI ANONYMOUS (2) | 7. D.O.B.

8. ADDRESS | 9. TX-HOME

11. CITY STATE ZIP | 10. TX-BUSINESS

12. DETAILS
 COMPL. REPORTS FULL SZ CHEV VAN
 RP BK62211 HAS RE-DONE,
 RE-PAINTED GRILL. (SEE ATTACHED)

1019 04-16-99 1130

MANITOWOC COUNTY SHERIFF INCIDENT CARD

18. ASSIGNED MTSO 929

COLBORN 4312

19. REC. BY 930 | 20. DIS. BY 930

22. TYPE OF REPORT
 1. INCIDENT
 2. ACCIDENT
 3. CITATION
 4. NONE

21. HOW REC'D.
 1. 911
 2. POLICE RADIO
 3. PHONE
 4. TTY
 5. IN PERSON
 6. ON VIEW
 7. OFF. OFF DUTY
 8. C.B. RADIO
 9. OTHER

23. STATUS
 1. UNFOUNDED
 2. PNL
 3. OTHER
 4. CLEARED
 5. EXCEPT CLEARED

24. DATE CLEARED 04/28/99
 25. OFFENSE TYPE
 1. ADULT
 2. JUVENILE
 3. UNKNOWN

13. DAY
 SUN 1 THU 5
 MON 2 FR 6
 TUE 3 SAT 7
 WED 4

FBI

39. (CODE S-SUSPECT W-WITNESS V-VICTIM O-OTHER)

CODE	40. NAME - LAST	FIRST	MI	41. D.O.B.	42. ADDRESS	43. TELEPHONE
0	PELLOWS	JEFFREY	J.		W. MARSHALL ST.	

04/16/99 @ 1130 Hrs.: I, Deputy Colborn, was assigned this incident by MTSO Dispatch. Preliminary information was that an anonymous caller had observed a tan Chevrolet van bearing WI RP BK62211 somewhere in the City of Manitowoc. Apparently this vehicle had a repainted grill and the anonymous caller was curious as to whether this vehicle had been checked.

Using the FBI Quick Start Computer System I was able to ascertain that this vehicle had not yet been checked. I did respond to [redacted] W. Marshall St. in the City of Manitowoc where I made contact with the vehicle owner's mother. The mother stated that the owner who she identified as her son, JEFFREY, was currently at his place of employment, FISHER HAMILTON CO., in the City of Two Rivers.

I did respond to FISHER HAMILTON on Columbus St. in the City of Two Rivers where I located this vehicle in the employee parking lot. I did check the vehicle and found the grill to have been repainted quite recently. I did find the grill to be whole and intact missing only the Chevrolet emblem from the front of the grill. No other pieces of the grill were damaged. I also did not observe any front fender, hood, windshield, or any other sheet metal or structural damage to the vehicle.

Based on these observations, at this time it does not appear that this vehicle would be the suspect vehicle in the fatal hit and run.

No further action taken at this time. A copy of this incident is to be forwarded to Lt. Bushman for his review as well as to Deputy Raube for entry into the FBI Rapid Start Computer Program. AColborn /paf

MTA

04/28/99 0550 Hrs this info added to computer program by 417. EUG *ETG*

S99 03012

45. IF COMPLAINANT DIFFERENT THEN CALLER, ENTER NAME, ADDRESS, D.O.B., TELEPHONE.

46. IF CODE O (OTHER) IS USED IN FIELD #39, EXPLAIN.

INCIDENT REPORT: NOTE: IF SECTION 22 ABOVE HAS NUMBER 4 CHECKED, DO NOT GO BEYOND THIS LINE WITHOUT RECORDS SECTION BEING ADVISED, OR NO RECORD ENTRIES WILL BE MADE BELOW THIS LINE.

PROPERTY VALUE	26. PROPERTY	A. CURRENCY	B. JEWELRY	C. FURS CLOTHING	D. VEHICLE (LOCAL)	E. OFFICE EQUIPMENT	F. RADIO, TV CAMERAS	G. FIREARMS	H. HOUSE-HOLD GOODS
	STOLEN	\$	\$	\$	\$	\$	\$	\$	\$
	RECOVERED	\$	\$	\$	\$	\$	\$	\$	\$
	26. PROPERTY	I. CONSUM-ABLES	J. LIVESTOCK	K. DRUGS	L. MARINE ITEMS	M. CONSTRUCTION ITEMS	N. LAWN AND GARDEN	O. SPORTING GOODS	P. MISC BICYCLE
	STOLEN	\$	\$	\$	\$	\$	\$	\$	\$
	RECOVERED	\$	\$	\$	\$	\$	\$	\$	\$

27. PROPERTY RECOVERED: LOCALLY _____ OTHER JURISDICTION _____ (INSERT O OR L)

PROPERTY ITEMIZATION	PROPERTY STOLEN/RECOVERED ITEMIZATION, USE THE FOLLOWING FORMAT				
	28. QUANTITY	29. ARTICLE NAME	30. BRAND NAME	31. SERIAL NUMBER	32. CODE
					S R <input type="checkbox"/> <input type="checkbox"/>
					S R <input type="checkbox"/> <input type="checkbox"/>
					S R <input type="checkbox"/> <input type="checkbox"/>
					S R <input type="checkbox"/> <input type="checkbox"/>
					S R <input type="checkbox"/> <input type="checkbox"/>

33. PROPERTY DAMAGE AMOUNT \$ _____ 34. INSURANCE COMPANY _____

35. OFFICER ASSAULTED Y N 36. ARSON Y N 37. STRUCTURE CODE _____ 38. DAMAGE \$ _____

47. CIB	ENTERED <input type="checkbox"/>	CANCELLED <input type="checkbox"/>	48. TOTAL AMOUNT PROPERTY STOLEN \$ _____
NCIC	<input type="checkbox"/>	<input type="checkbox"/>	
OTHER BROADCAST	<input type="checkbox"/>	<input type="checkbox"/>	
			49. TOTAL AMOUNT PROPERTY RECOVERED \$ _____

50. IS REPORT CONTINUED? YES NO 51. CAUTION INDICATORS, ATLS ETC.

52. DATA PROCESS INFORMATION:

COMPUTER ENTERED DATE 16 09 99

MICROFILM INDEXED INITIAL AS

IS CASE CLASSIFICATION CORRECT? IF N HAS CORRECTION BEEN MADE? Y N N

53. FILE APPROVAL

BY [Signature] DATE 04 28 99

1. CASE # S99 No 02948 2. CLASSIFICATION 63011 3. CENSUS 701000

4. INCIDENT CS/59900242
 5. INCIDENT LOCATION Plymouth
 6. NAME - LAST - FIRST - MI Anonymous 7. D.O.B.
 8. ADDRESS 9. TX-HOME
 11. CITY STATE ZIP 10. TX-BUSINESS

041499 1340

MANITOWOC COUNTY SHERIFF
INCIDENT CARD

18. ASSIGNED CS MTS

19. REC. BY 923 20. DIS. BY 923

21. HOW REC'D.
 1. 911
 2. POLICE RADIO
 3. PHONE
 4. TTY
 5. IN PERSON
 6. ON VIEW
 7. OFF. OFF DUTY
 8. C.B. RADIO
 9. OTHER

22. TYPE OF REPORT
 1. INCIDENT
 2. ACCIDENT
 3. CITATION
 4. NONE

23. STATUS
 1. UNFOUNDED
 2. PNL
 3. OTHER
 4. CLEARED
 5. EXCEPT CLEARED

24. DATE CLEARED 042099

25. OFFENSE TYPE
 1. ADULT NA
 2. JUVENILE
 3. UNKNOWN

12. DETAILS
 Reports seeing veh. at Great Lakes Cheese in Plymouth w/ front end damage to grill. See worksheet attached.

39. (CODE S-SUSPECT W-WITNESS V-VICTIM O-OTHER)						
CODE	40. NAME-LAST	FIRST	MI	41. D.O.B.	42. ADDRESS	43. TELEPHONE
O	Krupka,	John M			W. Hawes Ave, Applton	

04/16/99 2130 hrs Contact made at the registered owners residence and he was not at home. Female party did not ask who was calling and answered all questions relating to the type of damage and where it occurred. Apparently Krupka struck two deer on his way home from work while traveling through Calumet County.
 Contact made with Calumet, last entry for Krupka 1995.
 Check of in-house, Krupka involved in a Truck Vs. Deer 07-10-98 S98-05849, Close out.
 Copy of accident report attached. M.J. Bushman

45. IF COMPLAINANT DIFFERENT THEN CALLER, ENTER NAME, ADDRESS, D.O.B., TELEPHONE.

46. IF CODE O (OTHER) IS USED IN FIELD #39, EXPLAIN.

INCIDENT REPORT: NOTE: IF SECTION 22 ABOVE HAS NUMBER 4 CHECKED, DO NOT GO BEYOND THIS LINE WITHOUT RECORDS SECTION BEING ADVISED, OR NO RECORD ENTRIES WILL BE MADE BELOW THIS LINE.

PROPERTY VALUE	26. PROPERTY	A. CURRENCY	B. JEWELRY	C. FURS CLOTHING	D. VEHICLE (LOCAL)	E. OFFICE EQUIPMENT	F. RADIO, TV CAMERAS	G. FIREARMS	H. HOUSEHOLD GOODS
	STOLEN	\$	\$	\$	\$	\$	\$	\$	\$
	RECOVERED	\$	\$	\$	\$	\$	\$	\$	\$
	26. PROPERTY	I. CONSUMABLES	J. LIVESTOCK	K. DRUGS	L. MARINE ITEMS	M. CONSTRUCTION ITEMS	N. LAWN AND GARDEN	O. SPORTING GOODS	P. MISC BICYCLE
	STOLEN	\$	\$	\$	\$	\$	\$	\$	\$
	RECOVERED	\$	\$	\$	\$	\$	\$	\$	\$

27. PROPERTY RECOVERED: LOCALLY _____ OTHER JURISDICTION _____ (INSERT O OR L)

PROPERTY ITEMIZATION	PROPERTY STOLEN/RECOVERED ITEMIZATION, USE THE FOLLOWING FORMAT				
	28. QUANTITY	29. ARTICLE NAME	30. BRAND NAME	31. SERIAL NUMBER	32. CODE
					S R <input type="checkbox"/> <input type="checkbox"/>
					S R <input type="checkbox"/> <input type="checkbox"/>
					S R <input type="checkbox"/> <input type="checkbox"/>
					S R <input type="checkbox"/> <input type="checkbox"/>

33. PROPERTY DAMAGE AMOUNT \$ _____ 34. INSURANCE COMPANY _____

35. OFFICER ASSAULTED Y N 36. ARSON Y N 37. STRUCTURE CODE _____ 38. DAMAGE \$ _____

47. CIB	ENTERED	CANCELLED	48. TOTAL AMOUNT PROPERTY STOLEN \$ _____
	<input type="checkbox"/>	<input type="checkbox"/>	
	NCIC	<input type="checkbox"/>	
OTHER BROADCAST	<input type="checkbox"/>	<input type="checkbox"/>	49. TOTAL AMOUNT PROPERTY RECOVERED \$ _____

50. IS REPORT CONTINUED? YES NO 51. CAUTION INDICATORS, ATLS ETC.

52. DATA PROCESS INFORMATION:

COMPUTER ENTERED DATE 6/29/99

MICROFILM INDEXED INITIAL KS

IS CASE CLASSIFICATION CORRECT? IF N HAS CORRECTION BEEN MADE? Y N

53. FILE APPROVAL

BY [Signature] DATE 07/20/99

INCIDENT #: 598-05849

CENSUS: 04029

General Information

WISCONSIN DRIVER REPORT OF ACCIDENT

04-16-0020-0810

Reportable Accident
 NO YES

Hit & Run Accident
 NO YES

ACCIDENT LOCATION MANITOWOC EATON

ACCIDENT DATE 07-10-98 FRI 12:20 AM PM

Total Units Involved 1 Total Injured 0

Name and Number of Street(s) or Highway or Parking Lot
STH 67 - 1 mi South CTH C

U N I T 1
 Driver Full Name (Last, First, MI) KRUPKA JOHN M 170182 Sex M
 Address [REDACTED] W. HAWES AV [REDACTED]
 City & State APPLETON WI 54914 Zip Code [REDACTED] Phone Number [REDACTED]
 Driver License Number [REDACTED] Issuing State WI
 Vehicle Legally Parked YES NO
 Hit a Deer YES NO
 Operating a commercial vehicle? NO YES - A B C
 If yes, circle appropriate classification

Owner Full Name (Last, First, MI) S/A
 Address _____
 City & State _____ Zip Code _____ Phone Number (____) _____
 License Plate Number AL25576 Exp Yr 98 Issuing State WI Vehicle Make CHEV Year 83 Color GRY
 Vehicle Identification Number [REDACTED]
 Was a motor vehicle liability insurance policy in effect on the day of the accident?
 NO YES Policy Holder's Name S/A
 Exact Name of Insurance Company STATE FARM

U N I T 2
 Driver Full Name (Last, First, MI) _____ Sex _____
 Address _____ Birth Date _____
 City & State _____ Zip Code _____ Phone Number (____) _____
 Driver License Number _____ Issuing State _____
 Vehicle Legally Parked YES NO
 Hit a Deer YES NO
 Operating a commercial vehicle? NO YES - A B C
 If yes, circle appropriate classification

Owner Full Name (Last, First, MI) _____
 Address _____
 City & State _____ Zip Code _____ Phone Number (____) _____
 License Plate Number _____ Exp Yr _____ Issuing State _____ Vehicle Make _____ Year _____ Color _____
 Vehicle Identification Number _____
 Was a motor vehicle liability insurance policy in effect on the day of the accident?
 NO YES Policy Holder's Name _____
 Exact Name of Insurance Company _____

INJURED (If driver, was person injured, write "Operator" instead of Name)		Address		City & State	Zip Code	Sex	Date of Birth	Injury Code
Unit No. <u>1</u>	Name (Last, First, MI) <u>[REDACTED]</u>	[REDACTED]		[REDACTED]	[REDACTED]	[REDACTED]	[REDACTED]	[REDACTED]
Unit No. _____	Name (Last, First, MI) _____	Address _____		City & State _____	Zip Code _____	Sex _____	Date of Birth _____	Injury Code _____

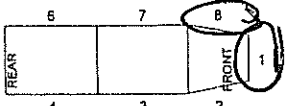
VEHICLE Unit 1 - (Circle numbered areas of vehicle damaged)
 DAMAGE Is damage over \$1000? Yes No
 If Yes, damage estimate \$ _____

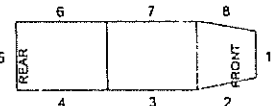
Unit 2 - (Circle numbered areas of vehicle damaged)
 Is damage over \$1000? No Yes
 If Yes, damage estimate \$ _____

PROPERTY DAMAGE Describe what was damaged (Do Not include vehicle damage)
 Property Owner Full Name (Last, First, MI) _____ Address, City, State & Zip Code _____ Phone Number (____) _____

NARRATIVE (Print a brief description of the accident):
VEH #1 NB ON STH 67
HIT A DEER

 Citation/s: NONE

DIAGRAM (Draw a basic picture of the accident and location. Indicate North by putting an arrow in the circle):

1. CASE # S99 No 02102 2. CLASSIFICATION 630.11 3. CENSUS 701000

4. INCIDENT CS / S99-00242

5. INCIDENT LOCATION Chilton CTH BB

6. NAME [REDACTED] 7. D.O.B. [REDACTED]

8. ADDRESS [REDACTED] 9. TX-HOME [REDACTED]

11. CITY STATE ZIP 10. TX-BUSINESS

12. DETAILS
 Chev. with grill broke out is in Chilton area. No RP obtained at this time. Unk driver.

031598 1145

MANITOWOC COUNTY SHERIFF INCIDENT CARD

18. ASSIGNED
 MTSO 929

19. REC. BY 923 20. DIS. BY 923

21. HOW REC'D.
 1. 911
 2. POLICE RADIO
 3. PHONE
 4. TTY
 5. IN PERSON
 6. ON VIEW
 7. OFF. OFF DUTY
 8. C.B. RADIO
 9. OTHER

22. TYPE OF REPORT
 1. INCIDENT
 2. ACCIDENT
 3. CITATION
 4. NONE

23. STATUS
 1. UNFOUNDED
 2. PNL
 3. OTHER
 4. CLEARED
 5. EXCEPT CLEARED

24. DATE CLEARED 04/27/99
 25. OFFENSE TYPE
 1. ADULT NA
 2. JUVENILE
 3. UNKNOWN

14. REC'D 15. DISP 16. 10-23 17. 10-24
 13. DAY
 SUN 1 THU 5
 MON 2 FRI 6
 TUE 3 SAT 7
 WED 4

39. (CODE S-SUSPECT W-WITNESS V-VICTIM O-OTHER)						
CODE	40. NAME-LAST	FIRST	MI	41. D.O.B.	42. ADDRESS	43. TELEPHONE

04/26/99 This complaint remained in the Crime Stoppers S99-00242 file until todays date and there was no plate number obtained from additional sightings. Unable to followup without registration. Close out. M.J. Bushman

45. IF COMPLAINANT DIFFERENT THEN CALLER, ENTER NAME, ADDRESS, D.O.B., TELEPHONE.

46. IF CODE O (OTHER) IS USED IN FIELD #39, EXPLAIN.

INCIDENT REPORT: NOTE: IF SECTION 22 ABOVE HAS NUMBER 4 CHECKED, DO NOT GO BEYOND THIS LINE WITHOUT RECORDS SECTION BEING ADVISED, OR NO RECORD ENTRIES WILL BE MADE BELOW THIS LINE.

PROPERTY VALUE	26. PROPERTY	A. CURRENCY	B. JEWELRY	C. FURS CLOTHING	D. VEHICLE (LOCAL)	E. OFFICE EQUIPMENT	F. RADIO, TV CAMERAS	G. FIREARMS	H. HOUSE-HOLD GOODS
	STOLEN	\$	\$	\$	\$	\$	\$	\$	\$
	RECOVERED	\$	\$	\$	\$	\$	\$	\$	\$
	26. PROPERTY	I. CONSUM-ABLES	J. LIVESTOCK	K. DRUGS	L. MARINE ITEMS	M. CONSTRUCTION ITEMS	N. LAWN AND GARDEN	O. SPORTING GOODS	P. MISC BICYCLE
	STOLEN	\$	\$	\$	\$	\$	\$	\$	\$
	RECOVERED	\$	\$	\$	\$	\$	\$	\$	\$

27. PROPERTY RECOVERED: LOCALLY _____ OTHER JURISDICTION _____ (INSERT O OR L)

PROPERTY ITEMIZATION	PROPERTY STOLEN/RECOVERED ITEMIZATION, USE THE FOLLOWING FORMAT				
	28. QUANTITY	29. ARTICLE NAME	30. BRAND NAME	31. SERIAL NUMBER	32. CODE
					S <input type="checkbox"/> R <input type="checkbox"/>
					S <input type="checkbox"/> R <input type="checkbox"/>
					S <input type="checkbox"/> R <input type="checkbox"/>
					S <input type="checkbox"/> R <input type="checkbox"/>
					S <input type="checkbox"/> R <input type="checkbox"/>

33. PROPERTY DAMAGE AMOUNT \$ _____

34. INSURANCE COMPANY _____

35. OFFICER ASSAULTED Y N

36. ARSON Y N

37. STRUCTURE CODE _____

38. DAMAGE \$ _____

47. CIB ENTERED CANCELLED
 NCIC
 OTHER BROADCAST

48. TOTAL AMOUNT PROPERTY STOLEN \$ _____

49. TOTAL AMOUNT PROPERTY RECOVERED \$ _____

50. IS REPORT CONTINUED? YES NO

51. CAUTION INDICATORS, ATLS ETC.

52. DATA PROCESS INFORMATION:

COMPUTER ENTERED DATE 11/29/99
 MICROFILM INDEXED INITIAL RS

53. FILE APPROVAL

IS CASE CLASSIFICATION CORRECT? IF N HAS CORRECTION BEEN MADE?
 Y N

BY [Signature] DATE 04/27/99

1. CASE # S99 No 02906 2. CLASSIFICATION 630.11 3. CENSUS 60900

4. INCIDENT CS/399-00242

5. INCIDENT LOCATION Mtac on Sheb Co. (RD. UNK)

6. NAME - LAST - FIRST - MI ANONY. 7. D.O.B.

8. ADDRESS 9. TX-HOME 10. TX-BUSINESS

11. CITY STATE ZIP

12. DETAILS
 Caller saw a dk colored
 Suburban about a week
 ago w/ front end damage.
 Reg # 83177T / WI. HP WAS
 on Mtac/Sheboygan

041399 1027

14. REC'D	15. DISP	16. 10-23	17. 10-24
13. DAY			
SUN 1	THU 5		
MON 2	FRI 6		
TUE 3	SAT 7		
WED 4			

MANITOWOC COUNTY SHERIFF
INCIDENT CARD

18. ASSIGNED MTSE 9219

19. REC. BY 920 20. DIS. BY

21. HOW REC'D.
 1. 911
 2. POLICE RADIO
 3. PHONE
 4. TTY
 5. IN PERSON
 6. ON VIEW
 7. OFF. OFF DUTY
 8. C.B. RADIO
 9. OTHER
 21A. M.O.

22. TYPE OF REPORT
 1. INCIDENT
 2. ACCIDENT
 3. CITATION
 4. NONE

23. STATUS
 1. UNFOUNDED
 2. PNL
 3. OTHER
 4. CLEARED
 5. EXCEPT CLEARED

24. DATE CLEARED 04/20/99

25. OFFENSE TYPE
 1. ADULT NA
 2. JUVENILE
 3. UNKNOWN

39. (CODE S-SUSPECT W-WITNESS V-VICTIM O-OTHER)						
CODE	40. NAME-LAST	FIRST	MI	41. D.O.B.	42. ADDRESS	43. TELEPHONE

04/16/99 2220hrs Contact made with DI Tisler working Reedsville patrol and request made to check on the Sellers vehicle. He stated he saw a similar complaint sometime back and it has already been checked and is not a match. Close out. M.J. Bushman

1. CASE # S99 No 02912 | 2. CLASSIFICATION b3011 | 3. CENSUS 7.0000

4. INCIDENT CS/599-00242

5. INCIDENT LOCATION MARIBEL AREA

6. NAME - LAST, FIRST, MI [REDACTED] | 7. D.O.B. [REDACTED]

8. ADDRESS [REDACTED]

11. CITY [REDACTED] | 10. TX-BUSINESS [REDACTED]

12. DETAILS REPORTS SEEING A DAMAGED VEH

THOUGHT TO BE OWNED BY PACKERLAND

INDUSTRIAL. RECENTLY SAW SIM VEH

W/PLATE BH78002/TX/WI

4-13-99 1300

14. REC'D	15. DISP	16. 10-23	17. 10-24
13. DAY			
SUN 1	THU 5		
MON 2	FRI 6		
TUE 3	SAT 7		
WED 4			

MANITOWOC COUNTY SHERIFF INCIDENT CARD			
18. ASSIGNED		LT THORRINGTON 436	
		MISO 989	
19. REC. BY	20. DIS. BY	22. TYPE OF REPORT	
926	436	① INCIDENT	
21. HOW REC'D.		2. ACCIDENT	
1. 911		3. CITATION	
2. POLICE RADIO		4. NONE	
3. PHONE		23. STATUS	
4. TTY		1. UNFOUNDED	
⑤ IN PERSON		2. PNL	
6. ON VIEW		③ OTHER	
7. OFF. OFF DUTY		4. CLEARED	
8. C.B. RADIO		5. EXCEPT CLEARED	
9. OTHER		24. DATE CLEARED 05/16/05	
21A. M.O.		25. OFFENSE TYPE	
		1. ADULT <input type="checkbox"/> NA <input checked="" type="checkbox"/>	
		2. JUVENILE <input type="checkbox"/>	
		3. UNKNOWN <input type="checkbox"/>	

39. (CODE S-SUSPECT W-WITNESS V-VICTIM O-OTHER)						
CODE	40. NAME-LAST	FIRST	MI	41. D.O.B.	42. ADDRESS	43. TELEPHONE
	PACKER CITY INTL TRUCKS INC				MANSON RD GRAN BAY, WI	

04-13-99 1430 I, Lt. Thorrington called Packer City Intl inquiring to speak to the sales manager. He was busy at the moment, I continued speaking to the receptionist. Upon reading the information that D.I. Tisler gave me, (see attached) it was pointed out to me that Packerland Industrial and Packer City Intl are not associated nor are they the same business. Since the plate comes back to Packer City Intl. I requested the sales manager to call when it was convenient for him. I was also informed they have 3 divisions being leasing, service, and sales. The original caller indicated the first vehicle he had seen was a van with damage to the drivers door. The second sighting was a white dodge with plate BH78002.

Shortly after my first call I received a call back from the Sales Manager. He indicated that they are the International Truck dealer although many of their parts vehicles are dodge vans. Almost all are less than 5 years old and are the same color flat silver. After speaking with him it would appear that this company would not have any such vehicle previously described as a suspect vehicle. The sales manager looked through the Green Bay phone book for Packerland Industrial and could find no such listing in the Green Bay area.

Lt. Thorrington *at T*

S99 No 02912

45. IF COMPLAINANT DIFFERENT THEN CALLER, ENTER NAME, ADDRESS, D.O.B., TELEPHONE.

46. IF CODE O (OTHER) IS USED IN FIELD #39, EXPLAIN.

INCIDENT REPORT: NOTE: IF SECTION 22 ABOVE HAS NUMBER 4 CHECKED, DO NOT GO BEYOND THIS LINE WITHOUT RECORDS SECTION BEING ADVISED, OR NO RECORD ENTRIES WILL BE MADE BELOW THIS LINE.

PROPERTY VALUE	26. PROPERTY	A. CURRENCY	B. JEWELRY	C. FURS CLOTHING	D. VEHICLE (LOCAL)	E. OFFICE EQUIPMENT	F. RADIO, TV CAMERAS	G. FIREARMS	H. HOUSE-HOLD GOODS
	STOLEN	\$	\$	\$	\$	\$	\$	\$	\$
	RECOVERED	\$	\$	\$	\$	\$	\$	\$	\$
	26. PROPERTY	I. CONSUM-ABLES	J. LIVESTOCK	K. DRUGS	L. MARINE ITEMS	M. CONSTRUCTION ITEMS	N. LAWN AND GARDEN	O. SPORTING GOODS	P. MISC BICYCLE
	STOLEN	\$	\$	\$	\$	\$	\$	\$	\$
	RECOVERED	\$	\$	\$	\$	\$	\$	\$	\$

27. PROPERTY RECOVERED: LOCALLY _____ OTHER JURISDICTION _____ (INSERT O OR L)

PROPERTY ITEMIZATION	PROPERTY STOLEN/RECOVERED ITEMIZATION, USE THE FOLLOWING FORMAT				
	28. QUANTITY	29. ARTICLE NAME	30. BRAND NAME	31. SERIAL NUMBER	32. CODE
					S R <input type="checkbox"/> <input type="checkbox"/>
					S R <input type="checkbox"/> <input type="checkbox"/>
					S R <input type="checkbox"/> <input type="checkbox"/>
					S R <input type="checkbox"/> <input type="checkbox"/>
					S R <input type="checkbox"/> <input type="checkbox"/>

33. PROPERTY DAMAGE AMOUNT \$ _____ 34. INSURANCE COMPANY _____

35. OFFICER ASSAULTED Y N 36. ARSON Y N 37. STRUCTURE CODE _____ 38. DAMAGE \$ _____

47. CIB	ENTERED <input type="checkbox"/>	CANCELLED <input type="checkbox"/>	48. TOTAL AMOUNT PROPERTY STOLEN \$ _____
NCIC	<input type="checkbox"/>	<input type="checkbox"/>	
OTHER BROADCAST	<input type="checkbox"/>	<input type="checkbox"/>	
			49. TOTAL AMOUNT PROPERTY RECOVERED \$ _____

50. IS REPORT CONTINUED? YES NO 51. CAUTION INDICATORS, ATLS ETC.

52. DATA PROCESS INFORMATION:

COMPUTER ENTERED DATE 5/17/09

MICROFILM INDEXED INITIAL KS

IS CASE CLASSIFICATION CORRECT? IF N HAS CORRECTION BEEN MADE? Y N

53. FILE APPROVAL

BY KP DATE 05/16/09

Manitowoc County Sheriff's Department

Thomas H. Kocourek
SHERIFF



Kenneth J. Petersen
INSPECTOR

H & R

4/13/99

[REDACTED]

[REDACTED]

observed a vehicle believed to be a Gun Metal Gray with what he thought to be Packerland Industrial with damage to the drivers side. He was unable to obtain the plate #

This was several weeks ago. Today he saw another Van with the same logs & got the plate of BH 78-002. This was on a white Dodge list to Packer City International Trucks Inc. Green Bay - [REDACTED] Hansen St P.O. Box [REDACTED]

check to see if they have or had Chevy Trucks

1. CASE # S99 No 02923 | 2. CLASSIFICATION 163011 | 3. CENSUS 701000

4. INCIDENT C91599-00242

5. INCIDENT LOCATION Elkart Lake

6. NAME - LAST - FIRST - MI Anon | 7. D.O.B.

8. ADDRESS | 9. TX-HOME

11. CITY STATE ZIP | 10. TX-BUSINESS

12. DETAILS
 BA416371 Brown Van
 w right front Grill damage
 Matches the picture

1715 41399

MANITOWOC COUNTY SHERIFF
INCIDENT CARD

18. ASSIGNED MTSO 9129

19. REC. BY 926 | 20. DIS. BY

21. HOW REC'D.
 1. 911
 2. POLICE RADIO
 3. PHONE
 4. TTY
 5. IN PERSON
 6. ON VIEW
 7. OFF. OFF DUTY
 8. C.B. RADIO
 9. OTHER

22. TYPE OF REPORT
 INCIDENT
 ACCIDENT
 CITATION
 NONE

23. STATUS
 UNFOUNDED
 PNL
 OTHER
 CLEARED
 EXCEPT CLEARED

24. DATE CLEARED 01/30/99

25. OFFENSE TYPE
 ADULT
 JUVENILE
 NA
 UNKNOWN

14. REC'D	15. DISP	16. 10-23	17. 10-24
13. DAY			
SUN 1		THU 5	
MON 2		FRI 6	
TUE 3		SAT 7	
WED 4			

39. (CODE S-SUSPECT W-WITNESS V-VICTIM O-OTHER)	40. NAME-LAST	FIRST	MI	41. D.O.B.	42. ADDRESS	43. TELEPHONE
O	Genes Sound and Camera		178573		██████ Erie Ave. Sheboygan	██████
O	Bauer, Jeffrey		178574		██████ Lakeshore Rd. Sheboygan	██████
W	Potochnik, Timothy M.		27373	██████	██████ N.4th St., Sheboygan	

04/16/99 2205hrs Attempted contact with Complainant, no answer.
 Contact made with Sheboygan PD and request made with dispatcher to have officer see if the vehicle in question may be parked outside at the business, if contact made phone me for description of damage. M.J.Bushman

Business closed hours 9-6 M,TU,TH-10-7 W,F.

Off.Veeser called back to say the vehicle was not at the business and gave me the name of the company's owner Jeffrey Bauer. The address is in the County, Veeser stated he will pass the information on to the AM Capt. for followup by making contact with owner and obtain explanation. M.J.Bushman

04/20/99 1720hrs Contact made by phone with Timothy Potochnik an employee of Genes Sound and Camera. Owners are not available. I explained the incident and he replied that vehicle is used by the Install Department and was currently parked outside the store until 1800hrs. He went out and found damage to molding with a pc. missing around the passenger headlamp. There is also a scrape along the right sliding door "which looks like someone sideswiped the van." No other damage, does not appear as if it had been repaired.

Contact made with Sheboygan PD and request to have Officer stop by to varify, PD called back 1740hrs, van now gone.

Contact made with Potchnik, vehicle in their basement, Sheboygan will return. M.J.Bushman

Last word was Sheboygan did not arrive in time to check the vehicle as the business did close, complaint will be passed on to next shift, and copy of report faxed to MTSO.

04/26/99 Received the report from Sheboygan Police Dept. reference their followup with the truck at Gene's Sound and Camera. The damage they viewed was consistant with the damage reported above. The Officer also had the opportunity to check under the hood. Several polaroid pictures were also sent. This would not be the vehicle we are looking for as the suspect. Close out. M.J.Bushman

Case # S99 No 0292

45. IF COMPLAINANT DIFFERENT THEN CALLER, ENTER NAME, ADDRESS, D.O.B., TELEPHONE.

46. IF CODE O (OTHER) IS USED IN FIELD #39, EXPLAIN.

INCIDENT REPORT: NOTE: IF SECTION 22 ABOVE HAS NUMBER 4 CHECKED, DO NOT GO BEYOND THIS LINE WITHOUT RECORDS SECTION BEING ADVISED, OR NO RECORD ENTRIES WILL BE MADE BELOW THIS LINE.

PROPERTY VALUE	26. PROPERTY	A. CURRENCY	B. JEWELRY	C. FURS CLOTHING	D. VEHICLE (LOCAL)	E. OFFICE EQUIPMENT	F. RADIO, TV CAMERAS	G. FIREARMS	H. HOUSE-HOLD GOODS
	STOLEN	\$	\$	\$	\$	\$	\$	\$	\$
	RECOVERED	\$	\$	\$	\$	\$	\$	\$	\$
	26. PROPERTY	I. CONSUMABLES	J. LIVESTOCK	K. DRUGS	L. MARINE ITEMS	M. CONSTRUCTION ITEMS	N. LAWN AND GARDEN	O. SPORTING GOODS	P. MISC BICYCLE
STOLEN	\$	\$	\$	\$	\$	\$	\$	\$	
RECOVERED	\$	\$	\$	\$	\$	\$	\$	\$	

27. PROPERTY RECOVERED: LOCALLY _____ OTHER JURISDICTION _____ (INSERT O OR L)

PROPERTY ITEMIZATION	PROPERTY STOLEN/RECOVERED ITEMIZATION, USE THE FOLLOWING FORMAT				
	28. QUANTITY	29. ARTICLE NAME	30. BRAND NAME	31. SERIAL NUMBER	32. CODE
					S R <input type="checkbox"/> <input type="checkbox"/>
					S R <input type="checkbox"/> <input type="checkbox"/>
					S R <input type="checkbox"/> <input type="checkbox"/>
					S R <input type="checkbox"/> <input type="checkbox"/>

33. PROPERTY DAMAGE AMOUNT \$ _____

34. INSURANCE COMPANY _____

35. OFFICER ASSAULTED Y N

36. ARSON Y N

37. STRUCTURE CODE _____ 38. DAMAGE \$ _____

47. CIB ENTERED CANCELLED
 NCIC
 OTHER BROADCAST

48. TOTAL AMOUNT PROPERTY STOLEN \$ _____

49. TOTAL AMOUNT PROPERTY RECOVERED \$ _____

50. IS REPORT CONTINUED? YES NO

51. CAUTION INDICATORS, ATLS ETC.

52. DATA PROCESS INFORMATION:

COMPUTER ENTERED DATE 1/6/99

MICROFILM INDEXED INITIAL RS

IS CASE CLASSIFICATION CORRECT? Y N
 IF N HAS CORRECTION BEEN MADE? Y N

53. FILE APPROVAL

BY [Signature] DATE 01/30/99

Manitowoc County Sheriff

4/21/99 Part 1
By User: PDJSS365

INCIDENT DETAIL PRINT
SHEBOYGAN POLICE DEPARTMENT

99-0013-593 Page 1

SERVICE INFORMATION

Sequence#: 1

How Receive: 02 Telephone District: 2 Date: 4/16/99 Day: 6 Time: 22:21
Nature.....: ASSIST Rcvd by:346 Dispatch by: 346 Shift 2
Location...: [REDACTED] ERIE AVENUE Apt:
City/State.: SHEBOYGAN WI

Vehicle Lic: BA46371 Vehicle ID #: State: WI Exp:

Reported by: MANITOWOC COUNTY SHERIFF DEPARTMENT
Location...: 1025 S 9 STREET Apt:
City/State.: MANITOWOC WI 54220 Sex:

Report Code: Arrests: Disposition: 007 Continued
ISC.....:9805 Incd Cd: 1 Police Incident CURRENT STATUS INFORMATION
UCR.....: 00 ASSIST OUTSIDE AUTHORITY Unit: 239 Disp Sit. resolved
Mult Calls: as of 4/21/99

ASSIGNED UNITS

Unit	Name	Jur	Type	Filed	Resp	T	Disp	Arrv	Clrd	Total
239	VEESER, JAMES	SHEB	P	F	2		22:22	22:22	22:34	12

FLW-UP

SERVICE INFORMATION

Sequence#: 2

How Receive: District: 2 Date: 4/20/99 Day: 3 Time: 18:04
Nature.....: FOLLOW UP Rcvd by:333 Dispatch by: 333 Shift 1
Location...: [REDACTED] CENTER AVENUE Apt:
City/State.: SHEBOYGAN WI

Vehicle Lic: Vehicle ID #: State: Exp:

Report Code: Arrests: Disposition: 007 Continued
ISC.....: Incd Cd:
UCR.....:

Mult Calls:

ASSIGNED UNITS

Unit	Name	Jur	Type	Filed	Resp	T	Disp	Arrv	Clrd	Total
261	FIETZER, TONY	SHEB	P	F	1		18:04	18:04	18:14	10

COPY

WARNING: THIS REPORT MAY BE
SUBJECT TO DISCOVERY PROTECTIVE
AND EVIDENCE INVESTIGATION
CHANGES MAY OCCUR.

Offense Rpt#: 1 CONTACT INFORMATION

----- CONTACT INFORMATION -----
Document: 1 Filed by: 239 Date: 4/16/99

Contact.....: MANITOWOC COUNTY SHERIFF DEPARTMENT D.O.B.: 0/00/00
Address.....: 1025 S 9 STREET
City/state...: MANITOWOC WI 54220
Sex.....: Race: Phone: [REDACTED]

Contact.....: Report. Person
Contact Date: 4/16/99 Desc.....: ASSIST OA
Report Type.: Offense Report Report No...: 990013593
Disposition.: Cleared Disp Date...: 4/16/99
Actions.....: Injury.....:
Circumstance: Victim type:

----- CONTACT INFORMATION -----
Document: 2 Filed by: 239 Date: 4/16/99

Contact.....: BAUER, JEFFREY E. D.O.B.: [REDACTED]
Address.....: [REDACTED] LAKESHORE ROAD
City/state...: SHEBOYGAN WI 53081
Sex.....: Male Race: White Phone: [REDACTED]

Contact.....: Citizen Contact
Contact Date: 4/16/99 Desc.....: ASSIST OA
Report Type.: Offense Report Report No...: 990013593
Disposition.: Continued Disp Date...: 4/16/99
Actions.....: Injury.....:
Circumstance: Victim type:

----- CONTACT INFORMATION -----
Document: 3 Filed by: 239 Date: 4/16/99

Contact.....: BUSHMAN, MICHAEL D.O.B.: 0/00/00
Address.....: C/O MANITOWOC SHERIFF
City/state...: MANITOWOC WI 54220
Sex.....: Race: Phone: 920) [REDACTED]

Contact.....: Citizen Contact
Contact Date: 4/16/99 Desc.....: ASSIST OA
Report Type.: Offense Report Report No...: 990013593
Disposition.: Cleared Disp Date...: 4/16/99
Actions.....: Injury.....:
Circumstance: Victim type:

4/21/99 Part 5
By User: PDJSS365

INCIDENT DETAIL PRINT
SHEBOYGAN POLICE DEPARTMENT

99-0013-593 Page 4

Offns Rpt#: 1

VEHICLE INFORMATION

Document: 1 Filed By: 239 Date: 4/16/99 Status: Other

Type: Truck/Bus	Year: 85	Make: CHEVROLET	Model:	
Wheel:	Body: Van	Top Color:	Bottom Color:	
License #	Registration No.	Year	Type	Vehicle ID. #
BA46371		00	T	
City	State	Ins. Co.		
	WI			
Recovery Cd:	Value:	.00	SID#:	CURRENT STATUS IN
				Other 19/99/0

Doc #: 1 Type: N Filed by: 239 Date: 4/16/99 COMPLETE

On 04/16/99, I, Off. Veeseer, was advised to respond to headquarters regarding assisting Manitowoc County Sheriff's Department with a hit and run investigation. I arrived at headquarters and was instructed to contact Lt. Michael Bushman, [REDACTED], of the Manitowoc County Sheriff's Department. I made contact with Lt. Bushman and he stated that there is information of a van that may have been involved in a hit and run investigation which occurred in Manitowoc County. The case number for the hit and run for Manitowoc County is S99-0023. Lt. Bushman wished this officer to check Gene's Sound and Camera [REDACTED] Erie Avenue, regarding a 1985 Chevrolet van, with plate BA46371 that registers to that business. I was instructed that the van should be brown in color with damage to the right of center in the front area of the van. I was advised that there may be grill damage to the front of the van. I advised him would proceed to that location regarding checking on the van.

I proceeded to Genes Sound and Camera where checking the lot found that no vehicles were present. I recontacted Lt. Bushman and advised him of the situation. I advised him that the owner of Genes Sound and Camera is Jeffrey Bauer, [REDACTED] Lakeshore Road, [REDACTED]. I told him that the van possibly could be at the owners residence but that it was in the county. I also told him that I would have day shift check Genes Sound and Camera regarding the van possibly being at that location the following day. I told him that regarding the residence, he may contact the Sheboygan County Sheriff's Department who could then check the residence on Lakeshore Road.

Due to the investigation involving a hit and run fatality, I told Lt. Bushman that I would have officers check that location and fax a copy of our report to their Sheriff's Department. The fax number is [REDACTED]. I will forward this to first shift regarding a follow up. Off. Veeseer/jss

cc: CID

4/21/99 Part 8
By User: PDJSS365

INCIDENT DETAIL PRINT
SHEBOYGAN POLICE DEPARTMENT

99-0013-593 Page 6

Doc #: 2 Type: N Filed by: 261 Date: 4/20/99 COMPLETE

On 04-20-99 at 1730 hours, I, Officer Fietzer, was dispatched to check [REDACTED] Erie Avenue, Gene's Sound and Camera, regarding a vehicle with Wisconsin plate BA46371, listing to a 1985 Chevrolet van. It should be noted that the reason officers are looking for this van is regarding a felony hit and run fatality in Manitowoc County earlier in the year.

I made contact at the location, however, there was no vehicle matching that description in the area.

I spoke to Lt. Derus, who advised that Manitowoc recontacted our department advising that the vehicle allegedly is underneath the building in an underground garage. Lt. Derus advised that upon receiving a hard copy in the form of a teletype requesting our assistance in attempting to locate this vehicle, we would attempt contact at Gene's and request permission to view the vehicle.

I did receive hard copy requesting our assistance, however, upon my return to Gene's Sound and Camera, they were already closed and no one was around. I advised Lt. Derus of this and he advised that he would make first shift aware and request them to follow up on it. I cleared. OFF. FIETZER/ljn

cc: CID / Shift 1 Supervision

Doc #: 3 Type: N Filed by: 143 Date: 4/21/99 COMPLETE

On 04/21/99, I was assigned to check at [REDACTED] Erie Avenue, Genes Sound and Camera regarding a vehicle with Wisconsin plates BA46371, listing on a 1985 Chevrolet van. This is in regard to a felony hit and run fatality that occurred in Manitowoc county earlier this year.

I made contact with the owner of Genes Camera, Jeffrey E. Bauer, [REDACTED] Lakeshore Drive Road, Sheboygan, WI 53081, dob [REDACTED]. I advised Mr. Bauer as to why I was contacting him and he stated he did receive some phone call from the Manitowoc Sheriff's Department in regard to a vehicular homicide that occurred that his vehicle may have been involved in that accident. I had asked Jeffrey if he still had that vehicle and he replied yes, that it was in the garage, which is located underneath the building in an underground garage service area. I had asked if I could see the van in question, which is in the garage and he stated, "come on down". We then went down into the garage area underneath the building.

There was a 1985 Chevrolet panel truck, bearing Wisconsin registration BA46371, expires 3/00, listed to Genes Sound and Camera, [REDACTED] Erie Avenue, Sheboygan 53081. The van has been re-painted dark brown, approx. ten years ago and upon looking at the front end of the vehicle, the right rectangle plastic housing is broken and missing at this time. Jeffrey stated that he had taken the business over from his father who passed away approx. eight years ago and the damage was there when he took over the business.

In checking the front grille, that appeared to be intact and the Chevrolet emblem was still attached to the middle of the grille. There was no apparent damage to the hood or to the fan housing on top of the engine. Upon closer examination, the grille has all kinds of nicks and scratches that are due to being on the road being hit by gravel and stones by other vehicles along with some bug debris. It does appear, at one point, the front grille was also re-painted a gray or silver with a spray can, probably at the same time the van was re-painted.

I did take a total of five polaroid pictures of this 1985 Chevrolet panel truck. Picture No. one shows a frontal shot of the vehicle, along with the license plate number and a portion of the right front grille housing that is missing on the truck. Picture No. two is a closeup of the same shot of the damaged right front headlight housing, picture three shows the center portion of the plastic grille which is intact and also the upper portion of the hood of the truck. The fourth picture shows that the right rear sliding door is damaged and creased as the driver cut the corner too short, hitting the concrete post outside the garage while making a turn and picture No. five shows a picture of the top portion of the engine showing that the plastic

housing was intact.

I then made telephone contact with the shift supervisor at Manitowoc County Sheriff's Department and he advised that I should page Lt. Michael Bushman on his pager. The pager number would be [REDACTED] and give him this information regarding what we found, as far as the damage on this truck.

I then called the pager and at the time of this report, I have not received a call back from Lt. Bushman.

If you would send a copy of this report, along with the five polaroid pictures to the Manitowoc County Sheriff's Department c/o Lt. Michael Bushman. Off. Zittel/jss

cc: Manitowoc Co. Sheriff - Lt. Michael Bushman
CID

1. CASE # S99 No 02925 | 2. CLASSIFICATION 6301 | 3. CENSUS 52000

4. INCIDENT CS/S99-00242

5. INCIDENT LOCATION

6. NAME - LAST - FIRST - MI Anon | 7. D.O.B.

8. ADDRESS | 9. TX-HOME

11. CITY STATE ZIP | 10. TX-BUSINESS

12. DETAILS See attached form

17:30 4-13-99

14. REC'D	15. DISP	16. 10-23	17. 10-24
13. DAY			
SUN 1	THU 5		
MON 2	FRI 6		
<u>TUE 3</u>	SAT 7		
WED 4			

MANITOWOC COUNTY SHERIFF
INCIDENT CARD

18. ASSIGNED
Weyker 406

19. REC. BY 926 | 20. DIS. BY

21. HOW REC'D.
1. 911
2. POLICE RADIO
3. PHONE
4. TTY
5. IN PERSON
6. ON VIEW
7. OFF. OFF DUTY
8. C.B. RADIO
9. OTHER

22. TYPE OF REPORT
1. INCIDENT
2. ACCIDENT
3. CITATION
4. NONE

23. STATUS
1. UNFOUNDED
2. PNL
3. OTHER
4. CLEARED
5. EXCEPT CLEARED

24. DATE CLEARED 04/30/99

25. OFFENSE TYPE
1. ADULT NA
2. JUVENILE
3. UNKNOWN

39. (CODE S-SUSPECT W-WITNESS V-VICTIM O-OTHER)

CODE	40. NAME - LAST	FIRST	MI	41. D.O.B.	42. ADDRESS	43. TELEPHONE

04/13/99 1730 hrs. Officer Weyker, met with an anonymous complainant at MTSO. The complainant wished to report what she believed to be suspicious activity. She stated that she normally rides her horse on property south of Carstens Lake Rd to the east of Gass Lake Rd. On today's date she was approached by a young male subject who identified himself as [REDACTED]. She stated [REDACTED] asked her not to ride her horse on the [REDACTED] property. He stated that there was something in the woods that they did not want disturbed. The complainant felt it was somewhat suspicious that they did not want anyone riding horses in the woods. She feels there may be something in the woods that they are trying to hide. The complainant acknowledged that she had never asked for permission to ride on this property in the past.

04/17/99 I, Officer Weyker, met with RUTH NIELSEN at her residence. I informed NIELSEN of this complaint. NIELSEN stated that she did not want anyone riding horses on their property because she was concerned they would damage the vegetation in the woods and disturb the habitat. NIELSEN stated that this person had never asked for permission to ride the horse on her property. She was somewhat upset that someone would trespass on her property without first obtaining permission. NIELSEN assured me that there was nothing in the woods that they were trying to hide. She stated she was only concerned about possible damage to the habitat by the horses. NIELSEN did grant me permission to check the woods. This is a very small wood lot with very little underbrush. The majority of the woods could be viewed from the outside. Due to the very wet, muddy conditions from recent rains I was unable to walk throughout the entire woods. I did however view the woods from the edges and was unable to view any vehicles parked within the woods. It appeared it would be very difficult to conceal a vehicle in the woods. Based on the information obtained, no further action was taken.

D.Weyker/ks

S99 No 02925

45. IF COMPLAINANT DIFFERENT THEN CALLER, ENTER NAME, ADDRESS, D.O.B., TELEPHONE.

46. IF CODE O (OTHER) IS USED IN FIELD #39, EXPLAIN.

INCIDENT REPORT: NOTE: IF SECTION 22 ABOVE HAS NUMBER 4 CHECKED, DO NOT GO BEYOND THIS LINE WITHOUT RECORDS SECTION BEING ADVISED, OR NO RECORD ENTRIES WILL BE MADE BELOW THIS LINE.

PROPERTY VALUE	26. PROPERTY	A. CURRENCY	B. JEWELRY	C. FURS CLOTHING	D. VEHICLE (LOCAL)	E. OFFICE EQUIPMENT	F. RADIO, TV CAMERAS	G. FIREARMS	H. HOUSE-HOLD GOODS
	STOLEN	\$	\$	\$	\$	\$	\$	\$	\$
	RECOVERED	\$	\$	\$	\$	\$	\$	\$	\$
	26. PROPERTY	I. CONSUMABLES	J. LIVESTOCK	K. DRUGS	L. MARINE ITEMS	M. CONSTRUCTION ITEMS	N. LAWN AND GARDEN	O. SPORTING GOODS	P. MISC BICYCLE
STOLEN	\$	\$	\$	\$	\$	\$	\$	\$	
RECOVERED	\$	\$	\$	\$	\$	\$	\$	\$	

27. PROPERTY RECOVERED: LOCALLY _____ OTHER JURISDICTION _____ (INSERT O OR L)

PROPERTY ITEMIZATION	PROPERTY STOLEN/RECOVERED ITEMIZATION, USE THE FOLLOWING FORMAT			
	28. QUANTITY	29. ARTICLE NAME	30. BRAND NAME	31. SERIAL NUMBER
				S R <input type="checkbox"/> <input type="checkbox"/>
				S R <input type="checkbox"/> <input type="checkbox"/>
				S R <input type="checkbox"/> <input type="checkbox"/>
				S R <input type="checkbox"/> <input type="checkbox"/>
				S R <input type="checkbox"/> <input type="checkbox"/>
				S R <input type="checkbox"/> <input type="checkbox"/>

33. PROPERTY DAMAGE AMOUNT \$ _____

34. INSURANCE COMPANY _____

35. OFFICER ASSAULTED Y N

36. ARSON Y N

37. STRUCTURE CODE _____

38. DAMAGE \$ _____

47. CIB ENTERED CANCELLED
 NCIC
 OTHER BROADCAST

48. TOTAL AMOUNT PROPERTY STOLEN \$ _____

49. TOTAL AMOUNT PROPERTY RECOVERED \$ _____

50. IS REPORT CONTINUED? YES NO

51. CAUTION INDICATORS, ATLS ETC.

52. DATA PROCESS INFORMATION:

COMPUTER ENTERED DATE 16/09/99
 MICROFILM INDEXED INITIAL KS

53. FILE APPROVAL

IS CASE CLASSIFICATION CORRECT?
 IF N HAS CORRECTION BEEN MADE? Y N

BY [Signature] DATE 09/08/99

See Manitowoc Rapids Page 24

MANITOWOC

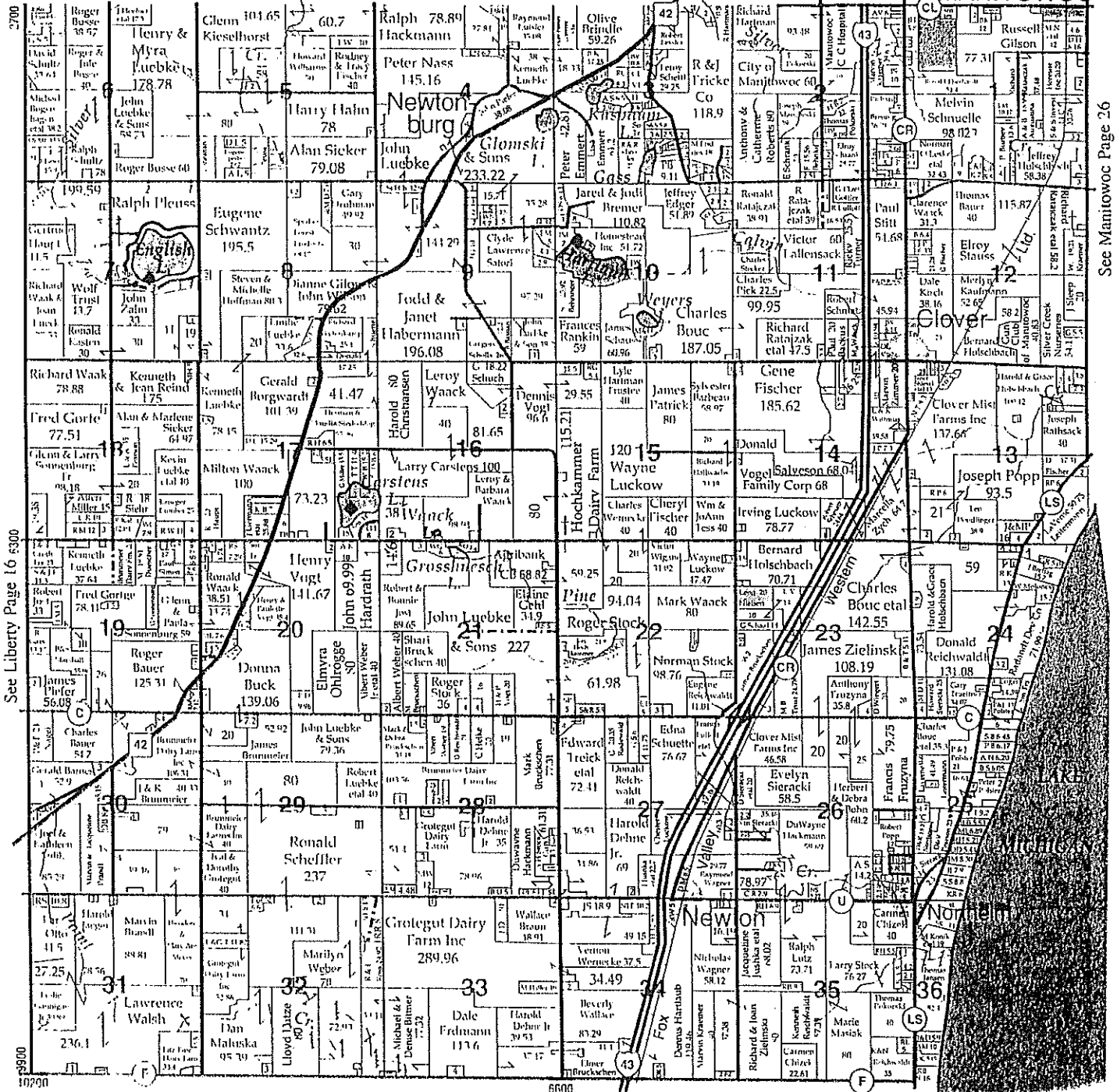

2700

See Liberty Page 16 #300

10700

See Manitowoc Page 26

See Centerville Page 12

Stock & Dinner Club
 Weekly & Sunday Special
 Serving Tues-Sat 5 p.m.
 Sunday 11 a.m.
 Phone: [Redacted]

ACE BUILDING SERVICE INC.
 Commercial & Industrial Building Construction
 Marshall Street • PO Box
 Manitowoc, WI 54221-1626

1. CASE # S99 No 03235	2. CLASSIFICATION 631011	3. CENSUS 701000
4. INCIDENT CS/ See 599-00242		
5. INCIDENT LOCATION SHEBOYGAN		
6. NAME- LAST-FIRST-MI [REDACTED]	7. D.O.B. 127593	
8. ADDRESS [REDACTED]	9. TX-HOME [REDACTED]	
11. CITY [REDACTED]	10. TX-BUSINESS [REDACTED]	
12. DETAILS COMPL. REPORTS OBSERVING CHEV BLAZER IN SHEB. W/ FRT. DAMAGE (SEE ATTACHED)		

1115 04-24-99
 1150 04-24-99
 14. REC'D
 15. DISP
 16. 10-23
 17. 10-24
 13. DAY
 SUN 1 THU 5
 MON 2 FRI 6
 TUE 3 SAT 7
 WED 4

MANITOWOC COUNTY SHERIFF INCIDENT CARD	
18. ASSIGNED MTSO	929
COLBORN	432
19. REC. BY 930	20. DIS. BY 930
21. HOW REC'D. 1. 911 2. POLICE RADIO 3. PHONE 4. TTY 5. IN PERSON 6. ON VIEW 7. OFF. OFF DUTY 8. C.B. RADIO 9. OTHER	22. TYPE OF REPORT <input checked="" type="checkbox"/> 1. INCIDENT <input type="checkbox"/> 2. ACCIDENT <input type="checkbox"/> 3. CITATION <input type="checkbox"/> 4. NONE <input type="checkbox"/> 23. STATUS <input type="checkbox"/> 1. UNFOUNDED <input type="checkbox"/> 2. PNL <input type="checkbox"/> 3. OTHER <input type="checkbox"/> 4. CLEARED <input type="checkbox"/> 5. EXCEPT CLEARED <input type="checkbox"/> 24. DATE CLEARED <input type="checkbox"/> 25. OFFENSE TYPE <input type="checkbox"/> 1. ADULT <input type="checkbox"/> NA <input type="checkbox"/> <input type="checkbox"/> 2. JUVENILE <input type="checkbox"/> <input type="checkbox"/> 3. UNKNOWN <input type="checkbox"/>
21A. M.O.	

39. (CODE S-SUSPECT W-WITNESS V-VICTIM O-OTHER)	40. NAME- LAST	FIRST	MI	41. D.O.B.	42. ADDRESS	43. TELEPHONE
0	[REDACTED]	[REDACTED]	[REDACTED]	[REDACTED]	[REDACTED]	[REDACTED]
0	PELOQUIN	SUSAN	C	[REDACTED]	Eisner Ave, Sheboygan	

04/24/99 @ 1115 Hrs.: I, Deputy Colborn, was assigned this incident by MTSO Dispatch. Preliminary information received was that while operating her vehicle north on STH 42, the complainant had observed a black Chevy Blazer, unknown registration, with a damaged grille.

This caller, who identified herself as [REDACTED] stated that the vehicle was in Sheboygan Co. on STH 42.

I recontacted [REDACTED] at her residence on Washington Ave. [REDACTED] stated the vehicle was in the vicinity of Dairyland Dr. on STH 42. [REDACTED] stated that the passenger side portion of the grille was broken out and that she believed the vehicle was for sale.

I did respond to STH 42 in the vicinity of Dairyland Dr. in Sheboygan Co. where I located this vehicle. I observed this vehicle to bear WI RP NSAS769. I further observed a small portion of the grille to be broken out, however, there was no sheet metal damage whatsoever. The hood and fender was intact as was the bumper. Also, the windshield was free of any damage. Also, it appeared that the radiator upper support and fan shroud were in place and not damaged.

I then made contact with SUSAN PELOQUIN who identified herself as the girlfriend of the owner. SUSAN stated that her boyfriend had damaged the grille of the Blazer while ice fishing and apparently the vehicle fell through the ice.

Due to the fact that the vehicle is absent of any sheet metal damage and/or windshield damage and only a small portion of the grille is broken out of the front of the vehicle, I do not believe this vehicle to be the suspect vehicle for Incident #S99-00242.

No further action taken at this time.

A copy of this incident to be forwarded to Incident Commander, Lt. Bushman and Deputy Raube for entry into the FBI Quick Start Program. AColborn /paf

1. CASE # S99 No 02587 2. CLASSIFICATION 6.310.11 3. CENSUS 52000

MANITOWOC COUNTY SHERIFF
INCIDENT CARD

4. INCIDENT CS / See S99-00242

18. ASSIGNED MTS 0 9129

5. INCIDENT LOCATION NORTH END KNUELL STR.

DHEARN 456

6. NAME LAST-FIRST-MI [REDACTED] 7. D.O.B. (4020)

9. TX-HOME [REDACTED]

11. CITY STATE ZIP 10. TX-BUSINESS [REDACTED]

12. DETAILS COMPL. REPORTS TRK. BJ 16840

IS PARKED @ N. end OF KNUELL

NOW; BELIEVES IT MAY BE A

SUSPECT VEH. IN H+R INCID.

SEE ATTACHED.

REC'D 0700 04/01/99
DISP 0723 04/01/99
10-23 0726 04/01/99
10-24

19. REC. BY 930 20. DIS. BY

21. HOW REC'D.
1. 911
2. POLICE RADIO
3. PHONE
4. TTY
5. IN PERSON
6. ON VIEW
7. OFF. OFF DUTY
8. C.B. RADIO
9. OTHER

22. TYPE OF REPORT
1. INCIDENT
2. ACCIDENT
3. CITATION
4. NONE

23. STATUS
1. UNFOUNDED
2. PNL
3. OTHER
4. CLEARED
5. EXCEPT CLEARED

24. DATE CLEARED 04/02/99

25. OFFENSE TYPE
1. ADULT NA
2. JUVENILE
3. UNKNOWN

13. DAY
SUN 1 THU 5
MON 2 FRI 6
TUE 3 SAT 7
WED 4

39. (CODE S-SUSPECT W-WITNESS V-VICTIM O-OTHER)				41. D.O.B.	42. ADDRESS	43. TELEPHONE
CODE	40. NAME-LAST	FIRST	MI			

0723 hrs. 4/1/99 Officer recd. information about this vehicle and went to the area to check on the vehicle. Officer ran the palte and it came back to a Paul D. Schultz. 87 chev. trk. The vehicle was in good condition and does not look as if it has been damaged or fixed. Entry into computer completed. TKO

TKO

Please make entry onto computer. TKO

ENTERED ETC

45. IF COMPLAINANT DIFFERENT THEN CALLER, ENTER NAME, ADDRESS, D.O.B., TELEPHONE.

46. IF CODE O (OTHER) IS USED IN FIELD #39, EXPLAIN.

INCIDENT REPORT: NOTE: IF SECTION 22 ABOVE HAS NUMBER 4 CHECKED, DO NOT GO BEYOND THIS LINE WITHOUT RECORDS SECTION BEING ADVISED, OR NO RECORD ENTRIES WILL BE MADE BELOW THIS LINE.

PROPERTY VALUE	26. PROPERTY	A. CURRENCY	B. JEWELRY	C. FURS CLOTHING	D. VEHICLE (LOCAL)	E. OFFICE EQUIPMENT	F. RADIO, TV CAMERAS	G. FIREARMS	H. HOUSE-HOLD GOODS
	STOLEN	\$	\$	\$	\$	\$	\$	\$	\$
	RECOVERED	\$	\$	\$	\$	\$	\$	\$	\$
	26. PROPERTY	I. CONSUMABLES	J. LIVESTOCK	K. DRUGS	L. MARINE ITEMS	M. CONSTRUCTION ITEMS	N. LAWN AND GARDEN	O. SPORTING GOODS	P. MISC BICYCLE
STOLEN	\$	\$	\$	\$	\$	\$	\$	\$	
RECOVERED	\$	\$	\$	\$	\$	\$	\$	\$	

27. PROPERTY RECOVERED: LOCALLY _____ OTHER JURISDICTION _____ (INSERT O OR L)

PROPERTY ITEMIZATION	PROPERTY STOLEN/RECOVERED ITEMIZATION, USE THE FOLLOWING FORMAT				
	28. QUANTITY	29. ARTICLE NAME	30. BRAND NAME	31. SERIAL NUMBER	32. CODE
					S R <input type="checkbox"/> <input type="checkbox"/>
					S R <input type="checkbox"/> <input type="checkbox"/>
					S R <input type="checkbox"/> <input type="checkbox"/>
					S R <input type="checkbox"/> <input type="checkbox"/>

33. PROPERTY DAMAGE AMOUNT \$ _____

34. INSURANCE COMPANY _____

35. OFFICER ASSAULTED Y N

36. ARSON Y N

37. STRUCTURE CODE _____

38. DAMAGE \$ _____

47. CIB ENTERED CANCELLED
 NCIC
 OTHER BROADCAST

48. TOTAL AMOUNT PROPERTY STOLEN \$ _____

49. TOTAL AMOUNT PROPERTY RECOVERED \$ _____

50. IS REPORT CONTINUED? YES NO

51. CAUTION INDICATORS, ATLS ETC.

52. DATA PROCESS INFORMATION:

COMPUTER ENTERED DATE 10 29 99
 MICROFILM INDEXED INITIAL KS

53. FILE APPROVAL

BY GK

DATE 10/12/99

IS CASE CLASSIFICATION CORRECT?
 IF N HAS CORRECTION BEEN MADE?

Y N
 N

1. CASE # S99 No 02650 2. CLASSIFICATION 630.11 3. CENSUS 5,210,00

4. INCIDENT CS / S99-00242

5. INCIDENT LOCATION N. 9th St. - City News in Mtwc.

6. NAME LAST-FIRST-MI ANONU (2) 7. D.O.B.

8. ADDRESS 9. TX-HOME 10. TX-BUSINESS

11. CITY STATE ZIP

12. DETAILS See Attached.

04-03-99 1536
 REC'D 14. 15. 16. 17.
 DISP 10-23 10-24
 13. DAY
 SUN 1 THU 5
 MON 2 FRI 6
 TUE 3 SAT 7
 WED 4

MANITOWOC COUNTY SHERIFF
 INCIDENT CARD

18. ASSIGNED MTSO 91219

19. REC. BY 938 20. DIS. BY

21. HOW REC'D.
 1. 911
 2. POLICE RADIO
 3. PHONE
 4. TTY
 5. IN PERSON
 6. ON VIEW
 7. OFF. OFF DUTY
 8. C.B. RADIO
 9. OTHER

22. TYPE OF REPORT
 1. INCIDENT
 2. ACCIDENT
 3. CITATION
 4. NONE

23. STATUS
 1. UNFOUNDED
 2. PNL
 3. OTHER
 4. CLEARED
 5. EXCEPT CLEARED

24. DATE CLEARED 10/12/99

25. OFFENSE TYPE
 1. ADULT NA
 2. JUVENILE
 3. UNKNOWN

39. (CODE S-SUSPECT W-WITNESS V-VICTIM O-OTHER)

CODE	40. NAME-LAST	FIRST	MI	41. D.O.B.	42. ADDRESS	43. TELEPHONE

04-03-99 MTPD rec'd thia call and Officer Weyer was dispatched to check the veh. However, upon officer arrival veh. was gone.

04/07/99 This vehicle has been checked before in Comp# S99-00689, Close.M.J. Bush

938/KB
 12/15

45. IF COMPLAINANT DIFFERENT THEN CALLER, ENTER NAME, ADDRESS, D.O.B., TELEPHONE.

46. IF CODE O (OTHER) IS USED IN FIELD #39, EXPLAIN.

INCIDENT REPORT: NOTE: IF SECTION 22 ABOVE HAS NUMBER 4 CHECKED, DO NOT GO BEYOND THIS LINE WITHOUT RECORDS SECTION BEING ADVISED, OR NO RECORD ENTRIES WILL BE MADE BELOW THIS LINE.

PROPERTY VALUE	26. PROPERTY	A. CURRENCY	B. JEWELRY	C. FURS CLOTHING	D. VEHICLE (LOCAL)	E. OFFICE EQUIPMENT	F. RADIO, TV CAMERAS	G. FIREARMS	H. HOUSE-HOLD GOODS
	STOLEN	\$	\$	\$	\$	\$	\$	\$	\$
	RECOVERED	\$	\$	\$	\$	\$	\$	\$	\$
	26. PROPERTY	I. CONSUMABLES	J. LIVESTOCK	K. DRUGS	L. MARINE ITEMS	M. CONSTRUCTION ITEMS	N. LAWN AND GARDEN	O. SPORTING GOODS	P. MISC BICYCLE
STOLEN	\$	\$	\$	\$	\$	\$	\$	\$	
RECOVERED	\$	\$	\$	\$	\$	\$	\$	\$	

27. PROPERTY RECOVERED: LOCALLY _____ OTHER JURISDICTION _____ (INSERT O OR L)

PROPERTY ITEMIZATION	PROPERTY STOLEN/RECOVERED ITEMIZATION, USE THE FOLLOWING FORMAT				32. CODE
	28. QUANTITY	29. ARTICLE NAME	30. BRAND NAME	31. SERIAL NUMBER	
					S <input type="checkbox"/> R <input type="checkbox"/>
					S <input type="checkbox"/> R <input type="checkbox"/>
					S <input type="checkbox"/> R <input type="checkbox"/>
					S <input type="checkbox"/> R <input type="checkbox"/>
					S <input type="checkbox"/> R <input type="checkbox"/>
					S <input type="checkbox"/> R <input type="checkbox"/>

33. PROPERTY DAMAGE AMOUNT \$ _____ 34. INSURANCE COMPANY _____

35. OFFICER ASSAULTED Y N 36. ARSON Y N 37. STRUCTURE CODE _____ 38. DAMAGE \$ _____

47. CIB ENTERED CANCELLED
 NCIC
 OTHER BROADCAST

48. TOTAL AMOUNT PROPERTY STOLEN \$ _____
 49. TOTAL AMOUNT PROPERTY RECOVERED \$ _____

50. IS REPORT CONTINUED? YES NO 51. CAUTION INDICATORS, ATLS ETC.

52. DATA PROCESS INFORMATION:
 COMPUTER ENTERED DATE 16/09/99
 MICROFILM INDEXED INITIAL KS
 IS CASE CLASSIFICATION CORRECT? Y N
 IF N HAS CORRECTION BEEN MADE? Y N

53. FILE APPROVAL
 BY [Signature] DATE 16/09/99

1. CASE # **S99 No 02651** 2. CLASSIFICATION **6,3|0,1|** 3. CENSUS **7,0|0,0|0**

4. INCIDENT **CS/S99-00242**

5. LOCATION **Manigan County**

6. REPORTER **Anonymous** 7. D.O.B.

8. ADDRESS 9. TX-HOME

11. CITY STATE ZIP 10. TX-BUSINESS

12. DETAILS **See Attached**

04/03/99 1559

14. REC'D	15. DISP	16. 10-23	17. 10-24
13. DAY			
SUN 1	THU 5		
MON 2	FRI 6		
TUE 3	SAT 7		
WED 4			

**MANITOWOC COUNTY SHERIFF
INCIDENT CARD**

18. ASSIGNED **MTSO** 9 | 2 | 9

19. REC. BY **935** 20. DIS. BY

22. TYPE OF REPORT
 1. INCIDENT
 2. ACCIDENT
 3. CITATION
 4. NONE

21. HOW REC'D.
 1. 911
 2. POLICE RADIO
 3. PHONE
 4. TTY
 5. IN PERSON
 6. ON VIEW
 7. OFF. OFF DUTY
 8. C.B. RADIO
 9. OTHER

23. STATUS
 1. UNFOUNDED
 3. OTHER
 4. CLEARED
 5. EXCEPT CLEARED

24. DATE **CLEARED 10/20/99**

21A. M.O.

25. OFFENSE TYPE
 1. ADULT NA
 2. JUVENILE
 3. UNKNOWN

39. (CODE S-SUSPECT W-WITNESS V-VICTIM O-OTHER)	40. NAME-LAST	FIRST	MI	41. D.O.B.	42. ADDRESS	43. TELEPHONE

04/07/99 This vehicle has been checked before in Comp# S99-02304, Close. M.J. Bushman

45. IF COMPLAINANT DIFFERENT THEN CALLER, ENTER NAME, ADDRESS, D.O.B., TELEPHONE.

46. IF CODE O (OTHER) IS USED IN FIELD #39, EXPLAIN.

INCIDENT REPORT: NOTE: IF SECTION 22 ABOVE HAS NUMBER 4 CHECKED, DO NOT GO BEYOND THIS LINE WITHOUT RECORDS SECTION BEING ADVISED, OR NO RECORD ENTRIES WILL BE MADE BELOW THIS LINE.

PROPERTY VALUE	26. PROPERTY	A. CURRENCY	B. JEWELRY	C. FURS CLOTHING	D. VEHICLE (LOCAL)	E. OFFICE EQUIPMENT	F. RADIO, TV CAMERAS	G. FIREARMS	H. HOUSE-HOLD GOODS
	STOLEN	\$	\$	\$	\$	\$	\$	\$	\$
	RECOVERED	\$	\$	\$	\$	\$	\$	\$	\$
	26. PROPERTY	I. CONSUM-ABLES	J. LIVESTOCK	K. DRUGS	L. MARINE ITEMS	M. CONSTRUCTION ITEMS	N. LAWN AND GARDEN	O. SPORTING GOODS	P. MISC BICYCLE
	STOLEN	\$	\$	\$	\$	\$	\$	\$	\$
	RECOVERED	\$	\$	\$	\$	\$	\$	\$	\$

27. PROPERTY RECOVERED: LOCALLY ____ OTHER JURISDICTION ____ (INSERT O OR L)

PROPERTY ITEMIZATION	PROPERTY STOLEN/RECOVERED ITEMIZATION, USE THE FOLLOWING FORMAT				
	28. QUANTITY	29. ARTICLE NAME	30. BRAND NAME	31. SERIAL NUMBER	32. CODE
					S R <input type="checkbox"/> <input type="checkbox"/>
					S R <input type="checkbox"/> <input type="checkbox"/>
					S R <input type="checkbox"/> <input type="checkbox"/>
					S R <input type="checkbox"/> <input type="checkbox"/>

33. PROPERTY DAMAGE AMOUNT \$ _____ 34. INSURANCE COMPANY _____

35. OFFICER ASSAULTED Y N 36. ARSON Y N 37. STRUCTURE CODE _____ 38. DAMAGE \$ _____

47. CIB	ENTERED <input type="checkbox"/>	CANCELLED <input type="checkbox"/>	48. TOTAL AMOUNT PROPERTY STOLEN \$ _____
NCIC	<input type="checkbox"/>	<input type="checkbox"/>	
OTHER BROADCAST	<input type="checkbox"/>	<input type="checkbox"/>	49. TOTAL AMOUNT PROPERTY RECOVERED \$ _____

50. IS REPORT CONTINUED? YES NO 51. CAUTION INDICATORS, ATLS ETC.

52. DATA PROCESS INFORMATION:

COMPUTER ENTERED DATE 16 09 99

MICROFILM INDEXED INITIAL AS

IS CASE CLASSIFICATION CORRECT? Y N

IF N HAS CORRECTION BEEN MADE? Y N

53. FILE APPROVAL

BY JMR DATE 04/20/99

1. CASE # **S99 No 02666** | 2. CLASSIFICATION **6.310.11** | 3. CENSUS **5.21000**

4. INCIDENT **CS/S99-0a242**

5. INCIDENT LOCATION **NEW HOLSTEIN**

6. NAME-LAST-FIRST-MI **CASO (205)** | 7. D.O.B.

8. ADDRESS | 9. TX-HOME

11. CITY | STATE | ZIP | 10. TX-BUSINESS

12. DETAILS
CASO rec'd info of Blazer/white with blue trim - grill damage. RP V6474T. Vehicle was seen at Kwik Trip in New Holstein.

6970 040499
 0970 040499
 14. REC'D | 15. DISP | 16. 10-23 | 17. 10-24
 13. DAY
 SUN 1 | THU 5
 MON 2 | FRI 6
 TUE 3 | SAT 7
 WED 4

MANITOWOC COUNTY SHERIFF INCIDENT CARD

18. ASSIGNED **MTSO** | **9/21/99**

19. REC. BY **922** | 20. DIS. BY **922**

21. HOW REC'D.
 1. 911
 2. POLICE RADIO
 3. PHONE
 4. TTY
 5. IN PERSON
 6. ON VIEW
 7. OFF. OFF DUTY
 8. C.B. RADIO
 9. OTHER
 21A. M.O.

22. TYPE OF REPORT
 1. INCIDENT
 2. ACCIDENT
 3. CITATION
 4. NONE

23. STATUS
 1. UNFOUNDED
 2. PNL
 3. OTHER
 4. CLEARED
 5. EXCEPT CLEARED

24. DATE CLEARED **09/30/99**

25. OFFENSE TYPE
 1. ADULT NA
 2. JUVENILE
 3. UNKNOWN

39. (CODE S-SUSPECT W-WITNESS V-VICTIM O-OTHER)						
CODE	40. NAME-LAST	FIRST	MI	41. D.O.B.	42. ADDRESS	43. TELEPHONE
0	Treland, Cheryl	178579			RR 4 Box [redacted] Hayward 54843	
0	Calumet Co. SO					[redacted]
0	Sawyer Co. SO				Fax: [redacted]	[redacted]

04/09/99 Contact made with Calumet Co. SO, vehicle was not located.

If contact with CASO is necessary, refer to CODE #31, which is their CS #.LBJ/922 PSJS

04/06/99 2354hrs Sawyer County SO. A vehicle registration V6474T/CVG lists to Cheryl Treland RR 4 Box [redacted] Hayward 54843. It was seen in our area with damage to the grill. Before Off's found the vehicle to make contact it was gone. I realize the plate listed does not match the described vehicle below however perhaps the plates have been switched around. I am requesting contact be made and view the Blazer white with blue trim if it is infact there. Listed below is a description of the complaint this report is refering too. Please obtain an explanation of damage and where I could find an accident report if one was filed. I work 2000hrs -0400hrs if you have any questions of need further detail. [redacted] Fax [redacted] Lt.M.J.Bushman

Fax sent to Sawyer Co.SO.

04/16/99 2314hrs Contact made by phone with Sawyer Co. dispatcher. She advised she remembered the TTY and that Officers did go to the residence as requested. She did not know what happened and if a complaint was started. She advise the best would be to call Monday and ask for dispatcher BOB Sabin who gave out the call, he works 8AM-4PM. M.J.Bushman

04/20/99 1700hrs Call placed to Sawyer County. Respondant stated she will check on the whereabouts of the report and fax me a copy. She remembered reading the report. M.J.Bushman

04/22/99 0830hrs Sgt. Anderson(Sawyer Co. SO) advised the registration V6474T and vehicle in question has been in the garage all winter as well as the plates. Owner is known by Sgt. Anderson and he does not believe the plates would have been removed nor placed on any other vehicle. If there were any more questions we should feel free to call him.

Vehicle and registration checked, does not match, perhaps the registration was misread. Close out report. M.J.Bushman

S99
 No
 00070 02000

45. IF COMPLAINANT DIFFERENT THEN CALLER, ENTER NAME, ADDRESS, D.O.B., TELEPHONE.

46. IF CODE O (OTHER) IS USED IN FIELD #39, EXPLAIN.

INCIDENT REPORT: NOTE: IF SECTION 22 ABOVE HAS NUMBER 4 CHECKED, DO NOT GO BEYOND THIS LINE WITHOUT RECORDS SECTION BEING ADVISED, OR NO RECORD ENTRIES WILL BE MADE BELOW THIS LINE.

PROPERTY VALUE	26. PROPERTY	A. CURRENCY	B. JEWELRY	C. FURS CLOTHING	D. VEHICLE (LOCAL)	E. OFFICE EQUIPMENT	F. RADIO, TV CAMERAS	G. FIREARMS	H. HOUSE-HOLD GOODS
	STOLEN	\$	\$	\$	\$	\$	\$	\$	\$
	RECOVERED	\$	\$	\$	\$	\$	\$	\$	\$
	26. PROPERTY	I. CONSUMABLES	J. LIVESTOCK	K. DRUGS	L. MARINE ITEMS	M. CONSTRUCTION ITEMS	N. LAWN AND GARDEN	O. SPORTING GOODS	P. MISC BICYCLE
	STOLEN	\$	\$	\$	\$	\$	\$	\$	\$
	RECOVERED	\$	\$	\$	\$	\$	\$	\$	\$

27. PROPERTY RECOVERED: LOCALLY _____ OTHER JURISDICTION _____ (INSERT O OR L)

PROPERTY ITEMIZATION	PROPERTY STOLEN/RECOVERED ITEMIZATION, USE THE FOLLOWING FORMAT				
	28. QUANTITY	29. ARTICLE NAME	30. BRAND NAME	31. SERIAL NUMBER	32. CODE
					S R <input type="checkbox"/> <input type="checkbox"/>
					S R <input type="checkbox"/> <input type="checkbox"/>
					S R <input type="checkbox"/> <input type="checkbox"/>
					S R <input type="checkbox"/> <input type="checkbox"/>
					S R <input type="checkbox"/> <input type="checkbox"/>

33. PROPERTY DAMAGE AMOUNT \$ _____

34. INSURANCE COMPANY _____

35. OFFICER ASSAULTED Y N

36. ARSON Y N

37. STRUCTURE CODE _____

38. DAMAGE \$ _____

47. CIB
 ENTERED CANCELLED
 NCIC
 OTHER BROADCAST

48. TOTAL AMOUNT PROPERTY STOLEN \$ _____

49. TOTAL AMOUNT PROPERTY RECOVERED \$ _____

50. IS REPORT CONTINUED? YES NO

51. CAUTION INDICATORS, ATLS ETC.

52. DATA PROCESS INFORMATION:

COMPUTER ENTERED DATE 16 20 99
 MICROFILM INDEXED INITIAL RS

53. FILE APPROVAL

IS CASE CLASSIFICATION CORRECT?
 IF N HAS CORRECTION BEEN MADE? Y N

BY [Signature] DATE 04/20/99

IMPORTANT MESSAGE

FOR Lt. Bushman
 DATE 04-22-99 TIME 0830 A.M. P.M.
 BY Anderson
 OF Sawyer Co.
 PHONE 715 [REDACTED]
AREA CODE NUMBER EXTENSION
 FAX
 MOBILE
AREA CODE NUMBER TIME TO CALL

TELEPHONED	<input checked="" type="checkbox"/>	PLEASE CALL	
CAME TO SEE YOU		WILL CALL AGAIN	
WANTS TO SEE YOU		RUSH	
RETURNED YOUR CALL		SPECIAL ATTENTION	

MESSAGE V 6474 T / Veh. which you reg. he check on has been in the garage all winter as well as plate(s); he knows the vehicle owner & does not feel plates were removed, nor placed on a diff. veh. Any further ?'s please call!
 SIGNED Dawn B.

TOPS FORM 3002P LITHO IN U.S.A.

IMPORTANT MESSAGE

FOR Lt Bushman
 DATE 3/21 TIME 0800 A.M. P.M.
 M Sabin
 OF Sawyer Co Sheriff
 PHONE 715 [REDACTED]
AREA CODE NUMBER EXTENSION
 FAX
 MOBILE
AREA CODE NUMBER TIME TO CALL

TELEPHONED	<input checked="" type="checkbox"/>	PLEASE CALL	
CAME TO SEE YOU		WILL CALL AGAIN	
WANTS TO SEE YOU		RUSH	
RETURNED YOUR CALL		SPECIAL ATTENTION	

MESSAGE see follow-up
h&R
 SIGNED PO

TOPS FORM 3002P

CALUMET COUNTY SHERIFF'S DEPARTMENT

206 Court Street
Chillicothe, MO 65014
(920) - 24 hours

Oscar E. Beilke, Sheriff

Paul A. Rusch, Captain

Appleton - [REDACTED]

Radio Station KGL 593
WI Teletype Code CASO
Fax: [REDACTED]

Monday - Friday
8:00 a.m. - 12:00 noon
1:00 p.m. - 4:30 p.m.

DATE: 04/04/99

TO: Manitowoc Co. Sher. Off's Dept

FROM: Calumet Co. Sher. Off's Dept

No. of sheets including cover sheet 2

CONFIDENTIALITY NOTICE

This message is intended only for the use of the individual or entity to which it is addressed and may contain information that is privileged, confidential, and exempt from disclosure under applicable law. If the reader of this message is not the intended recipient or the employee or agent responsible for delivering the message to the intended recipient, you are hereby notified that any dissemination, distribution, or copying of this communication is strictly prohibited. If you have received this communication in error, please notify us immediately by telephone and return the original message to us at the above address via the U.S. Postal Service. Thank you.

FAX/TXTSHERI



CRIME STOPPERS:

CODE #: 31

DATE: 4/4/99

TIME: 9:20 AM

TYPE OF CRIME: V64 74 T/CV @ Kwik Trip R.H.

Blazer white/blue trim - grill damage

AGENCY: MTSO

Forward a copy to Sgt. Dederling

Inform the subject to contact Sgt. Dederling back after thirty days. Also provide the caller with the code number and inform them when calling to use the code number.

Code # 31

1. CASE # S99-02746
 2. CLASSIFICATION 630.1
 3. CENSUS 14011

4. INCIDENT CS/S99 00242

5. INCIDENT LOCATION ANON

6. NAME - LAST - FIRST - MI
 7. D.O.B.

8. ADDRESS
 9. TX-HOME

11. CITY STATE ZIP
 10. TX-BUSINESS

12. DETAILS
 SEE ATTACHED FORM

04-07-99
1400

14. REC'D	15. DISP	16. 10-23	17. 10-24
13. DAY			
SUN 1	THU 5		
MON 2	FRI 6		
TUE 3	SAT 7		
WED 4			

MANITOWOC COUNTY SHERIFF
INCIDENT CARD

18. ASSIGNED
 MTSO 9 2 9

BUSHMAN 4 4 1

19. REC. BY 20. DIS. BY
 926

21. HOW REC'D.
 1. 911
 2. POLICE RADIO
 3. PHONE
 4. TTY
 5. IN PERSON
 6. ON VIEW
 7. OFF. OFF DUTY
 8. C.B. RADIO
 9. OTHER

22. TYPE OF REPORT
 1. INCIDENT
 2. ACCIDENT
 3. CITATION
 4. NONE

23. STATUS
 1. UNFOUNDED
 2. PNL
 3. OTHER
 4. CLEARED
 5. EXCEPT CLEARED

24. DATE CLEARED 05/17/99

25. OFFENSE TYPE
 1. ADULT NA
 2. JUVENILE
 3. UNKNOWN

21A. M.O.

39. (CODE S-SUSPECT W-WITNESS V-VICTIM O-OTHER)

CODE	40. NAME-LAST	FIRST	MI	41. D.O.B.	42. ADDRESS	43. TELEPHONE

Followup has been completed and added to S99-00242 on pages 82 through 87. Close out.
 M.J. Bushman

45. IF COMPLAINANT DIFFERENT THEN CALLER, ENTER NAME, ADDRESS, D.O.B., TELEPHONE.

46. IF CODE O (OTHER) IS USED IN FIELD #39, EXPLAIN.

INCIDENT REPORT: NOTE: IF SECTION 22 ABOVE HAS NUMBER 4 CHECKED, DO NOT GO BEYOND THIS LINE WITHOUT RECORDS SECTION BEING ADVISED, OR NO RECORD ENTRIES WILL BE MADE BELOW THIS LINE.

PROPERTY VALUE	26. PROPERTY	A. CURRENCY	B. JEWELRY	C. FURS CLOTHING	D. VEHICLE (LOCAL)	E. OFFICE EQUIPMENT	F. RADIO, TV CAMERAS	G. FIREARMS	H. HOUSE-HOLD GOODS
	STOLEN	\$	\$	\$	\$	\$	\$	\$	\$
	RECOVERED	\$	\$	\$	\$	\$	\$	\$	\$
	26. PROPERTY	I. CONSUMABLES	J. LIVESTOCK	K. DRUGS	L. MARINE ITEMS	M. CONSTRUCTION ITEMS	N. LAWN AND GARDEN	O. SPORTING GOODS	P. MISC BICYCLE
	STOLEN	\$	\$	\$	\$	\$	\$	\$	\$
	RECOVERED	\$	\$	\$	\$	\$	\$	\$	\$

27. PROPERTY RECOVERED: LOCALLY _____ OTHER JURISDICTION _____ (INSERT O OR L)

PROPERTY ITEMIZATION	PROPERTY STOLEN/RECOVERED ITEMIZATION, USE THE FOLLOWING FORMAT				
	28. QUANTITY	29. ARTICLE NAME	30. BRAND NAME	31. SERIAL NUMBER	32. CODE
					S R <input type="checkbox"/> <input type="checkbox"/>
					S R <input type="checkbox"/> <input type="checkbox"/>
					S R <input type="checkbox"/> <input type="checkbox"/>
					S R <input type="checkbox"/> <input type="checkbox"/>
					S R <input type="checkbox"/> <input type="checkbox"/>

33. PROPERTY DAMAGE AMOUNT \$ _____ 34. INSURANCE COMPANY _____

35. OFFICER ASSAULTED Y N 36. ARSON Y N 37. STRUCTURE CODE _____ 38. DAMAGE \$ _____

47. CIB ENTERED CANCELLED
 NCIC
 OTHER BROADCAST

48. TOTAL AMOUNT PROPERTY STOLEN \$ _____

49. TOTAL AMOUNT PROPERTY RECOVERED \$ _____

50. IS REPORT CONTINUED? YES NO

51. CAUTION INDICATORS, ATLS ETC.

52. DATA PROCESS INFORMATION:
 COMPUTER ENTERED DATE 16/09/99
 MICROFILM INDEXED INITIAL RS

53. FILE APPROVAL

IS CASE CLASSIFICATION CORRECT? Y N
 IF N HAS CORRECTION BEEN MADE? Y N

BY _____ DATE

1. CASE # 599-02762 | 2. CLASSIFICATION 630.11 | 3. CENSUS 7,000.0

4. INCIDENT CS-599-00242

5. INCIDENT LOCATION Brillion

6. NAME - FIRST-MI Brillion P.D. (6909) | 7. D.O.B.

8. PHOTO  | 9. TX-HOME

11. CITY STATE ZIP | 10. TX-BUSINESS

12. DETAILS
 LT Bushman req. CS report started and fax from Brillion P.D. attached to it.

2342
4-7-99

MANITOWOC COUNTY SHERIFF INCIDENT CARD

18. ASSIGNED Lt. Bushman 441

19. REC. BY 9-14 | 20. DIS. BY

21. HOW REC'D.
 1. 911
 2. POLICE RADIO
 3. PHONE
 4. TTY
 5. IN PERSON
 6. ON VIEW
 7. OFF. OFF DUTY
 8. C.B. RADIO
 9. OTHER

22. TYPE OF REPORT
 1. INCIDENT
 2. ACCIDENT
 3. CITATION
 4. NONE

23. STATUS
 1. UNFOUNDED
 2. PNL
 3. OTHER
 4. CLEARED
 5. EXCEPT CLEARED

24. DATE CLEARED 04/20/99

25. OFFENSE TYPE
 1. ADULT NA
 2. JUVENILE
 3. UNKNOWN

14. REC'D. | 15. DISP. | 16. 10-23 | 17. 10-24

13. DAY
 SUN 1 THU 5
 MON 2 FRI 6
 TUE 3 SAT 7
 WED 4

39. (CODE S-SUSPECT W-WITNESS V-VICTIM O-OTHER)	40. NAME-LAST	FIRST	MI	41. D.O.B.	42. ADDRESS	43. TELEPHONE
O	Fuhrmann, Andrew J.			11/4/78	178578 Oak St., Brillion	
O	Koehler, Karl J.			12/10/71	Long Lake Rd., Brillion	

04-07-99 @ 2210 hrs.: I, Lt. Bushman, received a phone call from Officer Muller, Brillion PD, ref. the hit & run veh. list that was passed onto Calumet County. Apparently he was checking some of the vehicles on the list and had the occasion to make contact with an ANDREW J. FUHRMANN ref. his 1986 Chevrolet Truck. FUHRMANN informed Officer Muller that his truck was burned in the Forest Junction area and he believed it was prior to the hit & run accident in Manitowoc. The truck is currently at the residence of KARL J. KOEHLER at Long Lake Rd. Officer Muller had been at the KOEHLER residence earlier in the day for another vehicle; however, no one was home. He made several other checks on vehicles in the Brillion area before he attempted to make contact at the Long Lake address. Upon arrival, ANDREW FUHRMANN was out there talking with KOEHLER which seemed to be unusual to Officer Muller. The 4-wheel truck chassis which had been burned was parked on the yard. The cab, front fenders, hood, and engine had been removed and KOEHLER was in the process of awaiting new parts to add to the truck. The frame and transfer box in front end had been painted and ready for reassembly. Most of the truck's parts were scattered along side the garage nearby.

It was at approx. this time, Officer Muller made contact with me at MTSO. I agreed to meet Officer Muller and accompany him back to the residence arriving at 2210 hrs. The veh. chassis, believed to be the 1986 Chevrolet previously owned by FUHRMANN, was parked in the driveway and had very large mud aggressive tires with aggressive tread and approx. 9" wide. The cab was extensively burnt, windshield was gone, as well as the grill & head light plastic assembly. I was able to view the hood and the radiator wall which although burnt and warped from the heat, did not appear to have sustained any impact type damage. I did not believe that this was the suspect veh.

Officer Muller then did some more follow up by contacting the deputy who went on the fire call when this veh. was burned. Deputy Brandenburg told Officer Muller that he did not see any damage on the veh. while it was burning; however, FUHRMANN had indicated to Officer Brandenburg that he had just completed redoing everything on the truck. The truck was plowing snow at the time of the fire and it was believed by the fire dept. that a gas line leak on the overheated engine is what caused it. There is no report in Calumet Co. Sheriff's Dept. on this fire, just an incident card. Officer Muller's report will be

599 04/20/99

1999-07 1080 601 60
 07000 APR 23

45. IF COMPLAINANT DIFFERENT THEN CALLER, ENTER NAME, ADDRESS, D.O.B., TELEPHONE.

46. IF CODE O (OTHER) IS USED IN FIELD #39, EXPLAIN.

INCIDENT REPORT: NOTE: IF SECTION 22 ABOVE HAS NUMBER 4 CHECKED, DO NOT GO BEYOND THIS LINE WITHOUT RECORDS SECTION BEING ADVISED, OR NO RECORD ENTRIES WILL BE MADE BELOW THIS LINE.

PROPERTY VALUE	26. PROPERTY	A. CURRENCY	B. JEWELRY	C. FURS CLOTHING	D. VEHICLE (LOCAL)	E. OFFICE EQUIPMENT	F. RADIO, TV CAMERAS	G. FIREARMS	H. HOUSE-HOLD GOODS
	STOLEN	\$	\$	\$	\$	\$	\$	\$	\$
	RECOVERED	\$	\$	\$	\$	\$	\$	\$	\$
	26. PROPERTY	I. CONSUMABLES	J. LIVESTOCK	K. DRUGS	L. MARINE ITEMS	M. CONSTRUCTION ITEMS	N. LAWN AND GARDEN	O. SPORTING GOODS	P. MISC BICYCLE
STOLEN	\$	\$	\$	\$	\$	\$	\$	\$	
RECOVERED	\$	\$	\$	\$	\$	\$	\$	\$	

27. PROPERTY RECOVERED: LOCALLY ____ OTHER JURISDICTION ____ (INSERT O OR L)

PROPERTY ITEMIZATION	PROPERTY STOLEN/RECOVERED ITEMIZATION, USE THE FOLLOWING FORMAT				
	28. QUANTITY	29. ARTICLE NAME	30. BRAND NAME	31. SERIAL NUMBER	32. CODE
					S R <input type="checkbox"/> <input type="checkbox"/>
					S R <input type="checkbox"/> <input type="checkbox"/>
					S R <input type="checkbox"/> <input type="checkbox"/>
					S R <input type="checkbox"/> <input type="checkbox"/>
					S R <input type="checkbox"/> <input type="checkbox"/>

33. PROPERTY DAMAGE AMOUNT \$ _____

34. INSURANCE COMPANY _____

35. OFFICER ASSAULTED Y N

36. ARSON Y N

37. STRUCTURE CODE _____

38. DAMAGE \$ _____

47. CIB ENTERED CANCELLED
 NCIC
 OTHER BROADCAST

48. TOTAL AMOUNT PROPERTY STOLEN \$ _____

49. TOTAL AMOUNT PROPERTY RECOVERED \$ _____

50. IS REPORT CONTINUED? YES NO

51. CAUTION INDICATORS, ATLS ETC.

52. DATA PROCESS INFORMATION:

COMPUTER ENTERED DATE 16 09 99

MICROFILM INDEXED INITIAL KS

IS CASE CLASSIFICATION CORRECT? N
 IF N HAS CORRECTION BEEN MADE? N

53. FILE APPROVAL

BY  DATE 042099

MANITOWOC COUNTY SHERIFF'S DEPARTMENT
FOLLOW-UP REPORT

Page: 2

CASE NUMBER: S99-02762 CLASSIFICATION: _____

INCIDENT: _____

DATE AND TIME: _____

REPORT CONTINUED:

attached to this complaint and this incident can be closed out. MJBushman *[Signature]* klf

1. CASE # S99 No 02785	2. CLASSIFICATION 6,3 0,1 	3. CENSUS 5,2 000
4. INCIDENT CS S99-00242		
5. INCIDENT LOCATION 200 block North 8th		
6. NAME - LAST - FIRST - MI Manitowoc PD		7. D.O.B.
8. ADDRESS		9. TX-HOME
11. CITY	STATE ZIP	10. TX-BUSINESS
12. DETAILS Off. Reimer checked the vehicle listed below while working patrol, and can be eliminated as a suspect vehicle.		

12 04 99 0024HR

MANITOWOC COUNTY SHERIFF INCIDENT CARD		
18. ASSIGNED CCW		
19. REC. BY [Signature]		20. DIS. BY [Signature]
21. HOW REC'D. 1. 911 2. POLICE RADIO 3. PHONE 4. TTY 5. IN PERSON 6. ON VIEW 7. OFF. OFF DUTY 8. C.B. RADIO 9. OTHER		22. TYPE OF REPORT 1. INCIDENT 2. ACCIDENT 3. CITATION 4. NONE
14. REC'D 15. DISP 16. 10-23 17. 10-24		23. STATUS 1. UNFOUNDED 2. PNL 3. OTHER 4. CLEARED 5. EXCEPT CLEARED
13. DAY SUN 1 THU 5 MON 3 FRI 6 TUE 3 SAT 7 WED 4		24. DATE CLEARED 04/05/89
21A. M.O.		25. OFFENSE TYPE 1. ADULT <input type="checkbox"/> NA <input type="checkbox"/> 2. JUVENILE <input type="checkbox"/> 3. UNKNOWN <input type="checkbox"/>

NOV 1989

39. (CODE S-SUSPECT W-WITNESS V-VICTIM O-OTHER)	40. NAME-LAST	FIRST	MI	41. D.O.B.	42. ADDRESS	43. TELEPHONE
O	Muck, Duane E.	31138			Clark St., Mtwc	

04/05/99 0024hrs 83 Chev registration AB70457 was parked in the 200 block of 8th st, Mtwc. 065 Reimer reported no damage to the chrome bumper or hood. There was some minor damage to the passenger side grill. Vehicle is red/silver not believed to be suspect vehicle, close out and enter in FBI file. M.J. Bushman

S99 No 02785

45. IF COMPLAINANT DIFFERENT THEN CALLER, ENTER NAME, ADDRESS, D.O.B., TELEPHONE.

46. IF CODE O (OTHER) IS USED IN FIELD #39, EXPLAIN.

INCIDENT REPORT: NOTE: IF SECTION 22 ABOVE HAS NUMBER 4 CHECKED, DO NOT GO BEYOND THIS LINE WITHOUT RECORDS SECTION BEING ADVISED, OR NO RECORD ENTRIES WILL BE MADE BELOW THIS LINE.

PROPERTY VALUE	26. PROPERTY	A. CURRENCY	B. JEWELRY	C. FURS CLOTHING	D. VEHICLE (LOCAL)	E. OFFICE EQUIPMENT	F. RADIO, TV CAMERAS	G. FIREARMS	H. HOUSE-HOLD GOODS
	STOLEN	\$	\$	\$	\$	\$	\$	\$	\$
	RECOVERED	\$	\$	\$	\$	\$	\$	\$	\$
	26. PROPERTY	I. CONSUMABLES	J. LIVESTOCK	K. DRUGS	L. MARINE ITEMS	M. CONSTRUCTION ITEMS	N. LAWN AND GARDEN	O. SPORTING GOODS	P. MISC BICYCLE
STOLEN	\$	\$	\$	\$	\$	\$	\$	\$	
RECOVERED	\$	\$	\$	\$	\$	\$	\$	\$	

27. PROPERTY RECOVERED: LOCALLY _____ OTHER JURISDICTION _____ (INSERT O OR L)

PROPERTY ITEMIZATION	PROPERTY STOLEN/RECOVERED ITEMIZATION, USE THE FOLLOWING FORMAT			
	28. QUANTITY	29. ARTICLE NAME	30. BRAND NAME	31. SERIAL NUMBER
				32. CODE S <input type="checkbox"/> R <input type="checkbox"/>
				S <input type="checkbox"/> R <input type="checkbox"/>
				S <input type="checkbox"/> R <input type="checkbox"/>
				S <input type="checkbox"/> R <input type="checkbox"/>
				S <input type="checkbox"/> R <input type="checkbox"/>
				S <input type="checkbox"/> R <input type="checkbox"/>

33. PROPERTY DAMAGE AMOUNT \$ _____

34. INSURANCE COMPANY _____

35. OFFICER ASSAULTED Y N

36. ARSON Y N

37. STRUCTURE CODE _____

38. DAMAGE \$ _____

47. CIB ENTERED CANCELLED
 NCIC
 OTHER BROADCAST

48. TOTAL AMOUNT PROPERTY STOLEN \$ _____

49. TOTAL AMOUNT PROPERTY RECOVERED \$ _____

50. IS REPORT CONTINUED? YES NO

51. CAUTION INDICATORS, ATLS ETC.

52. DATA PROCESS INFORMATION:

COMPUTER ENTERED DATE 10/29/99

MICROFILM INDEXED INITIAL JS

IS CASE CLASSIFICATION CORRECT?
 IF N HAS CORRECTION BEEN MADE?

Y N

53. FILE APPROVAL

BY *JMF*

DATE 04/20/99

1. CASE # **S99 No 02834** 2. CLASSIFICATION **630.11** 3. CENSUS **310.00**

4. INCIDENT **CS 599-00242**

5. INCIDENT LOCATION **CLEVELAND BONDE'S STATION**

6. NAME - LAST-FIRST-MI [REDACTED] 7. D.O.B. [REDACTED]

8. ADDRESS [REDACTED] 9. TX-HOME [REDACTED]

11. CITY [REDACTED] STATE [REDACTED] ZIP [REDACTED] 10. TX-BUSINESS [REDACTED]

12. DETAILS
**COMP. STATES SEEING THIS
 VEH. AT ABOVE LOCATION THIS
 MORNING. GRILL & DRIVER
 SIDE DAMAGE BC 48104**

04-10-99 1955

14. REC'D [REDACTED] 15. DISP [REDACTED] 16. 10-23 [REDACTED] 17. 10-24 [REDACTED]

13. DAY
 SUN 1 THU 5
 MON 2 FRI 6
 TUE 3 SAT 7
 WED 4

**MANITOWOC COUNTY SHERIFF
 INCIDENT CARD**

18. ASSIGNED **MISO 92A**

19. REC. BY **9416** 20. DIS. BY [REDACTED]

21. HOW REC'D.
 1. 911
 2. POLICE RADIO
 3. PHONE
 4. TTY
 5. IN PERSON
 6. ON VIEW
 7. OFF. OFF DUTY
 8. C.B. RADIO
 9. OTHER

22. TYPE OF REPORT
 1. INCIDENT
 2. ACCIDENT
 3. CITATION
 4. NONE

23. STATUS
 1. UNFOUNDED
 2. PNL
 3. OTHER
 4. CLEARED
 5. EXCEPT CLEARED

24. DATE CLEARED **10/01/99**

25. OFFENSE TYPE
 1. ADULT NA
 2. JUVENILE
 3. UNKNOWN

21A. M.O. [REDACTED]

39. (CODE S-SUSPECT W-WITNESS V-VICTIM O-OTHER)	40. NAME-LAST	FIRST	MI	41. D.O.B.	42. ADDRESS	43. TELEPHONE
O	DIDIER	FRANK	A	[REDACTED]	Green Bay Rd. Port Washington	[REDACTED]
O	DEIDER	EARL	B	[REDACTED]	N 41st St. Milwaukee	[REDACTED]
S	Muchka Jr, David R.			[REDACTED]	N. 77th St. Milwaukee	[REDACTED]
S	Muchka Sr. David			[REDACTED]	N 77th St. Milwaukee	[REDACTED]
W	Bulckaen Emile E. Jr.			[REDACTED]	N. 77th St. Milwaukee	[REDACTED]

04/16/99 Vehicle description in complaint does not match, attempted contact and complainant was gone to bed as he gets up early for work, after 2PM Saturday is a good time to call. M.J. Bushman

04-26-99 @ 2200 hrs.: Contact was made by phone with a FRANK A. DIDIER who stated the 1977 Chevrolet truck in question had been sold approx. 1 1/2 years ago. It would have been brown & beige in color, there was damage, it was just rusty. It also had a cap with a deer scene on it. The pickup truck would be a short box 2-wheel drive version. FRANK DIDIER did not recall the exact date that he sold the truck, but he had sold it to a party that he works with, with a nickname of ARROW at the SCHMIDT BROS FORD DEALERSHIP in Fort Washington. ARROW works in the Parts Dept. There phone # is [REDACTED].

04-29-99 @ 1400 hrs.: Contact was made by phone with EARL D. DEIDER (ARROW) while he was at work in Port Washington. He stated that he bought the truck from DIDIER, fixed it up, and resold it. He thought sometime after Christmas, possibly around February is when he sold it. He described the veh. as a 2-tone beige & brown, 2-wheel drive, short box. He sold the truck to a party who lives in Milwaukee, first name of DAVID, phone # [REDACTED]

1420 hrs.: I, Lt. Bushman, called the number provided by EARL DEIDER and a female answered the phone. I asked for DAVE and she hung up the phone. I called back a short time, asked for DAVE and she hung up the phone again.

2030 hrs.: Contact was attempted again, and this time got a hold of DAVE. He was extremely evasive about answering any questions, described the veh. the same as the prior two owners; however, gave me a RP# AM11735 99. He stated the veh. belongs to his son, DAVID JR., and the transmission has been out on it since December. He then went on to explain that every time they got snow this year, he knows for a fact that it's been parked in his yard because he had to blow snow around it. He said the tires are bald, absolutely no good with any type of slippery roads. He would not provide his last name, address, and the registration he gave me does not come back to that veh., it comes back to a party out of Pembine, WI He then suggested I talk to his attorney, MR. MARTY KOHLER, and gave me a

4-C 0-7-N 666

000012 Inval 11/91

45. IF COMPLAINANT DIFFERENT THEN CALLER, ENTER NAME, ADDRESS, D.O.B., TELEPHONE.

46. IF CODE O (OTHER) IS USED IN FIELD #39, EXPLAIN.

INCIDENT REPORT: NOTE: IF SECTION 22 ABOVE HAS NUMBER 4 CHECKED, DO NOT GO BEYOND THIS LINE WITHOUT RECORDS SECTION BEING ADVISED, OR NO RECORD ENTRIES WILL BE MADE BELOW THIS LINE.

PROPERTY VALUE	26. PROPERTY	A. CURRENCY	B. JEWELRY	C. FURS CLOTHING	D. VEHICLE (LOCAL)	E. OFFICE EQUIPMENT	F. RADIO, TV CAMERAS	G. FIREARMS	H. HOUSE-HOLD GOODS
	STOLEN	\$	\$	\$	\$	\$	\$	\$	\$
	RECOVERED	\$	\$	\$	\$	\$	\$	\$	\$
	26. PROPERTY	I. CONSUMABLES	J. LIVESTOCK	K. DRUGS	L. MARINE ITEMS	M. CONSTRUCTION ITEMS	N. LAWN AND GARDEN	O. SPORTING GOODS	P. MISC BICYCLE
	STOLEN	\$	\$	\$	\$	\$	\$	\$	\$
	RECOVERED	\$	\$	\$	\$	\$	\$	\$	\$

27. PROPERTY RECOVERED: LOCALLY _____ OTHER JURISDICTION _____ (INSERT O OR L)

PROPERTY ITEMIZATION	PROPERTY STOLEN/RECOVERED ITEMIZATION, USE THE FOLLOWING FORMAT				
	28. QUANTITY	29. ARTICLE NAME	30. BRAND NAME	31. SERIAL NUMBER	32. CODE
					S R <input type="checkbox"/> <input type="checkbox"/>
					S R <input type="checkbox"/> <input type="checkbox"/>
					S R <input type="checkbox"/> <input type="checkbox"/>
					S R <input type="checkbox"/> <input type="checkbox"/>
					S R <input type="checkbox"/> <input type="checkbox"/>

33. PROPERTY DAMAGE AMOUNT \$ _____

34. INSURANCE COMPANY _____

35. OFFICER ASSAULTED Y N

36. ARSON Y N

37. STRUCTURE CODE _____

38. DAMAGE \$ _____

47. CIB ENTERED CANCELLED
 NCIC
 OTHER BROADCAST

48. TOTAL AMOUNT PROPERTY STOLEN \$ _____

49. TOTAL AMOUNT PROPERTY RECOVERED \$ _____

50. IS REPORT CONTINUED? YES NO

51. CAUTION INDICATORS, ATLS ETC.

52. DATA PROCESS INFORMATION:

COMPUTER ENTERED

DATE

10/29/99

MICROFILM INDEXED

INITIAL

AS

IS CASE CLASSIFICATION CORRECT?
 IF N HAS CORRECTION BEEN MADE?

Y N
 Y N

53. FILE APPROVAL

BY

[Signature]

DATE

10/01/99

MANITOWOC COUNTY SHERIFF'S DEPARTMENT
FOLLOW-UP REPORT

Page: 2

CASE NUMBER: S99-02834 CLASSIFICATION: _____

INCIDENT: _____

DATE AND TIME: _____

REPORT CONTINUED:

phone # of [REDACTED]. He stated if I convince MARTY KOHLER it's all right for him to have officers stop by and check the veh., he will then call me back. MJBushman/ klf

04/30/99 Contact made by phone with Atty Marty Kohler's office. Kohler was in court and I spoke with his associate who advised he would pass the information on to Marty Kohler after 1500hrs.

05/05/99 2100hrs Attempted contact with David again and got his wife on the phone. She asked who was calling and stated, "Our Attorney said he don't have to show you nothing." She then hung up after saying again David Sr. was not home.

Using the Internet Query "AnyWho" Sgt Hermann and I were able to locate a name, address, and map to David [REDACTED]. Suspect name and address used to obtain DOB through Milwaukee and Criminal history run. Suspect David R.Muchka, [REDACTED] No.77thSt.Milwaukee.

Contact remade with Earl D.Deider. He has not located a vin number from the previous owned vehicle. He did remember now that he had sold that truck much earlier than originally thought and that would have been in September or October 98. He did not locate a last name for David.

Deider sold the truck to David Jr. but also knows David Sr. I described the older male the complainant saw with the vehicle here in Manitowoc area. Deider stated it did not sold like David Sr. Deider recalls running into David Jr. in December 98 and David Jr. telling Deider the transmission had gone out on the truck he bought from Deider. Deider also had a conversation with Frank Didier at work. The two agreed that Earl removed the plates when he bought the truck and returned the plates to Frank, although neither party recalls what happened to the plates.

05/06/99 Query Vehicle From ORI Rhas. It was noted David R.Muchka owns an 86 Chev Trk, registration DISM163. Contact made with Dist 4 Milwaukee and spoke with Sgt.Mike Zarnick, reference coming to the neighborhood of [REDACTED] N 77th St.Milwaukee and rattle a few doors around the Muchka residence. Saturday afternoon would be good stop at Dist.4 for assistance.

05/08/99 1554hrs I, Lt.Bushman made contact at Dis.4 Milwaukee PD with Sgt.Michael Zarnick who was just starting the shift with rollcall. With Clearance from downtown HQ Sgt.Zarnick Offs Schad and Ziebell accompanied me to the neighborhood of [REDACTED] N.77th Street. I made contact with neighbor Emile E.Bulckaen and his neice at [REDACTED] next door neighbor. Together we walked his property to the rear corner where we were 5 Ft. from the suspect Brown Chev P/U single registration plate on front AM 11735. There was damage to the right front grille, however the missing pc's did not match the H&R parts at scene. There was no sheet metal damage. Rt. side tires were flat and veh. covered in dirt looked as if it had not been driven in a long time. While we stood by Mil.PD went to the door but got no response. Emmediate yard was checked for parts, nothing unusual noted. Tire tread no match. Veh. description as given by previous owners did match.

I learned from Emile that the Chev. had been parked since early December and he also knew the transmission was out. He has not seen the vehicle leave the yard since then. He was asked about the 86 Chev listed to Muchka. Emile stated that was Sr.'s vehicle, it is a Sub-urban (gray) kept in top condition. There is no damage nor was there any damage at any time this winter, he sees it every day coming or going. We talked briefly about Muchka's evasiveness and Emile stated there propably is warrant for David Sr. or Mark as both have extensive police contact, and Muchka believes MilWaukee PD railroaded their cousin on an armed robbery case. Cousin Bobby Underwood now in prison. Emile knew alot about his neighbors as he occassionally fishes with them. I showed him CrimeStopper poster picture. He stated he has not seen any other simular vehicle like that at Muchka's residence.

There is a [REDACTED] Barlow Lake Rd. Pembine address being checked in Marinette County by deputies another address for Muchka. Close out complaint pending positive findings in

STATEMENT

INCIDENT NO. _____

STATEMENT OF:

PAGE _____

NAME _____

DATE _____ TIME _____

D.O.B. _____ AGE _____

ADDRESS _____

CITY _____ STATE _____ ZIP _____

PHONE _____

FATHER _____ MOTHER _____

VEHICLES

77 CHEV P/U
86 CHEV ^{TRUCK}? DAMAGE / WH NISSAN PRISON GUARD DODGE
WAS 77 PARKED ACCIDENT? DAMAGE? RIG SUBURBAN / GRAY
AM 11-735

EMILE E. BULLCKAEN JR.

██████ N 27th ST.

BEFORE DEC

MILWAUKEE

██████████

GRAY GEAR IT RECALCULATED
LEFT UP V. WELL
GMC TRUCK
FISH I

BOBBY UNDERWOOD

WITT. _____ SIGNATURE _____

WITT. _____ TIME _____

Place _____

Date _____

Time _____

MIRANDA WARNING

YOU HAVE THE RIGHT TO REMAIN SILENT.

ANYTHING YOU SAY CAN AND WILL BE USED AGAINST YOU IN A COURT OF LAW.

YOU HAVE THE RIGHT TO CONSULT WITH A LAWYER BEFORE QUESTIONING AND TO HAVE A LAWYER PRESENT WITH YOU DURING YOUR QUESTIONING.

IF YOU CANNOT AFFORD TO HIRE A LAWYER, ONE WILL BE APPOINTED TO REPRESENT YOU AT PUBLIC EXPENSE BEFORE OR DURING ANY QUESTIONING, IF YOU SO WISH.

IF YOU DECIDE TO ANSWER QUESTIONS NOW WITHOUT A LAWYER PRESENT, YOU HAVE THE RIGHT TO STOP THE QUESTIONING AND REMAIN SILENT AT ANY TIME YOU WISH, AND THE RIGHT TO ASK FOR AND HAVE A LAWYER AT ANY TIME YOU WISH, INCLUDING DURING THE QUESTIONING.

Signed _____

* * * * *

WAIVER

DO YOU UNDERSTAND EACH OF THESE RIGHTS?

REALIZING THAT YOU HAVE THESE RIGHTS, ARE YOU NOW WILLING TO ANSWER QUESTIONS OR MAKE A STATEMENT?

Signed _____

Witness _____

Witness _____

Date _____

Query Result



- People
- Business
- Reverse Lookup
- Toll-Free
- Web Sites
- Add Listing
- Update Listing
- Link to Anywho
- Wish List
- Jobs
- 9¢ Long Distance
- Shopping Deals
- Click2DialSM
- Send Cards
- Flowers & Gifts

Query Result

MUCHKA DAVID
N 77th Street
Milwaukee, WI 53218



Your query matched 1 entry.

New Search

AT&T Personal Network

Finally, communications has caught up with the way you live.

Anywho Services

- ▶ Buy Factory-Direct at
- ▶ The Ultimate Sports Store
- ▶ The best prices at
- ▶ \$60 off a Sony boombox

Click on one of these services and enjoy shopping online!



Mapping by
Maps On Us™

[AnyWho Home](#) | [Help](#) | [Privacy](#) | [About Us](#) | [Jobs](#)
[The AnyWho Advantage](#) | [Directory Standards](#) | [Advertise with Us](#)

Use of this site signifies your agreement to the [terms of use](#).
See our [privacy policy](#).
ANYWHO is a service mark of AT&T.

Can't Find Them?

- MAPS
- Current Map
- ROUTES
- YELLOW PAGES
- ADDRESS BOOK
- TOOLS
- SWITCHBOARD SERVICES
- HELP FAQ CONTACT US

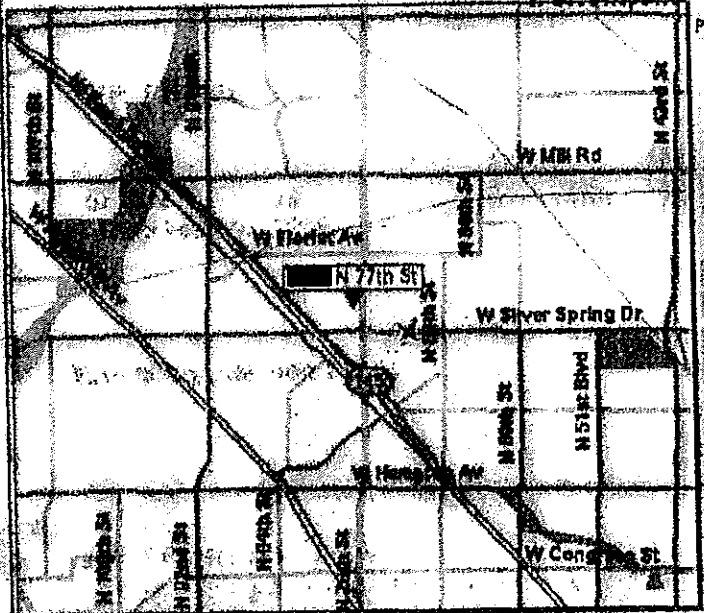

PAN BY:

FULL SCREEN

HALF SCREEN

ZOOM FAR IN

ZOOM IN

ZOOM OUT

ZOOM FAR OUT

BLACKWHITE

ERASE LABELS

MORE DETAIL

0.70 8718 N 77TH STREET, MILWAUKEE, WI 53218

Map data copyright Etak, Inc. 1984-1999. All rights reserved. Use subject to

Scale (mi/in): 0.70 Map-Clicking will: Zoom In

REDRAW MAP

4th Dist W Silver Spring



05/05/1999 22:43:25 EDT

Map On Us
the people and business directory

For questions or comments, please see our page or

Map data copyright Etak, Inc. 1984-1999; use subject to

1. CASE # S99 No 02855 | 2. CLASSIFICATION 6310.1 | 3. CENSUS 52100.0

4. INCIDENT # *See S99-00242*

5. INCIDENT LOCATION
 NAME- LAST - FIRST - MI [REDACTED] (23678) | 7. D.O.B. [REDACTED]

8. ADDRESS [REDACTED] | 9. TX-HOME [REDACTED]

11. CITY [REDACTED] STATE [REDACTED] ZIP [REDACTED] | 10. TX-BUSINESS [REDACTED]

12. DETAILS
 COMPL SOLD AN '86 SUBURBAN
 IN SEPT OF '97. UNKN. IF SAME
 HAS BEEN CHECKED BY AUTHORITIES.
 SEE ATTACHED.

MANITOWOC COUNTY SHERIFF
INCIDENT CARD

18. ASSIGNED
 MTS J | 929

19. REC. BY 930 | 20. DIS. BY 930

21. HOW REC'D.
 1. 911
 2. POLICE RADIO
 3. PHONE
 4. TTY
 5. IN PERSON
 6. ON VIEW
 7. OFF. OFF DUTY
 8. C.B. RADIO
 9. OTHER

22. TYPE OF REPORT
 1. INCIDENT
 2. ACCIDENT
 3. CITATION
 4. NONE

23. STATUS
 1. UNFOUNDED
 2. PNL
 3. OTHER
 4. CLEARED
 5. EXCEPT CLEARED

24. DATE CLEARED 04/25/99

25. OFFENSE TYPE
 1. ADULT NA
 2. JUVENILE
 3. UNKNOWN

13. DAY
 SUN 1 THU 5
 MON 2 FRI 6
 TUE 3 SAT 7
 WED 4

1130 04-11-99

39. (CODE S-SUSPECT W-WITNESS V-VICTIM O-OTHER)							
CODE	40. NAME-LAST	FIRST	MI	41. D.O.B.	42. ADDRESS	43. TELEPHONE	
0	Anderson	Andrew R.		[REDACTED]	Woodview Ln. Two Rivers	[REDACTED]	

04/19/99 0035hrs Officer scanned the neighborhood on Woodview Lane and observed the second residence West of STH 147 had a GMC Suburban, 2 Ford vans, and 2 Jeep 4WD. There were more vehicles parked out back out of good sight range. Registration on the Suburban was NRG 737 listing to Andrew Anderson. There was some damage noted to the grill and bumper between center emblem and right front (passenger) headlamp. Few lights were on in the residence and contact was not made.

2116 hrs Contact made with Andrew Anderson. Officer stated his business and Anderson stated "I bought the Suburban in September 1997 from a guy in Manitowoc. The damage to the front happened three weeks ago at the PBI store in Manitowoc."

We walked outside to the vehicle. I observed a small amount of damage to the grill and a rounded impact point on the bumper with yellow foreign paint. Andersen stated he was distracted while driving in a parking lot and struck a concrete yellow marker. City PD should have a report.

Anderson stated he had no other similar Chev or GMC vehicles. This is not the hit&run vehicle as it does not fit the description. Close Out. M.J. Bushman

City Complaint # M99-01656

04/28/99 4:17 Glaeser entered info from this report onto computer program 0545 hrs. EJC *ETC*

CASE # S99 No 02855

45. IF COMPLAINANT DIFFERENT THEN CALLER, ENTER NAME, ADDRESS, D.O.B., TELEPHONE.

46. IF CODE O (OTHER) IS USED IN FIELD #39, EXPLAIN.

INCIDENT REPORT: NOTE: IF SECTION 22 ABOVE HAS NUMBER 4 CHECKED, DO NOT GO BEYOND THIS LINE WITHOUT RECORDS SECTION BEING ADVISED, OR NO RECORD ENTRIES WILL BE MADE BELOW THIS LINE.

PROPERTY VALUE	26. PROPERTY	A. CURRENCY	B. JEWELRY	C. FURS CLOTHING	D. VEHICLE (LOCAL)	E. OFFICE EQUIPMENT	F. RADIO, TV CAMERAS	G. FIREARMS	H. HOUSE-HOLD GOODS
	STOLEN	\$	\$	\$	\$	\$	\$	\$	\$
	RECOVERED	\$	\$	\$	\$	\$	\$	\$	\$
	26. PROPERTY	I. CONSUMABLES	J. LIVESTOCK	K. DRUGS	L. MARINE ITEMS	M. CONSTRUCTION ITEMS	N. LAWN AND GARDEN	O. SPORTING GOODS	P. MISC BICYCLE
STOLEN	\$	\$	\$	\$	\$	\$	\$	\$	
RECOVERED	\$	\$	\$	\$	\$	\$	\$	\$	

27. PROPERTY RECOVERED: LOCALLY _____ OTHER JURISDICTION _____ (INSERT O OR L)

PROPERTY ITEMIZATION	PROPERTY STOLEN/RECOVERED ITEMIZATION, USE THE FOLLOWING FORMAT			
	28. QUANTITY	29. ARTICLE NAME	30. BRAND NAME	31. SERIAL NUMBER
				32. CODE S R <input type="checkbox"/> <input type="checkbox"/>
				S R <input type="checkbox"/> <input type="checkbox"/>
				S R <input type="checkbox"/> <input type="checkbox"/>
				S R <input type="checkbox"/> <input type="checkbox"/>
				S R <input type="checkbox"/> <input type="checkbox"/>
				S R <input type="checkbox"/> <input type="checkbox"/>

33. PROPERTY DAMAGE AMOUNT \$ _____

34. INSURANCE COMPANY _____

35. OFFICER ASSAULTED Y N

36. ARSON Y N

37. STRUCTURE CODE _____

38. DAMAGE \$ _____

47. CIB ENTERED CANCELLED
 NCIC
 OTHER BROADCAST

48. TOTAL AMOUNT PROPERTY STOLEN \$ _____

49. TOTAL AMOUNT PROPERTY RECOVERED \$ _____

50. IS REPORT CONTINUED? YES NO

51. CAUTION INDICATORS, ATLS ETC.

52. DATA PROCESS INFORMATION:

COMPUTER ENTERED DATE 6/29/99
 MICROFILM INDEXED INITIAL AS

IS CASE CLASSIFICATION CORRECT?
 IF N HAS CORRECTION BEEN MADE?

Y N

53. FILE APPROVAL

BY [Signature]

DATE 04/28/99

1. CASE # S99 No 02858 2. CLASSIFICATION 6,310,11 3. CENSUS 7,010,00

4. INCIDENT CS/S99-00242

5. LOCATION 151 FOND DU LAC COUNTY

6. NAME- LAST-FIRST MI [REDACTED] 7. D.O.B. [REDACTED]

8. ADDRESS [REDACTED] 9. TX-HOME [REDACTED]

11. CITY [REDACTED] STATE [REDACTED] ZIP [REDACTED] 10. TX-BUSINESS [REDACTED]

12. CALLER WAS DRIVING HOME FROM FOND DU LAC & NOTICED TRUCK IN REARVIEW MIRROR WITH DAMAGE TO GRILL, BUMPER AREA. IT WAS A

1802
4-11-99

14. REC'D # 15. DISP 16. 10-23 17. 10-24
13. DAY
SUN 1 THU 5
MON 2 FRI 6
TUE 3 SAT 7
WED 4

MANITOWOC COUNTY SHERIFF INCIDENT CARD

18. ASSIGNED
MISO 9129
M. Bushman HHI

19. REC. BY 932 20. DIS. BY
22. TYPE OF REPORT
1. INCIDENT
2. ACCIDENT
3. CITATION
4. NONE

21. HOW REC'D.
1. 911
2. POLICE RADIO
3. PHONE
4. TTY
5. IN PERSON
6. ON VIEW
7. OFF. OFF DUTY
8. C.B. RADIO
9. OTHER

23. STATUS
1. UNFOUNDED
2. PNL
3. OTHER
4. CLEARED
5. EXCEPT CLEARED
24. DATE CLEARED 5/17/00
25. OFFENSE TYPE
1. ADULT NA
2. JUVENILE
3. UNKNOWN

39. (CODE S-SUSPECT W-WITNESS V-VICTIM O-OTHER)				42. ADDRESS		43. TELEPHONE
CODE	40. NAME-LAST	FIRST	MI	41. D.O.B.		
O	McCarthy, Patrick H.				Schumacher Rd., Malone	[REDACTED]
	Fond Du Lac Sheriff					FAX [REDACTED]

gold or yellow colored Chev pick up truck with personalized RP# MCARTHY. This truck was behind caller's vehicle from city of Fond du Lac EB almost to Calumet County line when it turned off. Plate came back registered to a party from Malone, WI, which is in the northern part of Fond du Lac County. 932/mh
04/26/99 Fond Du Lac Sheriff Dept. requested to assist. Phone contact made and fax number for dispatching received. Please check vehicle and obtain explanation of damage. Forward copy of report back to MISO Fax [REDACTED]. Description below, Thanks, M.J. Bushman.
05/13/99 Advised to call back during the day, unable to locate report, no entry made under McCarthy's name since 1988. M.J. Bushman

S99 No 02858

45. IF COMPLAINANT DIFFERENT THEN CALLER, ENTER NAME, ADDRESS, D.O.B., TELEPHONE.

46. IF CODE O (OTHER) IS USED IN FIELD #39, EXPLAIN.

INCIDENT REPORT: NOTE: IF SECTION 22 ABOVE HAS NUMBER 4 CHECKED, DO NOT GO BEYOND THIS LINE WITHOUT RECORDS SECTION BEING ADVISED, OR NO RECORD ENTRIES WILL BE MADE BELOW THIS LINE.

PROPERTY VALUE	26. PROPERTY	A. CURRENCY	B. JEWELRY	C. FURS CLOTHING	D. VEHICLE (LOCAL)	E. OFFICE EQUIPMENT	F. RADIO, TV CAMERAS	G. FIREARMS	H. HOUSE-HOLD GOODS
	STOLEN	\$	\$	\$	\$	\$	\$	\$	\$
	RECOVERED	\$	\$	\$	\$	\$	\$	\$	\$
	26. PROPERTY	I. CONSUMABLES	J. LIVESTOCK	K. DRUGS	L. MARINE ITEMS	M. CONSTRUCTION ITEMS	N. LAWN AND GARDEN	O. SPORTING GOODS	P. MISC BICYCLE
	STOLEN	\$	\$	\$	\$	\$	\$	\$	\$
	RECOVERED	\$	\$	\$	\$	\$	\$	\$	\$

27. PROPERTY RECOVERED: LOCALLY ____ OTHER JURISDICTION ____ (INSERT O OR L)

PROPERTY ITEMIZATION	PROPERTY STOLEN/RECOVERED ITEMIZATION, USE THE FOLLOWING FORMAT				
	28. QUANTITY	29. ARTICLE NAME	30. BRAND NAME	31. SERIAL NUMBER	
					S <input type="checkbox"/> R <input type="checkbox"/>
					S <input type="checkbox"/> R <input type="checkbox"/>
					S <input type="checkbox"/> R <input type="checkbox"/>
					S <input type="checkbox"/> R <input type="checkbox"/>
					S <input type="checkbox"/> R <input type="checkbox"/>

33. PROPERTY DAMAGE AMOUNT \$ _____ 34. INSURANCE COMPANY _____

35. OFFICER ASSAULTED Y N 36. ARSON Y N 37. STRUCTURE CODE _____ 38. DAMAGE \$ _____

47. CIB ENTERED CANCELLED
 NCIC
 OTHER BROADCAST

48. TOTAL AMOUNT PROPERTY STOLEN \$ _____

49. TOTAL AMOUNT PROPERTY RECOVERED \$ _____

50. IS REPORT CONTINUED? YES NO

51. CAUTION INDICATORS, ATLS ETC.

52. DATA PROCESS INFORMATION:

COMPUTER ENTERED DATE 15/17/00
 MICROFILM INDEXED INITIAL KS

53. FILE APPROVAL

IS CASE CLASSIFICATION CORRECT? N
 IF N HAS CORRECTION BEEN MADE? Y

BY KE DATE 05/16/00

1. CASE # S99 No 02863 2. CLASSIFICATION 6310.11 3. CENSUS 7010.00

4. INCIDENT CS/S99-00242

5. INCIDENT LOCATION APPLETON - HWY 41

6. LAST-FIRST-MI [REDACTED] 7. D.O.B. [REDACTED]

8. ADDRESS [REDACTED] 9 TX-HOME [REDACTED]

11. CITY [REDACTED] STATE [REDACTED] ZIP [REDACTED] 10. TX-BUSINESS [REDACTED]

12. DETAILS SAW GRN CHEV VAN BEARING WI RP

SFE-447 W/ DAMAGE TO DRIVERS

SIDE OF GRILLE AROUND HEADLIGHT AT

MOASIS TRUCK STOP 4-10-99 AT 1100 HRS.

2012
66-11-7
14. REC'D
15. DISP
16. 10-23
17. 10-24
13. DAY
SUN 1 THU 5
MON 2 FRI 6
TUE 3 SAT 7
WED 4

MANITOWOC COUNTY SHERIFF
INCIDENT CARD

18 ASSIGNED MTSO 9129

19. REC. BY 932 20. DIS. BY

21. HOW REC'D.
1. 911
2. POLICE RADIO
3. PHONE
4. TTY
5. IN PERSON
6. ON VIEW
7. OFF. OFF DUTY
8. C.B. RADIO
9. OTHER

22. TYPE OF REPORT
1. INCIDENT
2. ACCIDENT
3. CITATION
4. NONE

23. STATUS
1. UNFOUNDED
2. PNL
3. OTHER
4. CLEARED
5. EXCEPT CLEARED

24. DATE CLEARED 01/13/99

25. OFFENSE TYPE
1. ADULT NA
2. JUVENILE
3. UNKNOWN

21A. M.O.

39. (CODE S-SUSPECT W-WITNESS V-VICTIM O-OTHER)	40. NAME-LAST	FIRST	MI	41. D.O.B.	42. ADDRESS	43. TELEPHONE
0	Kenny Lisa L.	1985	15		E. Canary St. Appleton 54915	
0	JONES	1985	16	PEBBLES M	W Bell St. Neenah 54956	
0	HEGNER	1985	17	LORIEN A	W Bell St. Neenah 54956	

2135hrs
04/25/99 Contacts have been attempted to make phone call contact with Lisa L. Kenny. The phone now has had an unlisted new number. Request contact be made by a squad and attempt to locate the vehicle the plates are on. Crime-Stopper reported vehicle with registration SFE 447 is a Chev Van. 10-28 shows its a Ford 2Dr. Thank you, M.J. Bushman

Description of Hit and Run vehicle I am looking for listed below:
Fax and TTY sent to Appleton PD requesting assistance.

04/26/99 0200hrs I, Lt. Bushman received a phone call from Kaukauna PD, the suspect vehicle has been located and damage was checked being unconsistant with the type damage described to them. Officer advised he had current address and phone for Kenny, full report will be forth coming. M.J. Bushman

04-28-99: I, Lt. Bushman, received TTY report from Kaukauna PD. The report states as follows. Appleton PD forwarded us the fax ref. the attempt to locate on a possible veh. for the hit & run. The veh. was located at [REDACTED] Lawe St. in the City of Kaukauna. The trim around the driver's side head light is missing with minor damage to the trim pieces on the fender. The area behind the trim pieces is very clean. There is no damage to the hood or bumper. There is a very small very piece of grill work missing near the head light assembly. Officer cannot tell if the shroud area had been replaced or not. The color of the veh. is green and the VIN# [REDACTED] which lists to a PEBBLES B. JONES or LORIEN HEGNER out of Neenah. The registration on the veh. would be SFE447 which would list to LISA KENNY.

It was noted that the damage described by Kaukauna at the time the phone conversation and the damage description of the TTY is not consistent with the damage we would expect to find on the suspect veh. This matter should be closed. MJBushman klf

45. IF COMPLAINANT DIFFERENT THEN CALLER, ENTER NAME, ADDRESS, D.O.B., TELEPHONE.

46. IF CODE O (OTHER) IS USED IN FIELD #39, EXPLAIN.

INCIDENT REPORT: NOTE: IF SECTION 22 ABOVE HAS NUMBER 4 CHECKED, DO NOT GO BEYOND THIS LINE WITHOUT RECORDS SECTION BEING ADVISED, OR NO RECORD ENTRIES WILL BE MADE BELOW THIS LINE.

PROPERTY VALUE	26. PROPERTY	A. CURRENCY	B. JEWELRY	C. FURS CLOTHING	D. VEHICLE (LOCAL)	E. OFFICE EQUIPMENT	F. RADIO, TV CAMERAS	G. FIREARMS	H. HOUSEHOLD GOODS
	STOLEN	\$	\$	\$	\$	\$	\$	\$	\$
	RECOVERED	\$	\$	\$	\$	\$	\$	\$	\$
	26. PROPERTY	I. CONSUMABLES	J. LIVESTOCK	K. DRUGS	L. MARINE ITEMS	M. CONSTRUCTION ITEMS	N. LAWN AND GARDEN	O. SPORTING GOODS	P. MISC BICYCLE
	STOLEN	\$	\$	\$	\$	\$	\$	\$	\$
	RECOVERED	\$	\$	\$	\$	\$	\$	\$	\$

27. PROPERTY RECOVERED: LOCALLY _____ OTHER JURISDICTION _____ (INSERT O OR L)

PROPERTY ITEMIZATION	PROPERTY STOLEN/RECOVERED ITEMIZATION, USE THE FOLLOWING FORMAT				
	28. QUANTITY	29. ARTICLE NAME	30. BRAND NAME	31. SERIAL NUMBER	32. CODE
					S <input type="checkbox"/> R <input type="checkbox"/>
					S <input type="checkbox"/> R <input type="checkbox"/>
					S <input type="checkbox"/> R <input type="checkbox"/>
					S <input type="checkbox"/> R <input type="checkbox"/>
					S <input type="checkbox"/> R <input type="checkbox"/>

33. PROPERTY DAMAGE AMOUNT \$ _____ 34. INSURANCE COMPANY _____

35. OFFICER ASSAULTED Y N 36. ARSON Y N 37. STRUCTURE CODE _____ 38. DAMAGE \$ _____

47. CIB <input type="checkbox"/>	ENTERED <input type="checkbox"/>	CANCELLED <input type="checkbox"/>	48. TOTAL AMOUNT PROPERTY STOLEN \$ _____
NCIC <input type="checkbox"/>	<input type="checkbox"/>	<input type="checkbox"/>	
OTHER BROADCAST <input type="checkbox"/>	<input type="checkbox"/>	<input type="checkbox"/>	

49. TOTAL AMOUNT PROPERTY RECOVERED \$ _____

50. IS REPORT CONTINUED? YES NO 51. CAUTION INDICATORS, ATLS ETC.

52. DATA PROCESS INFORMATION:

COMPUTER ENTERED DATE 11/29/99

MICROFILM INDEXED INITIAL RS

IS CASE CLASSIFICATION CORRECT? Y N

IF N HAS CORRECTION BEEN MADE? Y N

53. FILE APPROVAL

BY [Signature] DATE 12/30/99

Manitowoc County Sheriff's Department

Thomas H. Kocourek
SHERIFF



Kenneth J. Petersen
INSPECTOR

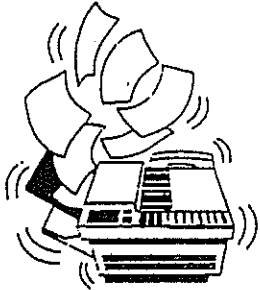

FAX

DATE 4-25-99

TO: APPLETON PD.

FAX #: ████ / █████

FROM: LT. MIKE BUSHMAN

NUMBER OF PAGES SENT INCLUDING THIS ONE 2

CONFIDENTIALITY NOTICE

This message is intended only for the use of the individual or entity to which it is addressed and may contain information that is privileged, confidential, and exempt from disclosure under applicable law. If the reader of this message is not the intended recipient or the employee or agent responsible for delivering the message to the intended recipient, you are hereby notified that any dissemination, distribution, or copying of this communication is strictly prohibited. If you have received this communication in error, please notify us immediately by telephone and return the original message to us at the above address via the U.S. Postal Service. Thank you.

SHERIFF'S DEPT FAX NUMBERS: █████

████ - Detectives █████ - Dispatch █████ - Jail █████ - Juvenile
████ - Metro █████ - Records/Administration

1. CASE # S99 - 02874
2. CLASSIFICATION 6,310,1
3. CENSUS 5,210,00

4. INCIDENT CS/S99-00242

5. INCIDENT LOCATION WOODLAND CLINIC, MTWC.

6. NAME-LAST-FIRST-MI [REDACTED] 7. D.O.B. [REDACTED]

8. ADDRESS [REDACTED] 9. TX-HOME [REDACTED]

11. CITY [REDACTED] STATE [REDACTED] ZIP [REDACTED] 10. TX-BUSINESS [REDACTED]

12. DETAIL CALLER STATES SHE SEEN A RED CHEV PICKUP BEARING W. RP#

85037F IN PARKING LOT. HAD A

BLACK SPRAY PAINTED GRILL W/OVERSPRAY ON HOOD. DID NOT SEE ANY OTHER DAMAGE.

1735
4-12-99
14. REC'D. 15. DISP. 16. 10-23 17. 10-24
13. DAY
SUN 1 THU 5
MON 2 FRI 6
TUE 3 SAT 7
WED 4

MANITOWOC COUNTY SHERIFF
INCIDENT CARD

18. ASSIGNED MTSC 9129

19. REC. BY 932 20. DIS. BY

22. TYPE OF REPORT
1. INCIDENT
2. ACCIDENT
3. CITATION
4. NONE

23. STATUS
1. UNFOUNDED
2. PNL
3. OTHER
4. CLEARED
5. EXCEPT CLEARED

24. DATE CLEARED 04/28/99

25. OFFENSE TYPE
1. ADULT NA
2. JUVENILE
3. UNKNOWN

21. HOW REC'D.
1. 911
2. POLICE RADIO
3. PHONE
4. TTY
5. IN PERSON
6. ON VIEW
7. OFF. OFF DUTY
8. C.B. RADIO
9. OTHER

21A. M.O.

39. (CODE S-SUSPECT W-WITNESS V-VICTIM O-OTHER)						
CODE	40. NAME-LAST	FIRST	MI	41. D.O.B.	42. ADDRESS	43. TELEPHONE
0	Ebert,	John S.	2519	[REDACTED]	PO Box [REDACTED] Reedsville	

04/16/99 2233hrs Reedsville PD DI Tisler agreed to check vehicle if it could be seen from the street. 1990 should be a newer model design if registration is current for correct vehicle. M.J.Bushman

04/20/99 1715hrs Contact made by KDT and radio with 479Tisler working patrol. He knows the above listed owner of the vehicle and was able to locate the vehicle at the owner's farm property in rural Reedsville. The truck is red, has the blk painted grill but no other damage. It would also be of the newer style, not the style Chev. we are looking for, registration matches that truck and owner has no other Chev. trucks. Close Out M.J.Bushman

04/28/99 417 entered info into computer 0555 hrs. EJC ETC

45. IF COMPLAINANT DIFFERENT THEN CALLER, ENTER NAME, ADDRESS, D.O.B., TELEPHONE.

46. IF CODE O (OTHER) IS USED IN FIELD #39, EXPLAIN.

INCIDENT REPORT: NOTE: IF SECTION 22 ABOVE HAS NUMBER 4 CHECKED, DO NOT GO BEYOND THIS LINE WITHOUT RECORDS SECTION BEING ADVISED, OR NO RECORD ENTRIES WILL BE MADE BELOW THIS LINE.

PROPERTY VALUE	26. PROPERTY	A. CURRENCY	B. JEWELRY	C. FURS CLOTHING	D. VEHICLE (LOCAL)	E. OFFICE EQUIPMENT	F. RADIO, TV CAMERAS	G. FIREARMS	H. HOUSE-HOLD GOODS
	STOLEN	\$	\$	\$	\$	\$	\$	\$	\$
	RECOVERED	\$	\$	\$	\$	\$	\$	\$	\$
	26. PROPERTY	I. CONSUMABLES	J. LIVESTOCK	K. DRUGS	L. MARINE ITEMS	M. CONSTRUCTION ITEMS	N. LAWN AND GARDEN	O. SPORTING GOODS	P. MISC BICYCLE
	STOLEN	\$	\$	\$	\$	\$	\$	\$	\$
	RECOVERED	\$	\$	\$	\$	\$	\$	\$	\$

27. PROPERTY RECOVERED: LOCALLY _____ OTHER JURISDICTION _____ (INSERT O OR L)

PROPERTY ITEMIZATION	PROPERTY STOLEN/RECOVERED ITEMIZATION, USE THE FOLLOWING FORMAT			
	28. QUANTITY	29. ARTICLE NAME	30. BRAND NAME	31. SERIAL NUMBER
				S R <input type="checkbox"/> <input type="checkbox"/>
				S R <input type="checkbox"/> <input type="checkbox"/>
				S R <input type="checkbox"/> <input type="checkbox"/>
				S R <input type="checkbox"/> <input type="checkbox"/>

33. PROPERTY DAMAGE AMOUNT \$ _____ 34. INSURANCE COMPANY _____

35. OFFICER ASSAULTED Y N 36. ARSON Y N 37. STRUCTURE CODE _____ 38. DAMAGE \$ _____

47. CIB	ENTERED <input type="checkbox"/>	CANCELLED <input type="checkbox"/>	48. TOTAL AMOUNT PROPERTY STOLEN \$ _____
NCIC	<input type="checkbox"/>	<input type="checkbox"/>	
OTHER BROADCAST	<input type="checkbox"/>	<input type="checkbox"/>	49. TOTAL AMOUNT PROPERTY RECOVERED \$ _____

50. IS REPORT CONTINUED? YES NO 51. CAUTION INDICATORS, ATLS ETC.

52. DATA PROCESS INFORMATION:

COMPUTER ENTERED DATE 16 10 99
 MICROFILM INDEXED INITIAL AS

IS CASE CLASSIFICATION CORRECT? Y N
 IF N HAS CORRECTION BEEN MADE? Y N

53. FILE APPROVAL
 BY [Signature] DATE 0428 99

45. IF COMPLAINANT DIFFERENT THEN CALLER, ENTER NAME, ADDRESS,

46. IF CODE O (OTHER) IS USED IN FIELD #39, EXPLAIN.

INCIDENT REPORT: NOTE: IF SECTION 22 ABOVE HAS NUMBER 4 CHECKED, DO NOT GO BEYOND THIS LINE WITHOUT RECORDS SECTION BEING ADVISED, OR NO RECORD ENTRIES WILL BE MADE BELOW THIS LINE.

PROPERTY VALUE	26. PROPERTY	A. CURRENCY	B. JEWELRY	C. FURS CLOTHING	D. VEHICLE (LOCAL)	E. OFFICE EQUIPMENT	F. RADIO, TV CAMERAS	G. FIREARMS	H. HOUSE-HOLD GOODS
	STOLEN	\$	\$	\$	\$	\$	\$	\$	\$
	RECOVERED	\$	\$	\$	\$	\$	\$	\$	\$
	26. PROPERTY	I. CONSUMABLES	J. LIVESTOCK	K. DRUGS	L. MARINE ITEMS	M. CONSTRUCTION ITEMS	N. LAWN AND GARDEN	O. SPORTING GOODS	P. MISC BICYCLE
STOLEN	\$	\$	\$	\$	\$	\$	\$	\$	
RECOVERED	\$	\$	\$	\$	\$	\$	\$	\$	

27. PROPERTY RECOVERED: LOCALLY ____ OTHER JURISDICTION ____ (INSERT O OR L)

PROPERTY ITEMIZATION	PROPERTY STOLEN/RECOVERED ITEMIZATION, USE THE FOLLOWING FORMAT			
	28. QUANTITY	29. ARTICLE NAME	30. BRAND NAME	31. SERIAL NUMBER
				S R <input type="checkbox"/> <input type="checkbox"/>
				S R <input type="checkbox"/> <input type="checkbox"/>
				S R <input type="checkbox"/> <input type="checkbox"/>
				S R <input type="checkbox"/> <input type="checkbox"/>
				S R <input type="checkbox"/> <input type="checkbox"/>

33. PROPERTY DAMAGE AMOUNT \$ _____ 34. INSURANCE COMPANY _____

35. OFFICER ASSAULTED Y N 36. ARSON Y N 37. STRUCTURE CODE _____ 38. DAMAGE \$ _____

47. CIB ENTERED CANCELLED
 NCIC
 OTHER BROADCAST

48. TOTAL AMOUNT PROPERTY STOLEN \$ _____

49. TOTAL AMOUNT PROPERTY RECOVERED \$ _____

50. IS REPORT CONTINUED? YES NO

51. CAUTION INDICATORS, ATLS ETC.

52. DATA PROCESS INFORMATION:

COMPUTER ENTERED DATE 10/29/99
 MICROFILM INDEXED INITIAL JS

53. FILE APPROVAL

IS CASE CLASSIFICATION CORRECT? Y N
 IF N HAS CORRECTION BEEN MADE? Y N

BY _____ DATE _____

1. CASE # S99 No 03032 | 2. CLASSIFICATION 63011 | 3. CENSUS 521000

4. INCIDENT CS/599-00242

5. INCIDENT LOCATION City of Mtwc

6. NAME - LAST - FIRST - MI Anon | 7. D.O.B.

8. ADDRESS | 9. TX-HOME

11. CITY STATE ZIP | 10. TX-BUSINESS

12. DETAILS See attached H5J554

4-16-99 9:20

14. REC'D | 15. DISP | 16. 10-23 | 17. 10-24

13. DAY
 SUN 1 | THU 5
 MON 2 | **FRI 6**
 TUE 3 | SAT 7
 WED 4

MANITOWOC COUNTY SHERIFF
INCIDENT CARD

18. ASSIGNED MTSO 929

19. REC. BY 926 | 20. DIS. BY

21. HOW REC'D.
 1. 911
 2. POLICE RADIO
 3. PHONE
 4. TTY
 5. IN PERSON
 6. ON VIEW
 7. OFF. OFF DUTY
 8. C.B. RADIO
 9. OTHER

22. TYPE OF REPORT
 1. INCIDENT
 2. ACCIDENT
 3. CITATION
 4. NONE

23. STATUS
 1. UNFOUNDED
 2. PNL
 3. OTHER
 4. CLEARED
 5. EXCEPT CLEARED

24. DATE CLEARED 04/20/99

25. OFFENSE TYPE
 1. ADULT NA
 2. JUVENILE
 3. UNKNOWN

39. (CODE S-SUSPECT W-WITNESS V-VICTIM O-OTHER)

CODE	40. NAME - LAST	FIRST	MI	41. D.O.B.	42. ADDRESS	43. TELEPHONE
O	Mueller	Mark D.			Meadow Lane, Mtwc	

04/16/99 2300hrs Officer did a driveby of the residence and observed a Chev Astro van blue/gray color parked in the driveway. Registration was checked and found to be the number called in on the CrimeStoppers complaint, H5J554. The vehicle was checked and found to have the damage described on the complaint. This would not be the suspect vehicle, close out
 M.J. Bushmat

45. IF COMPLAINANT DIFFERENT THEN CALLER, ENTER NAME, ADDRESS, D.O.B., TELEPHONE.

46. IF CODE O (OTHER) IS USED IN FIELD #39, EXPLAIN.

INCIDENT REPORT: NOTE: IF SECTION 22 ABOVE HAS NUMBER 4 CHECKED, DO NOT GO BEYOND THIS LINE WITHOUT RECORDS SECTION BEING ADVISED, OR NO RECORD ENTRIES WILL BE MADE BELOW THIS LINE.

PROPERTY VALUE	26. PROPERTY	A. CURRENCY	B. JEWELRY	C. FURS CLOTHING	D. VEHICLE (LOCAL)	E. OFFICE EQUIPMENT	F. RADIO, TV CAMERAS	G. FIREARMS	H. HOUSE-HOLD GOODS
	STOLEN	\$	\$	\$	\$	\$	\$	\$	\$
	RECOVERED	\$	\$	\$	\$	\$	\$	\$	\$
	26. PROPERTY	I. CONSUM-ABLES	J. LIVESTOCK	K. DRUGS	L. MARINE ITEMS	M. CONSTRUCTION ITEMS	N. LAWN AND GARDEN	O. SPORTING GOODS	P. MISC BICYCLE
	STOLEN	\$	\$	\$	\$	\$	\$	\$	\$
	RECOVERED	\$	\$	\$	\$	\$	\$	\$	\$

27. PROPERTY RECOVERED: LOCALLY _____ OTHER JURISDICTION _____ (INSERT O OR L)

PROPERTY ITEMIZATION	PROPERTY STOLEN/RECOVERED ITEMIZATION, USE THE FOLLOWING FORMAT				
	28. QUANTITY	29. ARTICLE NAME	30. BRAND NAME	31. SERIAL NUMBER	32. CODE
					S R <input type="checkbox"/> <input type="checkbox"/>
					S R <input type="checkbox"/> <input type="checkbox"/>
					S R <input type="checkbox"/> <input type="checkbox"/>
					S R <input type="checkbox"/> <input type="checkbox"/>

33. PROPERTY DAMAGE AMOUNT \$ _____

34. INSURANCE COMPANY _____

35. OFFICER ASSAULTED Y N

36. ARSON Y N

37. STRUCTURE CODE _____ 38. DAMAGE \$ _____

47. CIB ENTERED CANCELLED
 NCIC
 OTHER BROADCAST

48. TOTAL AMOUNT PROPERTY STOLEN \$ _____

49. TOTAL AMOUNT PROPERTY RECOVERED \$ _____

50. IS REPORT CONTINUED? YES NO

51. CAUTION INDICATORS, ATLS ETC.

52. DATA PROCESS INFORMATION:

COMPUTER ENTERED DATE 6/29/99
 MICROFILM INDEXED INITIAL AS

53. FILE APPROVAL

IS CASE CLASSIFICATION CORRECT? IF N HAS CORRECTION BEEN MADE? N

BY gmd DATE 6/29/99

1. CASE # S99 No 03098 | 2. CLASSIFICATION 63011 | 3. CENSUS 52000

4. INCIDENT CS/S99-00242

5. INCIDENT LOCATION SUPER SAVER PK lot

6. NAME - LAST-FIRST-MI ANONY. | 7. D.O.B.

8. ADDRESS | 9. TX-HOME

11. CITY | STATE | ZIP | 10. TX-BUSINESS REG# 42492 (no letters)

12. DETAILS
Saw Ford Ranger w/que
damage in Super Saver
pk lot on 5/18/99 around
11:30 hrs. Driver was m/w
in 30's - bought raku.

04/19/99 11:16

14. REC'D.	15. DISP.	16. 10-23	17. 10-24
SUN 1	THU 5		
MON 2	FRI 6		
TUE 3	SAT 7		
WED 4			

MANITOWOC COUNTY SHERIFF
INCIDENT CARD

18. ASSIGNED MT50 929

19. REC. BY 020 | 20. DIS. BY

21. HOW REC'D.
1. 911
2. POLICE RADIO
3. PHONE
4. TTY
5. IN PERSON
6. ON VIEW
7. OFF. OFF DUTY
8. C.B. RADIO
9. OTHER

22. TYPE OF REPORT
 INCIDENT
 ACCIDENT
 CITATION
 NONE

23. STATUS
1. UNFOUNDED
2. PNL
3. OTHER
4. CLEARED
5. EXCEPT CLEARED

24. DATE CLEARED 04/18/99

25. OFFENSE TYPE
1. ADULT NA
2. JUVENILE
3. UNKNOWN

MILWAUKEE COUNTY

39. (CODE S-SUSPECT W-WITNESS V-VICTIM O-OTHER)						
CODE	40. NAME-LAST	FIRST	MI	41. D.O.B.	42. ADDRESS	43. TELEPHONE

04/19/99 Call is anonymous, no CrimeStopper report attached. We are looking for a Chev. not a Ford product. The above registration numbers were run numerous ways by the dispatch and nothing came back close. Close Out. M.J. Bushman

04/28/99 entered into computer. EJK BTG

45. IF COMPLAINANT DIFFERENT THEN CALLER, ENTER NAME, ADDRESS, D.O.B., TELEPHONE.

46. IF CODE O (OTHER) IS USED IN FIELD #39, EXPLAIN.

INCIDENT REPORT: NOTE: IF SECTION 22 ABOVE HAS NUMBER 4 CHECKED, DO NOT GO BEYOND THIS LINE WITHOUT RECORDS SECTION BEING ADVISED, OR NO RECORD ENTRIES WILL BE MADE BELOW THIS LINE.

PROPERTY VALUE	26. PROPERTY	A. CURRENCY	B. JEWELRY	C. FURS CLOTHING	D. VEHICLE (LOCAL)	E. OFFICE EQUIPMENT	F. RADIO, TV CAMERAS	G. FIREARMS	H. HOUSE-HOLD GOODS
	STOLEN	\$	\$	\$	\$	\$	\$	\$	\$
	RECOVERED	\$	\$	\$	\$	\$	\$	\$	\$
	26. PROPERTY	I. CONSUMABLES	J. LIVESTOCK	K. DRUGS	L. MARINE ITEMS	M. CONSTRUCTION ITEMS	N. LAWN AND GARDEN	O. SPORTING GOODS	P. MISC BICYCLE
	STOLEN	\$	\$	\$	\$	\$	\$	\$	\$
	RECOVERED	\$	\$	\$	\$	\$	\$	\$	\$

27. PROPERTY RECOVERED: LOCALLY _____ OTHER JURISDICTION _____ (INSERT O OR L)

PROPERTY ITEMIZATION	PROPERTY STOLEN/RECOVERED ITEMIZATION, USE THE FOLLOWING FORMAT				
	28. QUANTITY	29. ARTICLE NAME	30. BRAND NAME	31. SERIAL NUMBER	32. CODE
					S R <input type="checkbox"/> <input type="checkbox"/>
					S R <input type="checkbox"/> <input type="checkbox"/>
					S R <input type="checkbox"/> <input type="checkbox"/>
					S R <input type="checkbox"/> <input type="checkbox"/>
					S R <input type="checkbox"/> <input type="checkbox"/>

33. PROPERTY DAMAGE AMOUNT \$ _____ 34. INSURANCE COMPANY _____

35. OFFICER ASSAULTED Y N 36. ARSON Y N 37. STRUCTURE CODE _____ 38. DAMAGE \$ _____

47. CIB NCIC OTHER BROADCAST	ENTERED	CANCELLED	48. TOTAL AMOUNT PROPERTY STOLEN \$ _____
	<input type="checkbox"/>	<input type="checkbox"/>	
	<input type="checkbox"/>	<input type="checkbox"/>	
			49. TOTAL AMOUNT PROPERTY RECOVERED \$ _____

50. IS REPORT CONTINUED? YES NO 51. CAUTION INDICATORS, ATLS ETC.

52. DATA PROCESS INFORMATION:
 COMPUTER ENTERED DATE 6/29/99
 MICROFILM INDEXED INITIAL KS
 IS CASE CLASSIFICATION CORRECT? Y N
 IF N HAS CORRECTION BEEN MADE? Y N

53. FILE APPROVAL
 BY [Signature] DATE 6/26/99

1. CASE # **S99 No 03160** | 2. CLASSIFICATION **6.310.11** | 3. CENSUS **5.210.00**

4. INCIDENT **PS 599-00242**

5. INCIDENT LOCATION **MTWC**

6. NAME - LAST - FIRST - MI **ANONY (2)** | 7. D.O.B.

8. ADDRESS | 9. TX-HOME

11. CITY | STATE | ZIP | 10. TX-BUSINESS

12. DETAILS **REPORTS SEEING CHEVROLET**

SILVERADO 10, LT BLUE, LIC AH13946

GRILLE DAMAGE ONLY

1800
 67-189
 H-21-99
 REC'D 14. 15. 16. 17.
 DISP 10-23 10-24
 13. DAY
 SUN 1 THU 5
 MON 2 FRI 6
 TUE 3 SAT 7
 WED 4

**MANITOWOC COUNTY SHERIFF
INCIDENT CARD**

18. ASSIGNED **INFO** | 91311

19. REC. BY **939** | 20. DIS. BY

21. HOW REC'D.
 1. 911
 2. POLICE RADIO
 3. PHONE
 4. TTY
 5. IN PERSON
 6. ON VIEW
 7. OFF. OFF DUTY
 8. C.B. RADIO
 9. OTHER
 21A. M.O.

22. TYPE OF REPORT
 1. INCIDENT
 2. ACCIDENT
 3. CITATION
 4. NONE

23. STATUS
 1. UNFOUNDED
 2. PNL
 3. OTHER
 4. CLEARED
 5. EXCEPT CLEARED

24. DATE CLEARED **09/30/99**

25. OFFENSE TYPE
 1. ADULT NA
 2. JUVENILE
 3. UNKNOWN

39. (CODE S-SUSPECT W-WITNESS V-VICTIM O-OTHER)

CODE	40. NAME-LAST	FIRST	MI	41. D.O.B.	42. ADDRESS	43. TELEPHONE

04/25/99 2115hrs Vehicle had been checked S99-00401. Close out M.J. Bushman.

45. IF COMPLAINANT DIFFERENT THEN CALLER, ENTER NAME, ADDRESS, D.O.B., TELEPHONE.

46. IF CODE O (OTHER) IS USED IN FIELD #39, EXPLAIN.

INCIDENT REPORT: NOTE: IF SECTION 22 ABOVE HAS NUMBER 4 CHECKED, DO NOT GO BEYOND THIS LINE WITHOUT RECORDS SECTION BEING ADVISED, OR NO RECORD ENTRIES WILL BE MADE BELOW THIS LINE.

PROPERTY VALUE	26. PROPERTY	A. CURRENCY	B. JEWELRY	C. FURS CLOTHING	D. VEHICLE (LOCAL)	E. OFFICE EQUIPMENT	F. RADIO, TV CAMERAS	G. FIREARMS	H. HOUSEHOLD GOODS
	STOLEN	\$	\$	\$	\$	\$	\$	\$	\$
	RECOVERED	\$	\$	\$	\$	\$	\$	\$	\$
	26. PROPERTY	I. CONSUMABLES	J. LIVESTOCK	K. DRUGS	L. MARINE ITEMS	M. CONSTRUCTION ITEMS	N. LAWN AND GARDEN	O. SPORTING GOODS	P. MISC BICYCLE
	STOLEN	\$	\$	\$	\$	\$	\$	\$	\$
	RECOVERED	\$	\$	\$	\$	\$	\$	\$	\$

27. PROPERTY RECOVERED: LOCALLY _____ OTHER JURISDICTION _____ (INSERT O OR L)

PROPERTY ITEMIZATION	PROPERTY STOLEN/RECOVERED ITEMIZATION, USE THE FOLLOWING FORMAT				
	28. QUANTITY	29. ARTICLE NAME	30. BRAND NAME	31. SERIAL NUMBER	32. CODE
					S <input type="checkbox"/> R <input type="checkbox"/>
					S <input type="checkbox"/> R <input type="checkbox"/>
					S <input type="checkbox"/> R <input type="checkbox"/>
					S <input type="checkbox"/> R <input type="checkbox"/>
					S <input type="checkbox"/> R <input type="checkbox"/>

33. PROPERTY DAMAGE AMOUNT \$ _____

34. INSURANCE COMPANY _____

35. OFFICER ASSAULTED Y N 36. ARSON Y N 37. STRUCTURE CODE _____ 38. DAMAGE \$ _____

47. CIB ENTERED CANCELLED
 NCIC
 OTHER BROADCAST

48. TOTAL AMOUNT PROPERTY STOLEN \$ _____

49. TOTAL AMOUNT PROPERTY RECOVERED \$ _____

50. IS REPORT CONTINUED? YES NO

51. CAUTION INDICATORS, ATLS ETC.

52. DATA PROCESS INFORMATION:

COMPUTER ENTERED DATE 11/29/99
 MICROFILM INDEXED INITIAL KS

53. FILE APPROVAL

IS CASE CLASSIFICATION CORRECT? Y N
 IF N HAS CORRECTION BEEN MADE? Y N

BY [Signature] DATE 11/30/99

45. IF COMPLAINANT DIFFERENT THEN CALLER, ENTER NAME, ADDRESS, D.O.B., TELEPHONE.

46. IF CODE O (OTHER) IS USED IN FIELD #39, EXPLAIN.

INCIDENT REPORT: NOTE: IF SECTION 22 ABOVE HAS NUMBER 4 CHECKED, DO NOT GO BEYOND THIS LINE WITHOUT RECORDS SECTION BEING ADVISED, OR NO RECORD ENTRIES WILL BE MADE BELOW THIS LINE.

PROPERTY VALUE	26. PROPERTY	A. CURRENCY	B. JEWELRY	C. FURS CLOTHING	D. VEHICLE (LOCAL)	E. OFFICE EQUIPMENT	F. RADIO, TV CAMERAS	G. FIREARMS	H. HOUSEHOLD GOODS
	STOLEN	\$	\$	\$	\$	\$	\$	\$	\$
	RECOVERED	\$	\$	\$	\$	\$	\$	\$	\$
	26. PROPERTY	I. CONSUMABLES	J. LIVESTOCK	K. DRUGS	L. MARINE ITEMS	M. CONSTRUCTION ITEMS	N. LAWN AND GARDEN	O. SPORTING GOODS	P. MISC BICYCLE
STOLEN	\$	\$	\$	\$	\$	\$	\$	\$	
RECOVERED	\$	\$	\$	\$	\$	\$	\$	\$	

27. PROPERTY RECOVERED: LOCALLY _____ OTHER JURISDICTION _____ (INSERT O OR L)

PROPERTY ITEMIZATION	PROPERTY STOLEN/RECOVERED ITEMIZATION, USE THE FOLLOWING FORMAT			
	28. QUANTITY	29. ARTICLE NAME	30. BRAND NAME	31. SERIAL NUMBER
				S R <input type="checkbox"/> <input type="checkbox"/>
				S R <input type="checkbox"/> <input type="checkbox"/>
				S R <input type="checkbox"/> <input type="checkbox"/>
				S R <input type="checkbox"/> <input type="checkbox"/>
				S R <input type="checkbox"/> <input type="checkbox"/>

33. PROPERTY DAMAGE AMOUNT \$ _____ 34. INSURANCE COMPANY _____

35. OFFICER ASSAULTED Y N 36. ARSON Y N 37. STRUCTURE CODE _____ 38. DAMAGE \$ _____

47. CIB ENTERED <input type="checkbox"/> CANCELLED <input type="checkbox"/> NCIC <input type="checkbox"/> <input type="checkbox"/> OTHER BROADCAST <input type="checkbox"/> <input type="checkbox"/>	48. TOTAL AMOUNT PROPERTY STOLEN \$ _____ 49. TOTAL AMOUNT PROPERTY RECOVERED \$ _____
--	---

50. IS REPORT CONTINUED? YES NO 51. CAUTION INDICATORS, ATLS ETC.

52. DATA PROCESS INFORMATION:

COMPUTER ENTERED DATE 6 29 99
 MICROFILM INDEXED INITIAL KS

IS CASE CLASSIFICATION CORRECT? IF N HAS CORRECTION BEEN MADE? Y N

53. FILE APPROVAL
 BY [Signature] DATE 6/29/99

MCSO 028 1/91

1. CASE # **S99 No 03214** 2. CLASSIFICATION **6,310,11** 3. CENSUS **5,300,0**

4. INCIDENT **CS/S99-00242**

5. INCIDENT LOCATION **TWO RIVERS**

6. NAME - LAST - FIRST - MI **WOLF DOUGLAS A.** 7. D.O.B. [REDACTED]

8. ADDRESS **[REDACTED] -13 ST.** 9. TX-HOME [REDACTED]

11. CITY **TWO RIVERS** STATE **WI** ZIP **54241** 10. TX-BUSINESS [REDACTED]

12. DETAILS

1215
4-21-99

MANITOWOC COUNTY SHERIFF INCIDENT CARD

18. ASSIGNED **JOST** **4449**

19. REC. BY **932** 20. DIS. BY **-**

21. HOW REC'D.
 1. 911
 2. POLICE RADIO
 3. PHONE
 4. TTY
 5. IN PERSON
 6. ON VIEW
 7. OFF. OFF DUTY
 8. C.B. RADIO
 9. OTHER
 21A. M.O.

22. TYPE OF REPORT
 1. UNFOUNDED
 2. STATUS
 3. CITATION
 4. NONE
 5. EXCEPT CLEARED
 23. STATUS
 1. UNFOUNDED
 2. PNL
 3. OTHER
 4. CLEARED
 5. EXCEPT CLEARED
 24. DATE CLEARED **04/30/99**
 25. OFFENSE TYPE
 1. ADULT NA
 2. JUVENILE
 3. UNKNOWN

14. REC'D	15. DISP	16. 10-23	17. 10-24
13. DAY			
SUN 1	THU 5		
MON 2	FRI <input checked="" type="checkbox"/>		
TUE 3	SAT 7		
WED 4			

39. CODE	40. NAME - LAST	FIRST	MI	41. D.O.B.	42. ADDRESS	43. TELEPHONE
0	WOLF	36940	DOUGLAS	A	[REDACTED] 13th St, Two Rivers	[REDACTED]

04/21/99: I, Deputy Jost, made contact with Lt. Mixa from TRPD reference a report he had taken from DOUGLAS WOLF about a vehicle DOUGLAS had just purchased. I was told DOUGLAS had recently purchased a 1978 Chevy K5 Blazer and he was a little suspicious as he purchased the vehicle for what he thought was a low price.

In talking to Lt. Mixa, he stated he looked over the truck and saw that it appeared that it had fresh paint on the vehicle. The original color was blue and it was now painted black. Lt. Mixa also advised that it appeared that the windshield had been replaced by someone that did not know or have the right tools to replace it properly.

I was able to locate the Blazer at FISHER HAMILTON on Columbus St. in Two Rivers. While there I made contact with DOUGLAS WOLF and also the previous owner, DAVID SHEFFER. In talking to both parties, DOUGLAS told me he was somewhat suspicious because he purchased the truck for \$450.00 and again he noticed the fresh black paint on the truck. In looking over the Blazer it appeared the grille was the original grille as the screws did not appear they had recently been removed. In looking over the fan shroud under the hood, this was fully intact and it did not appear as though anybody had tampered or removed it recently. Also looking over the black paint, the entire truck was repainted black probably not being done by a professional. This, however, being my opinion. Looking at the windshield, there was a crack on the passenger side of the windshield and it appeared as though the windshield had been replaced sometime ago, probably before the hit and run fatality accident reference case #S99-00242.

In talking to DAVID, he had also thought about calling after he purchased it from TRAVIS WILSON; however, he failed to do so.

Reference this vehicle, I do not believe any other follow-up will need to be done due to the year of the vehicle and nothing else matching with what we are looking for.

JJost

/paf

417CA EN 685

45. IF COMPLAINANT DIFFERENT THEN CALLER, ENTER NAME, ADDRESS, D.O.B., TELEPHONE.

46. IF CODE O (OTHER) IS USED IN FIELD #39, EXPLAIN.

INCIDENT REPORT: NOTE: IF SECTION 22 ABOVE HAS NUMBER 4 CHECKED, DO NOT GO BEYOND THIS LINE WITHOUT RECORDS SECTION BEING ADVISED, OR NO RECORD ENTRIES WILL BE MADE BELOW THIS LINE.

PROPERTY VALUE	26. PROPERTY	A. CURRENCY	B. JEWELRY	C. FURS CLOTHING	D. VEHICLE (LOCAL)	E. OFFICE EQUIPMENT	F. RADIO, TV CAMERAS	G. FIREARMS	H. HOUSE-HOLD GOODS
	STOLEN	\$	\$	\$	\$	\$	\$	\$	\$
	RECOVERED	\$	\$	\$	\$	\$	\$	\$	\$
	26. PROPERTY	I. CONSUMABLES	J. LIVESTOCK	K. DRUGS	L. MARINE ITEMS	M. CONSTRUCTION ITEMS	N. LAWN AND GARDEN	O. SPORTING GOODS	P. MISC BICYCLE
	STOLEN	\$	\$	\$	\$	\$	\$	\$	\$
	RECOVERED	\$	\$	\$	\$	\$	\$	\$	\$

27. PROPERTY RECOVERED: LOCALLY _____ OTHER JURISDICTION _____ (INSERT O OR L)

PROPERTY ITEMIZATION	PROPERTY STOLEN/RECOVERED ITEMIZATION, USE THE FOLLOWING FORMAT				
	28. QUANTITY	29. ARTICLE NAME	30. BRAND NAME	31. SERIAL NUMBER	32. CODE
					S <input type="checkbox"/> R <input type="checkbox"/>
					S <input type="checkbox"/> R <input type="checkbox"/>
					S <input type="checkbox"/> R <input type="checkbox"/>
					S <input type="checkbox"/> R <input type="checkbox"/>
					S <input type="checkbox"/> R <input type="checkbox"/>

33. PROPERTY DAMAGE AMOUNT \$ _____ 34. INSURANCE COMPANY _____

35. OFFICER ASSAULTED Y N 36. ARSON Y N 37. STRUCTURE CODE _____ 38. DAMAGE \$ _____

47. CIB <input type="checkbox"/>	ENTERED <input type="checkbox"/>	CANCELLED <input type="checkbox"/>	48. TOTAL AMOUNT PROPERTY STOLEN \$ _____
NCIC <input type="checkbox"/>	<input type="checkbox"/>	<input type="checkbox"/>	
OTHER BROADCAST <input type="checkbox"/>	<input type="checkbox"/>	<input type="checkbox"/>	

49. TOTAL AMOUNT PROPERTY RECOVERED \$ _____

50. IS REPORT CONTINUED? YES NO

51. CAUTION INDICATORS, ATLS ETC.

52. DATA PROCESS INFORMATION:

COMPUTER ENTERED DATE 16/09/99

MICROFILM INDEXED INITIAL KS

IS CASE CLASSIFICATION CORRECT? Y N

IF N HAS CORRECTION BEEN MADE? Y N

53. FILE APPROVAL

BY [Signature] DATE 09/30/99

1. CASE # S99 No 03235 2. CLASSIFICATION 6310.11 3. CENSUS 70100.0

4. INCIDENT CS / See 599-00242

5. INCIDENT LOCATION SHEBOYGAN

6. NAME LAST FIRST MI [REDACTED] 7. D.O.B. [REDACTED] 127593

8. ADDRESS [REDACTED] 9. TX-HOME [REDACTED]

11. CITY [REDACTED] STATE [REDACTED] ZIP [REDACTED] 10. TX-BUSINESS [REDACTED]

12. DETAILS COMPL. REPORTS OBSERVING CHEV

BLAZER IN SHEB. W/ FRT.

DAMAGE (SEE ATTACHED)

1115 04-24-99
1150 04-24-99
14. REC'D
15. DISP
16. 10-23
17. 10-24
13. DAY
SUN 1 THU 5
MON 2 FRI 6
TUE 3 SAT 7
WED 4

MANITOWOC COUNTY SHERIFF
INCIDENT CARD

18. ASSIGNED MTSO 929
COLBORN 432

19. REC. BY 930 20. DIS. BY 930

21. HOW REC'D.
1. 911
2. POLICE RADIO
3. PHONE
4. TTY
5. IN PERSON
6. ON VIEW
7. OFF. OFF DUTY
8. C.B. RADIO
9. OTHER

22. TYPE OF REPORT
1. INCIDENT
2. ACCIDENT
3. CITATION
4. NONE

23. STATUS
1. UNFOUNDED
2. PNL
3. OTHER
4. CLEARED
5. EXCEPT CLEARED

24. DATE CLEARED 04/28/99

25. OFFENSE TYPE
1. ADULT NA
2. JUVENILE
3. UNKNOWN

39. (CODE S-SUSPECT W-WITNESS V-VICTIM O-OTHER)	40. NAME-LAST	FIRST	MI	41. D.O.B.	42. ADDRESS	43. TELEPHONE
0	[REDACTED]	[REDACTED]	[REDACTED]	[REDACTED]	[REDACTED]	[REDACTED]
0	PELOQUIN	SUSAN	C	[REDACTED]	Eisner Ave, Sheboygan	[REDACTED]

04/24/99 @ 1115 Hrs.: I, Deputy Colborn, was assigned this incident by MTSO Dispatch. Preliminary information received was that while operating her vehicle north on STH 42, the complainant had observed a black Chevy Blazer, unknown registration, with a damaged grille.

This caller, who identified herself as [REDACTED], stated that the vehicle was in Sheboygan Co. on STH 42.

I recontacted [REDACTED] at her residence on [REDACTED]. [REDACTED] stated the vehicle was in the vicinity of Dairyland Dr. on STH 42. [REDACTED] stated that the passenger side portion of the grille was broken out and that she believed the vehicle was for sale.

I did respond to STH 42 in the vicinity of Dairyland Dr. in Sheboygan Co. where I located this vehicle. I observed this vehicle to bear WI RP NSAS769. I further observed a small portion of the grille to be broken out, however, there was no sheet metal damage whatsoever. The hood and fender was intact as was the bumper. Also, the windshield was free of any damage. Also, it appeared that the radiator upper support and fan shroud were in place and not damaged.

I then made contact with SUSAN PELOQUIN who identified herself as the girlfriend of the owner. SUSAN stated that her boyfriend had damaged the grille of the Blazer while ice fishing and apparently the vehicle fell through the ice.

Due to the fact that the vehicle is absent of any sheet metal damage and/or windshield damage and only a small portion of the grille is broken out of the front of the vehicle, I do not believe this vehicle to be the suspect vehicle for Incident #S99-00242.

No further action taken at this time.

A copy of this incident to be forwarded to Incident Commander, Lt. Bushman and Deputy Raube for entry into the FBI Quick Start Program. AColborn /naf

S99 No 032

45. IF COMPLAINANT DIFFERENT THEN CALLER, ENTER NAME, ADDRESS, D.O.B., TELEPHONE.

46. IF CODE O (OTHER) IS USED IN FIELD #39, EXPLAIN.

INCIDENT REPORT: NOTE: IF SECTION 22 ABOVE HAS NUMBER 4 CHECKED, DO NOT GO BEYOND THIS LINE WITHOUT RECORDS SECTION BEING ADVISED, OR NO RECORD ENTRIES WILL BE MADE BELOW THIS LINE.

PROPERTY VALUE	26. PROPERTY	A. CURRENCY	B. JEWELRY	C. FURS CLOTHING	D. VEHICLE (LOCAL)	E. OFFICE EQUIPMENT	F. RADIO, TV CAMERAS	G. FIREARMS	H. HOUSE-HOLD GOODS
	STOLEN	\$	\$	\$	\$	\$	\$	\$	\$
	RECOVERED	\$	\$	\$	\$	\$	\$	\$	\$
	26. PROPERTY	I. CONSUM-ABLES	J. LIVESTOCK	K. DRUGS	L. MARINE ITEMS	M. CONSTRUCTION ITEMS	N. LAWN AND GARDEN	O. SPORTING GOODS	P. MISC BICYCLE
	STOLEN	\$	\$	\$	\$	\$	\$	\$	\$
	RECOVERED	\$	\$	\$	\$	\$	\$	\$	\$

27. PROPERTY RECOVERED: LOCALLY _____ OTHER JURISDICTION _____ (INSERT O OR L)

PROPERTY ITEMIZATION	PROPERTY STOLEN/RECOVERED ITEMIZATION, USE THE FOLLOWING FORMAT				
	28. QUANTITY	29. ARTICLE NAME	30. BRAND NAME	31. SERIAL NUMBER	32. CODE
					S R <input type="checkbox"/> <input type="checkbox"/>
					S R <input type="checkbox"/> <input type="checkbox"/>
					S R <input type="checkbox"/> <input type="checkbox"/>
					S R <input type="checkbox"/> <input type="checkbox"/>
					S R <input type="checkbox"/> <input type="checkbox"/>

33. PROPERTY DAMAGE AMOUNT \$ _____

34. INSURANCE COMPANY _____

35. OFFICER ASSAULTED Y N

36. ARSON Y N

37. STRUCTURE CODE _____

38. DAMAGE \$ _____

	ENTERED	CANCELLED
47. CIB	<input type="checkbox"/>	<input type="checkbox"/>
NCIC	<input type="checkbox"/>	<input type="checkbox"/>
OTHER BROADCAST	<input type="checkbox"/>	<input type="checkbox"/>

48. TOTAL AMOUNT PROPERTY STOLEN \$ _____

49. TOTAL AMOUNT PROPERTY RECOVERED \$ _____

50. IS REPORT CONTINUED? YES NO

51. CAUTION INDICATORS, ATLS ETC.

52. DATA PROCESS INFORMATION:

COMPUTER ENTERED DATE 15/20/99
 MICROFILM INDEXED INITIAL KS

53. FILE APPROVAL

BY OK DATE 04/28/99

IS CASE CLASSIFICATION CORRECT? N
 IF N HAS CORRECTION BEEN MADE? N

1. CASE # **S99 N~~o~~ 03267** | 2. CLASSIFICATION **631011** | 3. CENSUS **141911**

4. INCIDENT **CS/S99-00242**
 5. INCIDENT LOCATION **CR**
 6. NAME - LAST - FIRST - MI **ANONY (2)** | 7. D.O.B. _____
 8. ADDRESS _____ | 9. TX-HOME _____
 11. CITY _____ STATE _____ ZIP _____ | 10. TX-BUSINESS _____

12. DETAILS
TRUCK IN YARD AT 7710 HWY B
TWO RIVERS, DAMAGE TO FRONT
END AND GRILL.
PLATE # BA18984

04-25-99 1940

14. REC'D	15. DISP	16. 10-23	17. 10-24
13. DAY			
SUN 1	THU 5		
MON 2	FRI 6		
TUE 3	SAT 7		
WED 4			

MANITOWOC COUNTY SHERIFF INCIDENT CARD	
18. ASSIGNED INFORMATION	91811
COLBORN	41312
19. REC. BY 939	20. DIS. BY 939
21. HOW REC'D. 1. 911 2. POLICE RADIO 3. PHONE 4. TTY 5. IN PERSON 6. ON VIEW 7. OFF. OFF DUTY 8. C.B. RADIO 9. OTHER 21A.M.O.	22. TYPE OF REPORT 1. INCIDENT 2. ACCIDENT 3. CITATION 4. NONE 23. STATUS 1. UNFOUNDED 2. PNL 3. OTHER 4. CLEARED 5. EXCEPT CLEARED 24. DATE CLEARED 04/30/99 25. OFFENSE TYPE 1. ADULT <input type="checkbox"/> NA <input checked="" type="checkbox"/> 2. JUVENILE <input type="checkbox"/> 3. UNKNOWN <input type="checkbox"/>

39. (CODE S-SUSPECT W-WITNESS V-VICTIM O-OTHER)						
CODE	40. NAME-LAST	FIRST	MI	41. D.O.B.	42. ADDRESS	43. TELEPHONE
O	Golen Robert W.	00146		██████████	██████████ CTH B, Two Rivers	

04/25/99 @ 1940 Hrs.: I, Deputy Colborn, was assigned this incident. Preliminary information received from MTSO Dispatch was that an anonymous caller had stated that a Chevy truck with front-end damage was observed parked at a residence at ██████ CTH B.

I did respond to ██████ CTH B where I observed a Black Chevy or GMC full-sized 4-wheel drive pickup truck parked. This truck did not have any RP on it. The truck was also missing the drivers door.

I did observe the vehicle ID number to be ██████████. A check through WI DOT revealed that this VIN number belonged on a 1979 Chevrolet pickup truck. I did observe the grille in the truck to be emblazoned with the logo, "GMC."

I did make contact with the owner who states the truck has not been on the highway in over 2 years. The owner states he uses the truck for, "running around in the woods and picking up firewood."

I did observe the windshield on the truck to be cracked but not shattered. I further observed the front bumper to be bent and some sheet metal damage but it did not appear to be fresh damage. I further observed the grille to not be damaged to the point where the center emblem was missing.

I further observed the tires on the truck to be almost bald and a larger, more aggressive tread than the tire pattern left by the suspect vehicle for Incident S99-00242. At this time I do not believe that this vehicle was involved in Incident S99-00242.

No further action taken at this time. A copy of this report to be directed to Incident Commander Lt. Bushman and Deputy Raube for entry into the FBI Quick Start Computer Program.
 AColborn /paf

[Handwritten signature]

S99 N~~o~~ 03267

45. IF COMPLAINANT DIFFERENT THEN CALLER, ENTER NAME, ADDRESS, D.O.B., TELEPHONE.

46. IF CODE O (OTHER) IS USED IN FIELD #39, EXPLAIN.

INCIDENT REPORT: NOTE: IF SECTION 22 ABOVE HAS NUMBER 4 CHECKED, DO NOT GO BEYOND THIS LINE WITHOUT RECORDS SECTION BEING ADVISED, OR NO RECORD ENTRIES WILL BE MADE BELOW THIS LINE.

PROPERTY VALUE	26. PROPERTY	A. CURRENCY	B. JEWELRY	C. FURS CLOTHING	D. VEHICLE (LOCAL)	E. OFFICE EQUIPMENT	F. RADIO, TV CAMERAS	G. FIREARMS	H. HOUSEHOLD GOODS
	STOLEN	\$	\$	\$	\$	\$	\$	\$	\$
	RECOVERED	\$	\$	\$	\$	\$	\$	\$	\$
	26. PROPERTY	I. CONSUMABLES	J. LIVESTOCK	K. DRUGS	L. MARINE ITEMS	M. CONSTRUCTION ITEMS	N. LAWN AND GARDEN	O. SPORTING GOODS	P. MISC BICYCLE
	STOLEN	\$	\$	\$	\$	\$	\$	\$	\$
	RECOVERED	\$	\$	\$	\$	\$	\$	\$	\$

27. PROPERTY RECOVERED: LOCALLY ____ OTHER JURISDICTION ____ (INSERT O OR L)

PROPERTY ITEMIZATION	PROPERTY STOLEN/RECOVERED ITEMIZATION, USE THE FOLLOWING FORMAT				
	28. QUANTITY	29. ARTICLE NAME	30. BRAND NAME	31. SERIAL NUMBER	32. CODE
					S R <input type="checkbox"/> <input type="checkbox"/>
					S R <input type="checkbox"/> <input type="checkbox"/>
					S R <input type="checkbox"/> <input type="checkbox"/>
					S R <input type="checkbox"/> <input type="checkbox"/>
					S R <input type="checkbox"/> <input type="checkbox"/>

33. PROPERTY DAMAGE AMOUNT \$ _____ 34. INSURANCE COMPANY _____

35. OFFICER ASSAULTED Y N 36. ARSON Y N 37. STRUCTURE CODE _____ 38. DAMAGE \$ _____

47. CIB	ENTERED	CANCELLED	48. TOTAL AMOUNT PROPERTY STOLEN \$ _____
NCIC	<input type="checkbox"/>	<input type="checkbox"/>	
OTHER BROADCAST	<input type="checkbox"/>	<input type="checkbox"/>	
			49. TOTAL AMOUNT PROPERTY RECOVERED \$ _____

50. IS REPORT CONTINUED? YES NO 51. CAUTION INDICATORS, ATLS ETC.

52. DATA PROCESS INFORMATION:

COMPUTER ENTERED DATE 10 20 99

MICROFILM INDEXED INITIAL AS

IS CASE CLASSIFICATION CORRECT? Y N
IF N HAS CORRECTION BEEN MADE? Y N

53. FILE APPROVAL
BY [Signature] DATE 10 20 99

1. CASE # S99 No 03308 2. CLASSIFICATION 639.11 3. CENSUS 52000

4. INCIDENT CS 599-00242

5. INCIDENT LOCATION [REDACTED]

6. NAME - LAST - FIRST - MI 7. D.O.B. Anonymous

8. ADDRESS 9. TX-HOME

11. CITY STATE ZIP 10. TX-BUSINESS

12. DETAILS
 Caller saw a brown van with "3 Amigos" on it and RP # BK 16677 with broken grill and damage to headlight on drivers side. (See attached)

1449
 0427/99
 14
 15
 16
 17
 13. DAY
 SUN 1 THU 5
 MON 2 FRI 6
 TUE 3 SAT 7
 WED 4

MANITOWOC COUNTY SHERIFF INCIDENT CARD

8. ASSIGNED
 KULLMAN 8141
 TRAD

19. REC. BY 925 20. DIS. BY
 21. HOW REC'D.
 1. 911
 2. POLICE RADIO
 3. PHONE
 4. TTY
 5. IN PERSON
 6. ON VIEW
 7. OFF. OFF DUTY
 8. C.B. RADIO
 9. OTHER
 21A. M.O.
 22. TYPE OF REPORT
 1. INCIDENT
 2. ACCIDENT
 3. CITATION
 4. NONE
 23. STATUS
 1. UNFOUNDED
 2. PNL
 3. OTHER
 4. CLEARED
 5. EXCEPT CLEARED
 24. DATE CLEARED 04/20/99
 25. OFFENSE TYPE
 1. ADULT NA
 2. JUVENILE
 3. UNKNOWN

39. (CODE S-SUSPECT W-WITNESS V-VICTIM O-OTHER)				42. ADDRESS		43. TELEPHONE
CODE	40. NAME-LAST	FIRST	MI	41. D.O.B.		
0	3 AMIGOS	171494			29TH ST. TWO RIVERS	
	BUSINESS:				WASHINGTON ST. MTWC	

04/26/99 0240hrs Request made of Two Rivers PD to followup and obtain description and explanation of damages.
 0300hrs Area was checked, truck not around, only two vehicles with car registration that are not a match. TR will check back later in the day. M.J. Bushman
 05/13/99 Contact made by leaving message on TR Shift Commander answering machine.
 05/14/99 Contact by phone with Off. Walters. He talked with a 40 year old woman at [REDACTED] 29th St. TR. The van in question is very rarely kept at this address. It usually stays at the Three Amigos on Washington St. Mtwc. Her husband is a silent partner who seldom operate the vehicle which is used to p/u supplies. Apparently there have been three stops prior to Off. Walters, MTSO did not get a report back.
 05/14/99 2130hrs attempt to locate not in parking lot.
 05/15/99 0315hrs attempt to locate, vehicle parked in the parking lot behind 3 Amigos. Damage noted as listed above. An 18x10 inch pc of grille in front of the driver and pc's of the headlamp assembly door are missing. No damage to any sheet metal above or below including the bumper, grille trim, hood or windshield. It does not appear as if anything had been repaired within last few months. Grille design not consistent with pc's found a H&R scene. This would not be the vehicle. Close out. M.J. Bushman

45. IF COMPLAINANT DIFFERENT THEN CALLER, ENTER NAME, ADDRESS, D.O.B., TELEPHONE.

46. IF CODE O (OTHER) IS USED IN FIELD #39, EXPLAIN.

INCIDENT REPORT: NOTE: IF SECTION 22 ABOVE HAS NUMBER 4 CHECKED, DO NOT GO BEYOND THIS LINE WITHOUT RECORDS SECTION BEING ADVISED, OR NO RECORD ENTRIES WILL BE MADE BELOW THIS LINE.

PROPERTY VALUE	26. PROPERTY	A. CURRENCY	B. JEWELRY	C. FURS CLOTHING	D. VEHICLE (LOCAL)	E. OFFICE EQUIPMENT	F. RADIO, TV CAMERAS	G. FIREARMS	H. HOUSEHOLD GOODS
	STOLEN	\$	\$	\$	\$	\$	\$	\$	\$
	RECOVERED	\$	\$	\$	\$	\$	\$	\$	\$
	26. PROPERTY	I. CONSUMABLES	J. LIVESTOCK	K. DRUGS	L. MARINE ITEMS	M. CONSTRUCTION ITEMS	N. LAWN AND GARDEN	O. SPORTING GOODS	P. MISC BICYCLE
	STOLEN	\$	\$	\$	\$	\$	\$	\$	\$
	RECOVERED	\$	\$	\$	\$	\$	\$	\$	\$

27. PROPERTY RECOVERED: LOCALLY _____ OTHER JURISDICTION _____ (INSERT O OR L)

PROPERTY ITEMIZATION	PROPERTY STOLEN/RECOVERED ITEMIZATION, USE THE FOLLOWING FORMAT				
	28. QUANTITY	29. ARTICLE NAME	30. BRAND NAME	31. SERIAL NUMBER	
					S <input type="checkbox"/> R <input type="checkbox"/>
					S <input type="checkbox"/> R <input type="checkbox"/>
					S <input type="checkbox"/> R <input type="checkbox"/>
					S <input type="checkbox"/> R <input type="checkbox"/>
					S <input type="checkbox"/> R <input type="checkbox"/>

33. PROPERTY DAMAGE AMOUNT \$ _____

34. INSURANCE COMPANY _____

35. OFFICER ASSAULTED Y N

36. ARSON Y N

37. STRUCTURE CODE _____

38. DAMAGE \$ _____

47. CIB ENTERED CANCELLED
 NCIC
 OTHER BROADCAST

48. TOTAL AMOUNT PROPERTY STOLEN \$ _____

49. TOTAL AMOUNT PROPERTY RECOVERED \$ _____

50. IS REPORT CONTINUED? YES NO

51. CAUTION INDICATORS, ATLS ETC.

52. DATA PROCESS INFORMATION:

COMPUTER ENTERED DATE 10/29/99
 MICROFILM INDEXED INITIAL JS

53. FILE APPROVAL

IS CASE CLASSIFICATION CORRECT? Y N
 IF N HAS CORRECTION BEEN MADE? Y N

BY JK DATE 10/20/99

1. CASE # **S99 No 03311** 2. CLASSIFICATION **6.310.11** 3. CENSUS **5.210.08**

4. INCIDENT **CS/S99-00242**

5. INCIDENT LOCATION

6. NAME - LAST - FIRST - MI **Anonymous 2** 7. D.O.B.

8. ADDRESS 9. TX-HOME

11. CITY STATE ZIP 10 TX-BUSINESS

12. DETAILS **See Attached.**

04/27/99 1610hrs

MANITOWOC COUNTY SHERIFF INCIDENT CARD			
18. ASSIGNED MBO		9/21/9	
19. REC. BY 935	20. DIS. BY	22. TYPE OF REPORT ① INCIDENT ② ACCIDENT ③ CITATION ④ NONE	
21. HOW REC'D. 1. 911 2. POLICE RADIO ③ PHONE 4. TTY 5. IN PERSON 6. ON VIEW 7. OFF. OFF DUTY 8. C.B. RADIO 9. OTHER		23. STATUS 1. UNFOUNDED 2. PNL ③ OTHER 4. CLEARED 5. EXCEPT CLEARED	
13. DAY SUN 1 THU 5 MON 2 FRI 6 ③ TUE 3 SAT 7 WED 4		24. DATE CLEARED 04/30/99	
21A. M.O.		25. OFFENSE TYPE 1. ADULT <input type="checkbox"/> NA <input type="checkbox"/> 2. JUVENILE <input type="checkbox"/> 3. UNKNOWN <input type="checkbox"/>	

39. (CODE S-SUSPECT W-WITNESS V-VICTIM O-OTHER)						
CODE	40. NAME - LAST	FIRST	MI	41. D.O.B.	42. ADDRESS	43. TELEPHONE
0	EISENSCHINK	DAVID	853	D	Carstens Lake Rd. Valders	
0	OTTO	DAVID		A	Otto Lane, Valders	

04-27-99 @ 1900 hrs.: Upon arrival to HQ to tour of duty, dispatcher called to my attention that there were several new Crimestopper reports. On this particular incident, the complainant reports a Chevrolet truck with right side grill damage parked two miles back by a woods on a hill off of Fischer Rd. south of English Lake Rd. The suspect veh. would be a two-toned 80's Chevrolet truck with RP# BD78485 expiring in 1991. The complainant believes the truck belongs to a DAVID EISENSCHINK.

2200 hrs.: I, Lt. Bushman, noted that the land at the Fischer Road belongs to OTTO DAIRY FARMS. Contact was made with DAVID OTTO, one of the owners of the property. I advised him the reason for my presence on the farm this evening and he stated that there is an older model Chevrolet pickup truck parked on the OTTO property at the end of the dirt road that leads south of Fischer Rd. onto the OTTO family farm. The veh. is owned by DAVID EISENSCHINK. Apparently EISENSCHINK spoke with the senior member of the OTTO family stating that he was intending to use the truck to remove some firewood in a piece of land that he owns. Approx. several years ago, DAVID OTTO stated he sold 65 acres of swamp and woods to DAVID EISENSCHINK who has easement to enter the property. DAVID OTTO stated that officer was welcome to drive down on the lane and check the veh. out.

The veh. in question fits the description that is given above by the complainant. Registration does not come back through the DOT as it is expired too long. There was no VIN# available in the windshield or in the door post. It appears to have been removed. The veh. is not road worthy, there are no tail lights in the back, only one plate to the front, and the vehicle's general condition is very poor. It had been a pickup truck with the box removed and a flat deck placed on the back; however, in very poor condition. The hood is buckled; however, impact point is unknown and there is approx. 4 x 8" square of grill missing from the right front area. Also the left front fender has extensive damage as if the veh. made contact with extremely sturdy such as a building or another heavy-duty vehicle. All damage is extremely rusty and there is no other damage on the veh. indicating that it may be involved in complaint #S99-00242. The rubber on the veh. is in poor shape and not consistent with the suspect veh. There is no consistent damage beyond the small piece of grill work which would be similar to the suspect veh. This is not the veh. we are looking for. Incident can be closed. MJBushman klf

S99-03311-1

45. IF COMPLAINANT DIFFERENT THEN CALLER, ENTER NAME, ADDRESS, D.O.B., TELEPHONE.

46. IF CODE O (OTHER) IS USED IN FIELD #39, EXPLAIN.

INCIDENT REPORT: NOTE: IF SECTION 22 ABOVE HAS NUMBER 4 CHECKED, DO NOT GO BEYOND THIS LINE WITHOUT RECORDS SECTION BEING ADVISED, OR NO RECORD ENTRIES WILL BE MADE BELOW THIS LINE.

PROPERTY VALUE	26. PROPERTY	A. CURRENCY	B. JEWELRY	C. FURS CLOTHING	D. VEHICLE (LOCAL)	E. OFFICE EQUIPMENT	F. RADIO, TV CAMERAS	G. FIREARMS	H. HOUSE-HOLD GOODS
	STOLEN	\$	\$	\$	\$	\$	\$	\$	\$
	RECOVERED	\$	\$	\$	\$	\$	\$	\$	\$
	26. PROPERTY	I. CONSUM-ABLES	J. LIVESTOCK	K. DRUGS	L. MARINE ITEMS	M. CONSTRUCTION ITEMS	N. LAWN AND GARDEN	O. SPORTING GOODS	P. MISC BICYCLE
	STOLEN	\$	\$	\$	\$	\$	\$	\$	\$
	RECOVERED	\$	\$	\$	\$	\$	\$	\$	\$

27. PROPERTY RECOVERED: LOCALLY _____ OTHER JURISDICTION _____ (INSERT O OR L)

PROPERTY ITEMIZATION	PROPERTY STOLEN/RECOVERED ITEMIZATION, USE THE FOLLOWING FORMAT				
	28. QUANTITY	29. ARTICLE NAME	30. BRAND NAME	31. SERIAL NUMBER	32. CODE
					S R <input type="checkbox"/> <input type="checkbox"/>
					S R <input type="checkbox"/> <input type="checkbox"/>
					S R <input type="checkbox"/> <input type="checkbox"/>
					S R <input type="checkbox"/> <input type="checkbox"/>

33. PROPERTY DAMAGE AMOUNT \$ _____

34. INSURANCE COMPANY _____

35. OFFICER ASSAULTED Y N

36. ARSON Y N

37. STRUCTURE CODE _____ 38. DAMAGE \$ _____

47. CIB ENTERED CANCELLED
 NCIC
 OTHER BROADCAST

48. TOTAL AMOUNT PROPERTY STOLEN \$ _____

49. TOTAL AMOUNT PROPERTY RECOVERED \$ _____

50. IS REPORT CONTINUED? YES NO

51. CAUTION INDICATORS, ATLS ETC.

52. DATA PROCESS INFORMATION:

COMPUTER ENTERED DATE 16 09 99
 MICROFILM INDEXED INITIAL AS

53. FILE APPROVAL

IS CASE CLASSIFICATION CORRECT? Y N
 IF N HAS CORRECTION BEEN MADE? Y N

BY [Signature] DATE 01/30/99

1. CASE # S99 No 03313 | 2. CLASSIFICATION 10.310.11 | 3. CENSUS 5,210,000

4. INCIDENT CS / S99-00242

5. INCIDENT LOCATION [REDACTED] WASHINGTON ST.

6. NAME - LAST - FIRST - MI ANONY. (2) | 7. D.O.B.

8. ADDRESS | 9. TX-HOME

11. CITY STATE ZIP | 10. TX-BUSINESS

12. DETAILS See Attached

1728
04-27-99

14. REC'D.	15. DISP	16. 10-23	17. 10-24
13. DAY			
SUN 1	THU 5		
MON 2	FRI 6		
<u>TUE 3</u>	SAT 7		
WED 4			

MANITOWOC COUNTY SHERIFF
INCIDENT CARD

18. ASSIGNED MTSO 9129

FREIBOTH 3116

19. REC. BY 938 | 20. DIS. BY 938 | 22. TYPE OF REPORT (1) INCIDENT

21. HOW REC'D. (3) PHONE | 23. STATUS (3) OTHER

24. DATE CLEARED 042899

25. OFFENSE TYPE (1) ADULT () NA () () JUVENILE () () UNKNOWN ()

39. (CODE S-SUSPECT W-WITNESS V-VICTIM O-OTHER)				42. ADDRESS		43. TELEPHONE	
CODE	40. NAME-LAST	FIRST	MI	41. D.O.B.			

04/28/99 2120hrs Contact made with the City PD and request for assistance made to have an officer assigned to attempt to locate the Crime Stoppers vehicle. It was overheard on the City's frequency that the damage was not consistent with the suspect vehicle, however a copy of the report will be attached before closing. M.J. Bushman

45. IF COMPLAINANT DIFFERENT THEN CALLER, ENTER NAME, ADDRESS, D.O.B., TELEPHONE.

46. IF CODE O (OTHER) IS USED IN FIELD #39, EXPLAIN.

INCIDENT REPORT: NOTE: IF SECTION 22 ABOVE HAS NUMBER 4 CHECKED, DO NOT GO BEYOND THIS LINE WITHOUT RECORDS SECTION BEING ADVISED, OR NO RECORD ENTRIES WILL BE MADE BELOW THIS LINE.

PROPERTY VALUE	26. PROPERTY	A. CURRENCY	B. JEWELRY	C. FURS CLOTHING	D. VEHICLE (LOCAL)	E. OFFICE EQUIPMENT	F. RADIO, TV CAMERAS	G. FIREARMS	H. HOUSE-HOLD GOODS
	STOLEN	\$	\$	\$	\$	\$	\$	\$	\$
	RECOVERED	\$	\$	\$	\$	\$	\$	\$	\$
	26. PROPERTY	I. CONSUM-ABLES	J. LIVESTOCK	K. DRUGS	L. MARINE ITEMS	M. CONSTRUCTION ITEMS	N. LAWN AND GARDEN	O. SPORTING GOODS	P. MISC BICYCLE
	STOLEN	\$	\$	\$	\$	\$	\$	\$	\$
	RECOVERED	\$	\$	\$	\$	\$	\$	\$	\$

27. PROPERTY RECOVERED: LOCALLY ____ OTHER JURISDICTION ____ (INSERT O OR L)

PROPERTY ITEMIZATION	PROPERTY STOLEN/RECOVERED ITEMIZATION, USE THE FOLLOWING FORMAT				
	28. QUANTITY	29. ARTICLE NAME	30. BRAND NAME	31. SERIAL NUMBER	32. CODE
					S R <input type="checkbox"/> <input type="checkbox"/>
					S R <input type="checkbox"/> <input type="checkbox"/>
					S R <input type="checkbox"/> <input type="checkbox"/>
					S R <input type="checkbox"/> <input type="checkbox"/>

33. PROPERTY DAMAGE AMOUNT \$ _____

34. INSURANCE COMPANY _____

35. OFFICER ASSAULTED Y N

36. ARSON Y N

37. STRUCTURE CODE _____ 38. DAMAGE \$ _____

47. CIB ENTERED CANCELLED
 NCIC
 OTHER BROADCAST

48. TOTAL AMOUNT PROPERTY STOLEN \$ _____

49. TOTAL AMOUNT PROPERTY RECOVERED \$ _____

50. IS REPORT CONTINUED? YES NO

51. CAUTION INDICATORS, ATLS ETC.

52. DATA PROCESS INFORMATION:

COMPUTER ENTERED DATE 16/09/99

MICROFILM INDEXED INITIAL KS

IS CASE CLASSIFICATION CORRECT? Y N
 IF N HAS CORRECTION BEEN MADE? Y N

53. FILE APPROVAL

BY [Signature]

DATE 06/28/99

1. CASE # S99 N~~9~~ 03319 2. CLASSIFICATION 6310.11 3. CENSUS 7,010.00

4. INCIDENT CS / S99-00242
 5. INCIDENT LOCATION Kaukauna
 6. NAME - LAST - FIRST - MI Kaukauna M 24099 7. D.O.B.
 8. ADDRESS
 9. TX-HOME
 11. CITY STATE ZIP 10. TX-BUSINESS

12. DETAILS
 Have a veh in Kaukauna RP AK 91513
 Grayish in color with front end
 grill damage.

04/27/99 1753

MANITOWOC COUNTY SHERIFF
 INCIDENT CARD

18. ASSIGNED
 MTSO 929
 M. Bushman H.H.V

19. REC. BY 935 20. DIS. BY
 21. HOW REC'D.
 1. 911
 2. POLICE RADIO
 3. PHONE
 4. TTY
 5. IN PERSON
 6. ON VIEW
 7. OFF. OFF DUTY
 8. C.B. RADIO
 9. OTHER
 21A. M.O.

22. TYPE OF REPORT
 1. INCIDENT
 2. ACCIDENT
 3. CITATION
 4. NONE
 23. STATUS
 1. UNFOUNDED
 2. PNL
 3. OTHER
 4. CLEARED
 5. EXCEPT CLEARED
 24. DATE CLEARED 5/17/00
 25. OFFENSE TYPE
 1. ADULT NA
 2. JUVENILE
 3. UNKNOWN

39. (CODE S-SUSPECT W-WITNESS V-VICTIM O-OTHER)				
CODE	40. NAME-LAST FIRST MI	41. D.O.B.	42. ADDRESS	43. TELEPHONE
O	Vander Wielen, Peter J. 87513		Park Dr. Sherwood	
	Calumet Co. Sheriff		Chilton	Ph: Fax:

04/28/99 0205hrs Calumet Co. Sheriff faxed this report and requested to assist by making contact with the owner and obtain explanation of the damage. M.J. Bushman
 0315hrs Off. Guilles called to advise the vehicle in question is not there at this time. It appears there may be some remodeling going on or their moving. Day shift will followup. MJB
 05/13/99 House has been checked numerous times by Calumet Co. and no one has been found home day or night. There is a dumpster parked outside and the house gutted. Appears as if owner may have run out of money half way through the project; and left area. Off. Wiegert states he will keep checking. M.J. Bushman

45. IF COMPLAINANT DIFFERENT THEN CALLER, ENTER NAME, ADDRESS, D.O.B., TELEPHONE.

46. IF CODE O (OTHER) IS USED IN FIELD #39, EXPLAIN.

INCIDENT REPORT: NOTE: IF SECTION 22 ABOVE HAS NUMBER 4 CHECKED, DO NOT GO BEYOND THIS LINE WITHOUT RECORDS SECTION BEING ADVISED, OR NO RECORD ENTRIES WILL BE MADE BELOW THIS LINE.

PROPERTY VALUE	26. PROPERTY	A. CURRENCY	B. JEWELRY	C. FURS CLOTHING	D. VEHICLE (LOCAL)	E. OFFICE EQUIPMENT	F. RADIO, TV CAMERAS	G. FIREARMS	H. HOUSE-HOLD GOODS
	STOLEN	\$	\$	\$	\$	\$	\$	\$	\$
	RECOVERED	\$	\$	\$	\$	\$	\$	\$	\$
	26. PROPERTY	I. CONSUMABLES	J. LIVESTOCK	K. DRUGS	L. MARINE ITEMS	M. CONSTRUCTION ITEMS	N. LAWN AND GARDEN	O. SPORTING GOODS	P. MISC BICYCLE
	STOLEN	\$	\$	\$	\$	\$	\$	\$	\$
	RECOVERED	\$	\$	\$	\$	\$	\$	\$	\$

27. PROPERTY RECOVERED: LOCALLY _____ OTHER JURISDICTION _____ (INSERT O OR L)

PROPERTY ITEMIZATION	PROPERTY STOLEN/RECOVERED ITEMIZATION, USE THE FOLLOWING FORMAT				
	28. QUANTITY	29. ARTICLE NAME	30. BRAND NAME	31. SERIAL NUMBER	
					S <input type="checkbox"/> R <input type="checkbox"/>
					S <input type="checkbox"/> R <input type="checkbox"/>
					S <input type="checkbox"/> R <input type="checkbox"/>
					S <input type="checkbox"/> R <input type="checkbox"/>

33. PROPERTY DAMAGE AMOUNT \$ _____

34. INSURANCE COMPANY _____

35. OFFICER ASSAULTED Y N 36. ARSON Y N 37. STRUCTURE CODE _____ 38. DAMAGE \$ _____

47. CIB ENTERED CANCELLED
 NCIC
 OTHER BROADCAST

48. TOTAL AMOUNT PROPERTY STOLEN \$ _____

49. TOTAL AMOUNT PROPERTY RECOVERED \$ _____

50. IS REPORT CONTINUED? YES NO

51. CAUTION INDICATORS, ATLS ETC.

52. DATA PROCESS INFORMATION:

COMPUTER ENTERED DATE 15/17/00
 MICROFILM INDEXED INITIAL AS

53. FILE APPROVAL

IS CASE CLASSIFICATION CORRECT? Y N
 IF N HAS CORRECTION BEEN MADE? Y N

BY [Signature] DATE 05/16/00

1. CASE # S99 No 03324 2. CLASSIFICATION 1630.1 3. CENSUS 52000

4. INCIDENT CS S99-06242

5. INCIDENT LOCATION Milwaukee Area

6. NAME- LAST-FIRST-MI [REDACTED] 7. D.O.B. [REDACTED]

9. TX-HOME [REDACTED]

10. TX-BUSINESS [REDACTED]

12. DETAILS
 Comp. saw a billboard in the Kohler area with the H&R information, type vehicle and description of damage. While in the Milwaukee area he saw a matching veh. with registration BH 51-214 white p/u.

13. DAY
 SUN 1 THU 5
 MON 2 FRI 6
 TUE 3 SAT 7
 WED 4

MANITOWOC COUNTY SHERIFF INCIDENT CARD

18. ASSIGNED Bushman 4411
 MTSO 929

19. REC. BY MJB 20. DIS. BY MJB
 21. HOW REC'D.
 1. 911
 2. POLICE RADIO
 3. PHONE
 4. TRY
 5. IN PERSON
 6. ON VIEW
 7. OFF. OFF DUTY
 8. C.B. RADIO
 9. OTHER
 21A. M.O.
 22. TYPE OF REPORT
 1. INCIDENT
 2. ACCIDENT
 3. CITATION
 4. NONE
 23. STATUS
 1. UNFOUNDED
 2. PNL
 3. OTHER
 4. CLEARED
 5. EXCEPT CLEARED
 24. DATE CLEARED 02/01/99
 25. OFFENSE TYPE
 1. ADULT NA
 2. JUVENILE
 3. UNKNOWN

39. CODE	40. NAME- LAST	FIRST	MI	41. D.O.B.	42. ADDRESS	43. TELEPHONE
0	Warner, Cheryl A.	175515			[REDACTED] CTH C, Glenbeulah	Ph: [REDACTED] Fax: [REDACTED]
	Sheboygan Sheriff					
0	WARNER	178558	PHILIP	R	[REDACTED] CTH C Glenbeulah WI	

04/28/99 0248hrs Sheboygan Co. SO requested to assist in locating the above listed vehicle and owner, attempting to obtain explanation of the damage and description.

0334 hrs.: Officer Brill from SBSO was sent to [REDACTED] CTH C and checked on the veh. at that address matching the description above. He located a 1984 Chevrolet full-size pickup, blue in color, WI RP# BH51214 in the driveway. The pickup truck had front and passenger grill damage with approx. 2 ft. of plastic grill missing from the passenger's side quarter panel to the center of the grill. The head light on the Chev. pickup truck was square and the mount was busted off, but the head light was held in place by duct tape. Radiator was pushed in on the passenger's side, which would be located behind the plastic grill, if it was still intact. The hood of the veh. was secured with a red tie-down squared off. The amber and yellow colored Chevrolet symbol was still intact on the grill.

Contact was made with PHILIP R. WARNER and PHILIP stated immediately that he's been stopped more times than he cares to remember by various agencies checking if this veh. was the veh. MTSO was looking for. PHILIP informed Officer Brill that approx. 11/15/98, he was involved with a car vs. deer accident in Ozaukee Co. on STH 57, south of Fredonia 4-way stop intersection. PHILIP WARNER stated that he did file a report with Ozaukee Co. Sheriff's Dept. because he wanted the deer that he had struck. After the contact was made, Officer Brill did contact Lt. Bushman at MTSO and the information forwarded.

04-29-99 @ 2100 hrs.: I, Lt. Bushman, received a faxed copy of the accident report in Ozaukee Co. from the Sheriff's Dept. indicating PHILIP R. WARNER was involved in a car/deer accident on 11/01/98. Accident Report #6957344. This complaint can be closed out.
 MJBushman klf

MJB

S99 No 0332

45. IF COMPLAINANT DIFFERENT THEN CALLER, ENTER NAME, ADDRESS, D.O.B., TELEPHONE.

46. IF CODE O (OTHER) IS USED IN FIELD #39, EXPLAIN.

INCIDENT REPORT: NOTE: IF SECTION 22 ABOVE HAS NUMBER 4 CHECKED, DO NOT GO BEYOND THIS LINE WITHOUT RECORDS SECTION BEING ADVISED, OR NO RECORD ENTRIES WILL BE MADE BELOW THIS LINE.

PROPERTY VALUE	26. PROPERTY	A. CURRENCY	B. JEWELRY	C. FURS CLOTHING	D. VEHICLE (LOCAL)	E. OFFICE EQUIPMENT	F. RADIO, TV CAMERAS	G. FIREARMS	H. HOUSE-HOLD GOODS
	STOLEN	\$	\$	\$	\$	\$	\$	\$	\$
	RECOVERED	\$	\$	\$	\$	\$	\$	\$	\$
	26. PROPERTY	I. CONSUMABLES	J. LIVESTOCK	K. DRUGS	L. MARINE ITEMS	M. CONSTRUCTION ITEMS	N. LAWN AND GARDEN	O. SPORTING GOODS	P. MISC BICYCLE
	STOLEN	\$	\$	\$	\$	\$	\$	\$	\$
	RECOVERED	\$	\$	\$	\$	\$	\$	\$	\$

27. PROPERTY RECOVERED: LOCALLY _____ OTHER JURISDICTION _____ (INSERT O OR L)

PROPERTY ITEMIZATION	PROPERTY STOLEN/RECOVERED ITEMIZATION, USE THE FOLLOWING FORMAT				
	28. QUANTITY	29. ARTICLE NAME	30. BRAND NAME	31. SERIAL NUMBER	32. CODE
					S R <input type="checkbox"/> <input type="checkbox"/>
					S R <input type="checkbox"/> <input type="checkbox"/>
					S R <input type="checkbox"/> <input type="checkbox"/>
					S R <input type="checkbox"/> <input type="checkbox"/>

33. PROPERTY DAMAGE AMOUNT \$ _____ 34. INSURANCE COMPANY _____

35. OFFICER ASSAULTED Y N 36. ARSON Y N 37. STRUCTURE CODE _____ 38. DAMAGE \$ _____

47. CIB ENTERED CANCELLED
 NCIC
 OTHER BROADCAST

48. TOTAL AMOUNT PROPERTY STOLEN \$ _____

49. TOTAL AMOUNT PROPERTY RECOVERED \$ _____

50. IS REPORT CONTINUED? YES NO

51. CAUTION INDICATORS, ATLS ETC.

52. DATA PROCESS INFORMATION:

COMPUTER ENTERED DATE 16/09/99

MICROFILM INDEXED INITIAL AS

IS CASE CLASSIFICATION CORRECT? Y N
 IF N HAS CORRECTION BEEN MADE? Y N

53. FILE APPROVAL

BY GK DATE 06/01/99



SHEBOYGAN COUNTY SHERIFF'S DEPARTMENT
Office of the Sheriff

North 6th Street ★ Sheboygan, WI 53081
PHONE [REDACTED] ★ FAX [REDACTED]

LONI KOENIG
SHERIFF

TIM A. GRASSE
INSPECTOR

DATE: 4-28-99

TOTAL NUMBER OF PAGES: 3 (including coversheet)

TO: LT: RUSHMAN

DEPARTMENT/COMPANY: MANITOWOC CO. SHERIFF

FAX NUMBER: _____

FROM: _____

MESSAGE: RE: INFO ON HIT & RUN

Confidentiality Note:

This information contained in this facsimile message is confidential information, intended only for the use of the individual or entity named above. Any dissemination, distribution or copy of this FAX is prohibited. If you have received this FAX in error, please notify us immediately by telephone, and return the original message to us at the address above via the U.S. Postal Service.

----- NARRATIVE -----

Complaint Nbr: 99-5873
Reporting Ofcr IDS293

Report Date 04-28-1999 07:24:23 Wed
BRILL, SHANNON

Text:

Original: no

Supervisor:

ASSIST OTHER AGENCY

On 04-28-99 at 0334 hours, I, Off. Brill, was sent to [REDACTED] CTH C, for a call of assistance from Manitowoc Co. Sheriff Lt. Bushman to check on a vehicle at that address, which may be related to the hit and run fatality in Manitowoc County. There were no arrests made or citations issued.

Upon arrival at [REDACTED] CTH C, I located a 1984 Chevy full size pickup truck, blue in color, Wisconsin license BH51-214, in the driveway. The pickup truck had front end passenger grill damage with approx. 2' of plastic grill missing from the passenger side quarter panel to the center of the grill. The headlight on the Chevy pickup truck was square and the mount was busted off, but a headlight was on, which was duct taped to the vehicle. The metal plate behind the headlamp assembly and part of the radiator area was pushed in on the passenger side which would be located behind the plastic grill if it was intact. The hood of the vehicle was secured with a red tie down ratcheting strap. Also the grill on this particular model vehicle is squared off. The amber/yellow colored Chevy symbol was intact on the grill of this vehicle. After I checked on the vehicle, I called Manitowoc Co. Sheriff Lt. Bushman and advised him that the vehicle was at this address with the distinguishing characteristics of grill damage. Lt. Bushman asked that I make contact at the residence and have a copy of my report faxed to him.

I made contact with Phillip R. Warner, male/white, DOB [REDACTED], of [REDACTED] CTH C, Glenbeulah, # [REDACTED], and immediately Phillip stated that he's been stopped more times than he cares to remember by various agencies checking if his vehicle was the vehicle Manitowoc Co. Sheriff's Dept. was looking for. Phillip informed me that on approx. 11-15-98 he was involved in a car/deer accident in Ozaukee County on STH 57 just south of the Fredonia 4-way stop intersection. Phillip stated he filed a report with the Ozaukee Co. Sheriff's Dept. because he wanted the deer he had struck. Phillip could not give an exact date of the accident, but stated it was approx. 10 days before Thanksgiving. Phillip also inquired on how he could prevent being stopped constantly by various law enforcement agencies inquiring about his vehicle possibly being involved in the accident in Manitowoc County. I told Phillip he should get copies of the accident report from Ozaukee County to show to any officer which may stop and

APR-28-99 THU 7:33 AM SHEB CO SHERIFF

FAX NO. [REDACTED]

P. 3

of 1998.

I will be completing no further followup investigation at this time.

pss 511170, 513040



SHEBOYGAN COUNTY SHERIFF'S DEPARTMENT
Office of the Sheriff

North 6th Street * Sheboygan, WI 53081
PHONE [REDACTED] * FAX [REDACTED]

LONI KOENIG
SHERIFF

TIM A. GRASSE
INSPECTOR

DATE: 4-28-99

TOTAL NUMBER OF PAGES: 2 (including coversheet)

TO: LT. BUSHMAN

DEPARTMENT/COMPANY: MANITOWOC Co. SHERIFF

FAX NUMBER: [REDACTED] - [REDACTED] - [REDACTED]

FROM: SHEBOYGAN Co. SHERIFF SGT. NASH

MESSAGE: _____

Confidentiality Note:
This information contained in this facsimile message is confidential information, intended only for the use of the individual or entity named above. Any dissemination, distribution or copy of this FAX is prohibited. If you have received this FAX in error, please notify us immediately by telephone, and return the original message to us at the address above via the U.S. Postal Service.

----- VEHICLE -----

Complaint Nb 99-4145
Report Date: 03-20-1999 Sat

VIN: [REDACTED]

Veh Year: 84 Veh Make: CHEV Veh Model: [REDACTED]
Veh Style: PK Veh Color: BLU [REDACTED] Lic Plate: BH51214
Lic State: WI Lic Year: 99 Veh Status: U
Veh Type: [REDACTED] Veh Lgth: [REDACTED]

Hull: [REDACTED] Propulsion: [REDACTED] Boat Name: [REDACTED]

Value: \$0.00 Recovered Value: \$0.00
Recovery Code: [REDACTED] Recovery Date: [REDACTED]
Vehicle Locked: [REDACTED] Keys in Vehicle: [REDACTED]
Property in Vehicle: [REDACTED] Property Tagged: [REDACTED] Property Tag: [REDACTED]

Towed From: [REDACTED]
Towed To: [REDACTED] Towed Date: [REDACTED]
Wrecker: [REDACTED] Reason Towed: [REDACTED]
Released To: [REDACTED] Released Date: [REDACTED]
Released By: [REDACTED] Receipt Nbr: [REDACTED]

Comments: [REDACTED]

----- NARRATIVE -----

Complaint Nbr: 199900004145 Report Date 03-24-1999 11:21:36 Wed
Reporting Ofcr IDS282 JORSCH, BRADLEY

Text: original:m:Officer: Supervisor:
ASSISTED MANITOWOC CO SHERIFF'S DEPT W/ACCIDENT INVESTIGATION

On Saturday, 03/20/99, at 1613 hours I, Deputy Jorsch, was dispatched to [REDACTED] CTH C reference obtaining and verifying information of a vehicle suspected in a hit and run involving the death of another person which occurred in Manitowoc county. As a result of this complaint I observed the vehicle as well as identified the primary operator. This vehicle also fit the description and may have been involved in the hit and run case which Manitowoc county is investigating.

Upon my arrival at [REDACTED] CTH C I observed a 1984 Chevrolet pick-up truck, blue in color, bearing WI/trk/BH51214. Upon a more thorough look at the vehicle, I also observed it had numerous damaged areas on it. Specifically, there was fresh damage to the right front passenger side of the pick-up truck. A portion of the right front passenger side grill had been damaged/missing as well as the headlight was affixed by using duct tape as well as using a thin binding wire. In this area there was also both relatively fresh damage as well as old damage to the front quarter panel. After observing the vehicle I then

[REDACTED], of [REDACTED] CTH C, Glenbeulah WI, 53023, telephone [REDACTED]. In speaking with Philip, I informed Philip I was investigating a hit and run complaint from the county of Manitowoc. I also informed Philip the damage on his vehicle was substantial with the damage which may have occurred from the suspected vehicle striking a person. Philip then informed me he had read the paper and was aware his truck matched the description of the suspect truck, however his truck was not the truck involved. Philip continued by informing me he was involved in a car vs deer accident sometime in the month of November in Ozaukee county. When I asked Philip if he could give me a specific date, Philip could not, however he did inform me the accident had occurred approximately two weeks prior to deer hunting season. When I asked Philip if he had ever traveled in the county of Manitowoc with his blue pick-up truck, Philip informed me he has only been in the county of Manitowoc once in the past two years. While in the county of Manitowoc, Philip had taken his red dump truck to a place called RBA Manufacturing and/or Industry. After taking the necessary information from Philip, I then left Philip's residence without incident.

I'm requesting a copy of this report to be forwarded to Lieutenant Bushman of the Manitowoc County Sheriff's Department as well as CID for assistance.

pss: 511260

APR 29 '99 00:58 TO-

FROM-OZAUKEE COUNTY SHERIFF DEPT.

T-468 P.02/05 F-127

Amended Document On Emergency

OZAUKEE COUNTY SHERIFF'S DEPARTMENT

6957344

Document Number Override

Wisconsin Motor Vehicle Accident Report

INSTRUCTIONS

Please use a Black Ink Pen or #2 Pencil.

Mark Areas as shown:

Correct Mark

Incorrect Marks

Reportable Accident

County: **45** MUNT/WP: **03**

0	0	0
1	1	1
2	2	2
3	3	3
4	4	4
5	5	5
6	6	6
7	7	7
8	8	8
9	9	9

Accident Date

MONTH	DAY	YEAR
Jan		
Feb		
Mar		
Apr		
May		
Jun		
Jul		
Aug		
Sep		
Oct		
Nov		
Dec		

01 98

Time of Accident (Military Time)

HOUR	MIN
0	0
1	1
2	2
3	3
4	4
5	5
6	6
7	7
8	8
9	9
10	10
11	11
12	12
13	13
14	14
15	15
16	16
17	17
18	18
19	19
20	20
21	21
22	22
23	23
24	24

04 45

Total Number

UNITS INJURED/KILLED
0
1
2
3
4
5
6
7
8
9

01

Hit & Run

Government Property

Fire (Narrative)

Photos Taken (Narrative)

Trailer or Towed (Narrative)

Truck or Bus (Last Page)

Load Spillage

Construction Zone

Names Exchanged

Sheet No. Of

1	1
---	---

COPY

ACCIDENT LOCATION

Public Highway, Intersection/Related

Public Highway, Non-Intersection

Parking Lot

Private Property or Road

LATITUDE (GPS) Degrees

ON Estimated

House # _____ Fire # _____ Other _____

Utility # _____ Railroad # _____

Unit Number _____ Unit Type _____

Total Number of Occupants _____

Other _____

Speed Limit _____ OPERATOR Last Name _____ First _____

ADDRESS Street & Number _____

City & State _____ ZIP _____ Phone Number (_____) _____

Driver's License Number _____ Sex _____ Exp. Year _____

Date of Birth _____

On Duty Accident Police EMT/First Responder Fire Fighter Winter Hwy Maintenance

Severity SEAT Position SAFETY Equipment AIRBAG EJECTED

TRAPPED/EXTRICATED 1 Not Applicable 2 Not Trapped 3 Trapped/Not Extricated 4 Unknown 5 Unknown

Vehicle Owner Same Y N

City & State _____ ZIP _____ Phone Number _____

Year of Vehicle _____ Make _____ Model _____ Body Style _____ Color _____

Vehicle ID Number _____

License Plate Number _____ Plate Type _____ State _____ Exp. Year _____

Policy Holder's Name Same _____

Liability Insurance Company _____

Occupant Unit Number _____ NAME Last _____ First _____ M.I. _____ Date of Birth _____ Sex _____ Severity _____ SEAT Position _____ SAFETY Equipment _____ AIRBAG _____

Address Same as Operator EJECTED TRAPPED/EXTRICATED Medical Transport Agency Space

LONGITUDE (GPS)

FROM/AT FROM AT

House # _____ Fire # _____ Other _____

Utility # _____ Railroad # _____

Unit Number _____ Unit Type _____

Total Number of Occupants _____

Other _____

Speed Limit _____ OPERATOR Last Name _____ First _____

ADDRESS Street & Number _____

City & State _____ ZIP _____ Phone Number (_____) _____

Driver's License Number _____ Sex _____ Exp. Year _____

Date of Birth _____

On Duty Accident Police EMT/First Responder Fire Fighter Winter Hwy Maintenance

Severity SEAT Position SAFETY Equipment AIRBAG EJECTED

TRAPPED/EXTRICATED 1 Not Applicable 2 Not Trapped 3 Trapped/Not Extricated 4 Unknown 5 Unknown

Vehicle Owner Same Y N

City & State _____ ZIP _____ Phone Number _____

Year of Vehicle _____ Make _____ Model _____ Body Style _____ Color _____

Vehicle ID Number _____

License Plate Number _____ Plate Type _____ State _____ Exp. Year _____

Policy Holder's Name Same _____

Liability Insurance Company _____

Occupant Unit Number _____ NAME Last _____ First _____ M.I. _____ Date of Birth _____ Sex _____ Severity _____ SEAT Position _____ SAFETY Equipment _____ AIRBAG _____

Address Same as Operator EJECTED TRAPPED/EXTRICATED Medical Transport Agency Space

STH 57

House # _____ Fire # _____ Other _____

Unit Number _____ Unit Type _____

Total Number of Occupants _____

Other _____

Speed Limit _____ OPERATOR Last Name _____ First _____

ADDRESS Street & Number _____

City & State _____ ZIP _____ Phone Number (_____) _____

Driver's License Number _____ Sex _____ Exp. Year _____

Date of Birth _____

On Duty Accident Police EMT/First Responder Fire Fighter Winter Hwy Maintenance

Severity SEAT Position SAFETY Equipment AIRBAG EJECTED

TRAPPED/EXTRICATED 1 Not Applicable 2 Not Trapped 3 Trapped/Not Extricated 4 Unknown 5 Unknown

Vehicle Owner Same Y N

City & State _____ ZIP _____ Phone Number _____

Year of Vehicle _____ Make _____ Model _____ Body Style _____ Color _____

Vehicle ID Number _____

License Plate Number _____ Plate Type _____ State _____ Exp. Year _____

Policy Holder's Name Same _____

Liability Insurance Company _____

Occupant Unit Number _____ NAME Last _____ First _____ M.I. _____ Date of Birth _____ Sex _____ Severity _____ SEAT Position _____ SAFETY Equipment _____ AIRBAG _____

Address Same as Operator EJECTED TRAPPED/EXTRICATED Medical Transport Agency Space

City & State _____ ZIP _____ Phone Number _____

Year of Vehicle _____ Make _____ Model _____ Body Style _____ Color _____

Vehicle ID Number _____

License Plate Number _____ Plate Type _____ State _____ Exp. Year _____

Policy Holder's Name Same _____

Liability Insurance Company _____

Occupant Unit Number _____ NAME Last _____ First _____ M.I. _____ Date of Birth _____ Sex _____ Severity _____ SEAT Position _____ SAFETY Equipment _____ AIRBAG _____

Address Same as Operator EJECTED TRAPPED/EXTRICATED Medical Transport Agency Space

Police No. Please Do Not Write in This Margin

Accident No. 909

Date 04-29-99



Occupant Unit Number	NAME	Last	First	M.I.	Date of Birth	Sex	Severity	SEAT	SAFETY	AIRBAG
	ADDRESS	Street & Number		City & State		ZIP	K N A B C	Position	Equipment	1 Deployed 2 Non Deployed 3 Not Applicable 4 Unknown
Address Same as Operator	Yes No	EJECTED	3 Totally Ejected 4 Partially Ejected 5 Unknown	TRAPPED/ EXTRICATED	1 Not Applicable 2 Not Trapped	3 Trapped/Extricated 4 Trapped/Not Extricated 5 Unknown	Medical Transport	Y N	Agency Space	

Type of Accident

03 First Harmful Event

Most Harmful Event

Unit Number	Unit Number
2 3 4 5	1 2 3 4 5
6 7 8 9 10	11 12 13 14 15

(select one per vehicle)

Collision With Object Not Fixed

- 1 Motor Vehicle in Transport
- 2 Parked Motor Vehicle
- 3 Deer
- 4 Pedalcycle
- 5 Pedestrian
- 6 Railway Train
- 7 Other Animal
- 8 Motor Vehicle in Transport In Other Roadway
- 9 Other Object (Not Fixed)

Collision With Fixed Object

- 10 Traffic Sign Post
- 11 Traffic Signal
- 12 Utility Pole
- 13 Lum. Light Support
- 14 Other Post
- 15 Tree
- 16 Mailbox
- 17 Guardrail Face
- 18 Guardrail End
- 19 Median Barrier
- 20 Bridge Parapet End
- 21 Bridge/Pier/Abut.
- 22 Impact Attenuator
- 23 Overhead Sign Post
- 24 Bridge Rail
- 25 Culvert
- 26 Ditch
- 27 Curb
- 28 Embankment
- 29 Fence
- 30 Other Fixed Object
- 31 Unknown

Non-Collision

- 32 Overtum
- 33 Fire/Explosion
- 34 Immersion
- 35 Jackknife
- 36 Other Non-Collision

Driver Condition

Unit Number	Unit Number
1 2 3 4 5	6 7 8 9 10

Driver Factors (Or Pedestrians)

- 1 Appeared Normal
- 2 Reduced Alertness
- 3 Ability Impaired
- 4 Not Observed

Presence

- 5 Neither Alcohol nor Drugs Present
- 6 Yes—Alcohol Present
- 7 Yes—Drugs Present
- 8 Yes—Alcohol & Drugs Present
- 9 Unknown

Alcohol

AC Value	AC Value
10 Test Not Given	10
11 Test Refused	11
12 Test Given, Alcohol Unknown	12
13 Test Given, No Alcohol Reported	13

Drugs

- 14 Test Not Given
- 15 Test Refused
- 16 Test Given, Drugs Unknown
- 17 Test Given, No Drugs Reported
- 18 Drugs Reported (Specify Below)
- 19 Marijuana
- 20 Cocaine
- 21 Opiates
- 22 Amphetamines
- 23 PCP
- 24 Other Drug Medication
- 25 Type Unknown

Unit #

Pedestrian

Location	Action
1 In Crosswalk	1 Walking not Facing Traffic
2 In Roadway	2 Disregarded Signal
3 Not in Roadway	3 Darting into Road
4 On Sidewalk	4 Dark Clothing
	5 Walking Facing Traffic

Manner of Collision

- 1 No Collision with Motor Vehicle in Transport
- 2 Rear-end
- 3 Head On
- 4 Rear to Rear
- 5 Angle
- 6 Sideswipe, Same Direction
- 7 Sideswipe, Opposite Direction
- 8 Unknown

Unit #

Darken Numbered Area(s) of Vehicle Damage

Extent of Damage

- 0 None
- 10 Undercarriage
- 11 Total (Damage to all Areas)
- 12 Other
- 13 Unknown
- 0 None
- 4 Severe
- 1 Very Minor
- 5 Very Severe
- 2 Minor
- 6 Unknown
- 3 Moderate

Unit #

Darken Numbered Area(s) of Vehicle Damage

Extent of Damage

- 0 None
- 10 Undercarriage
- 11 Total (Damage to all Areas)
- 12 Other
- 13 Unknown
- 0 None
- 4 Severe
- 1 Very Minor
- 5 Very Severe
- 2 Minor
- 6 Unknown
- 3 Moderate

Fixed Object Struck

Unit #	Unit #	Unit #	Unit #

PROPERTY OWNER Last First M.I.

ADDRESS Street & Number

City & State ZIP Phone Number

0001074

Officer's Opinion of Possible Contributing Circumstances

Document Number Override
121

Driver Factors									
Unit Number					Unit Number				
1	2	3	4	5	1	2	3	4	5
6	7	8	9	10	6	7	8	9	10
N/A					N/A				
1	Exceeding Speed Limit								
2	Speed too Fast/Condition								
3	Fail to Yield Right of Way								
4	Inattentive Driving								
5	Following too Close								
6	Improper Turn								
7	Left of Center								
8	Disregarded Traffic Control								
9	Improper Overtaking								
10	Unsafe Backing								
11	Failure to have Control								
12	Driver Condition								
13	Physically Disabled								
14	Other								

Vehicle Factors									
Unit Number					Unit Number				
1	2	3	4	5	1	2	3	4	5
6	7	8	9	10	6	7	8	9	10
N/A					N/A				
1	Brake System				1				
2	Tires				2				
3	Steering System				3				
4	Turn Signals				4				
5	Head Lamps				5				
6	Stop Lamps				6				
7	Tail Lamps				7				
8	Disabled in Prior Accident				8				
9	Other Disabled				9				
10	Mirrors				10				
11	Suspension System				11				
12	Other				12				

Highway Factors									
Unit Number					Unit Number				
1	2	3	4	5	1	2	3	4	5
6	7	8	9	10	6	7	8	9	10
N/A					N/A				
1	Snow, Ice or Wet								
2	Narrow shoulder								
3	Low Shoulder								
4	Soft Shoulder								
5	Loose Gravel								
6	Rough Pavement								
7	Debris from Prior Accident								
8	Other Debris								
9	Sign Obscured or Missing								
10	Narrow Bridge								
11	Construction Zone								
12	Visibility Obscured								
13	Other								

OFFICER INFORMATION

Last Name	First Name	MI
Milbach	Demario	
Law Enforcement Agency Address		
S. Spring St.		
City & State		ZIP
Port Washington, WI.		53074
Phone Number		
Agency #	Enforcement Agency	Officer ID #
120	Ozaukee Sheriff	49

Date Notified			Time Notified (Military Time)		Time Arrived (Military Time)		Date of Report		
MONTH	DAY	YEAR	HOUR	MIN.	HOUR	MIN.	MONTH	DAY	YEAR
Jan							Jan		
Feb	01	98					Feb	01	98
Mar							Mar		
Apr							Apr		
May							May		
June							June		
July							July		
Aug							Aug		
Sept							Sept		
Oct							Oct		
Nov							Nov		
Dec							Dec		

Truck & Bus Accident Information (This Section Must Be Completed for Each Truck or Bus Involved in this Accident.)

When to Use This Section: Did the accident involve...
 Part A
 A truck with at least two axles and six tires? Y N
 A truck with a hazardous materials placard? Y N
 A bus designed to carry 16 or more persons, including the driver? Y N
 STOP! If all the responses to Part A are "NO" do not complete this Truck & Bus Accident Information Section. If there are any "YES" answers, continue to Part B.
 Part B
 Any person who was fatally injured? Y N
 Any injured person requiring transport for immediate medical treatment? Y N
 One or more vehicles that had to be towed from the scene as a result of the accident? Y N
 STOP! If all the responses to Part B are "NO" do not continue. If there are any "YES" answers, please complete this Truck & Bus Accident Information Section...

Hazardous Material Information

- Hazardous Material Class Numbers (1-2digit):
- Hazardous Material "UN" Numbers (4 digit):
- Hazardous Material Placard Displayed? Y N
- Hazardous Cargo was Released? Y N

List the Hazardous Material(s) by name in this box:

 List the Name(s) of Released Hazardous Material(s):

Carrier Information

- Interstate Carrier? Y N
- Carrier Name: 120

Carrier Identification Numbers

US DOT	111	LC
ICC MC		IC
Carrier Address		

Source: Vehicle Side Shipping Papers Trip Manifest Driver Log Book

Vehicle Information

Vehicle Configuration:

SEQUENCE OF EVENTS FOR THIS VEHICLE

- Ran off Road
- Jackknife
- Overtake (Rollover)
- Downhill Runaway
- Cargo Loss or Shift
- Explosion or Fire
- Separation of Units
- Collision involving pedestrian

Gross Vehicle Weight Rating: _____ LBS Total # of Axles: _____

Cargo Body Type:

Collision involving motor vehicle in transp.
 Collision involving parked motor vehicle
 Collision involving train
 Collision involving pedalcycle
 Collision involving animal
 Collision involving fixed object
 Collision involving other object

Printed in U.S.A. GS03 301 5055-200-06-2

CITY OF MANITOWOC POLICE
INTELLIGENCE REPORT

DATE: 4/14/99

- NEW-All known identification of subjects needed

SUBJECTS: _____

Supplemental submission

SOURCE: [REDACTED]

WRITTEN REPORT:

I, Det. Sgt. Swetlik, received a call from a [REDACTED] who informed me that while he was traveling in the Kohler, WI area, he noticed a billboard on the side of the road, which indicated that we are looking for a hit and run vehicle. [REDACTED] informed me that after reading the billboard's information, as far as, what type of damage to look for and the type of vehicle, he did notice one somewhere in the Milwaukee area with damage to the grill. [REDACTED] informed me that he did, indeed, get the license plate number of the vehicle which would be #BH51-214. It should have been on a, possibly white pickup truck. [REDACTED] had no other information to offer at that time.

Det. Swetlik/kmz

Source of Information
-Informant -Investigation -Records -Citizen -Other _____

Evaluation of Source
 A-Reliable B-Usually Reliable C-Fairly Reliable D-Not Usually Reliable E-Unreliable F-Reliability Unknown

Evaluation of Information
 1-Confirmed 2-Probably True 3-Possibly True 4-Doubtfully True 5-Improbable 6-Truth C Be Judg

Criminal Area
-Narcotics -Burglary/Theft -Weapons -Vice -Other _____

1. CASE # S99 No 03377	2. CLASSIFICATION 6310.1	3. CENSUS 5,210,0,0
4. INCIDENT CS See S99-00242		
5. INCIDENT LOCATION S. 26th STR.		
6. NAME- LAST FIRST MI [REDACTED]	7. D.O.B. (59330)	
8. ADDRESS [REDACTED]		9. TX-HOME [REDACTED]
11. CITY [REDACTED]	STATE [REDACTED]	ZIP [REDACTED]
10. TX-BUSINESS [REDACTED]		
12. DETAILS COMPL. OBSERVED '85 or '86 BLK. CHEV. PULL TRK W/ FRT GRILL PARTIALLY OUT. DOES NOT HAVE RP INFO FOR US. / SEE ATTACHED see below		

0715 04-30-99
 0730
 0748
 14. REC'D
 15. DISP
 16. 10-23
 17. 10-24
 13. DAY
 SUN 1 THU 5
 MON 2 FRI 8
 TUE 3 SAT 7
 WED 4

MANITOWOC COUNTY SHERIFF INCIDENT CARD		
18. ASSIGNED MTSO		9219
MTPD (OFFICER. BUCK)		91315
19. REC. BY 930	20. DIS. BY 930	22. TYPE OF REPORT <input checked="" type="checkbox"/> 1. INCIDENT <input type="checkbox"/> 2. ACCIDENT <input type="checkbox"/> 3. CITATION <input type="checkbox"/> 4. NONE
21. HOW REC'D. <input type="checkbox"/> 1. 911 <input checked="" type="checkbox"/> 2. POLICE RADIO <input checked="" type="checkbox"/> 3. PHONE C.S. <input type="checkbox"/> 4. TTY <input type="checkbox"/> 5. IN PERSON <input type="checkbox"/> 6. ON VIEW <input type="checkbox"/> 7. OFF. OFF DUTY <input type="checkbox"/> 8. C.B. RADIO <input type="checkbox"/> 9. OTHER		23. STATUS <input type="checkbox"/> 1. UNFOUNDED <input type="checkbox"/> 2. PNL <input checked="" type="checkbox"/> 3. OTHER <input type="checkbox"/> 4. CLEARED <input type="checkbox"/> 5. EXCEPT CLEARED
24. DATE CLEARED 04/01/99		25. OFFENSE TYPE <input type="checkbox"/> 1. ADULT <input type="checkbox"/> 2. JUVENILE <input type="checkbox"/> 3. UNKNOWN
21A. M.O. [REDACTED]		

39. (CODE S-SUSPECT W-WITNESS V-VICTIM O-OTHER)				41. D.O.B.	42. ADDRESS	43. TELEPHONE
CODE	40. NAME-LAST	FIRST	MI			

0730 hrs. 04/30/99 Per S.C. on duty, sent MTPD officer to location to determine if vehicle is a possible suspect vehicle in S99-00242. DB/930

0748 hr.s 04/30/99 MTPD Officer Buck supplied RP from above described vehicle: BH80615, 10-28 attached. Officer did confirm small amount of front grill damage; but unknown if it conforms to suspect of S99-00242. DB/930 DB

04/30/99 2243hrs Vehicle located on the street at [REDACTED] So. 18th street. Vehicle is an 84 Chev P/U with the entire grille cracked in numerous places. Very few pc's are missing and there does not appear to be any sheet metal damage inside or out. The bumper is pushed backward but damage appears to be very old. The general condition of the vehicle is poor but running. All tires vary in tread design, non match. Close out. M.J. Bushman

S99 No 03377

45. IF COMPLAINANT DIFFERENT THEN CALLER, ENTER NAME, ADDRESS, D.O.B., TELEPHONE.

46. IF CODE O (OTHER) IS USED IN FIELD #39, EXPLAIN.

INCIDENT REPORT: NOTE: IF SECTION 22 ABOVE HAS NUMBER 4 CHECKED, DO NOT GO BEYOND THIS LINE WITHOUT RECORDS SECTION BEING ADVISED, OR NO RECORD ENTRIES WILL BE MADE BELOW THIS LINE.

PROPERTY VALUE	26. PROPERTY	A. CURRENCY	B. JEWELRY	C. FURS CLOTHING	D. VEHICLE (LOCAL)	E. OFFICE EQUIPMENT	F. RADIO, TV CAMERAS	G. FIREARMS	H. HOUSE-HOLD GOODS
	STOLEN	\$	\$	\$	\$	\$	\$	\$	\$
	RECOVERED	\$	\$	\$	\$	\$	\$	\$	\$
	26. PROPERTY	I. CONSUM-ABLES	J. LIVESTOCK	K. DRUGS	L. MARINE ITEMS	M. CONSTRUCTION ITEMS	N. LAWN AND GARDEN	O. SPORTING GOODS	P. MISC BICYCLE
	STOLEN	\$	\$	\$	\$	\$	\$	\$	\$
	RECOVERED	\$	\$	\$	\$	\$	\$	\$	\$

27. PROPERTY RECOVERED: LOCALLY _____ OTHER JURISDICTION _____ (INSERT O OR L)

PROPERTY ITEMIZATION	PROPERTY STOLEN/RECOVERED ITEMIZATION, USE THE FOLLOWING FORMAT				
	28. QUANTITY	29. ARTICLE NAME	30. BRAND NAME	31. SERIAL NUMBER	32. CODE
					S R <input type="checkbox"/> <input type="checkbox"/>
					S R <input type="checkbox"/> <input type="checkbox"/>
					S R <input type="checkbox"/> <input type="checkbox"/>
					S R <input type="checkbox"/> <input type="checkbox"/>

33. PROPERTY DAMAGE AMOUNT \$ _____ 34. INSURANCE COMPANY _____

35. OFFICER ASSAULTED Y N 36. ARSON Y N 37. STRUCTURE CODE _____ 38. DAMAGE \$ _____

47. CIB	ENTERED <input type="checkbox"/>	CANCELLED <input type="checkbox"/>	48. TOTAL AMOUNT PROPERTY STOLEN \$ _____
NCIC	<input type="checkbox"/>	<input type="checkbox"/>	
OTHER BROADCAST	<input type="checkbox"/>	<input type="checkbox"/>	
			49. TOTAL AMOUNT PROPERTY RECOVERED \$ _____

50. IS REPORT CONTINUED? YES NO 51. CAUTION INDICATORS, ATLS ETC.

52. DATA PROCESS INFORMATION:

COMPUTER ENTERED DATE 6/19/99

MICROFILM INDEXED INITIAL AS

IS CASE CLASSIFICATION CORRECT? Y N

IF N HAS CORRECTION BEEN MADE? Y N

53. FILE APPROVAL

BY [Signature] DATE 02/01/99

MCSO 028 1/91

042899.

LT.

MTPD checked on Jeth on the
Crime Stopper. Damage was not
consistent to what we are
looking for.

LYNN

1. CASE # S99 No 03182 | 2. CLASSIFICATION 6310.11 | 3. CENSUS 52100.0

4. INCIDENT CS/S99-00242

5. INCIDENT LOCATION

6. NAME - LAST - FIRST - MI Anonymous | 7. D.O.B.

8. ADDRESS | 9. TX-HOME

11. CITY STATE ZIP | 10. TX-BUSINESS

12. DETAILS See Attached

147
04/22/99

14. REC'D	15. DISP	16. 10-23	17. 10-24
		THU 5	
		FRI 6	
		SAT 7	
		WED 4	

MANITOWOC COUNTY SHERIFF
INCIDENT CARD

18. ASSIGNED MTSO 9/29

19. REC. BY 935 | 20. DIS. BY

21. HOW REC'D.
1. 911
2. POLICE RADIO
3. PHONE
4. TTY
5. IN PERSON
6. ON VIEW
7. OFF. OFF DUTY
8. C.B. RADIO
9. OTHER

22. TYPE OF REPORT
1. INCIDENT
2. ACCIDENT
3. CITATION
4. NONE

23. STATUS
1. UNFOUNDED
2. PNL
3. OTHER
4. CLEARED
5. EXCEPT CLEARED

24. DATE CLEARED 10/01/99

25. OFFENSE TYPE
1. ADULT NA
2. JUVENILE
3. UNKNOWN

39. (CODE S-SUSPECT W-WITNESS V-VICTIM O-OTHER)						
CODE	40. NAME-LAST	FIRST	MI	41. D.O.B.	42. ADDRESS	43. TELEPHONE

05/07/99 Very early in the investigation all Edward A. Dehne's vehicles had been checked. The one vehicle closest to the suspect vehicle is the 85 Chev P/U with registration 2953F Farm. It is a 4WD over height with large aggressive snow/mud tires white and red in color, with a customized after market grille, no damage.

Currently it is parked on his farm property and has the engine removed with registration 39303F Farm plate.

Without more that a hunch contact should not be made again. close out. M.J. Bushma *MJB*

1. CASE # S99 No 03406 2. CLASSIFICATION 630.11 3. CENSUS 6.0000

4. INCIDENT CS-S99-00242

5. INCIDENT LOCATION Cty JJ & S

6. NAME - LAST - FIRST - MI Anon 7. D.O.B.

8. ADDRESS 9. TX-HOME

11. CITY STATE ZIP 10. TX-BUSINESS

12. DETAILS
 No plate, Black Chevy,
 unknown year, Has a brush
 guard & broken light

4-30-99 142

14. REC'D	15. DISP	16. 10-23	17. 10-24
13. DAY			
SUN 1	THU 5		
MON 2	FRI 6		
TUE 3	SAT 7		
WED 4			

MANITOWOC COUNTY SHERIFF
INCIDENT CARD

18. ASSIGNED info 981

19. REC. BY OAA 20. DIS. BY

21. HOW REC'D.
 1. 911
 2. POLICE RADIO
 3. PHONE
 4. TTY
 5. IN PERSON
 6. ON VIEW
 7. OFF. OFF DUTY
 8. C.B. RADIO
 9. OTHER

22. TYPE OF REPORT
 INCIDENT
 ACCIDENT
 CITATION
 NONE

23. STATUS
 1. UNFOUNDED
 2. PNL
 OTHER
 4. CLEARED
 5. EXCEPT CLEARED

24. DATE CLEARED 06/01/99

25. OFFENSE TYPE
 1. ADULT NA
 2. JUVENILE
 3. UNKNOWN

21A. M.O.

39. (CODE S-SUSPECT W-WITNESS V-VICTIM O-OTHER)	40. NAME-LAST	FIRST	MI	41. D.O.B.	42. ADDRESS	43. TELEPHONE
0	Wilker Jeffrey S.	20927			E Taus. Rd, Whitelaw	

05/07/99 This vehicle was parked at [redacted] Taus Rd. and no one was home when Officer attempted contact. Vehicle was checked and had Registration 66621F Farm plate. Vin number matched. There was minor running and headlamp damage on the passenger side. No other damage noted, nothing appeared to have been repaired. Tires were large and diferent from front to rear, and have been on the vehicle a long time. Vehicle does not match the suspect vehicle. 2145 hrs contact made by phone with the complainant who stated she is a [redacted] and had seen the suspect vehicle listed above near CTH JJ and CTH S as it came up rapidly behind her. No plate obtained. Much later she saw what looked like the same vehicle parked in a yard on Reifs Mills Rd. West of CTH J, 2nd farm on the Southside.

05/08/99 Off. Joe Keil located the Black Chev. Blazer at farm above. It bear registration FFX 387 (94) and looks like it has not been driven in a very long time. No damage, tires flat, interior full of old tires. Close out. M.J. Bushman

45. IF COMPLAINANT DIFFERENT THEN CALLER, ENTER NAME, ADDRESS, D.O.B., TELEPHONE.

46. IF CODE O (OTHER) IS USED IN FIELD #39, EXPLAIN.

INCIDENT REPORT: NOTE: IF SECTION 22 ABOVE HAS NUMBER 4 CHECKED, DO NOT GO BEYOND THIS LINE WITHOUT RECORDS SECTION BEING ADVISED, OR NO RECORD ENTRIES WILL BE MADE BELOW THIS LINE.

PROPERTY VALUE	26. PROPERTY	A. CURRENCY	B. JEWELRY	C. FURS CLOTHING	D. VEHICLE (LOCAL)	E. OFFICE EQUIPMENT	F. RADIO, TV CAMERAS	G. FIREARMS	H. HOUSE-HOLD GOODS
	STOLEN	\$	\$	\$	\$	\$	\$	\$	\$
	RECOVERED	\$	\$	\$	\$	\$	\$	\$	\$
	26. PROPERTY	I. CONSUMABLES	J. LIVESTOCK	K. DRUGS	L. MARINE ITEMS	M. CONSTRUCTION ITEMS	N. LAWN AND GARDEN	O. SPORTING GOODS	P. MISC BICYCLE
	STOLEN	\$	\$	\$	\$	\$	\$	\$	\$
	RECOVERED	\$	\$	\$	\$	\$	\$	\$	\$

27. PROPERTY RECOVERED: LOCALLY _____ OTHER JURISDICTION _____ (INSERT O OR L)

PROPERTY ITEMIZATION	PROPERTY STOLEN/RECOVERED ITEMIZATION, USE THE FOLLOWING FORMAT				
	28. QUANTITY	29. ARTICLE NAME	30. BRAND NAME	31. SERIAL NUMBER	32. CODE
					S R <input type="checkbox"/> <input type="checkbox"/>
					S R <input type="checkbox"/> <input type="checkbox"/>
					S R <input type="checkbox"/> <input type="checkbox"/>
					S R <input type="checkbox"/> <input type="checkbox"/>
					S R <input type="checkbox"/> <input type="checkbox"/>

33. PROPERTY DAMAGE AMOUNT \$ _____

34. INSURANCE COMPANY _____

35. OFFICER ASSAULTED Y N

36. ARSON Y N

37. STRUCTURE CODE _____ 38. DAMAGE \$ _____

47. CIB ENTERED CANCELLED
 NCIC
 OTHER BROADCAST

48. TOTAL AMOUNT PROPERTY STOLEN \$ _____

49. TOTAL AMOUNT PROPERTY RECOVERED \$ _____

50. IS REPORT CONTINUED? YES NO

51. CAUTION INDICATORS, ATLS ETC.

52. DATA PROCESS INFORMATION:

COMPUTER ENTERED DATE 1/29/99

MICROFILM INDEXED INITIAL RS

IS CASE CLASSIFICATION CORRECT? Y N
 IF N HAS CORRECTION BEEN MADE? Y N

53. FILE APPROVAL

BY CK

DATE 1/29/99

1. CASE # S99 No 03425 2. CLASSIFICATION 630.1 3. CENSUS 53000

4. INCIDENT CS-399-00242

5. INCIDENT LOCATION Washington near Police Dept.

6. NAME - LAST - FIRST MI 73987 7. D.O.B.

8. ADDRESS [REDACTED] 9. TX-BUSINESS

11. CITY STATE ZIP 10. TX-BUSINESS

12. DETAILS
 Saw dark blue two tone on Washington St. near police dept
 5-1-99 approx 1000 AM. With driver side grill damage.

1047
5-1-99

14. REC'D	15. DISP	16. 10-23	17. 10-24
SUN 1	THU 5	MON 2	FRI 6
TUE 3	SAT 7	WED 4	

MANITOWOC COUNTY SHERIFF INCIDENT CARD

18. ASSIGNED info 981

19. REC. BY 944 20. DIS. BY

21. HOW REC'D.
 1. 911
 2. POLICE RADIO
 3. PHONE
 4. TTY
 5. IN PERSON
 6. ON VIEW
 7. OFF. OFF DUTY
 8. C.B. RADIO
 9. OTHER
 21A. M.O.

22. TYPE OF REPORT
 1. INCIDENT
 2. ACCIDENT
 3. CITATION
 4. NONE

23. STATUS
 1. UNFOUNDED
 2. PNL
 3. OTHER
 4. CLEARED
 5. EXCEPT CLEARED

24. DATE CLEARED 06/01/99

25. OFFENSE TYPE
 1. ADULT NA
 2. JUVENILE
 3. UNKNOWN

39. (CODE S-SUSPECT W-WITNESS V-VICTIM O-OTHER)						
CODE	40. NAME-LAST	FIRST	MI	41. D.O.B.	42. ADDRESS	43. TELEPHONE
O	Dobbs Robert A.	29656			[REDACTED] E. River, Two Rivers	

05/07/99 This vehicle checked prior in S99-01788, close out. M.J. Bushman

45. IF COMPLAINANT DIFFERENT THEN CALLER, ENTER NAME, ADDRESS, D.O.B., TELEPHONE.

46. IF CODE O (OTHER) IS USED IN FIELD #39, EXPLAIN.

INCIDENT REPORT: NOTE: IF SECTION 22 ABOVE HAS NUMBER 4 CHECKED, DO NOT GO BEYOND THIS LINE WITHOUT RECORDS SECTION BEING ADVISED, OR NO RECORD ENTRIES WILL BE MADE BELOW THIS LINE.

PROPERTY VALUE	26. PROPERTY	A. CURRENCY	B. JEWELRY	C. FURS CLOTHING	D. VEHICLE (LOCAL)	E. OFFICE EQUIPMENT	F. RADIO, TV CAMERAS	G. FIREARMS	H. HOUSE-HOLD GOODS
	STOLEN	\$	\$	\$	\$	\$	\$	\$	\$
	RECOVERED	\$	\$	\$	\$	\$	\$	\$	\$
	26. PROPERTY	I. CONSUMABLES	J. LIVESTOCK	K. DRUGS	L. MARINE ITEMS	M. CONSTRUCTION ITEMS	N. LAWN AND GARDEN	O. SPORTING GOODS	P. MISC BICYCLE
	STOLEN	\$	\$	\$	\$	\$	\$	\$	\$
	RECOVERED	\$	\$	\$	\$	\$	\$	\$	\$

27. PROPERTY RECOVERED: LOCALLY _____ OTHER JURISDICTION _____ (INSERT O OR L)

PROPERTY ITEMIZATION	PROPERTY STOLEN/RECOVERED ITEMIZATION, USE THE FOLLOWING FORMAT				
	28. QUANTITY	29. ARTICLE NAME	30. BRAND NAME	31. SERIAL NUMBER	
					S <input type="checkbox"/> R <input type="checkbox"/>
					S <input type="checkbox"/> R <input type="checkbox"/>
					S <input type="checkbox"/> R <input type="checkbox"/>
					S <input type="checkbox"/> R <input type="checkbox"/>
					S <input type="checkbox"/> R <input type="checkbox"/>

33. PROPERTY DAMAGE AMOUNT \$ _____

34. INSURANCE COMPANY _____

35. OFFICER ASSAULTED Y N 36. ARSON Y N 37. STRUCTURE CODE _____ 38. DAMAGE \$ _____

47. CIB ENTERED CANCELLED
 NCIC
 OTHER BROADCAST

48. TOTAL AMOUNT PROPERTY STOLEN \$ _____

49. TOTAL AMOUNT PROPERTY RECOVERED \$ _____

50. IS REPORT CONTINUED? YES NO

51. CAUTION INDICATORS, ATLS ETC.

52. DATA PROCESS INFORMATION:

COMPUTER ENTERED DATE 1/29/99
 MICROFILM INDEXED INITIAL RS

53. FILE APPROVAL

IS CASE CLASSIFICATION CORRECT? N
 IF N HAS CORRECTION BEEN MADE? N

BY PK DATE 1/20/99

1. CASE # S99 N# 03672 2. CLASSIFICATION 63011 3. CENSUS 3.60000

4. INCIDENT CS/599-00242

5. INCIDENT LOCATION [redacted] Mtwc St / Reedsville

6. NAME - LAST - FIRST - MI Anon 7. D.O.B. [redacted]

8. ADDRESS [redacted] 9. TX-HOME [redacted]

11. CITY STATE ZIP 10. TX-BUSINESS [redacted]

12. DETAILS
 Caller spoke to 479 ref
 a red & white Chev Van
 Possibly parked in a garage
 [redacted] Mtwc Street - Reedsville

51099
1645

MANITOWOC COUNTY SHERIFF
INCIDENT CARD

18. ASSIGNED MTSO 9/29

19. REC. BY 926 20. DIS. BY 926

21. HOW REC'D.
 1. 911
 2. POLICE RADIO
 3. PHONE
 4. TTY
 5. IN PERSON
 6. ON VIEW
 7. OFF. OFF DUTY
 8. C.B. RADIO
 9. OTHER

22. TYPE OF REPORT
 1. INCIDENT
 2. ACCIDENT
 3. CITATION
 4. NONE

23. STATUS
 1. UNFOUNDED
 2. PNL
 3. OTHER
 4. CLEARED
 5. EXCEPT CLEARED

24. DATE CLEARED 1/5/700

25. OFFENSE TYPE
 1. ADULT NA
 2. JUVENILE
 3. UNKNOWN

21A. M.O. [redacted]

39. (CODE S-SUSPECT W-WITNESS V-VICTIM O-OTHER)				41. D.O.B.		42. ADDRESS		43. TELEPHONE	
CODE	40. NAME-LAST	FIRST	MI						

051099 Mr. & Mrs. Trucke now live there, unknown the name of previous renters/owners other than first name of Roy. They possibly moved to Minnesota and veh may be in garage or in MN. Rick Tisler II has more info from speaking with compl. who wants to remain anon. They were given inc number for reward purposes. as/926

45. IF COMPLAINANT DIFFERENT THEN CALLER, ENTER NAME, ADDRESS, D.O.B., TELEPHONE.

46. IF CODE O (OTHER) IS USED IN FIELD #39, EXPLAIN.

INCIDENT REPORT: NOTE: IF SECTION 22 ABOVE HAS NUMBER 4 CHECKED, DO NOT GO BEYOND THIS LINE WITHOUT RECORDS SECTION BEING ADVISED, OR NO RECORD ENTRIES WILL BE MADE BELOW THIS LINE.

PROPERTY VALUE	26. PROPERTY	A. CURRENCY	B. JEWELRY	C. FURS CLOTHING	D. VEHICLE (LOCAL)	E. OFFICE EQUIPMENT	F. RADIO, TV CAMERAS	G. FIREARMS	H. HOUSE-HOLD GOODS
	STOLEN	\$	\$	\$	\$	\$	\$	\$	\$
	RECOVERED	\$	\$	\$	\$	\$	\$	\$	\$
	26. PROPERTY	I. CONSUMABLES	J. LIVESTOCK	K. DRUGS	L. MARINE ITEMS	M. CONSTRUCTION ITEMS	N. LAWN AND GARDEN	O. SPORTING GOODS	P. MISC BICYCLE
	STOLEN	\$	\$	\$	\$	\$	\$	\$	\$
	RECOVERED	\$	\$	\$	\$	\$	\$	\$	\$

27. PROPERTY RECOVERED: LOCALLY _____ OTHER JURISDICTION _____ (INSERT O OR L)

PROPERTY ITEMIZATION	PROPERTY STOLEN/RECOVERED ITEMIZATION, USE THE FOLLOWING FORMAT				
	28. QUANTITY	29. ARTICLE NAME	30. BRAND NAME	31. SERIAL NUMBER	32. CODE
					S R <input type="checkbox"/> <input type="checkbox"/>
					S R <input type="checkbox"/> <input type="checkbox"/>
					S R <input type="checkbox"/> <input type="checkbox"/>
					S R <input type="checkbox"/> <input type="checkbox"/>

33. PROPERTY DAMAGE AMOUNT \$ _____

34. INSURANCE COMPANY _____

35. OFFICER ASSAULTED Y N

36. ARSON Y N

37. STRUCTURE CODE _____

38. DAMAGE \$ _____

47. CIB ENTERED CANCELLED
 NCIC
 OTHER BROADCAST

48. TOTAL AMOUNT PROPERTY STOLEN \$ _____

49. TOTAL AMOUNT PROPERTY RECOVERED \$ _____

50. IS REPORT CONTINUED? YES NO

51. CAUTION INDICATORS, ATLS ETC.

52. DATA PROCESS INFORMATION:
 COMPUTER ENTERED DATE 5/17/00
 MICROFILM INDEXED INITIAL KS
 IS CASE CLASSIFICATION CORRECT? Y N
 IF N HAS CORRECTION BEEN MADE? Y N

53. FILE APPROVAL
 BY [Signature] DATE 05/16/00

1. CASE # S99 No 03744
 2. CLASSIFICATION 6310.11
 3. CENSUS 70000

4. INCIDENT CS/899-60242
 5. INCIDENT LOCATION New Holstein
 6. NAME - LAST - FIRST - MI ANON.
 7. D.O.B.
 8. ADDRESS
 9. TX-HOME
 11. CITY STATE ZIP
 10. TX-BUSINESS

12. DETAILS
 Caller's wife saw a silver truck (blu stripe), # AK99885, approx. 1 week ago in New Holstein. Veh. had grill damage, & lot of rust.

05.13.99 1026

14. REC'D
 15. DISP
 16. 10-23
 17. 10-24
 13. DAY
 SUN 1 THU 5
 MON 2 FRI 6
 TUE 3 SAT 7
 WED 4

MANITOWOC COUNTY SHERIFF
 INCIDENT CARD

18. ASSIGNED MISO 929

19. REC. BY 920
 20. DIS. BY

22. TYPE OF REPORT
 1. INCIDENT
 2. ACCIDENT
 3. CITATION
 4. NONE

21. HOW REC'D.
 1. 911
 2. POLICE RADIO
 3. PHONE
 4. TTY
 5. IN PERSON
 6. ON VIEW
 7. OFF. OFF DUTY
 8. C.B. RADIO
 9. OTHER
 21A. M.O.

23. STATUS
 1. UNFOUNDED
 2. PNL
 3. OTHER
 4. CLEARED
 5. EXCEPT CLEARED

24. DATE CLEARED 06/01/99

25. OFFENSE TYPE
 1. ADULT
 2. JUVENILE
 3. UNKNOWN
 NA

39. (CODE S-SUSPECT W-WITNESS V-VICTIM O-OTHER)						
CODE	40. NAME-LAST	FIRST	MI	41. D.O.B.	42. ADDRESS	43. TELEPHONE
O	Mueller David R. Jr.				█ E. Main Apt 1 Chilton	

05/13/99 0005hrs Arrangements made to have a Chilton Police Officer accompany me to the above address. The parking lot was checked and the vehicle not there. Mueller was recently married and moved somewhere else in Chilton. The officer was familiar with the vehicle and described it exactly like the information above only adding "This would be the smaller Chev S-10 truck not a full size." Mueller works for Breiss Industries at 0630hrs. The officer will double check the registration to match the complaint. If there would be any difference he will call or leave message definitely 05/14/99.
 05/14/99 No message, Close out Complaint. M.J. Bushman

S99 No 03744

45. IF COMPLAINANT DIFFERENT THEN CALLER, ENTER NAME, ADDRESS, D.O.B., TELEPHONE.

46. IF CODE O (OTHER) IS USED IN FIELD #39, EXPLAIN.

INCIDENT REPORT: NOTE: IF SECTION 22 ABOVE HAS NUMBER 4 CHECKED, DO NOT GO BEYOND THIS LINE WITHOUT RECORDS SECTION BEING ADVISED, OR NO RECORD ENTRIES WILL BE MADE BELOW THIS LINE.

PROPERTY VALUE	26. PROPERTY	A. CURRENCY	B. JEWELRY	C. FURS CLOTHING	D. VEHICLE (LOCAL)	E. OFFICE EQUIPMENT	F. RADIO, TV CAMERAS	G. FIREARMS	H. HOUSE-HOLD GOODS
	STOLEN	\$	\$	\$	\$	\$	\$	\$	\$
	RECOVERED	\$	\$	\$	\$	\$	\$	\$	\$
	26. PROPERTY	I. CONSUMABLES	J. LIVESTOCK	K. DRUGS	L. MARINE ITEMS	M. CONSTRUCTION ITEMS	N. LAWN AND GARDEN	O. SPORTING GOODS	P. MISC BICYCLE
	STOLEN	\$	\$	\$	\$	\$	\$	\$	\$
	RECOVERED	\$	\$	\$	\$	\$	\$	\$	\$

27. PROPERTY RECOVERED: LOCALLY ____ OTHER JURISDICTION ____ (INSERT O OR L)

PROPERTY ITEMIZATION	PROPERTY STOLEN/RECOVERED ITEMIZATION, USE THE FOLLOWING FORMAT				
	28. QUANTITY	29. ARTICLE NAME	30. BRAND NAME	31. SERIAL NUMBER	32. CODE
					S R <input type="checkbox"/> <input type="checkbox"/>
					S R <input type="checkbox"/> <input type="checkbox"/>
					S R <input type="checkbox"/> <input type="checkbox"/>
					S R <input type="checkbox"/> <input type="checkbox"/>
					S R <input type="checkbox"/> <input type="checkbox"/>

33. PROPERTY DAMAGE AMOUNT \$ _____

34. INSURANCE COMPANY _____

35. OFFICER ASSAULTED Y N 36. ARSON Y N 37. STRUCTURE CODE _____ 38. DAMAGE \$ _____

47. CIB ENTERED CANCELLED
 NCIC
 OTHER BROADCAST

48. TOTAL AMOUNT PROPERTY STOLEN \$ _____

49. TOTAL AMOUNT PROPERTY RECOVERED \$ _____

50. IS REPORT CONTINUED? YES NO

51. CAUTION INDICATORS, ATLS ETC.

52. DATA PROCESS INFORMATION:

COMPUTER ENTERED DATE 10/29/99
 MICROFILM INDEXED INITIAL AS

53. FILE APPROVAL

IS CASE CLASSIFICATION CORRECT? Y N
 IF N HAS CORRECTION BEEN MADE? Y N

BY JK DATE 10/29/99

1. CASE # 599 N ^o 03752	2. CLASSIFICATION 631011	3. CENSUS 1,410,12
4. INCIDENT 05/599-00242		
5. INCIDENT LOCATION CR		
6. NAME - LAST - FIRST - MI ANONYMOUS (2)	7. D.O.B.	
8. ADDRESS	9. TX - HOME	
11. CITY STATE ZIP	10. TX - BUSINESS	
12. DETAILS Reports Red Cab of Pick up Truck in field N of County Line - can be seen on East side of I-43 mm 136		

1445
1503
05-13-99
14
15
16
17
13. DAY
SUN 1 THU 5
MON 2 FRI 6
TUE 3 SAT 7
WED 4

MANITOWOC COUNTY SHERIFF INCIDENT CARD		
18. ASSIGNED Ledvina 4147		
19. REC. BY 939	20. DIS. BY 939	22. TYPE OF REPORT 1. INCIDENT 2. ACCIDENT 3. CITATION 4. NONE
21. HOW REC'D. 1. 911 2. POLICE RADIO 3. PHONE 4. TTY 5. IN PERSON 6. ON VIEW 7. OFF. OFF DUTY 8. C.B. RADIO 9. OTHER		23. STATUS 1. UNFOUNDED 2. PNL 3. OTHER 4. CLEARED 5. EXCEPT CLEARED
21A. M.O.		24. DATE CLEARED 05/17/99
		25. OFFENSE TYPE 1. ADULT <input type="checkbox"/> NA <input type="checkbox"/> 2. JUVENILE <input type="checkbox"/> 3. UNKNOWN <input type="checkbox"/>

39. (CODE S-SUSPECT W-WITNESS V-VICTIM O-OTHER)	40. NAME - LAST	FIRST	MI	41. D.O.B.	42. ADDRESS	43. TELEPHONE
0	KLINZING	DAVID	A		DAIRYLAND DR. CLEVELAND	

05/13/99 Crimestopper tip received regarding the cab of a red pick up truck recently placed in a field east of I43 and north of Countyline Rd.

Deputy Ledvina responded to the area and did find the cab of a red pick up truck (without the frame of the vehicle.) The location was in a fenced in area adjacent to a cow pasture east of the Interstate. Deputy Ledvina was unable to assure the make or year of the vehicle.

Deputy Ledvina attempted contact at the residence for further follow up but was unable to make contact with anyone. Information was passed on to Sgt. Hermann.

It should be noted that one of our dispatchers is familiar with the residents from incidents occurring in the Sheboygan Co. Dispatch has advised that officers should not attempt contact at the residence without back up. CLedvina/CLedvina

05/14/99 @ 2315 Hrs.: I, Sgt. Hermann, did inspect the truck cab which was in the field north of County Line Rd., east of I-43. In checking the cab it appeared to be a 1980's model Chevy, red in color. There was no frame under this vehicle and the front end was dismantled from the cab. The VIN [redacted] came back as no record on file.

It did appear that this cab, red in color, had been sitting in the field for an extended period of time as there were weeds around it, but no vegetation underneath. The fenders from the vehicle were black in color inside the cab and it did not appear that there was any damage to them. In checking the vehicle it appears this vehicle had been dismantled for quite some time and I did not observe any areas which would have been dismantled or worked on recently.

This incident can be closed out. THerman /paf



599 N^o 03752

45. IF COMPLAINANT DIFFERENT THEN CALLER, ENTER NAME, ADDRESS, D.O.B., TELEPHONE.

46. IF CODE O (OTHER) IS USED IN FIELD #39, EXPLAIN.

INCIDENT REPORT: NOTE: IF SECTION 22 ABOVE HAS NUMBER 4 CHECKED, DO NOT GO BEYOND THIS LINE WITHOUT RECORDS SECTION BEING ADVISED, OR NO RECORD ENTRIES WILL BE MADE BELOW THIS LINE.

PROPERTY VALUE	26. PROPERTY	A. CURRENCY	B. JEWELRY	C. FURS CLOTHING	D. VEHICLE (LOCAL)	E. OFFICE EQUIPMENT	F. RADIO, TV CAMERAS	G. FIREARMS	H. HOUSE-HOLD GOODS
	STOLEN	\$	\$	\$	\$	\$	\$	\$	\$
	RECOVERED	\$	\$	\$	\$	\$	\$	\$	\$
	26. PROPERTY	I. CONSUMABLES	J. LIVESTOCK	K. DRUGS	L. MARINE ITEMS	M. CONSTRUCTION ITEMS	N. LAWN AND GARDEN	O. SPORTING GOODS	P. MISC BICYCLE
	STOLEN	\$	\$	\$	\$	\$	\$	\$	\$
	RECOVERED	\$	\$	\$	\$	\$	\$	\$	\$

27. PROPERTY RECOVERED: LOCALLY _____ OTHER JURISDICTION _____ (INSERT O OR L)

PROPERTY ITEMIZATION	PROPERTY STOLEN/RECOVERED ITEMIZATION, USE THE FOLLOWING FORMAT				
	28. QUANTITY	29. ARTICLE NAME	30. BRAND NAME	31. SERIAL NUMBER	32. CODE
					S R <input type="checkbox"/> <input type="checkbox"/>
					S R <input type="checkbox"/> <input type="checkbox"/>
					S R <input type="checkbox"/> <input type="checkbox"/>
					S R <input type="checkbox"/> <input type="checkbox"/>

33. PROPERTY DAMAGE AMOUNT \$ _____

34. INSURANCE COMPANY _____

35. OFFICER ASSAULTED Y N

36. ARSON Y N

37. STRUCTURE CODE _____

38. DAMAGE \$ _____

47. CIB ENTERED CANCELLED
 NCIC
 OTHER BROADCAST

48. TOTAL AMOUNT PROPERTY STOLEN \$ _____

49. TOTAL AMOUNT PROPERTY RECOVERED \$ _____

50. IS REPORT CONTINUED? YES NO

51. CAUTION INDICATORS, ATLS ETC.

52. DATA PROCESS INFORMATION:

COMPUTER ENTERED DATE 5/20/99

MICROFILM INDEXED INITIAL KS

IS CASE CLASSIFICATION CORRECT? N
 IF N HAS CORRECTION BEEN MADE? N

53. FILE APPROVAL

BY QR

DATE 05/17/99

1. CASE # S99 No 03771 2. CLASSIFICATION 630.11 3. CENSUS 17,0000

4. INCIDENT CS S99-00242

5. INCIDENT LOCATION

6. NAME - LAST - FIRST - MI Fond Du Lac Co Sheriff 7. D.O.B.

8. ADDRESS 4049 9. TX-HOME

11. CITY STATE ZIP 10. TX-BUSINESS

12. DETAILS reg. to start inc. re; crime stopper info

5/14/99 1021

MANITOWOC COUNTY SHERIFF INCIDENT CARD

18. ASSIGNED Colborn 432

19. REC. BY 921 20. DIS. BY

22. TYPE OF REPORT
 1. INCIDENT
 2. ACCIDENT
 3. CITATION
 4. NONE

21. HOW REC'D.
 1. 911
 2. POLICE RADIO
 3. PHONE
 4. TTY
 5. IN PERSON
 6. ON VIEW
 7. OFF. OFF DUTY
 8. C.B. RADIO
 9. OTHER

23. STATUS
 1. UNFOUNDED
 2. PNL
 3. OTHER
 4. CLEARED
 5. EXCEPT CLEARED

24. DATE CLEARED 05/18/99

25. OFFENSE TYPE
 1. ADULT NA
 2. JUVENILE
 3. UNKNOWN

14. REC'D
 15. DISP
 16. 10-23
 17. 10-24

13. DAY
 SUN 1 THU 5
 MON 2 FRI 6
 TUE 3 SAT 7
 WED 4

39. (CODE S-SUSPECT W-WITNESS V-VICTIM O-OTHER)							
CODE	40. NAME-LAST	FIRST	MI	41. D.O.B.	42. ADDRESS	43. TELEPHONE	
0	BALTHAZOR	BRUCE	E		Wisconsin Ave, Fond du Lac		

05/13/99: I, Deputy A. Colborn, was assigned this incident by DI Tisler. DI Tisler informed me that Mike Hardgrove from FDSO had called and stated that a brown Chevy van had been involved in a 10-50 in their county. Officer Hardgrove informed DI Tisler that the van had been missing its grill prior to its involvement in the 10-50. Officer Hardgrove provided a copy of the accident report in which the brown van was involved as well as a copy of the FDSO incident report that was generated for this incident. (See attached copy of Document # [redacted] and FDSO Incident Report #99-016560-I.)

I was instructed by 1200-2000 hour Shift Commander Sgt. Schetter to respond to the City of Fond du Lac on 05/14/99 due to manpower shortages on 05/13/99.

05/14/99 @ 1000 Hrs.: I, Deputy A. Colborn, responded to Lyle's Towing and Body Shop, located at [redacted] Van Dyne Rd, Fond du Lac. Upon arrival I made contact with BRUCE BALTHAZOR who informed me that he was the individual who had originally contacted FDSO reference this incident.

BALTHAZOR then directed my attention to a brown 2-tone Chevy full size van bearing VIN # [redacted]. I did observe that BALTHAZOR had the title for the vehicle and did observe that the VIN on the vehicle matched the VIN on the WI Certificate of Title. I further noted the van to be last owned by WILLIAM J. FARROW, with an address of [redacted] Riverside Dr, Kaukauna. BALTHAZOR stated that WILLIAM'S son, BENJAMIN, had been operating the vehicle on 02/12/99 when it became involved in a traffic crash in Fond du Lac county.

I did observe the front of the van to be damaged. However, the majority of the damage was on the driver's side of the vehicle. BALTHAZOR informed me that the vehicle had sustained this damage on 02/12/99 when the vehicle had struck a bridge abutment.

Upon examination of the front passenger's side of the vehicle I did observe a large dent in the bumper area. However, I did observe the headlight bezel around the 2 head lamps to be relatively intact. I further observed the hood and passenger side front fender to be free of any damage.

S99 No 03771

45. IF COMPLAINANT DIFFERENT THEN CALLER, ENTER NAME, ADDRESS, D.O.B., TELEPHONE.

46. IF CODE O (OTHER) IS USED IN FIELD #39, EXPLAIN.

INCIDENT REPORT: NOTE: IF SECTION 22 ABOVE HAS NUMBER 4 CHECKED, DO NOT GO BEYOND THIS LINE WITHOUT RECORDS SECTION BEING ADVISED, OR NO RECORD ENTRIES WILL BE MADE BELOW THIS LINE.

PROPERTY VALUE	26. PROPERTY	A. CURRENCY	B. JEWELRY	C. FURS CLOTHING	D. VEHICLE (LOCAL)	E. OFFICE EQUIPMENT	F. RADIO, TV CAMERAS	G. FIREARMS	H. HOUSE-HOLD GOODS
	STOLEN	\$	\$	\$	\$	\$	\$	\$	\$
	RECOVERED	\$	\$	\$	\$	\$	\$	\$	\$
	26. PROPERTY	I. CONSUM-ABLES	J. LIVESTOCK	K. DRUGS	L. MARINE ITEMS	M. CONSTRUCTION ITEMS	N. LAWN AND GARDEN	O. SPORTING GOODS	P. MISC BICYCLE
	STOLEN	\$	\$	\$	\$	\$	\$	\$	\$
	RECOVERED	\$	\$	\$	\$	\$	\$	\$	\$

27. PROPERTY RECOVERED: LOCALLY _____ OTHER JURISDICTION _____ (INSERT O OR L)

PROPERTY ITEMIZATION	PROPERTY STOLEN/RECOVERED ITEMIZATION, USE THE FOLLOWING FORMAT				
	28. QUANTITY	29. ARTICLE NAME	30. BRAND NAME	31. SERIAL NUMBER	32. CODE
					S <input type="checkbox"/> R <input type="checkbox"/>
					S <input type="checkbox"/> R <input type="checkbox"/>
					S <input type="checkbox"/> R <input type="checkbox"/>
					S <input type="checkbox"/> R <input type="checkbox"/>

33. PROPERTY DAMAGE AMOUNT \$ _____

34. INSURANCE COMPANY _____

35. OFFICER ASSAULTED Y N 36. ARSON Y N 37. STRUCTURE CODE _____ 38. DAMAGE \$ _____

47. CIB ENTERED CANCELLED
 NCIC
 OTHER BROADCAST

48. TOTAL AMOUNT PROPERTY STOLEN \$ _____

49. TOTAL AMOUNT PROPERTY RECOVERED \$ _____

50. IS REPORT CONTINUED? YES NO

51. CAUTION INDICATORS, ATLS ETC.

52. DATA PROCESS INFORMATION:

COMPUTER ENTERED DATE 16/1/99
 MICROFILM INDEXED INITIAL AS

53. FILE APPROVAL

IS CASE CLASSIFICATION CORRECT? Y N
 IF N HAS CORRECTION BEEN MADE? Y N

BY [Signature] DATE 10/5/18/99

MANITOWOC COUNTY SHERIFF'S DEPARTMENT
FOLLOW-UP REPORT

Page: 2

CASE NUMBER: S99-03771 CLASSIFICATION: _____

INCIDENT: _____

DATE AND TIME: _____

REPORT CONTINUED:

Upon raising the hood I, Deputy Colborn, noted the upper radiator support and the fan trowel to be intact and undamaged. This would not be consistent with the damage probably sustained by the suspect vehicle in incident #S99-00242.

I further noted that the tire tread design was not consistent with the tires utilized by the suspect vehicle in incident #S99-00242. I did note on the BALTHAZOR van all 4 tires to be made by the same manufacturer, Cooper, and all 4 tires to be radial GTs.

At this time I informed BALTHAZOR that I did not believe this vehicle was the suspect vehicle in the fatal Hit and Run which had occurred in Manitowoc County. However, I did take 9 Polaroid photographs of the BALTHAZOR van which BALTHAZOR told me he had assumed ownership of after towing the van from the scene of the traffic crash in Fond du Lac County. BALTHAZOR stated the van has been in his possession since 02/12/99 and has not been driven.

05/14/99 @ 2000 Hrs.: I, Deputy A. Colborn, showed the 9 photographs of the BALTHAZOR van to Incident Commander Lt. Bushman. At this time Lt. Bushman is in concurrence that this van in all likelihood is not the suspect vehicle for incident #S99-00242.

No further action taken at this time. This incident with attached FDSO report and the 9 Polaroid photographs is to be forwarded to Lt. Bushman for his review upon completion of typing. AColborn *a&c/eco*

Manitowoc County Sheriff's Department

Thomas H. Kocourek
SHERIFF

Kenneth J. Petersen
INSPECTOR

Fond du Lac Co



Mike Hargrove [REDACTED] [REDACTED] [REDACTED]

On 2/12/99 Fond du Lac Co handled a 10-50 with a brown 1983 Chev Van. The grill was missing but no parts were left at the scene (owner Bruce Beltazor)

Lyles Towing [REDACTED] Hwy 175 (also Van Dynerd) has the vehicle which was turned over for the tow fee.

Vehicle was owned by Wm Farrow and driven by his son Benjamin 5/10/78 who is a student at an ILL school

Case # for Fond du Lac is 99-5154
If using 151 take Scott St to the west to I believe 175 approx 2 miles outside North Fondy. Should be sign out front.

FOND DU LAC COUNTY SHERIFF'S DEPARTMENT

Gary M. Pucker
Sheriff

Mylan C. Fink, Jr.
Chief Deputy

S Macy Street
P.O. Box
Fond du Lac
Wisconsin 54936-1273
Fax

FAX COVER SHEET

DATE: 05/13/99 1:42 AM (PM)
TO: Deputy Coeborn
DEPARTMENT: Manitowoc County Sheriff's Office
FAX PHONE:

TOTAL NUMBER OF PAGES INCLUDING THIS COVER SHEET: 6

THIS TRANSMISSION SENT BY: Marge Hornes

IF YOU DID NOT RECEIVE ALL OF THE PAGES OR FIND THEY ARE
ILLEGIBLE, PLEASE CALL AS SOON AS POSSIBLE
THANK YOU.

6723812

Amended Document On Emergency

DEPARTMENT

Document Number Override

Wisconsin Motor Vehicle Accident Report

Police No. 99-2154

INSTRUCTIONS

Place the Mark in box or #1 Panel

Mark Areas as shown:

Control Mark

Insured Mark

Reportable Accident

County: **20**

MUN/TWP: **09**

Accident Date

MONTH	DAY	YEAR
Jan	1	99
Feb	2	99
Mar	3	99
Apr	4	99
May	5	99
June	6	99
July	7	99
Aug	8	99
Sept	9	99
Oct	10	99
Nov	11	99
Dec	12	99

Time of Accident (Military Time)

HOUR: **21** MIN: **41**

Total Number

UNITS INJURED	KILLED
0	2
0	0
0	0
0	0
0	0
0	0
0	0
0	0
0	0
0	0
0	0
0	0
0	0
0	0
0	0
0	0
0	0
0	0
0	0
0	0
0	0
0	0

Hit & Run

Government Property

Fire (Narrative)

Photos Taken (Narrative)

Trailer or Towed (Narrative)

Truck or Bus (Last Page)

Load Spillage

Construction Zone

Names Exchanged

Unit #

Sheet No. **12**

ACCIDENT LOCATION

Public Highway, Intersection/Related

Public Highway, Non-Intersection

Parking Lot

Private Property or Road

LATITUDE (GPS) Degrees: Minutes: Seconds: LONGITUDE (GPS) Degrees: Minutes: Seconds:

ON Hwy No. and / Street Name: **USH 41 NB** Estimated: **0.20** FROM/AT Hwy No. and / Street Name: **Sth 175**

House # Utility # Fire # Railroad # Other: Agency Space: Special Study:

Unit Number	Unit Type	Total Number of Occupants	Direction of Travel (Before the Accident)	Unit Number	Unit Type	Total Number of Occupants	Direction of Travel (Before the Accident)
1	2	3	4	1	2	3	4
5	6	7	8	5	6	7	8
9	10	11	12	9	10	11	12

Speed Limit: OPERATOR Last Name: **Farrow Benjamin J** MI: First Name: **Anderson Leah R** MI: First Name:

ADDRESS Street & Number: **Riverside Dr** ADDRESS Street & Number: **E. John St**

City & State: **Kaukaun WI 54130** City & State: **Appleton WI 54911**

Driver's License Number: **WI 01** Driver's License Number: **WI 01**

Date of Birth: Sex: Operating (Mark Only One) F M Other: On Duty Accident: Police EMT/First Responder Fire Fighter Winter Hwy Maintenance CMV Classified:

Severity: SEAT SAFETY AIRBAG EJECTED: SEAT SAFETY AIRBAG EJECTED: SEAT SAFETY AIRBAG EJECTED:

TRAPPED/EXTORTIONATED: TRAPPED/EXTORTIONATED: TRAPPED/EXTORTIONATED:

Vehicle Owner Last Name: **Farrow Benjamin J** Vehicle Owner Last Name: **Lawrence University**

Street Address: **Riverside Dr** Street Address: **Box**

City & State: **Kaukaun WI 54130** City & State: **Appleton WI 54912**

Year of Vehicle: **1993** Year of Vehicle: **1993**

Vehicle ID Number: **Chev C-10 Van Bro** Vehicle ID Number: **Ford Econo Van Blu**

License Plate Number: **SFE-985** License Plate Number: **LGI-384**

Policy Holder's Name: **Heritage** Policy Holder's Name: **GENA**

Occupant Unit Number: **Sandra Jason P** Date of Birth: Sex: Severity: SEAT SAFETY AIRBAG EJECTED:

ADDRESS Street & Number: **E College Ave Appleton WI 54911** ADDRESS Street & Number: **E College Ave Appleton WI 54911**

as Operator: Yes No Not Ejected Not Applicable Partially Ejected Unknown

Agency Space: **NOT** EMS Number:

Location: **MV4000 1296**

Wisconsin Motor Vehicle Accident Report Supplement

Document Number Override	
5725810	
Sheet No.	OF
22	

Occupant and Fixed Object Struck Supplement

INSTRUCTIONS: This supplement may be used to list additional occupant and fixed object struck information associated with an accident. Enter the original accident report document number in the "Document Number Override" box, enter the correct page number in the "Sheet No. Of" box. Then, follow the instructions for fields 65-78 (occupants) and/or fields 82-87 (fixed objects struck), as appropriate, in the Law Enforcement Officer's Instruction Manual.

Occupant Unit Number 65	NAME Last First Golbert Kolin J	M.I.	Date of Birth	Sex F	Severity K A B C	SEAT Position 7	SAFETY Equipment 1	AIRBAG 1 Deployed 2 Non Deployed 3 Not Applicable 4 Unknown
	ADDRESS Street & Number E JOHN ST Appleton WI 54911		City & State	ZIP				
Address Same as Operator Yes No	EJECTED 1 Not Applicable 2 Not Ejected 3 Totally Ejected 4 Partially Ejected 5 Unknown	TRAPPED/EXTRICATED 1 Not Applicable 2 Not Trapped	3 Trapped/Extricated 4 Trapped/Not Extricated 5 Unknown	Medical Transport	Agency Space			
Occupant Unit Number 66	NAME Last First Brunswick Jason S	M.I.	Date of Birth	Sex E	Severity K A B C	SEAT Position 9	SAFETY Equipment 1	AIRBAG 1 Deployed 2 Non Deployed 3 Not Applicable 4 Unknown
	ADDRESS Street & Number E JOHN ST Appleton WI 54911		City & State	ZIP				
Address Same as Operator Yes No	EJECTED 1 Not Applicable 2 Not Ejected 3 Totally Ejected 4 Partially Ejected 5 Unknown	TRAPPED/EXTRICATED 1 Not Applicable 2 Not Trapped	3 Trapped/Extricated 4 Trapped/Not Extricated 5 Unknown	Medical Transport	Agency Space			
Occupant Unit Number 66	NAME Last First	M.I.	Date of Birth	Sex M F	Severity K A B C	SEAT Position	SAFETY Equipment	AIRBAG 1 Deployed 2 Non Deployed 3 Not Applicable 4 Unknown
	ADDRESS Street & Number		City & State	ZIP				
Address Same as Operator Yes No	EJECTED 1 Not Applicable 2 Not Ejected 3 Totally Ejected 4 Partially Ejected 5 Unknown	TRAPPED/EXTRICATED 1 Not Applicable 2 Not Trapped	3 Trapped/Extricated 4 Trapped/Not Extricated 5 Unknown	Medical Transport	Agency Space			
Occupant Unit Number 66	NAME Last First	M.I.	Date of Birth	Sex M F	Severity K A B C	SEAT Position	SAFETY Equipment	AIRBAG 1 Deployed 2 Non Deployed 3 Not Applicable 4 Unknown
	ADDRESS Street & Number		City & State	ZIP				
Address Same as Operator Yes No	EJECTED 1 Not Applicable 2 Not Ejected 3 Totally Ejected 4 Partially Ejected 5 Unknown	TRAPPED/EXTRICATED 1 Not Applicable 2 Not Trapped	3 Trapped/Extricated 4 Trapped/Not Extricated 5 Unknown	Medical Transport	Agency Space			
Occupant Unit Number 66	NAME Last First	M.I.	Date of Birth	Sex M F	Severity K A B C	SEAT Position	SAFETY Equipment	AIRBAG 1 Deployed 2 Non Deployed 3 Not Applicable 4 Unknown
	ADDRESS Street & Number		City & State	ZIP				
Address Same as Operator Yes No	EJECTED 1 Not Applicable 2 Not Ejected 3 Totally Ejected 4 Partially Ejected 5 Unknown	TRAPPED/EXTRICATED 1 Not Applicable 2 Not Trapped	3 Trapped/Extricated 4 Trapped/Not Extricated 5 Unknown	Medical Transport	Agency Space			
Occupant Unit Number 66	NAME Last First	M.I.	Date of Birth	Sex M F	Severity K A B C	SEAT Position	SAFETY Equipment	AIRBAG 1 Deployed 2 Non Deployed 3 Not Applicable 4 Unknown
	ADDRESS Street & Number		City & State	ZIP				
Address Same as Operator Yes No	EJECTED 1 Not Applicable 2 Not Ejected 3 Totally Ejected 4 Partially Ejected 5 Unknown	TRAPPED/EXTRICATED 1 Not Applicable 2 Not Trapped	3 Trapped/Extricated 4 Trapped/Not Extricated 5 Unknown	Medical Transport	Agency Space			
Occupant Unit Number 66	NAME Last First	M.I.	Date of Birth	Sex M F	Severity K A B C	SEAT Position	SAFETY Equipment	AIRBAG 1 Deployed 2 Non Deployed 3 Not Applicable 4 Unknown
	ADDRESS Street & Number		City & State	ZIP				
Address Same as Operator Yes No	EJECTED 1 Not Applicable 2 Not Ejected 3 Totally Ejected 4 Partially Ejected 5 Unknown	TRAPPED/EXTRICATED 1 Not Applicable 2 Not Trapped	3 Trapped/Extricated 4 Trapped/Not Extricated 5 Unknown	Medical Transport	Agency Space			
Occupant Unit Number 66	NAME Last First	M.I.	Date of Birth	Sex M F	Severity K A B C	SEAT Position	SAFETY Equipment	AIRBAG 1 Deployed 2 Non Deployed 3 Not Applicable 4 Unknown
	ADDRESS Street & Number		City & State	ZIP				
Address Same as Operator Yes No	EJECTED 1 Not Applicable 2 Not Ejected 3 Totally Ejected 4 Partially Ejected 5 Unknown	TRAPPED/EXTRICATED 1 Not Applicable 2 Not Trapped	3 Trapped/Extricated 4 Trapped/Not Extricated 5 Unknown	Medical Transport	Agency Space			
Occupant Unit Number 66	NAME Last First	M.I.	Date of Birth	Sex M F	Severity K A B C	SEAT Position	SAFETY Equipment	AIRBAG 1 Deployed 2 Non Deployed 3 Not Applicable 4 Unknown
	ADDRESS Street & Number		City & State	ZIP				
Address Same as Operator Yes No	EJECTED 1 Not Applicable 2 Not Ejected 3 Totally Ejected 4 Partially Ejected 5 Unknown	TRAPPED/EXTRICATED 1 Not Applicable 2 Not Trapped	3 Trapped/Extricated 4 Trapped/Not Extricated 5 Unknown	Medical Transport	Agency Space			

Occupant Unit Number: **19**

NAME: Last **Warrick**, First **Jay**, M.I. **W**, Date of Birth **[REDACTED]**, Sex **F**, Severity **A**

ADDRESS: Street & Number **[REDACTED] South St**, City & State **Appleton WI**, ZIP **54911**

Address Same as Operator: Yes, No

EJECTED: Not Ejected, Partially Ejected, Unknown

TRAPPED/EXTRICATED: Not Trapped, Unknown

SEAT Position: **4**

SAFETY Equipment: Yes, No

AIRBAG: Deployed, Non Deployed, Not Applicable, Unknown

Occupant Unit Number: **19**

NAME: Last **Johnson**, First **Loren**, M.I. **L**, Date of Birth **[REDACTED]**, Sex **F**, Severity **K**

ADDRESS: Street & Number **[REDACTED] South St**, City & State **Appleton WI**, ZIP **54911**

Address Same as Operator: Yes, No

EJECTED: Not Ejected, Partially Ejected, Unknown

TRAPPED/EXTRICATED: Not Trapped, Unknown

SEAT Position: **4**

SAFETY Equipment: Yes, No

AIRBAG: Deployed, Non Deployed, Not Applicable, Unknown

Type of Accident

01 First Harmful Event

Most Harmful Event

Unit Number	Unit Number
<input type="checkbox"/> 2 <input type="checkbox"/> 3 <input type="checkbox"/> 4 <input type="checkbox"/> 5	<input type="checkbox"/> 1 <input type="checkbox"/> 3 <input type="checkbox"/> 5
<input type="checkbox"/> 6 <input type="checkbox"/> 7 <input type="checkbox"/> 8 <input type="checkbox"/> 9 <input type="checkbox"/> 10	<input type="checkbox"/> 5 <input type="checkbox"/> 7 <input type="checkbox"/> 8 <input type="checkbox"/> 9 <input type="checkbox"/> 10

(select one per vehicle)

Collision With Object Not Fixed

1 Motor Vehicle in Transport	<input checked="" type="checkbox"/>
2 Parked Motor Vehicle	<input type="checkbox"/>
3 Deer	<input type="checkbox"/>
4 Pedalcycle	<input type="checkbox"/>
5 Pedestrian	<input type="checkbox"/>
6 Railway Train	<input type="checkbox"/>
7 Other Animal	<input type="checkbox"/>
8 Motor Vehicle in Transport In Other Roadway	<input type="checkbox"/>
9 Other Object (Not Fixed)	<input type="checkbox"/>

Collision With Fixed Object

1 Traffic Sign Post	<input type="checkbox"/>
2 Traffic Signal	<input type="checkbox"/>
3 Utility Pole	<input type="checkbox"/>
4 Lum. Light Support	<input type="checkbox"/>
5 Other Post	<input type="checkbox"/>
6 Tree	<input type="checkbox"/>
7 Mailbox	<input type="checkbox"/>
8 Guardrail Face	<input type="checkbox"/>
9 Guardrail End	<input type="checkbox"/>
10 Median Barrier	<input type="checkbox"/>
11 Bridge Parapet End	<input type="checkbox"/>
12 Bridge/Pier/Abut.	<input type="checkbox"/>
13 Impact Attenuator	<input type="checkbox"/>
14 Overhead Sign Post	<input type="checkbox"/>
15 Bridge Rail	<input type="checkbox"/>
16 Culvert	<input type="checkbox"/>
17 Ditch	<input type="checkbox"/>
18 Curb	<input type="checkbox"/>
19 Embankment	<input type="checkbox"/>
20 Fence	<input type="checkbox"/>
21 Other Fixed Object	<input type="checkbox"/>
22 Unknown	<input type="checkbox"/>

Non-Collision

23 Overturn	<input type="checkbox"/>
24 Fire/Explosion	<input type="checkbox"/>
25 Immersion	<input type="checkbox"/>
26 Jackknife	<input type="checkbox"/>
27 Other Non-Collision	<input type="checkbox"/>

Driver Condition

Unit Number	Unit Number
<input type="checkbox"/> 2 <input type="checkbox"/> 3 <input type="checkbox"/> 4 <input type="checkbox"/> 5	<input type="checkbox"/> 1 <input type="checkbox"/> 3 <input type="checkbox"/> 5
<input type="checkbox"/> 6 <input type="checkbox"/> 7 <input type="checkbox"/> 8 <input type="checkbox"/> 9 <input type="checkbox"/> 10	<input type="checkbox"/> 5 <input type="checkbox"/> 7 <input type="checkbox"/> 8 <input type="checkbox"/> 9 <input type="checkbox"/> 10

Driver Factors (Or Pedestrians)

1 Appeared Normal	<input checked="" type="checkbox"/>
2 Reduced Alertness	<input type="checkbox"/>
3 Ability Impaired	<input type="checkbox"/>
4 Not Observed	<input type="checkbox"/>

Presence

Neither Alcohol nor Drugs Present

6 Yes—Alcohol Present	<input type="checkbox"/>
7 Yes—Drugs Present	<input type="checkbox"/>
8 Yes—Alcohol & Drugs Present	<input type="checkbox"/>
9 Unknown	<input type="checkbox"/>

Alcohol

AC Value	AC Value
<input type="text"/>	<input type="text"/>

Test Results

11 Test Not Given	<input type="checkbox"/>
12 Test Given, Alcohol Unknown	<input type="checkbox"/>
13 Test Given, No Alcohol Reported	<input type="checkbox"/>

Drugs

15 Test Not Given	<input type="checkbox"/>
16 Test Refused	<input type="checkbox"/>
17 Test Given, Drugs Unknown	<input type="checkbox"/>
18 Test Given, No Drugs Reported	<input type="checkbox"/>
19 Drugs Reported (Specify Below)	<input type="checkbox"/>

19 Marijuana	<input type="checkbox"/>
20 Cocaine	<input type="checkbox"/>
21 Opiates	<input type="checkbox"/>
22 Amphetamines	<input type="checkbox"/>
23 PCP	<input type="checkbox"/>
24 Other Drug Medication	<input type="checkbox"/>
25 Type Unknown	<input type="checkbox"/>

Unit # **19**

Pedestrian

Location	Action
1 In Crosswalk	<input type="checkbox"/> Walking not Facing Traffic
2 In Roadway	<input type="checkbox"/> Disregarded Signal
3 Not in Roadway	<input type="checkbox"/> Darting into Road
4 On Sidewalk	<input type="checkbox"/> Dark Clothing
	<input type="checkbox"/> Walking Facing Traffic

Manner of Collision

1 No Collision with Motor Vehicle in Transport	<input type="checkbox"/>
2 Rear-end	<input type="checkbox"/>
3 Head On	<input type="checkbox"/>
4 Rear to Rear	<input type="checkbox"/>
5 Angle	<input type="checkbox"/>
6 Sideswipe, Same Direction	<input type="checkbox"/>
7 Sideswipe, Opposite Direction	<input type="checkbox"/>
8 Unknown	<input type="checkbox"/>

Unit # **19**

Darken Numbered Area(s) of Vehicle Damage

9 None	<input type="checkbox"/>
10 Undercarriage	<input type="checkbox"/>
11 Total (Damage to all Areas)	<input type="checkbox"/>
12 Other	<input type="checkbox"/>
13 Unknown	<input type="checkbox"/>

Extent of Damage

1 None	<input type="checkbox"/>
2 Very Minor	<input type="checkbox"/>
3 Minor	<input type="checkbox"/>
4 Moderate	<input type="checkbox"/>
5 Severe	<input type="checkbox"/>
6 Very Severe	<input type="checkbox"/>
7 Unknown	<input type="checkbox"/>

Vehicle Towed Due to Damage:

Vehicle Removed By: **Officer**

By: **LES request**

Unit # **19**

Darken Numbered Area(s) of Vehicle Damage

9 None	<input type="checkbox"/>
10 Undercarriage	<input type="checkbox"/>
11 Total (Damage to all Areas)	<input type="checkbox"/>
12 Other	<input type="checkbox"/>
13 Unknown	<input type="checkbox"/>

Extent of Damage

1 None	<input type="checkbox"/>
2 Very Minor	<input type="checkbox"/>
3 Minor	<input type="checkbox"/>
4 Moderate	<input type="checkbox"/>
5 Severe	<input type="checkbox"/>
6 Very Severe	<input type="checkbox"/>
7 Unknown	<input type="checkbox"/>

Vehicle Towed Due to Damage:

Vehicle Removed By: **Operator**

Fixed Object Struck

Unit #	Unit #	Unit #	Unit #
19			

Govt. Damage Tag # **19**

PROPERTY TAG

OWNER: **Fond Du Lac Co Hwy Dept**

ADDRESS: Street & Number **Dixie St**

City & State **Fond Du Lac WI**, ZIP **54939**, Phone Number **(920)**

Draw Diagram of Accident & Indicate North with an arrow in the circle.



Pictorial Representation of Narrative

Supplemental Reports Witness Statements Measurements Taken

Skidmarks to Impact
Unit 1 109 Unit 2
FEET

Surface Type: Asphalt

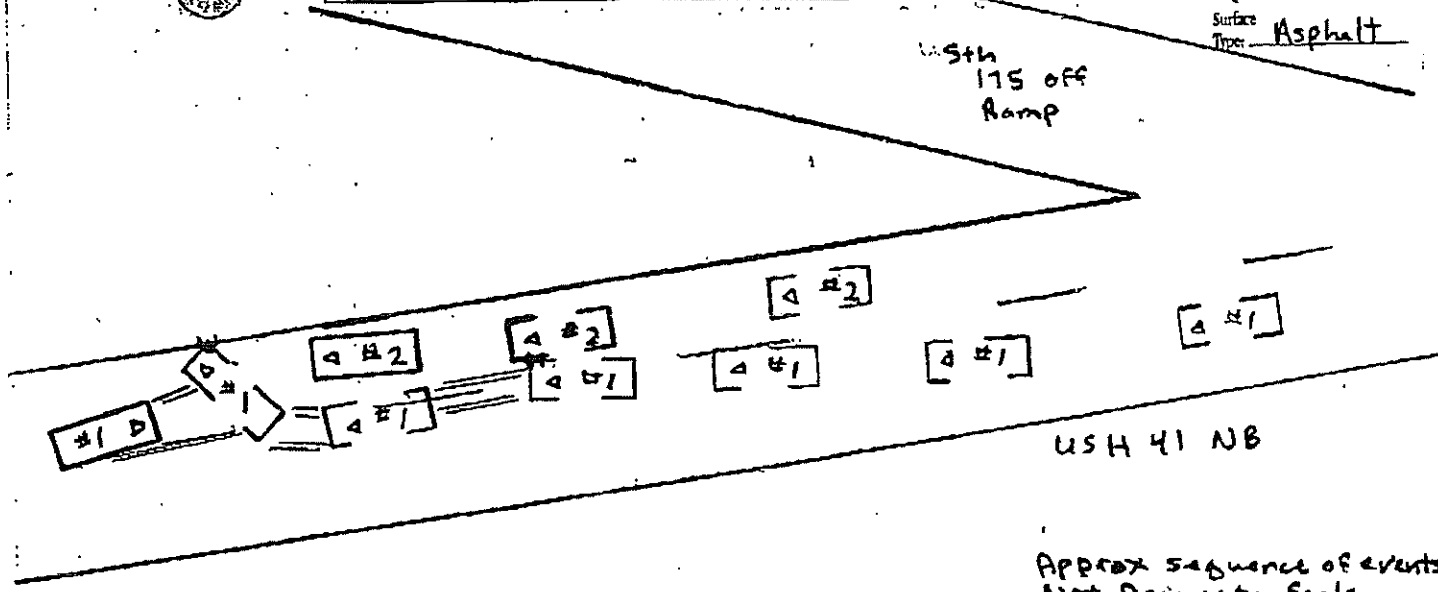

Approx sequence of events
Not drawn to scale

N Both units NB unit #1 in left lane,
A #2 in right lane, both negotiating
R the curve, unit #1 crossed dividing
R line sideswiping unit #2. #1 lost
A control struck cement median barrier
T and came to rest facing S&W NB
I lanes. Unit #2 moved prior to my
V arrival

Photos By: None

What Drivers Were Doing	
Unit Number	Unit Number
<input checked="" type="checkbox"/> 2	<input checked="" type="checkbox"/> 1
<input type="checkbox"/> 3	<input type="checkbox"/> 3
<input type="checkbox"/> 4	<input type="checkbox"/> 4
<input type="checkbox"/> 5	<input type="checkbox"/> 5
<input type="checkbox"/> 6	<input type="checkbox"/> 6
<input type="checkbox"/> 7	<input type="checkbox"/> 7
<input type="checkbox"/> 8	<input type="checkbox"/> 8
<input type="checkbox"/> 9	<input type="checkbox"/> 9
<input type="checkbox"/> 10	<input type="checkbox"/> 10
<input type="checkbox"/> 11	<input type="checkbox"/> 11
<input type="checkbox"/> 12	<input type="checkbox"/> 12
<input type="checkbox"/> 13	<input type="checkbox"/> 13
<input type="checkbox"/> 14	<input type="checkbox"/> 14
<input type="checkbox"/> 15	<input type="checkbox"/> 15
<input type="checkbox"/> 16	<input type="checkbox"/> 16
<input type="checkbox"/> 17	<input type="checkbox"/> 17
<input type="checkbox"/> 18	<input type="checkbox"/> 18
<input type="checkbox"/> 19	<input type="checkbox"/> 19
<input type="checkbox"/> 20	<input type="checkbox"/> 20

WITNESS NAME	Last	First	MI
ADDRESS	Street & Number		Date of Birth
City & State	ZIP	Phone Number	()

ACCESS CONTROL

No Control (Unlimited Access)

Full Control (Only Ramp Entry/Exit)

Partial Control

TRAFFIC WAY

Not Physically Divided (2-Way Traffic)

Divided Highway, Median Strip, without Traffic Barrier

Divided Highway, Median Strip, with Traffic Barrier

One-Way Traffic

Parking Lot or Private Property

ROAD TERRAIN

Part A

Straight

Curve

Part B

Level/Flat

Hill

ROAD SURFACE CONDITION

Dry

Wet

Snow/Slush

Ice

Sand, Mud, Dirt, Oil

Other

Unknown

LIGHT CONDITION

Daylight

Dark-Not Lighted

Dark-Lighted

Dawn

Dusk

Unknown

WEATHER

Clear

Cloudy

Rain

Snow

Fog, Smog, Smoke

Sleet, Hail (Freezing Rain or Drizzle)

Blowing Sand, Soil, Dirt, Snow

Severe Crosswinds

Other

Unknown

RELATION TO ROADWAY

On Roadway

Parking Lot or Private Property

Shoulder (Other than Shoulder within Median or Gore)

Median (Other than Median within Gore)

Outside Shoulder-Left

Outside Shoulder-Right

Off Roadway-Location Unknown

Gore (Area between Ramp & Highway)

On Ramp

Unknown

Traffic Control	
Unit Number	Unit Number
<input checked="" type="checkbox"/> 2	<input checked="" type="checkbox"/> 1
<input type="checkbox"/> 3	<input type="checkbox"/> 3
<input type="checkbox"/> 4	<input type="checkbox"/> 4
<input type="checkbox"/> 5	<input type="checkbox"/> 5
<input type="checkbox"/> 6	<input type="checkbox"/> 6
<input type="checkbox"/> 7	<input type="checkbox"/> 7
<input type="checkbox"/> 8	<input type="checkbox"/> 8
<input type="checkbox"/> 9	<input type="checkbox"/> 9
<input type="checkbox"/> 10	<input type="checkbox"/> 10
<input type="checkbox"/> 11	<input type="checkbox"/> 11
<input type="checkbox"/> 12	<input type="checkbox"/> 12
<input type="checkbox"/> 13	<input type="checkbox"/> 13
<input type="checkbox"/> 14	<input type="checkbox"/> 14
<input type="checkbox"/> 15	<input type="checkbox"/> 15
<input type="checkbox"/> 16	<input type="checkbox"/> 16
<input type="checkbox"/> 17	<input type="checkbox"/> 17
<input type="checkbox"/> 18	<input type="checkbox"/> 18
<input type="checkbox"/> 19	<input type="checkbox"/> 19
<input type="checkbox"/> 20	<input type="checkbox"/> 20

0123012

Officer's Opinion of Possible Contributing Circumstances

Document Number Override

Driver Factors	
Unit Number	Unit Number
1 2 3 4 5 6 7 8 9 10 N/A	1 2 3 4 5 6 7 8 9 10 N/A
1 Exceeding Speed Limit	1
2 Speed too Fast/Condition	2
3 Fail to Yield Right of Way	3
4 Inattentive Driving	4
5 Following too Close	5
6 Improper Turn	6
7 Left of Center	7
8 Disregarded Traffic Control	8
9 Improper Overtaking	9
10 Unsafe Backing	10
11 Failure to have Control	11
12 Driver Condition	12
13 Physically Disabled	13
14 Other	14

Vehicle Factors	
Unit Number	Unit Number
1 2 3 4 5 6 7 8 9 10 N/A	1 2 3 4 5 6 7 8 9 10 N/A
1 Brake System	1
2 Tires	2
3 Steering System	3
4 Turn Signals	4
5 Head Lamps	5
6 Stop Lamps	6
7 Tail Lamps	7
8 Disabled in Prior Accident	8
9 Other Disabled	9
10 Mirrors	10
11 ~ Suspension System	11
12 Other	12

Highway Factors	
Unit Number	Unit Number
1 2 3 4 5 6 7 8 9 10 N/A	1 2 3 4 5 6 7 8 9 10 N/A
1 Snow, Ice or Wet	1
2 Narrow shoulder	2
3 Low Shoulder	3
4 Soft Shoulder	4
5 Loose Gravel	5
6 Rough Pavement	6
7 Debris from Prior Accident	7
8 Other Debris	8
9 Sign Obscured or Missing	9
10 Narrow Bridge	10
11 Construction Zone	11
12 Visibility Obscured	12
13 Other	13

OFFICER INFORMATION

Last	First	M.I.
Pfeiffer	Jim	E.
Law Enforcement Agency Address		
P.O. Box [redacted]		
City & State		ZIP
Fond Du Lac WI		54935
Phone Number		
[redacted]		
Agency #	Enforcement Agency #	Officer ID #
[redacted]	Fond Du Lac Sheriff 50	

Date Notified			Time Notified (Military Time)		Time Arrived (Military Time)		Date of Report		
MONTH	DAY	YEAR	HOUR	MIN.	HOUR	MIN.	MONTH	DAY	YEAR
Jan							Jan		
Feb	12	99	21	45	21	51	Feb	12	99
Mar							Mar		
Apr							Apr		
May							May		
June							June		
July							July		
Aug							Aug		
Sept							Sept		
Oct							Oct		
Nov							Nov		
Dec							Dec		

Truck & Bus Accident Information (This Section Must Be Completed for Each Truck or Bus Involved in this Accident.)

When To Use This Section: *Did the accident involve...*

Part A

A truck with at least two axles and six tires?

A truck with a hazardous materials placard?

A bus designed to carry 16 or more persons, including the driver?

STOP! If all the responses to Part A are "NO" do not complete this Truck & Bus Accident Information Section. If there are any "YES" answers, continue to Part B.

Part B

Any person who was fatally injured?

Any injured person requiring transport for immediate medical treatment?

One or more vehicles that had to be towed from the scene as a result of the accident?

STOP! If all the responses to Part B are "NO" do not continue. If there are any "YES" answers, please complete this Truck & Bus Accident Information Section...

Hazardous Material Information

- Hazardous Material Class Numbers (1-2 digit):
- Hazardous Material "UN" Numbers (4 digit):
- Hazardous Material Placard Displayed?
- Hazardous Cargo was Released?

List the Hazardous Material(s) by name in this load:

List the Name(s) of Released Hazardous Material(s):

Carrier Information	Carrier Identification Numbers	Source:
• Interstate Carrier? <input type="checkbox"/>	US DOT <input type="text"/>	Vehicle Side Shipping Papers
Carrier Name <input type="text"/>	ICC MC <input type="text"/>	Trip Manifest
	Carrier Address <input type="text"/>	Driver Log Book

Vehicle Information	Gross Vehicle Weight Rating	LBS	Total # of Axles
SEQUENCE OF EVENTS FOR THIS VEHICLE			
1 Ran off Road	2 Collision involving motor vehicle in transp.	3	4
2 Jackknife	3 Collision involving parked motor vehicle	4	5
3 Overturn (Rollover)	4 Collision involving train	5	6
4 Downhill Runaway	5 Collision involving pedalcycle	6	7
5 Cargo Loss or Shift	6 Collision involving animal	7	8
6 Explosion or Fire	7 Collision involving fixed object	8	9
7 Separation of Units	8 Collision involving other object	9	10
8 Collision involving pedestrian	9 Other	10	11

FOND DU LAC COUNTY SHERIFF'S DEPARTMENT

Gary M. Pucker
Sheriff

Mylan C. Fink, Jr.
Chief Deputy

S Macy Street
P.O. Box
Fond du Lac
Wisconsin 54936-1273
Fax (

FAX COVER SHEET

DATE: 05/13/99 3:30 AM PM
TO: Deputy Cosborn
DEPARTMENT: Manitowoc County Sheriff's Office
FAX PHONE: [REDACTED]

TOTAL NUMBER OF PAGES INCLUDING THIS COVER SHEET: 4

THIS TRANSMISSION SENT BY: Marge Hornes

IF YOU DID NOT RECEIVE ALL OF THE PAGES OR FIND THEY ARE
ILLEGIBLE, PLEASE CALL AS SOON AS POSSIBLE ~~XXXXXXXXXXXX~~
THANK YOU.

Incident Report COUNTY FDL SHERIFF'S DEPARTMEN 99-016560-I

Incident No 99-016560-I	Date & Time Reported 05/13/1999 10:06	Offense: 520 INFORMATION
Occurred From: 05/13/1999 10:06	Occurred Until: 05/13/1999 10:06	Incident Location [REDACTED] VAN DYNE RD/MELODY LA
Current Disp NON-UCR	Disposed To OTHER MTSO	Municipality FOND DU LAC
Disposition Date 05/13/1999	Juveniles Only? NO	District 11
Photos? NO	Consent? NO	Affidavit? NO
Officer Assigned 70 HARDGROVE, MICHAEL R	TTY Sent? NO	Cancelled? NO
	Optional Date/Time / / 00:00	TTY number
	Investigating Officer	

P E R S O N S	Name/Address/Phone	Description
	BALTHAZOR, BRUCE E [REDACTED] WISCONSIN AV N FOND DU LAC WI 54937 ([REDACTED]) ([REDACTED])	Born [REDACTED] MALE Hgt. 0' 0" WHITE Wgt. 0 NON-HISP Hair Eyes
	COMPLAINT 520 INFORMATION 05/13/1999	
	FARROW, BENJAMIN J [REDACTED] RIVERSIDE DR KAUKAUNA WI 54130 ([REDACTED])	Born [REDACTED] MALE Hgt. 0' 0" UNKNOWN Wgt. 0 Hair Eyes
	SUBJECT 520 INFORMATION 05/13/1999	
	LYLES AUTO BODY & TOWING SERVICE [REDACTED] VAN DYNE RD FOND DU LAC WI 54937 ([REDACTED])	Born / / BUSINESS Hgt. 0' 0" Wgt. 0 Hair Eyes
OTHER 520 INFORMATION 05/13/1999		

Description/Name/Comments	Make/Model/Stat	Serial No./Qty/Value
NO PROPERTY		
Status/Plate Type/VIN	Reg/Evid/Value	Description
NO VEHICLES		
Category	Description	
NO M.O. INFORMATION		

Continued COUNTY FDL SHERIFF'S DEPARTMEN 99-016560-I

Incident No	Date & Time Reported	Offense: 520
99-016560-I	05/13/1999 10:06	INFORMATION

N TAKEN FROM WORDPERFECT DOCUMENT 99016560.001

A
R On this date and time I, OFFICER MIKE HARDGROVE, responded to
R Lyle's Towing reference some information regarding a vehicle and a
A news broadcast from the Sheboygan or Manitowoc County area.

T
I Upon my arrival I met with the complainant, BRUCE BALTHAZOR,
V who indicated to me that on 02/12/99, at approximately 10:30 p.m.,
E he worked an accident at U.S. Highway 41 and State Highway 175. He
indicated it involved a 1983 Chevrolet van. He also produced a
Wisconsin title listing the vehicle to WILLIAM J. FARROW, out of
Kaukauna, Wisconsin. MR. BALTHAZOR continued on indicating that at
the scene he never found much of the grille unless it was destroyed
in small pieces or lost in the snow but he remembered seeing the
news broadcast and a most recent one about a fatality involving a
vehicle that matches this description in the Sheboygan or Manitowoc
County area. He also mentioned that the driver was a student from
Kaukauna traveling back and forth to Chicago. With that he's been
concerned that could this be related or not. With that I informed
MR. BALTHAZOR that I did remember reading about such an accident
and believed it to be in the Manitowoc County area. At this time
the vehicle is still at Lyle's Towing due to the fact that
basically he purchased the vehicle from the owner for parts and use
of the motor. With that we went out and looked at the vehicle in
question and there was damage to the left front and around the
sides of the vehicle which appeared to be somewhat old but again,
this accident occurred on 02/12/99.

I then informed the complainant that I would forward this
information on to the appropriate authorities and they would most
likely be in contact with him and wish to look at the vehicle. At
this time I was informed that the vehicle would remain where it is
and has been since the time of the accident.

With that I then made contact with the Manitowoc County
Sheriff's Office at approximately 10:55 a.m. this date, 05/13/99,
and I spoke with a Deputy Inspector from Manitowoc County Sheriff.
I informed him of the information I had received from MR.
BALTHAZOR, indicating that he's not certain whether it's anything
or nothing. I did give the Deputy Inspector the complainant's
information over the phone, as well as the vehicle description and
the previous owner. I also indicated that there is an accident
report on file which would be attached to the report as well as a
copy available for their use if they needed it. With that the
Deputy Inspector indicated that the officer working this particular
case was in fact working this date and he would notify him of this
information. I informed the Deputy Inspector that at this time I
would compile a report of my information along with a copy of the
accident report and have it sent to their department. I also gave
the Deputy Inspector the verbal information of where Lyle's was
located and directions of how to get to his place of business in
the event that he made the trip this day.

Continued

COUNTY FDL SHERIFF'S DEPARTMEN

99-016560-I

Incident No 99-016560-I	Date & Time Reported 05/13/1999 10:06	Offense: 520 INFORMATION
----------------------------	--	-----------------------------

N
A
R
R
A
T
I
V
E

Again, attached to this report is a copy of the accident for my record. One copy has been faxed to the Manitowoc County Sheriff's Office reference this incident.

OFFICER HARDGROVE/#70

MH/mh

1. CASE # S99 No 03905	2. CLASSIFICATION 6.310.11	3. CENSUS 6.0000
4. INCIDENT CS / S99-00242		
5. INCIDENT LOCATION		
6. NAME - LAST - FIRST - MI ANONY. (2)	7 D.O.B.	
8. ADDRESS	9. TX-HOME	
11. CITY	STATE	ZIP
10. TX-BUSINESS		
12. DETAILS SEE ATTACHED WORKSHEET.		

1749
05-19-99

MANITOWOC COUNTY SHERIFF INCIDENT CARD		
18. ASSIGNED MISO Jost		9/2/99 4/19
19. REC. BY 938	20. DIS. BY	22. TYPE OF REPORT ① INCIDENT 2. ACCIDENT 3. CITATION 4. NONE
21. HOW REC'D. 1. 911 2. POLICE RADIO ③ PHONE 4. TTY 5. IN PERSON 6. ON VIEW 7. OFF. OFF DUTY 8. C.B. RADIO 9. OTHER		23. STATUS 1. UNFOUNDED 2. PNL ③ OTHER 4. CLEARED 5. EXCEPT CLEARED
21A. M.O.		24. DATE CLEARED 05/21/99
		25. OFFENSE TYPE 1. ADULT <input type="checkbox"/> NA C 2. JUVENILE <input type="checkbox"/> 3. UNKNOWN <input type="checkbox"/>

ACTIVE

39. (CODE S-SUSPECT W-WITNESS V-VICTIM O-OTHER)	40. NAME-LAST	FIRST	MI	41. D.O.B.	42. ADDRESS	43. TELEPHONE
0	KNAPP 419	KENNETH	D		E River St, Two Rivers	
0	PULS 21990	MELISSA	A		E River St, Two Rivers	
0	KNAPP 419	THOMAS	C		Chicago St, Manitowoc	

05/21/99: I, Deputy Jost, first of all made contact with KENNETH KNAPP'S mother in Francis Creek. The Grimestopper report indicated that KENNETH had been having a ~~the~~ conversation at the speed races on 05/15/99. Reportedly the vehicle in question was in the garage at KENNETH'S mother's residence in Francis Creek. I checked that location and was unable to find any vehicle that would be what we were looking for.

I then made phone contact with MELISSA PULS, who is now residing with KENNETH in Two Rivers. MELISSA told me that they had not been to the races in over 1 year. This was later verified by KENNETH who told me the same thing. Both subjects advised me that KENNETH'S brother, THOMAS, would possibly have been at the races on 05/15/99.

05/25/99: I spoke with THOMAS and advised him of the complaint. It should be noted that both KENNETH and THOMAS showed their disgust, verbally, by telling me they were sick of being investigated for this accident. The situation was explained to them and they seemed to understand.

THOMAS told me that he was in fact at the races on 05/15/99. He told me that he had had a ~~the~~ conversation with a subject there who questioned him about his brother. THOMAS told me that the conversation included information about the Chevy van that KENNETH used to own. This subject apparently specifically questioned him as to whether or not KENNETH had struck the subject. THOMAS stated the conversation was specifically about the van and he does not remember anything said about a party happening on the south side of Manitowoc or anyone hitting a dog.

Based on this information and the previous investigation regarding the van this report can be closed out. No follow up will need to be done. JJost /eco

45. IF COMPLAINANT DIFFERENT THEN CALLER, ENTER NAME, ADDRESS, D.O.B., TELEPHONE.

46. IF CODE O (OTHER) IS USED IN FIELD #39, EXPLAIN.

INCIDENT REPORT: NOTE: IF SECTION 22 ABOVE HAS NUMBER 4 CHECKED, DO NOT GO BEYOND THIS LINE WITHOUT RECORDS SECTION BEING ADVISED, OR NO RECORD ENTRIES WILL BE MADE BELOW THIS LINE.

PROPERTY VALUE	26. PROPERTY	A. CURRENCY	B. JEWELRY	C. FURS CLOTHING	D. VEHICLE (LOCAL)	E. OFFICE EQUIPMENT	F. RADIO, TV CAMERAS	G. FIREARMS	H. HOUSEHOLD GOODS
	STOLEN	\$	\$	\$	\$	\$	\$	\$	\$
	RECOVERED	\$	\$	\$	\$	\$	\$	\$	\$
	26. PROPERTY	I. CONSUMABLES	J. LIVESTOCK	K. DRUGS	L. MARINE ITEMS	M. CONSTRUCTION ITEMS	N. LAWN AND GARDEN	O. SPORTING GOODS	P. MISC BICYCLE
	STOLEN	\$	\$	\$	\$	\$	\$	\$	\$
	RECOVERED	\$	\$	\$	\$	\$	\$	\$	\$

27. PROPERTY RECOVERED: LOCALLY _____ OTHER JURISDICTION _____ (INSERT O OR L)

PROPERTY ITEMIZATION	PROPERTY STOLEN/RECOVERED ITEMIZATION, USE THE FOLLOWING FORMAT				
	28. QUANTITY	29. ARTICLE NAME	30. BRAND NAME	31. SERIAL NUMBER	32. CODE
					S R <input type="checkbox"/> <input type="checkbox"/>
					S R <input type="checkbox"/> <input type="checkbox"/>
					S R <input type="checkbox"/> <input type="checkbox"/>
					S R <input type="checkbox"/> <input type="checkbox"/>
					S R <input type="checkbox"/> <input type="checkbox"/>

33. PROPERTY DAMAGE AMOUNT \$ _____ 34. INSURANCE COMPANY _____

35. OFFICER ASSAULTED Y N 36. ARSON Y N 37. STRUCTURE CODE _____ 38. DAMAGE \$ _____

47. CIB	ENTERED <input type="checkbox"/>	CANCELLED <input type="checkbox"/>	48. TOTAL AMOUNT PROPERTY STOLEN \$ _____
NCIC	<input type="checkbox"/>	<input type="checkbox"/>	
OTHER BROADCAST	<input type="checkbox"/>	<input type="checkbox"/>	
			49. TOTAL AMOUNT PROPERTY RECOVERED \$ _____

50. IS REPORT CONTINUED? YES NO 51. CAUTION INDICATORS, ATLS ETC.

52. DATA PROCESS INFORMATION:

COMPUTER ENTERED DATE 16 09 99

MICROFILM INDEXED INITIAL AS

IS CASE CLASSIFICATION CORRECT? (Y) N N
IF N HAS CORRECTION BEEN MADE?

53. FILE APPROVAL
BY [Signature] DATE 052799

1. CASE # S99 No 03925 | 2. CLASSIFICATION 63011 | 3. CENSUS 701000

4. INCIDENT CS/S99-00242

5. INCIDENT LOCATION CTH. CR

6. NAME- LAST-FIRST-MI SBSO 156 | 7. D.O.B.

8. ADDRESS DEP. O'MALLEY | 9. TX-HOME

11. CITY STATE ZIP | 10. TX-BUSINESS

12. DETAILS Report of a vehicle w/o a grill RP#FYZ-180
86 full size Chev PU.

052099 1400

14. REC'D #	15. DISP	16. 10-23	17. 10-24
SUN 1	THU 5		
MON 2	FRI 6		
TUE 3	SAT 7		
WED 4			

MANITOWOC COUNTY SHERIFF
INCIDENT CARD

18. ASSIGNED MTSO | 9 2 9

MTSO CS

19. REC. BY 923 | 20. DIS. BY 923 | 22. TYPE OF REPORT
 1. INCIDENT
 2. ACCIDENT
 3. CITATION
 4. NONE

21. HOW REC'D.
 1. 911
 2. POLICE RADIO
 3. PHONE
 4. TTY
 5. IN PERSON
 6. ON VIEW
 7. OFF. OFF DUTY
 8. C.B. RADIO
 9. OTHER

23. STATUS
 1. UNFOUNDED
 2. RNL
 3. OTHER
 4. CLEARED
 5. EXCEPT CLEARED

24. DATE CLEARED 052199

25. OFFENSE TYPE
 1. ADULT NA
 2. JUVENILE
 3. UNKNOWN

ACTIVE

39. (CODE S-SUSPECT W-WITNESS V-VICTIM O-OTHER)							
CODE	40. NAME-LAST	FIRST	MI	41. D.O.B.	42. ADDRESS	43. TELEPHONE	
0	FOLYER	ARLENE	L		Sebald Rd, Elkhart Lake		
0	FOLYER	MARY	J		P.O. Box , Sharon		

05/20/99: I, Deputy Jost, conducted follow up in reference to this complaint. MTSO had received a Crimestoppers complaint indicating that an officer from SBSO had observed a 1986 full-size Chevy pick up truck bearing RP FYZ180, this vehicle not having any grill in the front of it.

I made phone contact with the owner, MARY FOLYER, and she reported that her daughter-in-law, ARLENE FOLYER, had the vehicle. I then made phone contact with ARLENE.

05/21/99: Deputy Colborn met with ARLENE in Kiel to inspect the vehicle. Deputy Colborn advised me that the grill was missing on the truck, however, there was no other damage that resembled what we were looking for. Deputy Colborn advised me that there was no damage to the fan shroud, no damage to the windshield, and no damage to the hood area. In looking over the vehicle Deputy Colborn advised me he did not feel that this was the vehicle we were looking for reference the accident.

This report can be closed out with no follow up needed. JJost  eco

45. IF COMPLAINANT DIFFERENT THEN CALLER, ENTER NAME, ADDRESS, D.O.B., TELEPHONE.

46. IF CODE O (OTHER) IS USED IN FIELD #39, EXPLAIN.

INCIDENT REPORT: NOTE: IF SECTION 22 ABOVE HAS NUMBER 4 CHECKED, DO NOT GO BEYOND THIS LINE WITHOUT RECORDS SECTION BEING ADVISED, OR NO RECORD ENTRIES WILL BE MADE BELOW THIS LINE.

PROPERTY VALUE	26. PROPERTY	A. CURRENCY	B. JEWELRY	C. FURS CLOTHING	D. VEHICLE (LOCAL)	E. OFFICE EQUIPMENT	F. RADIO, TV CAMERAS	G. FIREARMS	H. HOUSE-HOLD GOODS
	STOLEN	\$	\$	\$	\$	\$	\$	\$	\$
	RECOVERED	\$	\$	\$	\$	\$	\$	\$	\$
	26. PROPERTY	I. CONSUMABLES	J. LIVESTOCK	K. DRUGS	L. MARINE ITEMS	M. CONSTRUCTION ITEMS	N. LAWN AND GARDEN	O. SPORTING GOODS	P. MISC BICYCLE
STOLEN	\$	\$	\$	\$	\$	\$	\$	\$	
RECOVERED	\$	\$	\$	\$	\$	\$	\$	\$	

27. PROPERTY RECOVERED: LOCALLY _____ OTHER JURISDICTION _____ (INSERT O OR L)

PROPERTY ITEMIZATION	PROPERTY STOLEN/RECOVERED ITEMIZATION, USE THE FOLLOWING FORMAT				
	28. QUANTITY	29. ARTICLE NAME	30. BRAND NAME	31. SERIAL NUMBER	32. CODE
					S <input type="checkbox"/> R <input type="checkbox"/>
					S <input type="checkbox"/> R <input type="checkbox"/>
					S <input type="checkbox"/> R <input type="checkbox"/>
					S <input type="checkbox"/> R <input type="checkbox"/>

33. PROPERTY DAMAGE AMOUNT \$ _____

34. INSURANCE COMPANY _____

35. OFFICER ASSAULTED Y N

36. ARSON Y N

37. STRUCTURE CODE _____

38. DAMAGE \$ _____

47. CIB ENTERED CANCELLED
 NCIC
 OTHER BROADCAST

48. TOTAL AMOUNT PROPERTY STOLEN \$ _____

49. TOTAL AMOUNT PROPERTY RECOVERED \$ _____

50. IS REPORT CONTINUED? YES NO

51. CAUTION INDICATORS, ATLS ETC.

52. DATA PROCESS INFORMATION:

COMPUTER ENTERED DATE 15/01/99
 MICROFILM INDEXED INITIAL KS

53. FILE APPROVAL

IS CASE CLASSIFICATION CORRECT? Y N
 IF N HAS CORRECTION BEEN MADE? Y N

BY GK DATE 05/27/99

1. CASE # S99 No 04116 | 2. CLASSIFICATION 6310.11 | 3. CENSUS 5210.00

4. INCIDENT CS / 599-00242

5. INCIDENT LOCATION CTH CR

6. NAME LAST, FIRST, MI [REDACTED] 7. D.O.B. 1296 [REDACTED]

8. [REDACTED] 9. [REDACTED] 10. TX-BUSINESS [REDACTED]

11. STATE ZIP [REDACTED]

12. DETAILS
 Seeing a blue Suburban operating in Neenah-Menasha area male oper. Newly painted missing grill. RP.# NEWCARE

0831
052877

MANITOWOC COUNTY SHERIFF INCIDENT CARD

18. ASSIGNED
 MTSO CS 929

19. REC. BY 923 | 20. DIS. BY

21. HOW REC'D.
 1. 911
 2. POLICE RADIO
 3. PHONE
 4. TTY
 5. IN PERSON
 6. ON VIEW
 7. OFF. OFF DUTY
 8. C.B. RADIO
 9. OTHER

22. TYPE OF REPORT
 1. INCIDENT
 2. ACCIDENT
 3. CITATION
 4. NONE

23. STATUS
 1. UNFOUNDED
 2. PNL
 3. OTHER
 4. CLEARED
 5. EXCEPT CLEARED

24. DATE CLEARED 15/17/00

25. OFFENSE TYPE
 1. ADULT NA
 2. JUVENILE
 3. UNKNOWN

14. REC'D. 15. DISP. 16. 10-23 17. 10-24

13. DAY
 SUN 1 THU 5
 MON 2 FRI 6
 TUE 3 SAT 7
 WED 4

39. (CODE S-SUSPECT W-WITNESS V-VICTIM O-OTHER)

CODE	40. NAME-LAST	FIRST	MI	41. D.O.B.	42. ADDRESS	43. TELEPHONE

45. IF COMPLAINANT DIFFERENT THEN CALLER, ENTER NAME, ADDRESS, D.O.B., TELEPHONE.

46. IF CODE O (OTHER) IS USED IN FIELD #39, EXPLAIN.

INCIDENT REPORT: NOTE: IF SECTION 22 ABOVE HAS NUMBER 4 CHECKED, DO NOT GO BEYOND THIS LINE WITHOUT RECORDS SECTION BEING ADVISED, OR NO RECORD ENTRIES WILL BE MADE BELOW THIS LINE.

PROPERTY VALUE	26. PROPERTY	A. CURRENCY	B. JEWELRY	C. FURS CLOTHING	D. VEHICLE (LOCAL)	E. OFFICE EQUIPMENT	F. RADIO, TV CAMERAS	G. FIREARMS	H. HOUSE-HOLD GOODS
	STOLEN	\$	\$	\$	\$	\$	\$	\$	\$
	RECOVERED	\$	\$	\$	\$	\$	\$	\$	\$
	26. PROPERTY	I. CONSUMABLES	J. LIVESTOCK	K. DRUGS	L. MARINE ITEMS	M. CONSTRUCTION ITEMS	N. LAWN AND GARDEN	O. SPORTING GOODS	P. MISC BICYCLE
	STOLEN	\$	\$	\$	\$	\$	\$	\$	\$
	RECOVERED	\$	\$	\$	\$	\$	\$	\$	\$

27. PROPERTY RECOVERED: LOCALLY _____ OTHER JURISDICTION _____ (INSERT O OR L)

PROPERTY ITEMIZATION	PROPERTY STOLEN/RECOVERED ITEMIZATION, USE THE FOLLOWING FORMAT				
	28. QUANTITY	29. ARTICLE NAME	30. BRAND NAME	31. SERIAL NUMBER	32. CODE
					S R <input type="checkbox"/> <input type="checkbox"/>
					S R <input type="checkbox"/> <input type="checkbox"/>
					S R <input type="checkbox"/> <input type="checkbox"/>
					S R <input type="checkbox"/> <input type="checkbox"/>

33. PROPERTY DAMAGE AMOUNT \$ _____

34. INSURANCE COMPANY _____

35. OFFICER ASSAULTED Y N

36. ARSON Y N

37. STRUCTURE CODE _____

38. DAMAGE \$ _____

47. CIB ENTERED CANCELLED
 NCIC
 OTHER BROADCAST

48. TOTAL AMOUNT PROPERTY STOLEN \$ _____

49. TOTAL AMOUNT PROPERTY RECOVERED \$ _____

50. IS REPORT CONTINUED? YES NO

51. CAUTION INDICATORS, ATLS ETC.

52. DATA PROCESS INFORMATION:

COMPUTER ENTERED DATE 5/17/00

MICROFILM INDEXED INITIAL AS

IS CASE CLASSIFICATION CORRECT? Y N
 IF N HAS CORRECTION BEEN MADE? Y N

53. FILE APPROVAL

BY AS

DATE 05/16/00

1. CASE # S99 No 04153 | 2. CLASSIFICATION 63011 | 3. CENSUS 141002

4. INCIDENT CS 599-00242

5. INCIDENT LOCATION OTH CR

6. NAME LAST FIRST MI [REDACTED] | 7. D.O.B. [REDACTED]

8. ADDRESS [REDACTED] | 9. TX-HOME [REDACTED]

11. CITY STATE ZIP | 10. TX-BUSINESS [REDACTED]

12. DETAILS
 Caller's daughter rec'd info that a [REDACTED] (not sure of spelling) suspects his landlord may have been involved in the fatal hit & run

052999 1106

MANITOWOC COUNTY SHERIFF
INCIDENT CARD

18. ASSIGNED MTS0929

19. REC. BY 920	20. DIS. BY	22. TYPE OF REPORT ① INCIDENT 2. ACCIDENT 3. CITATION 4. NONE
21. HOW REC'D. 1. 911 2. POLICE RADIO 3. PHONE 4. TTY 5. IN PERSON 6. ON VIEW 7. OFF. OFF DUTY 8. C.B. RADIO 9. OTHER		23. STATUS 1. UNFOUNDED 2. PNL 3. OTHER 4. CLEARED 5. EXCEPT CLEARED
21A. M.O.		24. DATE CLEARED 07/02/99
		25. OFFENSE TYPE 1. ADULT <input type="checkbox"/> NA <input type="checkbox"/> 2. JUVENILE <input type="checkbox"/> 3. UNKNOWN <input type="checkbox"/>

39. (CODE S-SUSPECT W-WITNESS V-VICTIM O-OTHER)						
CODE	40. NAME-LAST	FIRST	MI	41. D.O.B.	42. ADDRESS	43. TELEPHONE
S	BUTZ	ROY	M.	19929	RANGELINE RD. KOHLER	[REDACTED]

05-29-99 cont'd

due to the fact that he hasn't seen nor heard from his landlord since the time of the accident - doesn't even know where to send rent money. This landlord does reportedly own a Chev truck which would match the hit & run vehicle description. Galler suggests we contact [REDACTED] for more info. [REDACTED] lives in the rural Kiel area, and works for Kohler Co. as an electrician. sbraun920

06/29/99 Complaint same as S99-04130, followup there. M.J. Bushman
CLOSE OUT

45. IF COMPLAINANT DIFFERENT THEN CALLER, ENTER NAME, ADDRESS, D.O.B., TELEPHONE.

46. IF CODE O (OTHER) IS USED IN FIELD #39, EXPLAIN.

INCIDENT REPORT: NOTE: IF SECTION 22 ABOVE HAS NUMBER 4 CHECKED, DO NOT GO BEYOND THIS LINE WITHOUT RECORDS SECTION BEING ADVISED, OR NO RECORD ENTRIES WILL BE MADE BELOW THIS LINE.

PROPERTY VALUE	26. PROPERTY	A. CURRENCY	B. JEWELRY	C. FURS CLOTHING	D. VEHICLE (LOCAL)	E. OFFICE EQUIPMENT	F. RADIO, TV CAMERAS	G. FIREARMS	H. HOUSE-HOLD GOODS
	STOLEN	\$	\$	\$	\$	\$	\$	\$	\$
	RECOVERED	\$	\$	\$	\$	\$	\$	\$	\$
	26. PROPERTY	I. CONSUM-ABLES	J. LIVESTOCK	K. DRUGS	L. MARINE ITEMS	M. CONSTRUCTION ITEMS	N. LAWN AND GARDEN	O. SPORTING GOODS	P. MISC BICYCLE
	STOLEN	\$	\$	\$	\$	\$	\$	\$	\$
	RECOVERED	\$	\$	\$	\$	\$	\$	\$	\$

27. PROPERTY RECOVERED: LOCALLY _____ OTHER JURISDICTION _____ (INSERT O OR L)

PROPERTY ITEMIZATION	PROPERTY STOLEN/RECOVERED ITEMIZATION, USE THE FOLLOWING FORMAT				
	28. QUANTITY	29. ARTICLE NAME	30. BRAND NAME	31. SERIAL NUMBER	32. CODE
					S R <input type="checkbox"/> <input type="checkbox"/>
					S R <input type="checkbox"/> <input type="checkbox"/>
					S R <input type="checkbox"/> <input type="checkbox"/>
					S R <input type="checkbox"/> <input type="checkbox"/>

33. PROPERTY DAMAGE AMOUNT \$ _____ 34. INSURANCE COMPANY _____

35. OFFICER ASSAULTED Y N 36. ARSON Y N 37. STRUCTURE CODE _____ 38. DAMAGE \$ _____

47. CIB	ENTERED <input type="checkbox"/>	CANCELLED <input type="checkbox"/>	48. TOTAL AMOUNT PROPERTY STOLEN \$ _____
NCIC	<input type="checkbox"/>	<input type="checkbox"/>	
OTHER BROADCAST	<input type="checkbox"/>	<input type="checkbox"/>	
			49. TOTAL AMOUNT PROPERTY RECOVERED \$ _____

50. IS REPORT CONTINUED? YES NO 51. CAUTION INDICATORS, ATLS ETC.

52. DATA PROCESS INFORMATION:
 COMPUTER ENTERED DATE 7.16.99
 MICROFILM INDEXED INITIAL AS
 IS CASE CLASSIFICATION CORRECT? N
 IF N HAS CORRECTION BEEN MADE? N

53. FILE APPROVAL
 BY [Signature] DATE 06.02.99

1. CASE # **S99 No 04272** 2. CLASSIFICATION **630.1** 3. CENSUS **53000**

4. INCIDENT **CS/599-00242**

5. INCIDENT LOCATION

6. NAME - LAST-FIRST-MI **Reimer John/TRPD** 7. D.O.B.

8. ADDRESS 9. TX-HOME

11. CITY **TR** STATE ZIP 10. TX-BUSINESS

12. DETAILS **recd info from TRPD to ck on a veh**

060199 2030

14. REC'D 15. DISP 16. 10-23 17. 10-24
 13. DAY
 SUN 1 THU 5
 MON 2 FRI 6
 TUE 3 SAT 7
 WED 4

MANITOWOC COUNTY SHERIFF INCIDENT CARD

18. ASSIGNED **MT50** **929**

19. REC. BY **929** 20. DIS. BY
 21. HOW REC'D.
 1. 911
 2. POLICE RADIO
 3. PHONE
 4. TTY
 5. IN PERSON
 6. ON VIEW
 7. OFF. OFF DUTY
 8. C.B. RADIO
 9. OTHER
 21A. M.O.
 22. TYPE OF REPORT
 1. INCIDENT
 2. ACCIDENT
 3. CITATION
 4. NONE
 23. STATUS
 1. UNFOUNDED
 2. PNL
 3. OTHER
 4. CLEARED
 5. EXCEPT CLEARED
 24. DATE CLEARED **06/04/99**
 25. OFFENSE TYPE
 1. ADULT NA
 2. JUVENILE
 3. UNKNOWN

39. (CODE S-SUSPECT W-WITNESS V-VICTIM O-OTHER)				41. D.O.B.		42. ADDRESS		43. TELEPHONE
CODE	40. NAME-LAST	FIRST	MI					
0	REICH	THOMAS	J.	1965		24TH ST. TWO RIVERS		

05/21/99 @ 0224 Hrs.: Upon returning to work I, Lt. Bushman, received a 10-27 on WI RP AH47624, which is a truck plating, stating no record of this plate. Officer Reimer from TRPD observed this vehicle in the City of Two Rivers, parked at [redacted] 24th St. The plates come back no record, the stickers indicated it has been expired since 1995. The VIN number comes back no record also. The vehicle is a gold and white 70's Chevrolet pick up with the entire grill missing and the passenger's side windshield broken. It would be 2-wheel drive with snow tires. It is parked at [redacted] 24th St and Officer Reimer requested that I check it for possible hit and run vehicle upon return to work.

06/01/99: Returning to work I, Lt. Bushman, did go to the address listed above and check the vehicle. I found that the tires were not a match as they were very aggressive snow and mud-type design. It appeared to be a 2-wheel drive vehicle. The bumper was white and rusted on the right side where it sustained damage from hitting something extremely solid. The entire grill was gone, however, there was no other sheet metal damage noted on the hood, the radiator, or mounting sheet metal. The vehicle had round headlights, not consistent with what we are looking for in the hit and run vehicle. None of the older rusted pieces such as the hood where one would expect damage and the inside radiator support appeared to have been replaced. The damage on the bumper looked like something solid. The grill was simply cracked and had been removed. The windshield did have some minor damage. It appears as though the passenger in the vehicle, at the time the right front damage was sustained, apparently must have flown against the windshield and cracked it from the inside out. This would not be the suspect vehicle that we are looking for. You can close out complaint. MJBushman /eco

[Handwritten signature]

71740 IN 665

45. IF COMPLAINANT DIFFERENT THEN CALLER, ENTER NAME, ADDRESS, D.O.B., TELEPHONE.

46. IF CODE O (OTHER) IS USED IN FIELD #39, EXPLAIN.

INCIDENT REPORT: NOTE: IF SECTION 22 ABOVE HAS NUMBER 4 CHECKED, DO NOT GO BEYOND THIS LINE WITHOUT RECORDS SECTION BEING ADVISED, OR NO RECORD ENTRIES WILL BE MADE BELOW THIS LINE.

PROPERTY VALUE	26. PROPERTY	A. CURRENCY	B. JEWELRY	C. FURS CLOTHING	D. VEHICLE (LOCAL)	E. OFFICE EQUIPMENT	F. RADIO, TV CAMERAS	G. FIREARMS	H. HOUSE-HOLD GOODS
	STOLEN	\$	\$	\$	\$	\$	\$	\$	\$
	RECOVERED	\$	\$	\$	\$	\$	\$	\$	\$
	26. PROPERTY	I. CONSUM-ABLES	J. LIVESTOCK	K. DRUGS	L. MARINE ITEMS	M. CONSTRUCTION ITEMS	N. LAWN AND GARDEN	O. SPORTING GOODS	P. MISC BICYCLE
	STOLEN	\$	\$	\$	\$	\$	\$	\$	\$
	RECOVERED	\$	\$	\$	\$	\$	\$	\$	\$

27. PROPERTY RECOVERED: LOCALLY _____ OTHER JURISDICTION _____ (INSERT O OR L)

PROPERTY ITEMIZATION	PROPERTY STOLEN/RECOVERED ITEMIZATION, USE THE FOLLOWING FORMAT				
	28. QUANTITY	29. ARTICLE NAME	30. BRAND NAME	31. SERIAL NUMBER	32. CODE
					S <input type="checkbox"/> R <input type="checkbox"/>
					S <input type="checkbox"/> R <input type="checkbox"/>
					S <input type="checkbox"/> R <input type="checkbox"/>
					S <input type="checkbox"/> R <input type="checkbox"/>
					S <input type="checkbox"/> R <input type="checkbox"/>

33. PROPERTY DAMAGE AMOUNT \$ _____

34. INSURANCE COMPANY _____

35. OFFICER ASSAULTED - Y N

36. ARSON Y N

37. STRUCTURE CODE _____

38. DAMAGE \$ _____

47. CIB ENTERED CANCELLED
 NCIC
 OTHER BROADCAST

48. TOTAL AMOUNT PROPERTY STOLEN \$ _____

49. TOTAL AMOUNT PROPERTY RECOVERED \$ _____

50. IS REPORT CONTINUED? YES NO

51. CAUTION INDICATORS, ATLS ETC.

52. DATA PROCESS INFORMATION:

COMPUTER ENTERED DATE 6/29/99
 MICROFILM INDEXED INITIAL KS

53. FILE APPROVAL

IS CASE CLASSIFICATION CORRECT? Y N
 IF N HAS CORRECTION BEEN MADE? Y N

BY WRS DATE 6/30/99

5-21-99 0224 hrs.

Lt. Bushman:

This info is from Officer Reimer from TRPD in regard to the H & R vehicle.

Plates come back no record. Stickers indicate expired in 95.
Vin comes back no record.

Gold/white 70'2 Chevrolet pickup with the entire grill missing
and passenger side winshield broken.

2-Wheel drive with snow tires.

Parked at [REDACTED] 24th St. Two Rivers
928

V. AGGRESSIVE SNOW/MUD RT.
BUMPER WITH REAR AT
SIDE DAMAGE GRILL GONE NO
OTHER STICKERS VEHIC DAMAGE
ON HOOD BASED ON HEIGHT
RS. HEADLAMP

1. CASE # S99 N^o 04130 2. CLASSIFICATION 6310.11 3. CENSUS 701000

4. INCIDENT CS/S99-00242

5. INCIDENT LOCATION Sheboygan

6. NAME - LAST - FIRST - MI Anonymous (2) 7. D.O.B.

8. ADDRESS 9. TX-HOME

11. CITY STATE ZIP 10. TX-BUSINESS

12. DETAILS See Attached

05/28/99 1537 66/RE/50

MANITOWOC COUNTY SHERIFF
INCIDENT CARD

18. ASSIGNED MJSO 9/29

19. REC. BY 935 20. DIS. BY

21. HOW REC'D.
1. 911
2. POLICE RADIO
3. PHONE
4. TTY
5. IN PERSON
6. ON VIEW
7. OFF. OFF DUTY
8. C.B. RADIO
9. OTHER

22. TYPE OF REPORT
1. INCIDENT
2. ACCIDENT
3. CITATION
4. NONE

23. STATUS
1. UNFOUNDED
2. PNL
3. OTHER
4. CLEARED
5. EXCEPT CLEARED

24. DATE CLEARED 5/17/00

25. OFFENSE TYPE
1. ADULT NA
2. JUVENILE
3. UNKNOWN

14. REC'D
15. DISP
16. 10-23
17. 10-24

13. DAY
SUN 1 THU 5
MON 2 FRI 6
TUE 3 SAT 7
WED 4

39. (CODE S-SUSPECT W-WITNESS V-VICTIM O-OTHER)

CODE	40. NAME - LAST	FIRST	MI	41. D.O.B.	42. ADDRESS	43. TELEPHONE
S	BUTZ ROY M.				RANGELTIVE RD. KOKKEUL	
O	Butz, Roy	Sr.			Mockingbird Ln., Fond Du Lac	

06/29/99 Roy M. Butz information listed above, DHAS indicates one vehicle registered to him, an 87 Olds, no Chev. truck.
As Interview report indicates Butz did go to jail in Sheboygan for his third OWI arrest and served time of 60 days under Huber and Good time, from 11/12/98 through 12/27/98. Listed next of kin Roy Butz Senior.

45. IF COMPLAINANT DIFFERENT THEN CALLER, ENTER NAME, ADDRESS, D.O.B., TELEPHONE.

46. IF CODE O (OTHER) IS USED IN FIELD #39, EXPLAIN.

INCIDENT REPORT: NOTE: IF SECTION 22 ABOVE HAS NUMBER 4 CHECKED, DO NOT GO BEYOND THIS LINE WITHOUT RECORDS SECTION BEING ADVISED, OR NO RECORD ENTRIES WILL BE MADE BELOW THIS LINE.

PROPERTY VALUE	26. PROPERTY	A. CURRENCY	B. JEWELRY	C. FURS CLOTHING	D. VEHICLE (LOCAL)	E. OFFICE EQUIPMENT	F. RADIO, TV CAMERAS	G. FIREARMS	H. HOUSE-HOLD GOODS
	STOLEN	\$	\$	\$	\$	\$	\$	\$	\$
	RECOVERED	\$	\$	\$	\$	\$	\$	\$	\$
	26. PROPERTY	I. CONSUM-ABLES	J. LIVESTOCK	K. DRUGS	L. MARINE ITEMS	M. CONSTRUCTION ITEMS	N. LAWN AND GARDEN	O. SPORTING GOODS	P. MISC BICYCLE
	STOLEN	\$	\$	\$	\$	\$	\$	\$	\$
	RECOVERED	\$	\$	\$	\$	\$	\$	\$	\$

27. PROPERTY RECOVERED: LOCALLY _____ OTHER JURISDICTION _____ (INSERT O OR L)

PROPERTY ITEMIZATION	PROPERTY STOLEN/RECOVERED ITEMIZATION, USE THE FOLLOWING FORMAT				
	28. QUANTITY	29. ARTICLE NAME	30. BRAND NAME	31. SERIAL NUMBER	32. CODE
					S R <input type="checkbox"/> <input type="checkbox"/>
					S R <input type="checkbox"/> <input type="checkbox"/>
					S R <input type="checkbox"/> <input type="checkbox"/>
					S R <input type="checkbox"/> <input type="checkbox"/>
					S R <input type="checkbox"/> <input type="checkbox"/>

33. PROPERTY DAMAGE AMOUNT \$ _____ 34. INSURANCE COMPANY _____

35. OFFICER ASSAULTED Y N 36. ARSON Y N 37. STRUCTURE CODE _____ 38. DAMAGE \$ _____

47. CIB	ENTERED <input type="checkbox"/>	CANCELLED <input type="checkbox"/>	48. TOTAL AMOUNT PROPERTY STOLEN \$ _____
NCIC	<input type="checkbox"/>	<input type="checkbox"/>	
OTHER BROADCAST	<input type="checkbox"/>	<input type="checkbox"/>	
			49. TOTAL AMOUNT PROPERTY RECOVERED \$ _____

50. IS REPORT CONTINUED? YES NO 51. CAUTION INDICATORS, ATLS ETC.

52. DATA PROCESS INFORMATION:

COMPUTER ENTERED DATE 5/17/00

MICROFILM INDEXED INITIAL AS

IS CASE CLASSIFICATION CORRECT? Y N
IF N HAS CORRECTION BEEN MADE? Y N

53. FILE APPROVAL
BY [Signature] DATE 05/16/00

1. CASE # S99 No 04667 | 2. CLASSIFICATION 6,310,11 | 3. CENSUS 14,00,2

4. INCIDENT CS/S99-00242

5. INCIDENT LOCATION CTH F .7 MILE W/O PIGEON LAKE RD.

6. NAME - LAST - FIRST - MI [REDACTED] 7. D.O.B. 24513

8. ADDRESS [REDACTED] 9. TX-HOME [REDACTED]

11. CITY [REDACTED] STATE [REDACTED] ZIP [REDACTED] 10. TX-BUSINESS [REDACTED]

12. DETAILS BROWN-RUSTY PRIMERED VAN

PARKED IN FIELD PAST 2 WKS.

COULD BE HER VEH.

1800
6-15-99
14. REC'D
15. DISP
16. 10-23
17. 10-24
13. DAY
SUN 1 THU 5
MON 2 FRI 6
TUE 3 SAT 7
WED 4

MANITOWOC COUNTY SHERIFF
INCIDENT CARD

18. ASSIGNED MTSO 9219

19. REC. BY 932 20. DIS. BY

22. TYPE OF REPORT
1. INCIDENT
2. ACCIDENT
3. CITATION
4. NONE

21. HOW REC'D.
1. 911
2. POLICE RADIO
3. PHONE
4. TTY
5. IN PERSON
6. ON VIEW
7. OFF. OFF DUTY
8. C.B. RADIO
9. OTHER

23. STATUS
1. UNFOUNDED
2. PNL
3. OTHER
4. CLEARED
5. EXCEPT CLEARED
24. DATE CLEARED 06/23/99
25. OFFENSE TYPE
1. ADULT NA
2. JUVENILE
3. UNKNOWN

ACTIVE

39. (CODE S-SUSPECT W-WITNESS V-VICTIM O-OTHER)				41. D.O.B.		42. ADDRESS		43. TELEPHONE	
CODE	40. NAME-LAST	FIRST	MI						
0	BERGNER	WILLIAM	J			W. Luebbe Lane, Milwaukee		53217	
0	BERGNER	DANIEL	W			Terrydale Dr., West Bend		53090	

06/20/99 @ 2030 hrs.: Ref. the Crime Stopper Report that a brown, rusty, primered colored van should be parked in a field approx. .7 of a mi. west of Pigeon Lake Rd. on the north side, 200 yds. off the road. I, Lt. Bushman, drove this squad to within several feet of the van, and got out and checked the vin numbers and the front end for damage. There are 2 vehicles parked back there. One is a 1978 Ford Van, registration AB 62976 coming back to WILLIAM BERGNER, and the second is a 1985 Ford Van, with no current registration plates on the vehicle, vin number shows that vehicle would come back to DANIEL W. BERGNER of West Bend. I am assuming the field that these vehicles are in, as there are several other old junk vehicles just out of view from CTH F, does belong to this BERGNER. Neither one of them would match the description of the suspect vehicle that we're looking for. You can close this complaint. MBushman /jml

1. CASE # S99 No 04828 2. CLASSIFICATION 63011 3. CENSUS 114001

MANITOWOC COUNTY SHERIFF
INCIDENT CARD

4. INCIDENT CS / 599-00242
5. INCIDENT LOCATION Hwy CR + Silver Crk Rd.

18. ASSIGNED Jost 449

6. NAME- LAST-FIRST-MI [REDACTED] 7. DOB [REDACTED]

8. ADDRESS [REDACTED] 9. TX-HOME [REDACTED]

11. CITY [REDACTED] STATE [REDACTED] ZIP [REDACTED] 10. TX-BUSINESS [REDACTED]

19. REC. BY 925 20. DIS. BY 925
22. TYPE OF REPORT
1. INCIDENT
2. ACCIDENT
3. CITATION
4. NONE

12. DETAILS
Caller saw a GMC

14. REC'D 15. DISP 16. 10-23 17. 10-24
13. DAY
SUN 1 THU 5
MON 2 FRI 6
TUE 3 SAT 7
WED 4

21. HOW REC'D.
1. 911
2. POLICE RADIO
3. PHONE
4. TTY
5. IN PERSON
6. ON VIEW
7. OFF. OFF DUTY
8. C.B. RADIO
9. OTHER
23. STATUS
1. UNFOUNDED
2. PNL
3. OTHER
4. CLEARED
5. EXCEPT CLEARED

Silver colored van at above location on a flatbed. Describes it as

24. DATE CLEARED 07/08/99
25. OFFENSE TYPE
1. ADULT NA
2. JUVENILE
3. UNKNOWN

39. (CODE S-SUSPECT W-WITNESS V-VICTIM O-OTHER)

CODE	40. NAME-LAST	FIRST	MI	41. D.O.B.	42. ADDRESS	43. TELEPHONE

a 80's model, suspects it was the vehicle involved in the Hit & Run Fatality. SESE
06-21-99 at the above times, I, Deputy Jost, located the vehicle in question. The silver colored GMC van was parked in the drive way at [REDACTED] CIH CR. I was unable to make contact at the residence as no one was home. I inspected the van and found that the damage did not coincide with damage probably done in the H and R fatatlity. The cargo area of the van was cut off the frame and only the front driver and passenger seats remained. The grill was a different style and the van was a GMC not a Chev.. The vin number on the van, [REDACTED] was run through dispatch however they were unable to get the vin to come back. No follow-up needed. [Signature] CMJ

45. IF COMPLAINANT DIFFERENT THEN CALLER, ENTER NAME, ADDRESS, D.O.B., TELEPHONE.

46. IF CODE O (OTHER) IS USED IN FIELD #39, EXPLAIN.

INCIDENT REPORT: NOTE: IF SECTION 22 ABOVE HAS NUMBER 4 CHECKED, DO NOT GO BEYOND THIS LINE WITHOUT RECORDS SECTION BEING ADVISED, OR NO RECORD ENTRIES WILL BE MADE BELOW THIS LINE.

PROPERTY VALUE	26. PROPERTY	A. CURRENCY	B. JEWELRY	C. FURS CLOTHING	D. VEHICLE (LOCAL)	E. OFFICE EQUIPMENT	F. RADIO, TV CAMERAS	G. FIREARMS	H. HOUSE-HOLD GOODS
	STOLEN	\$	\$	\$	\$	\$	\$	\$	\$
	RECOVERED	\$	\$	\$	\$	\$	\$	\$	\$
	26. PROPERTY	I. CONSUMABLES	J. LIVESTOCK	K. DRUGS	L. MARINE ITEMS	M. CONSTRUCTION ITEMS	N. LAWN AND GARDEN	O. SPORTING GOODS	P. MISC BICYCLE
	STOLEN	\$	\$	\$	\$	\$	\$	\$	\$
	RECOVERED	\$	\$	\$	\$	\$	\$	\$	\$

27. PROPERTY RECOVERED: LOCALLY _____ OTHER JURISDICTION _____ (INSERT O OR L)

PROPERTY ITEMIZATION	PROPERTY STOLEN/RECOVERED ITEMIZATION, USE THE FOLLOWING FORMAT				
	28. QUANTITY	29. ARTICLE NAME	30. BRAND NAME	31. SERIAL NUMBER	32. CODE
					S R <input type="checkbox"/> <input type="checkbox"/>
					S R <input type="checkbox"/> <input type="checkbox"/>
					S R <input type="checkbox"/> <input type="checkbox"/>
					S R <input type="checkbox"/> <input type="checkbox"/>
					S R <input type="checkbox"/> <input type="checkbox"/>

33. PROPERTY DAMAGE AMOUNT \$ _____ 34. INSURANCE COMPANY _____

35. OFFICER ASSAULTED Y N 36. ARSON Y N 37. STRUCTURE CODE _____ 38. DAMAGE \$ _____

47. CIB	ENTERED <input type="checkbox"/>	CANCELLED <input type="checkbox"/>	48. TOTAL AMOUNT PROPERTY STOLEN \$ _____
NCIC	<input type="checkbox"/>	<input type="checkbox"/>	
OTHER BROADCAST	<input type="checkbox"/>	<input type="checkbox"/>	
			49. TOTAL AMOUNT PROPERTY RECOVERED \$ _____

50. IS REPORT CONTINUED? YES NO 51. CAUTION INDICATORS, ATLS ETC.

52. DATA PROCESS INFORMATION:

COMPUTER ENTERED DATE 7.8.99

MICROFILM INDEXED INITIAL AS

IS CASE CLASSIFICATION CORRECT? N

IF N HAS CORRECTION BEEN MADE? N

53. FILE APPROVAL

BY [Signature] DATE 7.8.99

1. CASE # S99 No 04931 | 2. CLASSIFICATION 631911 | 3. CENSUS 141011

4. INCIDENT CS/S99-00242

5. INCIDENT LOCATION

6. NAME - LAST-FIRST-MI ANDREW (2) | 7. D.O.B.

8. ADDRESS | 9. TX-HOME

11. CITY STATE ZIP | 10. TX-BUSINESS

12. DETAILS OFC REQUESTS INCIDENT

06-25-99 1460

REC'D 14. 15. 16. 17.
DISP 10-23 10-24
13. DAY
SUN 1 THU 5
MON 2 FRI 6
TUE 3 SAT 7
WED 4

MANITOWOC COUNTY SHERIFF INCIDENT CARD

18. ASSIGNED COLBORN 41312
MISO 929

19. REC. BY 939 | 20. DIS. BY 939

22. TYPE OF REPORT
1. INCIDENT
2. ACCIDENT
3. CITATION
4. NONE

21. HOW REC'D.
1. 911
2. POLICE RADIO
3. PHONE
4. TTY
5. IN PERSON
6. ON VIEW
7. OFF. OFF DUTY
8. C.B. RADIO
9. OTHER

23. STATUS
1. UNFOUNDED
2. PNL
3. OTHER
4. CLEARED
5. EXCEPT CLEARED

24. DATE CLEARED 06/29/99

25. OFFENSE TYPE
1. ADULT NA
2. JUVENILE
3. UNKNOWN

39. (CODE S-SUSPECT W-WITNESS V-VICTIM O-OTHER)						
CODE	40. NAME-LAST	FIRST	MI	41. D.O.B.	42. ADDRESS	43. TELEPHONE
0	[REDACTED]	[REDACTED]	[REDACTED]	[REDACTED]	[REDACTED]	[REDACTED]
0	NELSON	DANIEL	A	[REDACTED]	[REDACTED] S Chestnut Ave, Grn Bay 54303	[REDACTED]

06/25/99: I, Deputy A. Colborn, received a telephone contact from MTPD Officer Jeff Seidl who informed me that he had contact with [REDACTED]. Officer Seidl informed me [REDACTED] told him that he observed a vehicle possibly matching the description of the suspect vehicle for incident S99-00242. Apparently, this vehicle bore WI handicap RP BS71 and was parked in the 300 block of Chestnut St in the City of Green Bay.

I then contacted [REDACTED] at his place of employment. [REDACTED] stated he realized this "was a very long shot." [REDACTED] stated he has observed the owner of the vehicle hand painting this vehicle several times. [REDACTED] stated he finds the activity somewhat suspicious and further stated the vehicle is from the type/year we are looking for.

I observed disabled RP BS71 was assigned to a 1986 Chevy truck. [REDACTED] described the vehicle as a full-sized Chevy van.

A teletype was sent to GBPD requesting their assistance in checking this vehicle. GBPD checked the vehicle and found no front end damage. GBPD further stated they believed the vehicle was originally silver in color, then red, and now hand painted black. They also determined the owner of the van was DANIEL NELSON. NELSON informed GBPD he purchased the vehicle in March from an electrical contractor located on Clay St in the City of Green Bay.

At this time, it does not appear this vehicle is the suspect vehicle for incident S99-00242. Again, GBPD was unable to locate any sort of front end damage on the vehicle.

No further action taken at this time, pending new leads reference this incident. This incident should be forwarded to Lt. M. Bushman for his review upon completion of typing.

ALColborn
a & c /bjc
[Handwritten initials]

S99 No 04931

45. IF COMPLAINANT DIFFERENT THEN CALLER, ENTER NAME, ADDRESS, D.O.B., TELEPHONE.

46. IF CODE O (OTHER) IS USED IN FIELD #39, EXPLAIN.

INCIDENT REPORT: NOTE: IF SECTION 22 ABOVE HAS NUMBER 4 CHECKED, DO NOT GO BEYOND THIS LINE WITHOUT RECORDS SECTION BEING ADVISED, OR NO RECORD ENTRIES WILL BE MADE BELOW THIS LINE.

PROPERTY VALUE	26. PROPERTY	A. CURRENCY	B. JEWELRY	C. FURS CLOTHING	D. VEHICLE (LOCAL)	E. OFFICE EQUIPMENT	F. RADIO, TV CAMERAS	G. FIREARMS	H. HOUSE-HOLD GOODS
	STOLEN	\$	\$	\$	\$	\$	\$	\$	\$
	RECOVERED	\$	\$	\$	\$	\$	\$	\$	\$
	26. PROPERTY	I. CONSUMABLES	J. LIVESTOCK	K. DRUGS	L. MARINE ITEMS	M. CONSTRUCTION ITEMS	N. LAWN AND GARDEN	O. SPORTING GOODS	P. MISC BICYCLE
	STOLEN	\$	\$	\$	\$	\$	\$	\$	\$
	RECOVERED	\$	\$	\$	\$	\$	\$	\$	\$

27. PROPERTY RECOVERED: LOCALLY _____ OTHER JURISDICTION _____ (INSERT O OR L)

PROPERTY ITEMIZATION	PROPERTY STOLEN/RECOVERED ITEMIZATION, USE THE FOLLOWING FORMAT				
	28. QUANTITY	29. ARTICLE NAME	30. BRAND NAME	31. SERIAL NUMBER	32. CODE
					S R <input type="checkbox"/> <input type="checkbox"/>
					S R <input type="checkbox"/> <input type="checkbox"/>
					S R <input type="checkbox"/> <input type="checkbox"/>
					S R <input type="checkbox"/> <input type="checkbox"/>

33. PROPERTY DAMAGE AMOUNT \$ _____

34. INSURANCE COMPANY _____

35. OFFICER ASSAULTED Y N

36. ARSON Y N

37. STRUCTURE CODE _____

38. DAMAGE \$ _____

47. CIB

ENTERED

CANCELLED

NCIC

OTHER BROADCAST

48. TOTAL AMOUNT PROPERTY STOLEN \$ _____

49. TOTAL AMOUNT PROPERTY RECOVERED \$ _____

50. IS REPORT CONTINUED? YES NO

51. CAUTION INDICATORS, ATLS ETC.

52. DATA PROCESS INFORMATION:

COMPUTER ENTERED DATE 7.6.99

MICROFILM INDEXED INITIAL AS

IS CASE CLASSIFICATION CORRECT?
IF N HAS CORRECTION BEEN MADE?

Y N

53. FILE APPROVAL

BY [Signature]

DATE 10/29/99

1. CASE # S99 No 04332 2. CLASSIFICATION 6.310.11 3. CENSUS 601000

4. INCIDENT CS/S99-0242

5. INCIDENT LOCATION

6. NAME - LAST - FIRST - MI MTSO 7. D.O.B.

8. ADDRESS 9. TX-HOME

11. CITY STATE ZIP 10. TX-BUSINESS

12. DETAILS
 A note was left in Lt. Bushman's squad room drawer that Mrs. Wetenkamp had phoned DI Tisler stating she may have more information as to possible suspect in her son's death. A request was made to make contact.

June 5/99 2300

14. RECD	15. DISP	16. 10-23	17. 10-24
13. DAY			
SUN 1	THU 5		
MON 2	FRI 6		
TUE 3	SAT 7		
WED 4			

MANITOWOC COUNTY SHERIFF INCIDENT CARD

18. ASSIGNED Lt. Bushman 2441

19. REC. BY 929 20. DIS. BY

21. HOW REC'D.
 1. 911
 2. POLICE RADIO
 3. PHONE
 4. TTY
 5. IN PERSON
 6. ON VIEW
 7. OFF. OFF DUTY
 8. C.B. RADIO
 9. OTHER

22. TYPE OF REPORT
 1. INCIDENT
 2. ACCIDENT
 3. CITATION
 4. NONE

23. STATUS
 1. UNFOUNDED
 2. PNL
 3. OTHER
 4. CLEARED
 5. EXCEPT CLEARED

24. DATE CLEARED 10-10-99

25. OFFENSE TYPE
 1. ADULT NA
 2. JUVENILE
 3. UNKNOWN

JUVENILE INFO REDACTED

39. (CODE S-SUSPECT W-WITNESS V-VICTIM O-OTHER)	40. NAME - LAST	FIRST	MI	41. D.O.B.	42. ADDRESS	43. TELEPHONE
W	[REDACTED]	[REDACTED]	[REDACTED]	[REDACTED]	[REDACTED]	[REDACTED]
O	Wetenkamp, Debra E.	[REDACTED]	[REDACTED]	[REDACTED]	4024 CTH CR, Mtwc	[REDACTED]
O	[REDACTED]	[REDACTED]	L	[REDACTED]	[REDACTED]	[REDACTED]
W	KIEL	[REDACTED]	WILLIAM	J	[REDACTED] S 23rd St, Manitowoc	[REDACTED]

06/02/99 2206hrs Atmpted contact, all dark.
 06/03/99 2130hrs Contact made with a daughter at the residence as Debra Wetenkamp was asleep. She stated "I know what this is about, my mom told me, just a minute I'll get you a name and number." The name [REDACTED] and a phone number [REDACTED] provided.
 2145hrs Contact made with [REDACTED] by phone. She did not wish to meet with officer this evening and requested an interview 06/04/99 between 0800hrs and 0900hrs at Lincoln High School. She did not wish to speak with Off. Trilling the liason officer as she has had conflicts with him in the past.
 [REDACTED] stated she felt Hockstettler's death was not an accident, she had no solid information but several names, one in particular who may be covering up for someone who would do harm to them if they found out Police were contacted. I asked if a uniform officer coming to see her at school was wise, as I was not far away. She wants someone to stop at school and she stated she was not in danger. M.J. Bushman

06/04/99 @ 0820 Hrs.: I, Deputy E. Glaeser, did make contact with [REDACTED] at Lincoln High School reference this complaint. [REDACTED] told me that she had been speaking with her boyfriend, [REDACTED], about this incident and apparently [REDACTED] had received information in regards to a possible suspect in this 10-50. According to [REDACTED] she admitted to Pastor Rose and I that most of the information that she has was speculation and hearsay but she believed that her boyfriend [REDACTED] connection had more reliable information.

06/04/99 @ 0840 Hrs.: I, Deputy E. Glaeser, did interview [REDACTED] boyfriend [REDACTED] at Lincoln High School. [REDACTED] told me that in the course of the past couple of weeks he did have occasion to meet an individual who goes by the name of "C. C." According to [REDACTED] this "C. C." guy is an individual who hangs out at the Golden Flame in the City of Manitowoc. [REDACTED] said that "C. C." has come up with a theory that could possibly indicate that RICHARD HOCHSTETTLER'S death was not an accident. [REDACTED] said that "C. C." believes that an individual by the name of [REDACTED] could possibly be the individual who struck HOCHSTETTLER. According to [REDACTED], the story is that [REDACTED] and HOCHSTETTLER were at the same party and shortly after HOCHSTETTLER left [REDACTED] also left and returned back at the party after approximately 1.5 hours.

S99 No 04332

45. IF COMPLAINANT DIFFERENT THEN CALLER, ENTER NAME, ADDRESS, D.O.B., TELEPHONE.

46. IF CODE O (OTHER) IS USED IN FIELD #39, EXPLAIN.

INCIDENT REPORT: NOTE: IF SECTION 22 ABOVE HAS NUMBER 4 CHECKED, DO NOT GO BEYOND THIS LINE WITHOUT RECORDS SECTION BEING ADVISED, OR NO RECORD ENTRIES WILL BE MADE BELOW THIS LINE.

PROPERTY VALUE	26. PROPERTY	A. CURRENCY	B. JEWELRY	C. FURS CLOTHING	D. VEHICLE (LOCAL)	E. OFFICE EQUIPMENT	F. RADIO, TV CAMERAS	G. FIREARMS	H. HOUSE-HOLD GOODS
	STOLEN	\$	\$	\$	\$	\$	\$	\$	\$
	RECOVERED	\$	\$	\$	\$	\$	\$	\$	\$
	26. PROPERTY	I. CONSUM-ABLES	J. LIVESTOCK	K. DRUGS	L. MARINE ITEMS	M. CONSTRUCTION ITEMS	N. LAWN AND GARDEN	O. SPORTING GOODS	P. MISC BICYCLE
	STOLEN	\$	\$	\$	\$	\$	\$	\$	\$
	RECOVERED	\$	\$	\$	\$	\$	\$	\$	\$

27. PROPERTY RECOVERED: LOCALLY _____ OTHER JURISDICTION _____ (INSERT O OR L)

PROPERTY ITEMIZATION	PROPERTY STOLEN/RECOVERED ITEMIZATION, USE THE FOLLOWING FORMAT				
	28. QUANTITY	29. ARTICLE NAME	30. BRAND NAME	31. SERIAL NUMBER	32. CODE
					S R <input type="checkbox"/> <input type="checkbox"/>
					S R <input type="checkbox"/> <input type="checkbox"/>
					S R <input type="checkbox"/> <input type="checkbox"/>
					S R <input type="checkbox"/> <input type="checkbox"/>
					S R <input type="checkbox"/> <input type="checkbox"/>

33. PROPERTY DAMAGE AMOUNT \$ _____

34. INSURANCE COMPANY _____

35. OFFICER ASSAULTED Y N

36. ARSON Y N

37. STRUCTURE CODE _____

38. DAMAGE \$ _____

47. CIB ENTERED CANCELLED
 NCIC
 OTHER BROADCAST

48. TOTAL AMOUNT PROPERTY STOLEN \$ _____

49. TOTAL AMOUNT PROPERTY RECOVERED \$ _____

50. IS REPORT CONTINUED? YES NO

51. CAUTION INDICATORS, ATLS ETC.

52. DATA PROCESS INFORMATION:

COMPUTER ENTERED DATE 16/09/99
 MICROFILM INDEXED INITIAL RS

53. FILE APPROVAL

IS CASE CLASSIFICATION CORRECT? Y N
 IF N HAS CORRECTION BEEN MADE? Y N

BY [Signature] DATE 16/10/99

MANITOWOC COUNTY SHERIFF'S DEPARTMENT
FOLLOW-UP REPORT

Page: 2

CASE NUMBER: 599-04332 CLASSIFICATION: _____

INCIDENT: _____

DATE AND TIME: _____

JUVENILE INFO REDACTED

REPORT CONTINUED:

According to this information it would be advisable for officers to try and contact "C. C." According to [REDACTED] "C. C." has tried several times to relay his information to MTPD but they will not take his information and "C. C." believes that possibly MTPD is involved.

[REDACTED] was unable to provide a name on this party who's nickname is "C. C." He described him as a taller individual (over 6' tall), with long black hair that he wears over his ears. Physically "C. C." is described as a thin, white Caucasian, and he does have a moustache. This individual drinks a lot of coffee and Mountain Dew in the late evening/early morning hours at the Golden Flame restaurant in Manitowoc. According to [REDACTED] "C. C." spends a lot of time at the Golden Flame, especially on the weekends in the evenings. It is suggested that a check be made with the evening MTPD or a check at the Golden Flame restaurant for this individual and interview him in regards to any information he may have on this case.

This report is being typed priority so that the information can be relayed to Lt. Bushman on 06/05/99. End of report at this time, pending further follow up. EJGlaeser *EST*/eco

It should be noted that left out from info. from my contact with [REDACTED], and [REDACTED] that both of those parties do wish to remain anonymous, and their identities should not be made known to the suspect, C.C., or anyone that he is associated with. This info. was relayed to Lt. Bushman, but should be noted on the incident report.

EJGlaeser /jml

Several checks were made with MTPD Patrol and Detective Divisions. No one seems to know a party nicknamed "CC" with the similar description above. Contact was made at the GOLDEN FLAME with several waitresses. It was learned "CC" would be WILLIAM KIEL. The in-house computer was used to obtain 10-27 information and an address.

All was dark at WILLIAM'S residence. Two 10-28s were confirmed that WILLIAM does live at this address. Both 10-28s came back to BARBARA L. KIEL.

07/02/99: Contact was made at [REDACTED] S 23rd St, Manitowoc, with BARBARA KIEL. She stated WILLIAM was her son and was not home at this time; however, she stated she could call him on his cell phone. Arrangements were made over the cell phone by BARBARA to have WILLIAM respond to the residence.

07/02/99 @ 2230 Hrs.: Contact was made with WILLIAM KIEL. At his request, we talked in Squad 61. A copy of this complaint with all the names blacked out was used to reference questions. WILLIAM stated he knew RICK HOCHSTETLER, having met him in 2-East. WILLIAM stated he was doing his own investigation because he has a theory. He recently went to the accident scene (but did not know where it was) noting skid marks which he feels could only have been made by a high 4-wheel drive type of vehicle. He suspects JOE MENA was maybe involved because he disliked HOCHSTETLER and he owned a Ford Bronco which was in an accident.

After I allowed WILLIAM to talk for quite some time, it became very obvious he did not know any details of the incident. The make and type of vehicle officers were looking for the

MANITOWOC COUNTY SHERIFF'S DEPARTMENT
FOLLOW-UP REPORT

Page: 3

CASE NUMBER: 599-04332 CLASSIFICATION: _____

INCIDENT: _____

DATE AND TIME: _____

REPORT CONTINUED:

height from the ground making it in all probability a standard pickup or van, no skid marks at the scene the night of the accident were some of the information that was passed along to WILLIAM. WILLIAM admitted he did not have any concrete information, only several theories about how the accident took place and who may have been involved. WILLIAM was thanked for his interest in the incident. He agreed to keep his ears open for any leads as he stated he finds out more street information than police can.

At this time, this particular complaint can be closed out until further information is received which may have some more concrete evidence. MJBushman /bjc



Manitowoc County Sheriff's Department

Thomas H. Kocourek
SHERIFF



Kenneth J. Petersen
INSPECTOR

6/2/99

Mike,

Got a call from Deb Wetenkamp asking if contact was made with [REDACTED]

[REDACTED] and some one with the last name Hintz. The Packer Inn was mentioned as a possible site that the driver may have come from

I'd give her a call for specific info

JUVENILE INFO REDACTED

6/3/99 CHECK OF P.E.I. 2506 HILL AVE BANK

JODI

1. CASE # **S99 No 04333** | 2. CLASSIFICATION **6.310.11** | 3. CENSUS **60000**

4. INCIDENT **CS/S99-0242**

5. INCIDENT LOCATION

6. NAME - LAST-FIRST-MI **M.TSO ANON** | 7. D.O.B.

8. ADDRESS | 9. TX-HOME

11. CITY STATE ZIP | 10. TX-BUSINESS

12. DETAILS
 On days off, I, Lt. Bushman received information that a Paul Virnoche living on the North side of Pigeon Lake had a Chev suburban late 80's that has not been seen since the Hochstettler fatal. Vehicle did have high miles and may have been retired naturally, but it did seem suspicious to the caller.

June 3/99 2300
 REC'D 14. DIS 15. 10-23 16. 10-24 17.
 13. DAY
 SUN 1 THU 5
 MON 2 FRI 6
 TUE 3 SAT 7
 WED 4

MANITOWOC COUNTY SHERIFF INCIDENT CARD

18. ASSIGNED
Lt. Bushman | **AAI**

19. REC. BY **929** | 20. DIS. BY

21. HOW REC'D.
 1. 911
 2. POLICE RADIO
 3. PHONE
 4. TTY
 5. IN PERSON
 6. ON VIEW
 7. OFF. OFF DUTY
 8. C.B. RADIO
 9. OTHER
 21A. M.O.

22. TYPE OF REPORT
 1. INCIDENT
 2. ACCIDENT
 3. CITATION
 4. NONE

23. STATUS
 1. UNFOUNDED
 2. PNL
 3. OTHER
 4. CLEARED
 5. EXCEPT CLEARED

24. DATE CLEARED **06/07/99**

25. OFFENSE TYPE
 1. ADULT NA
 2. JUVENILE
 3. UNKNOWN

ACTIVE

39. (CODE S-SUSPECT W-WITNESS V-VICTIM O-OTHER)	40. NAME-LAST	FIRST	MI	41. D.O.B.	42. ADDRESS	43. TELEPHONE
0	Virnoche Paul R.	1593			Pigeon Lk. Rd. Valders	
0	KING	19216	MICHAEL	B	Marvelle Ln, Green Bay	

06/04/99 2200hrs Contact made with a Pigeon Lake resident who looked up Virnoche in the Pigeon Lk. Assoc. register. The above address located. MTSO inhouse has █████ Lakeshore, Newton.

Also a RHAS check was run and Viroche does have 4 vehicles registered to him, one is an 88 Chevrolet truck.
 2255hrs A walk to the residence was made as there were lights visible from the road. Numerous lights on, no answer at the door. M.J. Bushman

06/04/99 @ 0630 Hrs.: I, Deputy E. Glaeser, spoke to PAUL VIRNOCHE at his residence on Pigeon Lake. VIRNOCHE was asked if he was still in possession of a 1988 Chevy truck to which he did respond that the vehicle would more specifically be a Suburban and that a friend of his, MICHAEL KING, presently has possession of the vehicle with VIRNOCHE'S permission.

I explained to VIRNOCHE that the vehicle meets the parameters of our hit-and-run suspect vehicle and at this time we were attempting to eliminate any possible vehicles from our suspect list. VIRNOCHE explained to me that he borrowed the vehicle to KING in September of 1998 as KING was in a position where he needed a vehicle. VIRNOCHE told me that the vehicle has not been in Manitowoc County since that time. VIRNOCHE said that KING is a friend of VIRNOCHE'S son and he voluntarily helps the boy out and provided a vehicle for him.

In regards to any damage on the vehicle, VIRNOCHE did claim that the right front grill area is cracked and has minor damage but he explained that it was from an accident that happened 3-4 years ago in the City of Sheboygan at 14th St and Erie St. He did claim that this was a winter accident, it was snow related, and a report was filled out by SBSO.

VIRNOCHE did describe the vehicle as a dark blue 1988 Chevy Suburban and he provided a RP of EUB534. VIRNOCHE also provided information on KING with an address on Marvelle Ln and a telephone number in Green Bay. An attempt will be made to contact KING to verify that information.

S99 No 04333

45. IF COMPLAINANT DIFFERENT THEN CALLER, ENTER NAME, ADDRESS, D.O.B., TELEPHONE.

46. IF CODE O (OTHER) IS USED IN FIELD #39, EXPLAIN.

INCIDENT REPORT: NOTE: IF SECTION 22 ABOVE HAS NUMBER 4 CHECKED, DO NOT GO BEYOND THIS LINE WITHOUT RECORDS SECTION BEING ADVISED, OR NO RECORD ENTRIES WILL BE MADE BELOW THIS LINE.

PROPERTY VALUE	26. PROPERTY	A. CURRENCY	B. JEWELRY	C. FURS CLOTHING	D. VEHICLE (LOCAL)	E. OFFICE EQUIPMENT	F. RADIO, TV CAMERAS	G. FIREARMS	H. HOUSE-HOLD GOODS
	STOLEN	\$	\$	\$	\$	\$	\$	\$	\$
	RECOVERED	\$	\$	\$	\$	\$	\$	\$	\$
	26. PROPERTY	I. CONSUM-ABLES	J. LIVESTOCK	K. DRUGS	L. MARINE ITEMS	M. CONSTRUCTION ITEMS	N. LAWN AND GARDEN	O. SPORTING GOODS	P. MISC BICYCLE
	STOLEN	\$	\$	\$	\$	\$	\$	\$	\$
	RECOVERED	\$	\$	\$	\$	\$	\$	\$	\$

27. PROPERTY RECOVERED: LOCALLY _____ OTHER JURISDICTION _____ (INSERT O OR L)

PROPERTY ITEMIZATION	PROPERTY STOLEN/RECOVERED ITEMIZATION, USE THE FOLLOWING FORMAT				
	28. QUANTITY	29. ARTICLE NAME	30. BRAND NAME	31. SERIAL NUMBER	
					S <input type="checkbox"/> R <input type="checkbox"/>
					S <input type="checkbox"/> R <input type="checkbox"/>
					S <input type="checkbox"/> R <input type="checkbox"/>
					S <input type="checkbox"/> R <input type="checkbox"/>
					S <input type="checkbox"/> R <input type="checkbox"/>

33. PROPERTY DAMAGE AMOUNT \$ _____

34. INSURANCE COMPANY _____

35. OFFICER ASSAULTED Y N

36. ARSON Y N

37. STRUCTURE CODE _____

38. DAMAGE \$ _____

47. CIB ENTERED CANCELLED
 NCIC
 OTHER BROADCAST

48. TOTAL AMOUNT PROPERTY STOLEN \$ _____

49. TOTAL AMOUNT PROPERTY RECOVERED \$ _____

50. IS REPORT CONTINUED? YES NO

51. CAUTION INDICATORS, ATLS ETC.

52. DATA PROCESS INFORMATION:

COMPUTER ENTERED DATE 6/29/99
 MICROFILM INDEXED INITIAL RS

IS CASE CLASSIFICATION CORRECT?
 IF N HAS CORRECTION BEEN MADE? Y N

53. FILE APPROVAL

BY [Signature] DATE 6/10/99

MANITOWOC COUNTY SHERIFF'S DEPARTMENT
FOLLOW-UP REPORT

Page: 2

CASE NUMBER: S99-04333 CLASSIFICATION: _____

INCIDENT: _____

DATE AND TIME: _____

REPORT CONTINUED:

06/04/99 @ 1030 Hrs.: I, Deputy E. Glaeser, did speak to MICHAEL KING reference this incident. KING relayed to me the same information that I had received from VIRNOCHE. He also told me that VIRNOCHE is the father of one of his good friends and VIRNOCHE did allow him to drive the 1988 Chevy Suburban free of charge. He further stated that VIRNOCHE runs the registration and also covers the insurance on the vehicle. I asked KING why VIRNOCHE is so nice to him and he stated that ever since his dad died VIRNOCHE has treated him like he was his 8th son.

In regards to any damage on the vehicle, KING told me that the grill was cracked a small amount on the right side and he told me that he could easily make the vehicle available so that it could be viewed at any time on today's date. I explained to KING that I would attempt to contact BRSO to see if they had an officer available to do just that.

KING was asked if he could come up with the RP and VIN for the truck so that I could check it against the records that were run on VIRNOCHE. Approximately 1 hour later KING did contact me with the same information; RP of EUB534 and the same VIN number as the information run off of VIRNOCHE'S truck.

06/04/99 @ 1220 Hrs.: I, Deputy E. Glaeser, did make contact with the ASPD (Village of Ashwaubenon PD) and did speak to a Dispatcher reference this incident. A Dispatcher by the name of Cindy was requested to send an officer to check damage to VIRNOCHE'S Suburban at ██████ Marvelle Ln in Green Bay. The Dispatcher there told me that they would assign this to an officer and report back to me with the results of the extent of the damage to the vehicle. Cindy was asked to leave a message in regards to the damage for me so that a determination could be made at that time on whether or not we would need to send an officer to check the vehicle in person. EJGlaeser *ETC* /eco

06/04/99 @ 1245 Hrs.: I, Deputy E. Glaeser, was contacted by the ASPD and they did connect me with Officer Steven Pelch, #689, who was presently viewing the suspect vehicle. Officer Pelch told me that according to the description I had given him, this vehicle would not match our suspect vehicle. The vehicle was described by Officer Pelch as having right front damage to the grill area with the area of damage being approximately 1' long and 1" wide. This would make the damage inconsistent with the amount of evidence located at our accident scene. Officer Pelch also told me that the front bumper was pushed in on the truck but he did not note any damage to the radiator nor was there damage to any of the fan blades on the inside of the radiator. Due to this information being inconsistent with our hit-and-run vehicle, this vehicle can be eliminated as a suspect in this case. No further action needed. EJGlaeser *ETC* /eco

[Handwritten signature]

1. CASE # S99 No 04617
 2. CLASSIFICATION 6.310.11
 3. CENSUS 5.2.000

4. INCIDENT CS / S99-00242
 5. INCIDENT LOCATION SHEBOYGAN CO. JAIL
 6. NAME - LAST - FIRST - MI
 7. D.O.B.
 8. ADDRESS
 9. TX-HOME
 11. CITY STATE ZIP
 10. TX-BUSINESS

12. DETAILS
 INMATE CLAIMS TO KNOW WHERE
 SUSPECT HIT & RUN VAN IS LOCATED
 IN MILWAUKEE

JUVENILE INFO REDACTED

2121
 66 07 99
 06 07 99
 SUN 1 THU 5
 MON 2 FRI 6
 TUE 3 SAT 7
 WED 4

MANITOWOC COUNTY SHERIFF
 INCIDENT CARD

18. ASSIGNED
 BUSHMAN 4411
 JOST 4419

19. REC. BY 436
 20. DIS. BY 436

21. HOW REC'D.
 1. 911
 2. POLICE RADIO
 3. PHONE
 4. TTY
 5. IN PERSON
 6. ON VIEW
 7. OFF. OFF DUTY
 8. C.B. RADIO
 9. OTHER

22. TYPE OF REPORT
 1. INCIDENT
 2. ACCIDENT
 3. CITATION
 4. NONE

23. STATUS
 1. UNFOUNDED
 2. PNL
 3. OTHER
 4. CLEARED
 5. EXCEPT CLEARED

24. DATE CLEARED 10/11/99

25. OFFENSE TYPE
 1. ADULT NA
 2. JUVENILE
 3. UNKNOWN

39. (CODE S-SUSPECT W-WITNESS V-VICTIM O-OTHER)	40. NAME-LAST	FIRST	MI	41. D.O.B.	42. ADDRESS	43. TELEPHONE
0	[REDACTED]	[REDACTED]	178590	[REDACTED]	[REDACTED]	[REDACTED]
0	[REDACTED]	[REDACTED]	176403	[REDACTED]	[REDACTED]	[REDACTED]
0	[REDACTED]	[REDACTED]	118948	[REDACTED]	[REDACTED]	[REDACTED]
0	[REDACTED]	[REDACTED]	178591	[REDACTED]	[REDACTED]	[REDACTED]

06/07/99 @ 1530 hrs.: I, Lt. Bushman, received a phone call at home from Lt. Thorrington ref. a Sheboygan Co. inmate who apparently made statements to a detective telling him that he knows where the van is, it was stolen, who stole it, and who was driving, referring to the CrimeStoppers poster in the Sheboygan Co. Sheriff's Office ref. the Hochstetler Hit-and-Run accident.

Officer Jost picked up the S99-00242 Report Box and then me, Lt. Bushman, at my residence. Contact was made with Sheboygan Co. Juvenile Facility, and Officers requested to have interview with [REDACTED] ref. his statements he made to a detective while in custody in Sheboygan. The files on [REDACTED] were read prior to conducting the interview. As the interview began, it became apparent that [REDACTED] knew nothing of the Hit-and-Run accident. He had seen the poster and read the words van, Manitowoc Co., and \$25,000. [REDACTED] stated, "I'm looking into getting that \$25,000." He then talked about a brand new van stolen in Manitowoc, and that [REDACTED] was the thief. At least 8 vehicles, a Lexus, a Chevrolet van, and other models all 1999's were stolen by [REDACTED]. Not all were taken from Manitowoc, but definitely the van. [REDACTED] stated in his words, "The van was all decked out, loaded, leather, and it was white in color." It currently is in the city of Milwaukee being driven by a black man, whose nickname is JJ. The theft took place at least 6 weeks ago. There was nothing mentioned of any damage from an accident on the van. [REDACTED] stated [REDACTED] wouldn't talk to any police, but will talk to him. The problem is they are in separate cell blocks. [REDACTED] states the evening before, the 2 cell blocks were open, and he needs them both open so he can talk to [REDACTED] for more details. He states he will write down any of the details after he leaves the conversation, so he doesn't forget them.

The jailer advised that was possible to open the two blocks for recreational period, and he would do so hoping more info. would be forthcoming ref. the stolen vehicles. Any further info. would be passed on to the city of Manitowoc, as that is where the van was taken from the Petroski Lot.

The day after the interview, info. was passed on to Det. Bergner by Officer Jost. Det. Bergner stated that [REDACTED] has already been charged with [REDACTED]

S99 No 04617

45. IF COMPLAINANT DIFFERENT THEN CALLER, ENTER NAME, ADDRESS, D.O.B., TELEPHONE.

46. IF CODE O (OTHER) IS USED IN FIELD #39, EXPLAIN.

INCIDENT REPORT: NOTE: IF SECTION 22 ABOVE HAS NUMBER 4 CHECKED, DO NOT GO BEYOND THIS LINE WITHOUT RECORDS SECTION BEING ADVISED, OR NO RECORD ENTRIES WILL BE MADE BELOW THIS LINE.

P R O P E R T Y V A L U E	26. PROPERTY	A. CURRENCY	B. JEWELRY	C. FURS CLOTHING	D. VEHICLE (LOCAL)	E. OFFICE EQUIPMENT	F. RADIO, TV CAMERAS	G. FIREARMS	H. HOUSE-HOLD GOODS
	STOLEN	\$	\$	\$	\$	\$	\$	\$	\$
	RECOVERED	\$	\$	\$	\$	\$	\$	\$	\$
	26. PROPERTY	I. CONSUMABLES	J. LIVESTOCK	K. DRUGS	L. MARINE ITEMS	M. CONSTRUCTION ITEMS	N. LAWN AND GARDEN	O. SPORTING GOODS	P. MISC BICYCLE
STOLEN	\$	\$	\$	\$	\$	\$	\$	\$	
RECOVERED	\$	\$	\$	\$	\$	\$	\$	\$	

27. PROPERTY RECOVERED: LOCALLY _____ OTHER JURISDICTION _____ (INSERT O OR L)

P R O P E R T Y I T E M I Z A T I O N	PROPERTY STOLEN/RECOVERED ITEMIZATION, USE THE FOLLOWING FORMAT				
	28. QUANTITY	29. ARTICLE NAME	30. BRAND NAME	31. SERIAL NUMBER	32. CODE
					S R <input type="checkbox"/> <input type="checkbox"/>
					S R <input type="checkbox"/> <input type="checkbox"/>
					S R <input type="checkbox"/> <input type="checkbox"/>
					S R <input type="checkbox"/> <input type="checkbox"/>

33. PROPERTY DAMAGE AMOUNT \$ _____

34. INSURANCE COMPANY _____

35. OFFICER ASSAULTED Y N

36. ARSON Y N

37. STRUCTURE CODE _____

38. DAMAGE \$ _____

47. CIB ENTERED CANCELLED
 NCIC
 OTHER BROADCAST

48. TOTAL AMOUNT PROPERTY STOLEN \$ _____

49. TOTAL AMOUNT PROPERTY RECOVERED \$ _____

50. IS REPORT CONTINUED? YES NO

51. CAUTION INDICATORS, ATLS ETC.

52. DATA PROCESS INFORMATION:

COMPUTER ENTERED DATE 6/24/99

MICROFILM INDEXED INITIAL DS

IS CASE CLASSIFICATION CORRECT? Y N
 IF N HAS CORRECTION BEEN MADE? Y N

53. FILE APPROVAL

BY [Signature] DATE 6/16/99

MANITOWOC COUNTY SHERIFF'S DEPARTMENT
FOLLOW-UP REPORT

Page: 2

CASE NUMBER: S99-04617 CLASSIFICATION: _____

INCIDENT: _____ JUVENILE INFO REDACTED

DATE AND TIME: _____

REPORT CONTINUED:

can be closed out, the individuals listed on the front, [REDACTED] and [REDACTED], would be the 2 suspects the city has already charged. No further follow-up. MBushman /jml

06/15/99: I, Det. Sgt. Lenk, of the MTSO was given info. to proceed to the Sheboygan Co. Jail to talk to a [REDACTED] in regard to possible info. on the Hit-and-Run accident that occurred on incident # S99-00242. Upon arriving at the Sheboygan Co. Jail, I learned that [REDACTED] is actually in the Juvenile Detention Area of the Sheboygan Co. Jail, and was given escort to that facility. I met with [REDACTED], who stated that he had received info. from one [REDACTED] while at the Juvenile Detention Center at Sheboygan Co. Sheriff's Dept.

[REDACTED] stated that [REDACTED] and a [REDACTED], were both involved in stealing vehicles from Manitowoc City. [REDACTED] has been bragging about stealing these vehicles while he was in lockup.

[REDACTED] stated that his cousin, [REDACTED], has gotten info. from [REDACTED], and that has been trying to get more info. regarding possible hit-and-run vehicle, but has been unable to get info.

[REDACTED] said that he had heard that a stolen van, maybe white in color, is still in Milwaukee, and is in the garage of one black male known as [REDACTED] (spelling unknown). This van was stolen by kids, and could possibly have been the hit-and-run vehicle that killed someone.

I asked [REDACTED] if he got his info. from [REDACTED], and he said that [REDACTED] only talked to him about stealing vehicles. [REDACTED] stated that this black male, known as [REDACTED], is supposed to be armed and dangerous, and may be into drugs. [REDACTED] stated that [REDACTED] has been at this black male's house in Milwaukee before.

[REDACTED] said that his cousin, [REDACTED], saw the reward poster and then put 2 and 2 together, and figured that [REDACTED] might be involved in the hit-and-run incident that occurred in Manitowoc. [REDACTED] said that he got the info. from [REDACTED] regarding the van also.

I also conducted interview with [REDACTED] while I was at the Sheboygan Co. Juvenile Detention Center. [REDACTED] was read his rights, and he signed them and stated he was willing to answer some questions.

[REDACTED] stated that he has no knowledge of any hit-and-run that occurred in Manitowoc Co., and doesn't know anything about a van or anything about a person being killed, only that he has seen it on the reward poster at the Sheriff's Dept. [REDACTED] stated that he has already been interviewed by 2 officers from Manitowoc regarding the vehicle thefts from Manitowoc. He stated he was visiting a girl in Manitowoc with [REDACTED], and they stayed in Manitowoc for 2 days and then went to see a friend in Milwaukee. [REDACTED] would not give any other info. regarding any of the thefts or any further info. on that hit-and-run.

MANITOWOC COUNTY SHERIFF'S DEPARTMENT
FOLLOW-UP REPORT

Page: 3

CASE NUMBER: S99-04617 CLASSIFICATION: _____

INCIDENT: _____

DATE AND TIME: _____

REPORT CONTINUED:

After interviewing both [REDACTED] and [REDACTED] it is my opinion that neither of these juveniles have any relevant info. regarding the hit-and-run accident that occurred on January 10, 1999 in Manitowoc Co. JLenk /jml

JUVENILE INFO REDACTED

Place SB50
Date 06-15-99
Time 1150

MIRANDA WARNING

YOU HAVE THE RIGHT TO REMAIN SILENT.
ANYTHING YOU SAY CAN AND WILL BE USED AGAINST YOU IN A COURT OF LAW.
YOU HAVE THE RIGHT TO CONSULT WITH A LAWYER BEFORE QUESTIONING AND TO HAVE
A LAWYER PRESENT WITH YOU DURING YOUR QUESTIONING.
IF YOU CANNOT AFFORD TO HIRE A LAWYER, ONE WILL BE APPOINTED TO REPRESENT
YOU AT PUBLIC EXPENSE BEFORE OR DURING ANY QUESTIONING, IF YOU SO WISH.
IF YOU DECIDE TO ANSWER QUESTIONS NOW WITHOUT A LAWYER PRESENT, YOU HAVE THE
RIGHT TO STOP THE QUESTIONING AND REMAIN SILENT AT ANY TIME YOU WISH, AND THE RIGHT
TO ASK FOR AND HAVE A LAWYER AT ANY TIME YOU WISH, INCLUDING DURING THE QUESTIONING.

Signed [Redacted Signature]

* * * * *

WAIVER

DO YOU UNDERSTAND EACH OF THESE RIGHTS?

REALIZING THAT YOU HAVE THESE RIGHTS, ARE YOU NOW WILLING TO ANSWER QUESTIONS
OR MAKE A STATEMENT?

Signed [Redacted Signature]

Witness Det. Sgt. James Mend

Witness _____

Date _____

JUVENILE INFO REDACTED

1. CASE # S99 No 05242
 2. CLASSIFICATION 631011
 3. CENSUS 5121000

4. INCIDENT 05/S99-00242
 5. INCIDENT LOCATION MTSO
 6. NAME- LAST-FIRST-MI ANONYMOUS (2) 7. D.O.B.
 8. ADDRESS 9. TX-HOME
 11. CITY STATE ZIP 10. TX-BUSINESS

12. DETAILS
 REPORTS WHITE SILVERADO
 MJX417 w/ FRONT END DAMAGE
 IN FLEET FARM PARKING LOT

07-05-99 M440

14. REC'D. 15. DISP. 16. 10-23 17. 10-24
 13. DAY
 SUN 1 THU 5
 MON 2 FRI 6
 TUE 3 SAT 7
 WED 4

MANITOWOC COUNTY SHERIFF
 INCIDENT CARD

18. ASSIGNED INFO 91811
 COLBORN 4312

19. REC. BY 939 20. DIS. BY 939
 21. HOW REC'D.
 1. 911
 2. POLICE RADIO
 3. PHONE
 4. TTY
 5. IN PERSON
 6. ON VIEW
 7. OFF. OFF DUTY
 8. C.B. RADIO
 9. OTHER
 21A. M.O.

22. TYPE OF REPORT
 1. INCIDENT
 2. ACCIDENT
 3. CITATION
 4. NONE
 23. STATUS
 1. UNFOUNDED
 2. PNL
 3. OTHER
 4. CLEARED
 5. EXCEPT CLEARED
 24. DATE CLEARED 10/08/99
 25. OFFENSE TYPE
 1. ADULT NA
 2. JUVENILE
 3. UNKNOWN

39. (CODE S-SUSPECT W-WITNESS V-VICTIM O-OTHER)						
CODE	40. NAME-LAST	FIRST	MI	41. D.O.B.	42. ADDRESS	43. TELEPHONE
O	DUELLMAN	ANDREW	T		N 6th St, Manitowoc	
O	DUELLMAN	JESS	E			
O	ANHALT	TREVOR	C		N 6th St, Manitowoc	

07/05/99: I, Deputy A. Colborn, was assigned this incident from MTSO Dispatch. Preliminary information received was that an anonymous caller called Dispatch and informed them they observed a white Chevrolet vehicle bearing WI RP MJX417 in the parking lot of FLEET FARM. Apparently, this vehicle had front end damage.

A check through WI DOT indicated the RP of MJX417 was assigned to JESS DUELLMAN. Contact was made at Easy St, Manitowoc. At this time, I was informed by JESS' parents that JESS does not reside at Easy St.

Telephone contact was made with JESS who informed me his brother, ANDREW DUELLMAN, was actually the owner of the vehicle. It was determined the vehicle was a Chevrolet Blazer.

I then responded to an area on S 15th St where I made contact with ANDREW. ANDREW informed me his vehicle has previously been checked by Officer Crabb of MTPD. ANDREW further stated he has just recently bought the vehicle from TREVOR ANHALT. ANDREW stated the vehicle had also been checked by MTPD when TREVOR owned the vehicle.

ANDREW still agreed to show me the vehicle which I observed to be totally missing its front grill; however, I did not observe any sheet metal damage to the hood. I did not observe any sheet metal damage to the front fenders. I further observed the bumper seemed to be free of any damage.

At this time, it does not appear this vehicle is the suspect vehicle for incident S99-00242. No further action taken at this time. A copy of this incident should be directed to incident commander, Lt. M. Bushman, upon completion of typing. MJBushman /bjc

CASE # S99 No 052

45. IF COMPLAINANT DIFFERENT THEN CALLER, ENTER NAME, ADDRESS, D.O.B., TELEPHONE.

46. IF CODE O (OTHER) IS USED IN FIELD #39, EXPLAIN.

INCIDENT REPORT: NOTE: IF SECTION 22 ABOVE HAS NUMBER 4 CHECKED, DO NOT GO BEYOND THIS LINE WITHOUT RECORDS SECTION BEING ADVISED, OR NO RECORD ENTRIES WILL BE MADE BELOW THIS LINE.

PROPERTY VALUE	26. PROPERTY	A. CURRENCY	B. JEWELRY	C. FURS CLOTHING	D. VEHICLE (LOCAL)	E. OFFICE EQUIPMENT	F. RADIO, TV CAMERAS	G. FIREARMS	H. HOUSE-HOLD GOODS
	STOLEN	\$	\$	\$	\$	\$	\$	\$	\$
	RECOVERED	\$	\$	\$	\$	\$	\$	\$	\$
	26. PROPERTY	I. CONSUMABLES	J. LIVESTOCK	K. DRUGS	L. MARINE ITEMS	M. CONSTRUCTION ITEMS	N. LAWN AND GARDEN	O. SPORTING GOODS	P. MISC BICYCLE
	STOLEN	\$	\$	\$	\$	\$	\$	\$	\$
	RECOVERED	\$	\$	\$	\$	\$	\$	\$	\$

27. PROPERTY RECOVERED: LOCALLY _____ OTHER JURISDICTION _____ (INSERT O OR L)

PROPERTY ITEMIZATION	PROPERTY STOLEN/RECOVERED ITEMIZATION, USE THE FOLLOWING FORMAT				
	28. QUANTITY	29. ARTICLE NAME	30. BRAND NAME	31. SERIAL NUMBER	32. CODE
					S <input type="checkbox"/> R <input type="checkbox"/>
					S <input type="checkbox"/> R <input type="checkbox"/>
					S <input type="checkbox"/> R <input type="checkbox"/>
					S <input type="checkbox"/> R <input type="checkbox"/>
					S <input type="checkbox"/> R <input type="checkbox"/>

33. PROPERTY DAMAGE AMOUNT \$ _____

34. INSURANCE COMPANY _____

35. OFFICER ASSAULTED Y N 36. ARSON Y N 37. STRUCTURE CODE _____ 38. DAMAGE \$ _____

47. CIB ENTERED CANCELLED
 NCIC
 OTHER BROADCAST

48. TOTAL AMOUNT PROPERTY STOLEN \$ _____

49. TOTAL AMOUNT PROPERTY RECOVERED \$ _____

50. IS REPORT CONTINUED? YES NO

51. CAUTION INDICATORS, ATLS ETC.

52. DATA PROCESS INFORMATION:

COMPUTER ENTERED DATE 1/18/99

MICROFILM INDEXED INITIAL AS

IS CASE CLASSIFICATION CORRECT? N
 IF N HAS CORRECTION BEEN MADE? N

53. FILE APPROVAL

BY KR DATE 070899

1. CASE # S99 No 05197 2. CLASSIFICATION 6301 3. CENSJS 52000

4. INCIDENT CS/599-00242

5. INCIDENT LOCATION

6. NAME - LAST - FIRST - MI Anonymous (2) 7 D.O.B.

8. ADDRESS 9. TX-HOME

11. CITY STATE ZIP 10. TX-BUSINESS

12. DETAILS See attached

REC'D 14. 15. 16. 17. 10-23 10-24
DISP
13. DAY
SUN 1 THU 5
MON 2 FRI 6
TUE 3 SAT 7
WED 4

MANITOWOC COUNTY SHERIFF INCIDENT CARD

18. ASSIGNED HPSO 9219

19. REC. BY. 935 20. DIS. BY.

21. HOW REC'D. 1. 911 2. POLICE RADIO 3. PHONE 4. TTY 5. IN PERSON 6. ON VIEW 7. OFF. OFF DUTY 8. C.B. RADIO 9. OTHER

22. TYPE OF REPORT 1. INCIDENT 2. ACCIDENT 3. CITATION 4. NONE 23. STATUS 1. UNFOUNDED 2. PNL 3. OTHER 4. CLEARED 5. EXCEPT CLEARED

24. DATE CLEARED 10/1/00

25. OFFENSE TYPE 1. ADULT 2. JUVENILE 3. UNKNOWN

Table with 4 columns: CODE, 40. NAME-LAST, FIRST, MI, 41. D.O.B., 42. ADDRESS, 43. TELEPHONE. Row 1: 39. (CODE S-SUSPECT W-WITNESS V-VICTIM O-OTHER)

S99 No 05197

45. IF COMPLAINANT DIFFERENT THEN CALLER, ENTER NAME, ADDRESS, D.O.B., TELEPHONE:

46. IF CODE O (OTHER) IS USED IN FIELD #39, EXPLAIN.

INCIDENT REPORT: NOTE: IF SECTION 22 ABOVE HAS NUMBER 4 CHECKED, DO NOT GO BEYOND THIS LINE WITHOUT RECORDS SECTION BEING ADVISED, OR NO RECORD ENTRIES WILL BE MADE BELOW THIS LINE.

PROPERTY VALUE	26. PROPERTY	A. CURRENCY	B. JEWELRY	C. FURS CLOTHING	D. VEHICLE (LOCAL)	E. OFFICE EQUIPMENT	F. RADIO, TV CAMERAS	G. FIREARMS	H. HOUSE-HOLD GOODS
	STOLEN	\$	\$	\$	\$	\$	\$	\$	\$
	RECOVERED	\$	\$	\$	\$	\$	\$	\$	\$
	26. PROPERTY	I. CONSUMABLES	J. LIVESTOCK	K. DRUGS	L. MARINE ITEMS	M. CONSTRUCTION ITEMS	N. LAWN AND GARDEN	O. SPORTING GOODS	P. MISC BICYCLE
	STOLEN	\$	\$	\$	\$	\$	\$	\$	\$
	RECOVERED	\$	\$	\$	\$	\$	\$	\$	\$

27. PROPERTY RECOVERED: LOCALLY ____ OTHER JURISDICTION ____ (INSERT O OR L)

PROPERTY ITEMIZATION	PROPERTY STOLEN/RECOVERED ITEMIZATION, USE THE FOLLOWING FORMAT			
	28. QUANTITY	29. ARTICLE NAME	30. BRAND NAME	31. SERIAL NUMBER

32. CODE
 S R
 S R
 S R
 S R
 S R
 S R

33. PROPERTY DAMAGE AMOUNT \$ _____ 34. INSURANCE COMPANY _____

35. OFFICER ASSAULTED Y N 36. ARSON Y N 37. STRUCTURE CODE _____ 38. DAMAGE \$ _____

47. CIB ENTERED CANCELLED
 NCIC
 OTHER BROADCAST

48. TOTAL AMOUNT PROPERTY STOLEN \$ _____
 49. TOTAL AMOUNT PROPERTY RECOVERED \$ _____

50. IS REPORT CONTINUED? YES NO 51. CAUTION INDICATORS, ATLS ETC.

52. DATA PROCESS INFORMATION:
 COMPUTER ENTERED DATE 5/17/08
 MICROFILM INDEXED INITIAL KS
 IS CASE CLASSIFICATION CORRECT? Y N
 IF N HAS CORRECTION BEEN MADE? Y N

53. FILE APPROVAL
 BY [Signature] DATE 05/16/08

1. CASE # S99 No 05579 | 2. CLASSIFICATION 6,310,1 | 3. CENSUS 1,410,0,2

4. INCIDENT CS/S99-00242

5. INCIDENT LOCATION

6. NAME - LAST - FIRST - MI ANDY. | 7. D.O.B.

8. ADDRESS | 9. TX-HOME

11. CITY STATE ZIP | 10. TX-BUSINESS

12. DETAILS SEE ATTACHED.

7-16-99 2102 65-91-6

MANITOWOC COUNTY SHERIFF
INCIDENT CARD

18. ASSIGNED MTSO 9/29

19. REC. BY 932 | 20. DIS. BY

21. HOW REC'D. 3 POLICE RADIO PHONE

22. TYPE OF REPORT 1 INCIDENT 2 ACCIDENT 3 CITATION 4 NONE

23. STATUS 1 UNFOUNDED 2 PNL 3 OTHER 4 CLEARED 5 EXCEPT CLEARED

14. REC'D. | 15. DISP | 16. 10-23 | 17. 10-24

13. DAY
SUN 1 THU 5
MON 2 FRI 6
TUE 3 SAT 7
WED 4

24. DATE CLEARED 10/16/99

25. OFFENSE TYPE
1. ADULT NA
2. JUVENILE
3. UNKNOWN

39. (CODE S-SUSPECT W-WITNESS V-VICTIM O-OTHER)				42. ADDRESS		43. TELEPHONE
CODE	40. NAME-LAST	FIRST	MI	41. D.O.B.		

45. IF COMPLAINANT DIFFERENT THEN CALLER, ENTER NAME, ADDRESS, D.O.B., TELEPHONE.

46. IF CODE O (OTHER) IS USED IN FIELD #39, EXPLAIN.

INCIDENT REPORT: NOTE: IF SECTION 22 ABOVE HAS NUMBER 4 CHECKED, DO NOT GO BEYOND THIS LINE WITHOUT RECORDS SECTION BEING ADVISED, OR NO RECORD ENTRIES WILL BE MADE BELOW THIS LINE.

PROPERTY VALUE	26. PROPERTY	A. CURRENCY	B. JEWELRY	C. FURS CLOTHING	D. VEHICLE (LOCAL)	E. OFFICE EQUIPMENT	F. RADIO, TV CAMERAS	G. FIREARMS	H. HOUSE-HOLD GOODS
	STOLEN	\$	\$	\$	\$	\$	\$	\$	\$
	RECOVERED	\$	\$	\$	\$	\$	\$	\$	\$
	26. PROPERTY	I. CONSUMABLES	J. LIVESTOCK	K. DRUGS	L. MARINE ITEMS	M. CONSTRUCTION ITEMS	N. LAWN AND GARDEN	O. SPORTING GOODS	P. MISC BICYCLE
	STOLEN	\$	\$	\$	\$	\$	\$	\$	\$
	RECOVERED	\$	\$	\$	\$	\$	\$	\$	\$

27. PROPERTY RECOVERED: LOCALLY _____ OTHER JURISDICTION _____ (INSERT O OR L)

PROPERTY ITEMIZATION	PROPERTY STOLEN/RECOVERED ITEMIZATION, USE THE FOLLOWING FORMAT				
	28. QUANTITY	29. ARTICLE NAME	30. BRAND NAME	31. SERIAL NUMBER	32. CODE
					S R <input type="checkbox"/> <input type="checkbox"/>
					S R <input type="checkbox"/> <input type="checkbox"/>
					S R <input type="checkbox"/> <input type="checkbox"/>
					S R <input type="checkbox"/> <input type="checkbox"/>
					S R <input type="checkbox"/> <input type="checkbox"/>

33. PROPERTY DAMAGE AMOUNT \$ _____

34. INSURANCE COMPANY _____

35. OFFICER ASSAULTED Y N

36. ARSON Y N

37. STRUCTURE CODE _____

38. DAMAGE \$ _____

	ENTERED	CANCELLED
47. CIB	<input type="checkbox"/>	<input type="checkbox"/>
NCIC	<input type="checkbox"/>	<input type="checkbox"/>
OTHER BROADCAST	<input type="checkbox"/>	<input type="checkbox"/>

48. TOTAL AMOUNT PROPERTY STOLEN \$ _____

49. TOTAL AMOUNT PROPERTY RECOVERED \$ _____

50. IS REPORT CONTINUED? YES NO

51. CAUTION INDICATORS, ATLS ETC.

52. DATA PROCESS INFORMATION:

COMPUTER ENTERED DATE 15/17/09

MICROFILM INDEXED INITIAL KS

IS CASE CLASSIFICATION CORRECT? N
IF N HAS CORRECTION BEEN MADE? Y

53. FILE APPROVAL

BY KP

DATE 05/16/09

1. CASE # S99 No 05517		2. CLASSIFICATION 6,310,11		3. CENSUS 1,410,0,2		MANITOWOC COUNTY SHERIFF INCIDENT CARD					
4. INCIDENT CS/S99-00242											
5. INCIDENT LOCATION											
6. NAME - LAST-FIRST-MI ANONYMOUS				7. D.O.B.							
8. ADDRESS				9. TX-HOME							
11. CITY		STATE		ZIP		10. TX-BUSINESS					
12. DETAILS CALLER REPORTS SEEING TRK IN APPLETON AREA MATCHING DESC OF SUSPECT VEH IN H&R.						14. REC'D 7-14-99		15. DISP. 1738		19. REC. BY 932	
						16. 10-23		17. 10-24		20. DIS. BY -	
						13. DAY SUN 1 THU 5 MON 2 FRI 6 TUE 3 SAT 7 WED 4		21. HOW REC'D. 1. 911 2. POLICE RADIO 3. PHONE 4. TTY 5. IN PERSON 6. ON VIEW 7. OFF. OFF DUTY 8. C.B. RADIO 9. OTHER		22. TYPE OF REPORT 1. INCIDENT 2. ACCIDENT 3. CITATION 4. NONE	
										23. STATUS 1. UNFOUNDED 2. PNL 3. OTHER 4. CLEARED 5. EXCEPT CLEARED	
										24. DATE CLEARED 07/22/99	
										25. OFFENSE TYPE 1. ADULT <input type="checkbox"/> NA <input type="checkbox"/> 2. JUVENILE <input type="checkbox"/> 3. UNKNOWN <input type="checkbox"/>	
39. (CODE S-SUSPECT W-WITNESS V-VICTIM O-OTHER)											
CODE	40. NAME-LAST	FIRST	MI	41. D.O.B.	42. ADDRESS				43. TELEPHONE		
0	LIEDERS	NATHAN	J		N Ballard Rd #16, Appleton				54911		
					Cell Phone						

07/14/99 @ 1738 Hrs.: I, Deputy Jost, took a report from an anonymous complainant reference a possible suspect vehicle in the fatal hit and run (incident S99-00242).

The complainant told me there was a blue truck with half the grill broken out parked in a parking lot on N Ballard Rd in the 2300 block. The anonymous person told me the RP on the vehicle was WI truck AK11764. He advised it was either a Ford or GM product pickup truck.

After taking the complaint, I made contact with Appleton PD and had them check for the vehicle. They checked several times for the vehicle; however, they were unable to locate it.

07/18/99: I made contact with Lt. Kathrein from Appleton PD. I gave her NATHAN LIEDERS' name. She later informed me that LIEDERS told officers he was involved in an accident in the past. The accident would have occurred on 10/28/96 as Lt. Kathrein was able to locate the report.

Lt. Kathrein later went and inspected the vehicle herself. She found the damage on the vehicle was consistent with the 10-50 report. She advised me the grill was dented, and half the grill was in fact missing. She told me the vehicle was an S10 model pickup truck. She indicated the damage did not appear to be consistent with the vehicle striking a person.

Based on the information received from Lt. Kathrein, specifically the damage and the fact that it is an S10 model pickup, no further follow-up needs to be done on this specific Crime Stopper. JMjost /bjc

CASE # S99 No 05517

45. IF COMPLAINANT DIFFERENT THEN CALLER, ENTER NAME, ADDRESS, D.O.B., TELEPHONE.

46. IF CODE O (OTHER) IS USED IN FIELD #39, EXPLAIN.

INCIDENT REPORT: NOTE: IF SECTION 22 ABOVE HAS NUMBER 4 CHECKED, DO NOT GO BEYOND THIS LINE WITHOUT RECORDS SECTION BEING ADVISED, OR NO RECORD ENTRIES WILL BE MADE BELOW THIS LINE.

PROPERTY VALUE	26. PROPERTY	A. CURRENCY	B. JEWELRY	C. FURS CLOTHING	D. VEHICLE (LOCAL)	E. OFFICE EQUIPMENT	F. RADIO, TV CAMERAS	G. FIREARMS	H. HOUSE-HOLD GOODS
	STOLEN	\$	\$	\$	\$	\$	\$	\$	\$
	RECOVERED	\$	\$	\$	\$	\$	\$	\$	\$
	26. PROPERTY	I. CONSUMABLES	J. LIVESTOCK	K. DRUGS	L. MARINE ITEMS	M. CONSTRUCTION ITEMS	N. LAWN AND GARDEN	O. SPORTING GOODS	P. MISC BICYCLE
	STOLEN	\$	\$	\$	\$	\$	\$	\$	\$
	RECOVERED	\$	\$	\$	\$	\$	\$	\$	\$

27. PROPERTY RECOVERED: LOCALLY ____ OTHER JURISDICTION ____ (INSERT O OR L)

PROPERTY ITEMIZATION	PROPERTY STOLEN/RECOVERED ITEMIZATION, USE THE FOLLOWING FORMAT				
	28. QUANTITY	29. ARTICLE NAME	30. BRAND NAME	31. SERIAL NUMBER	32. CODE
					S R
					<input type="checkbox"/> <input type="checkbox"/>
					S R
					<input type="checkbox"/> <input type="checkbox"/>
					S R
				<input type="checkbox"/> <input type="checkbox"/>	
				S R	
				<input type="checkbox"/> <input type="checkbox"/>	
				S R	
				<input type="checkbox"/> <input type="checkbox"/>	

33. PROPERTY DAMAGE AMOUNT \$ _____ 34. INSURANCE COMPANY _____

35. OFFICER ASSAULTED Y N 36. ARSON Y N 37. STRUCTURE CODE _____ 38. DAMAGE \$ _____

47. CIB ENTERED CANCELLED
 NCIC
 OTHER BROADCAST

48. TOTAL AMOUNT PROPERTY STOLEN \$ _____

49. TOTAL AMOUNT PROPERTY RECOVERED \$ _____

50. IS REPORT CONTINUED? YES NO

51. CAUTION INDICATORS, ATLS ETC.

52. DATA PROCESS INFORMATION:

COMPUTER ENTERED DATE 1/26/99
 MICROFILM INDEXED INITIAL AS
 IS CASE CLASSIFICATION CORRECT? N
 IF N HAS CORRECTION BEEN MADE? N

53. FILE APPROVAL

BY CK DATE 01/22/99

1. CASE # S99 No 05870 | 2. CLASSIFICATION 6.310.11 | 3. CENSUS 5.210.00

4. INCIDENT CS / S99-00242

5. INCIDENT LOCATION

6. NAME - LAST - FIRST - MI Anony. (2) | 7. D.O.B.

8. ADDRESS | 9. TX-HOME

11. CITY STATE ZIP | 10. TX-BUSINESS

12. DETAILS See Attached Form.

07-25-99 1043

14. REC'D	15. DISP	16. 10-23	17. 10-24
13. DAY			
SUN 1	THU 5		
MON 2	FRI 6		
TUE 3	SAT 7		
WED 4			

MANITOWOC COUNTY SHERIFF
INCIDENT CARD

18. ASSIGNED MISO 989

19. REC. BY 430 | 20. DIS. BY

21. HOW REC'D. 3. PHONE

22. TYPE OF REPORT 1. INCIDENT 2. ACCIDENT 3. CITATION 4. NONE

23. STATUS 3. OTHER

24. DATE CLEARED 07/26/99

25. OFFENSE TYPE 1. ADULT NA 2. JUVENILE 3. UNKNOWN

39. (CODE S-SUSPECT W-WITNESS V-VICTIM O-OTHER)				42. ADDRESS		43. TELEPHONE
CODE	40. NAME-LAST	FIRST	MI	41. D.O.B.		

07/25/99 Officer Colborn checked computer files and found that this vehicle was already checked and did not produce a match. See attached computer printout for further details. lk/v

45. IF COMPLAINANT DIFFERENT THEN CALLER, ENTER NAME, ADDRESS, D.O.B., TELEPHONE.

46. IF CODE O (OTHER) IS USED IN FIELD #39, EXPLAIN.

INCIDENT REPORT: NOTE: IF SECTION 22 ABOVE HAS NUMBER 4 CHECKED, DO NOT GO BEYOND THIS LINE WITHOUT RECORDS SECTION BEING ADVISED, OR NO RECORD ENTRIES WILL BE MADE BELOW THIS LINE.

PROPERTY VALUE	26. PROPERTY	A. CURRENCY	B. JEWELRY	C. FURS CLOTHING	D. VEHICLE (LOCAL)	E. OFFICE EQUIPMENT	F. RADIO, TV CAMERAS	G. FIREARMS	H. HOUSE-HOLD GOODS
	STOLEN	\$	\$	\$	\$	\$	\$	\$	\$
	RECOVERED	\$	\$	\$	\$	\$	\$	\$	\$
	26. PROPERTY	I. CONSUM-ABLES	J. LIVESTOCK	K. DRUGS	L. MARINE ITEMS	M. CONSTRUCTION ITEMS	N. LAWN AND GARDEN	O. SPORTING GOODS	P. MISC BICYCLE
	STOLEN	\$	\$	\$	\$	\$	\$	\$	\$
	RECOVERED	\$	\$	\$	\$	\$	\$	\$	\$

27. PROPERTY RECOVERED: LOCALLY ____ OTHER JURISDICTION ____ (INSERT O OR L)

PROPERTY ITEMIZATION	PROPERTY STOLEN/RECOVERED ITEMIZATION, USE THE FOLLOWING FORMAT				
	28. QUANTITY	29. ARTICLE NAME	30. BRAND NAME	31. SERIAL NUMBER	32. CODE
					S R <input type="checkbox"/> <input type="checkbox"/>
					S R <input type="checkbox"/> <input type="checkbox"/>
					S R <input type="checkbox"/> <input type="checkbox"/>
					S R <input type="checkbox"/> <input type="checkbox"/>
					S R <input type="checkbox"/> <input type="checkbox"/>

33. PROPERTY DAMAGE AMOUNT \$ _____ 34. INSURANCE COMPANY _____

35. OFFICER ASSAULTED Y N 36. ARSON Y N 37. STRUCTURE CODE _____ 38. DAMAGE \$ _____

47. CIB	ENTERED <input type="checkbox"/>	CANCELLED <input type="checkbox"/>	48. TOTAL AMOUNT PROPERTY STOLEN \$ _____
NCIC	<input type="checkbox"/>	<input type="checkbox"/>	
OTHER BROADCAST	<input type="checkbox"/>	<input type="checkbox"/>	
			49. TOTAL AMOUNT PROPERTY RECOVERED \$ _____

50. IS REPORT CONTINUED? YES NO 51. CAUTION INDICATORS, ATLS ETC.

52. DATA PROCESS INFORMATION:

COMPUTER ENTERED DATE 7/26/99

MICROFILM INDEXED INITIAL RS

IS CASE CLASSIFICATION CORRECT? Y N

IF N HAS CORRECTION BEEN MADE? Y N

53. FILE APPROVAL

BY [Signature] DATE 07/26/99

Persons

Aliases

Phone Numbers

Last Name:

First Name:

Middle Name:

Category:

KAUFMANN

PAUL

M

Address:

CTH JJ

Race:

Sex:

Height:

Weight:

Hair Color:

Eyes:

Facial Characteristics:

THK694 1985 SUBURBAN

City:

State:

Zip Code:

MANITOWOC

DOB:

Place Of Birth:

Clothing:

CHECKED NO MATCH

Occupation:

SSN:

FBI Number:

File Number:

Other Number:

S99-689/2650

Family/Associates

Method of Operation

Criminal History

Other

Entered By:

CR

On:

2/16/1999

At:

4:52 PM

Last Modified By:

CR

On:

4/10/1999

At:

10:22 AM

45

1. CASE # S99 No 06358 2. CLASSIFICATION 5M722 3. CENSUS 710000

MANITOWOC COUNTY SHERIFF INCIDENT CARD

4. INCIDENT CS/S99-00242
 5. INCIDENT LOCATION NEENAH
 6. NAME- LAST-FIRST-MI A F TISLER 7. D.O.B.
 8. ADDRESS 9. TX-HOME
 11. CITY STATE ZIP 10. TX-BUSINESS

18. ASSIGNED BUSHMAN 9/9/99
 MTSO 9/29/99

19. DETAILS
 POSSIBLE HIT & RUN SUSPECT
 RECOGNITION AK 63-721 TRK
 81 CHE VAN

14. RECD. 15. DISP. 16. 10-23 17. 10-24
 13. DAY
 SUN 1 THU 5
 MON 2 FRI 6
 TUE 3 SAT 7
 WED 4

20. REC'D BY DIS. BY
 21. HOW REC'D.
 1. 911
 2. POLICE RADIO
 3. PHONE
 4. TTY
 5. IN PERSON
 6. ON VIEW
 7. OFF. OFF DUTY
 8. C.B. RADIO
 9. OTHER
 21A.M.O.
 22. TYPE OF REPORT
 1. INCIDENT
 2. ACCIDENT
 3. CITATION
 4. NONE
 23. STATUS
 1. UNFOUNDED
 2. PNL
 3. OTHER
 4. CLEARED
 5. EXCEPT CLEARED
 24. DATE CLEARED 08/13/99
 25. OFFENSE TYPE
 1. ADULT NA
 2. JUVENILE
 3. UNKNOWN

39. (CODE S-SUSPECT W-WITNESS V-VICTIM O-OTHER)	40. NAME-LAST	FIRST	MI	41. D.O.B.	42. ADDRESS	43. TELEPHONE
S	HAYES	DUANE	J		Wright Ave, Neenah	
O	BARTON	PAUL	A			

08/11/99 @ 1135 Hrs.: I, Lt. M. Bushman, came to MTSO for a meeting. D.I. Tisler handed me a note for a possible vehicle in the HOCHSTETLER hit and run (see incident S99-00242). The vehicle would be in the Forest Junction area. The RP was AK63721. The vehicle should be a 1985 Chevrolet van. The caller wanted to remain anonymous.

08/11/99 @ 2215 Hrs.: Contact was made by phone with CASO. A request to have a squad meet me in the Forest Junction area was made. The RP of AK63721 comes back on a 1981 Chevrolet van listing to DUANE HAYES of Forest Junction. It was my intent to pay HAYES a visit. The CASO officer stated the address of [redacted] Lot #54 is a general overall address for the trailer court in Forest Junction. HAYES' true address is [redacted] Acorn St in the trailer park.

Contact was attempted at this trailer. There was a "For Sale" sign in the window of the trailer. It did not appear as though anyone had lived there for quite some time. Someone, however, was clipping the lawn.

Contact was made with the next door neighbors who stated HAYES moved out at the minimum 3-4 months ago. The neighbor recalled a 1983 blue Chevrolet van which was owned by HAYES. It was also learned HAYES works the 2nd shift at KAY-TEE in Chilton. There was one other individual, a black male, PAUL BARTON, who lived in the trailer with HAYES. BARTON currently lives in Chilton. This location was given to the CASO officer who was familiar. The neighbor also suggested we check with the neighbor to the south as he was much more friendly with HAYES.

Contact was made at trailer #213 where I spoke with the tenant. He stated HAYES no longer lived in the next door trailer, stating he moved out approximately a year ago. When asked what type of vehicle HAYES drives, the neighbor stated he had multiple vehicles during the course of time when he was in the trailer court; however, he specifically noted HAYES was currently driving a 1981 blue Chevrolet van, blue in color. He stated it was not in the best of shape. This neighbor also provided me with HAYES' girlfriend's name, PHYLLIS O'TOOLE, living at [redacted] Wright Ave, Neenah, phone of [redacted]. The neighbor advised the last time he had contact with HAYES, he was living with PHYLLIS.

S99 No 06358

45. IF COMPLAINANT DIFFERENT THEN CALLER, ENTER NAME, ADDRESS, D.O.B., TELEPHONE.

46. IF CODE O (OTHER) IS USED IN FIELD #39, EXPLAIN.

INCIDENT REPORT: NOTE: IF SECTION 22 ABOVE HAS NUMBER 4 CHECKED, DO NOT GO BEYOND THIS LINE WITHOUT RECORDS SECTION BEING ADVISED, OR NO RECORD ENTRIES WILL BE MADE BELOW THIS LINE.

PROPERTY VALUE	26. PROPERTY	A. CURRENCY	B. JEWELRY	C. FURS CLOTHING	D. VEHICLE (LOCAL)	E. OFFICE EQUIPMENT	F. RADIO, TV CAMERAS	G. FIREARMS	H. HOUSE-HOLD GOODS
	STOLEN	\$	\$	\$	\$	\$	\$	\$	\$
	RECOVERED	\$	\$	\$	\$	\$	\$	\$	\$
	26. PROPERTY	I. CONSUMABLES	J. LIVESTOCK	K. DRUGS	L. MARINE ITEMS	M. CONSTRUCTION ITEMS	N. LAWN AND GARDEN	O. SPORTING GOODS	P. MISC BICYCLE
	STOLEN	\$	\$	\$	\$	\$	\$	\$	\$
	RECOVERED	\$	\$	\$	\$	\$	\$	\$	\$

27. PROPERTY RECOVERED: LOCALLY _____ OTHER JURISDICTION _____ (INSERT O OR L)

PROPERTY ITEMIZATION	PROPERTY STOLEN/RECOVERED ITEMIZATION, USE THE FOLLOWING FORMAT			
	28. QUANTITY	29. ARTICLE NAME	30. BRAND NAME	31. SERIAL NUMBER

33. PROPERTY DAMAGE AMOUNT \$ _____

34. INSURANCE COMPANY _____

35. OFFICER ASSAULTED Y N

36. ARSON Y N

37. STRUCTURE CODE _____

38. DAMAGE \$ _____

47. CIB ENTERED CANCELLED

NCIC

OTHER BROADCAST

48. TOTAL AMOUNT PROPERTY STOLEN \$ _____

49. TOTAL AMOUNT PROPERTY RECOVERED \$ _____

50. IS REPORT CONTINUED? YES NO

51. CAUTION INDICATORS, ATLS ETC.

52. DATA PROCESS INFORMATION:

COMPUTER ENTERED DATE 18.17.99

MICROFILM INDEXED INITIAL KS

IS CASE CLASSIFICATION CORRECT? Y N

IF N HAS CORRECTION BEEN MADE? Y N

53. FILE APPROVAL

BY DRB DATE 10/13/99

MANITOWOC COUNTY SHERIFF'S DEPARTMENT
FOLLOW-UP REPORT

Page: 2

CASE NUMBER: 599-010358 CLASSIFICATION: _____

INCIDENT: _____

DATE AND TIME: _____

REPORT CONTINUED:

08/11/99 @ 2235 Hrs.: I, Lt. Bushman, made contact with Neenah PD. Arrangements were made for an officer to do a driveby of [REDACTED] Wright Ave to check for lights on and whether or not the blue van was there. I head to the Neenah area. Within 5 minutes, they called back stating the vehicle was there and there were lights on.

I made contact with DUANE HAYES by phone who was most congenial and invited me to stop by within a short period of time to clear up this matter.

Contact was made with HAYES, and my business was stated. HAYES invited me to look at his 1981 Chevrolet van which was parked in the driveway. He opened the hood, and he explained the damage on the right front fender. There was yellow transfer paint. HAYES stated in January or February some time he slid into a pole at the PICK-N-SAVE in Neenah. The damage was definitely consistent with sliding into a concrete pole. The damage on the right front was most notably in the headlight assembly door, bumper, and right front fender. The vehicle is old, has numerous miles, and was not repaired.

None of the damage under the hood or the damage to the structure was consistent with the HOCHSTETLER incident. It did not appear as though this vehicle had been worked on or repaired in any manner. There was a considerable amount of over-spray from a very old paint job which was conducted, according to HAYES, prior to him receiving the vehicle.

This would not be the vehicle we are looking for in the hit and run. This complaint can be closed out. MJBushman  /bjc

1. CASE # S99 No 07386
 2. CLASSIFICATION K31011, 141011
 3. CENSUS 1942 NIA
 4. INCIDENT CS/S99-00242
 5. INCIDENT LOCATION Hwy CR & Silver Cnk Rd.
 6. NAME - LAST - FIRST - MI Anonymous
 7. D.O.B. [redacted]
 8. ADDRESS [redacted]
 9. TX-HOME [redacted]
 10. TX-BUSINESS [redacted]
 11. CITY STATE ZIP [redacted]
 12. DETAILS
 Officers requests
 incident started
 re: above.

MANITOWOC COUNTY SHERIFF
 INCIDENT CARD
 18. ASSIGNED Colborn 4:30
 19. REC. BY 925
 20. DIS. BY NIA
 21. HOW REC'D.
 1. 911
 2. POLICE RADIO
 3. PHONE
 4. TTY
 5. IN PERSON
 6. ON VIEW
 7. OFF. OFF DUTY
 8. C.B. RADIO
 9. OTHER
 21A. M.O. [redacted]
 22. TYPE OF REPORT
 1. INCIDENT
 2. ACCIDENT
 3. CITATION
 4. NONE
 23. STATUS
 1. UNFOUNDED
 2. PNL
 3. OTHER
 4. CLEARED
 5. EXCEPT CLEARED
 24. DATE CLEARED 10/12/99
 25. OFFENSE TYPE
 1. ADULT NA
 2. JUVENILE
 3. UNKNOWN

39. (CODE S-SUSPECT W-WITNESS V-VICTIM O-OTHER)	40. NAME - LAST	FIRST	MI	41. D.O.B.	42. ADDRESS	43. TELEPHONE
O	[redacted]	[redacted]	[redacted]	[redacted]	[redacted]	[redacted]
O	[redacted]	JEAN	A	[redacted]	[redacted] St, Manitowoc	[redacted]

09-14-99: I, Deputy A. Colborn, received information from MTSO jail staff that a party identified only by the last name of [redacted] had reported to the MTSO and stated she wished to speak with an officer who was investigating incident #S99-00242. Ms. [redacted] identified herself as an employee of [redacted] which is located in the [redacted] in the City of Manitowoc. I was informed by MTSO jail staff that Ms. [redacted] believed a frequent customer of [redacted] may possibly be a suspect for incident #S99-00242.

09-15-99: I, Deputy A. Colborn, responded to [redacted] in the City of Manitowoc at approx. 1300 hours. At that time I was informed by an employee there that there was indeed a [redacted] who was employed by [redacted] I was informed that Ms. [redacted] was currently out making deliveries and was unavailable to speak with me. The employee informed me that they would have [redacted] contact me by telephone up her return to the store at the end of her shift.

09-15-99 @ 1930 hours: I, Deputy A. Colborn, received a telephone call from [redacted] who identified herself as the Ms. [redacted] who had reported to the MTSO jail. [redacted] stated she very much wanted to speak with me and requested that I respond to the Shopko Plaza parking lot where she would speak to me in private in my patrol unit.

I did respond to the Shopko Plaza where I met with [redacted] [redacted] did state that ever since this particular customer had come into [redacted] and began talking about the HOCHSTETLER incident, [redacted] has been "sick to her stomach" and "unable to sleep."

It was obvious to me that whatever this customer had informed [redacted] had made a vivid impression upon [redacted].

[redacted] informed me that there is a regular customer of [redacted] who she knows only by the first name of JEANNE and the nickname of "CRAZY JEANNE". [redacted] informed me that JEANNE was known to drink frequently and frequently brags about her alcohol consumption. [redacted]

S99 No 07386

45. IF COMPLAINANT DIFFERENT THEN CALLER, ENTER NAME, ADDRESS, D.O.B., TELEPHONE.

46. IF CODE O (OTHER) IS USED IN FIELD #39, EXPLAIN.

INCIDENT REPORT: NOTE: IF SECTION 22 ABOVE HAS NUMBER 4 CHECKED, DO NOT GO BEYOND THIS LINE WITHOUT RECORDS SECTION BEING ADVISED, OR NO RECORD ENTRIES WILL BE MADE BELOW THIS LINE.

PROPERTY VALUE	26. PROPERTY	A. CURRENCY	B. JEWELRY	C. FURS CLOTHING	D. VEHICLE (LOCAL)	E. OFFICE EQUIPMENT	F. RADIO, TV CAMERAS	G. FIREARMS	H. HOUSE-HOLD GOODS
	STOLEN	\$	\$	\$	\$	\$	\$	\$	\$
	RECOVERED	\$	\$	\$	\$	\$	\$	\$	\$
	26. PROPERTY	I. CONSUM-ABLES	J. LIVESTOCK	K. DRUGS	L. MARINE ITEMS	M. CONSTRUCTION ITEMS	N. LAWN AND GARDEN	O. SPORTING GOODS	P. MISC BICYCLE
STOLEN	\$	\$	\$	\$	\$	\$	\$	\$	
RECOVERED	\$	\$	\$	\$	\$	\$	\$	\$	

27. PROPERTY RECOVERED: LOCALLY _____ OTHER JURISDICTION _____ (INSERT O OR L)

PROPERTY ITEMIZATION	PROPERTY STOLEN/RECOVERED ITEMIZATION, USE THE FOLLOWING FORMAT			31. SERIAL NUMBER	32. CODE	
	28. QUANTITY	29. ARTICLE NAME	30. BRAND NAME		S	R
					<input type="checkbox"/>	<input type="checkbox"/>
					<input type="checkbox"/>	<input type="checkbox"/>
					<input type="checkbox"/>	<input type="checkbox"/>
					<input type="checkbox"/>	<input type="checkbox"/>
					<input type="checkbox"/>	<input type="checkbox"/>
					<input type="checkbox"/>	<input type="checkbox"/>

33. PROPERTY DAMAGE AMOUNT \$ _____

34. INSURANCE COMPANY _____

35. OFFICER ASSAULTED Y N

36. ARSON Y N

37. STRUCTURE CODE _____ 38. DAMAGE \$ _____

47. CIB ENTERED CANCELLED
 NCIC
 OTHER BROADCAST

48. TOTAL AMOUNT PROPERTY STOLEN \$ _____

49. TOTAL AMOUNT PROPERTY RECOVERED \$ _____

50. IS REPORT CONTINUED? YES NO

51. CAUTION INDICATORS, ATLS ETC.

52. DATA PROCESS INFORMATION:

COMPUTER ENTERED DATE 9/24/99
 MICROFILM INDEXED INITIAL KS

IS CASE CLASSIFICATION CORRECT? Y N
 IF N HAS CORRECTION BEEN MADE? Y N

53. FILE APPROVAL

BY KS DATE 09/24/99

MANITOWOC COUNTY SHERIFF'S DEPARTMENT
FOLLOW-UP REPORT

Page: 2

CASE NUMBER: S99-07386 CLASSIFICATION: _____

INCIDENT: _____

DATE AND TIME: _____

REPORT CONTINUED:

states that almost every time JEANNE comes to [REDACTED] she is intoxicated in varying degrees.

[REDACTED] stated on the particular day in question, which occurred approx. 2 weeks ago, JEANNE again came into [REDACTED]. [REDACTED] states that she was the employee who waited on JEANNE and that JEANNE, at this particular time, was sober although suffering from what [REDACTED] described as a "hangover."

[REDACTED] states that JEANNE engaged her in conversation asking, "What would happen to the person who ran over that HOCHSTETLER kid?" [REDACTED] stated that she acted emotionally and answered JEANNE by stating, "I hope that whoever did it goes to prison for life." [REDACTED] states that JEANNE then asked her a question something to the effect of "Even if it was a woman who did it?"

[REDACTED] she began to grow very alarmed by JEANNE's actions and felt that JEANNE was on the brink of confessing to the entire matter. [REDACTED] states that JEANNE also asked her "If somebody told you that they killed that kid and they were drinking, would you believe them?" [REDACTED] stated she replied, "Yes, I would believe them."

[REDACTED] states that after talking about the HOCHSTETLER incident, JEANNE changed the subject and stated, "I was so drunk last night that I realized I needed help so I drove my truck around the city all night squealing tires but I couldn't get arrested." [REDACTED] stated she asked JEANNE why she did this to which JEANNE replied, "Cuz I wanna see what jail is like."

[REDACTED] states that she believes JEANNE owns a beat up car with make, model and registration plate unknown, as well as a truck also with make, model and registration plate unknown. [REDACTED] further states that JEANNE has a brother whose first name begins with the letter "D". Apparently JEANNE and this brother go out drinking frequently almost every night. [REDACTED] further states that JEANNE frequently rides a bike around the City of Manitowoc and is a frequent customer of [REDACTED] and stops in at least once a week. [REDACTED] stated that she believes JEANNE had told her this information on Wednesday, 09-08-99.

[REDACTED] states that after talking about the HOCHSTETLER incident, JEANNE changed the subject and asked [REDACTED] if she knew of "any good psychiatrists in the area." JEANNE further states that she asked [REDACTED] frequently about patient confidentiality issues which [REDACTED] stated JEANNE would have to take up with her psychiatrist. [REDACTED] stated she then advised JEANNE to locate a confident psychiatrist via the phone book to which JEANNE did state that she is currently on medication for depression.

[REDACTED] described JEANNE as a white female, mid to late 40's, approx. 5'5" to 5'7" tall. [REDACTED] stated that JEANNE weighs approx. 200 lbs. and wears her brown hair pulled back in a pony tail with the pony tail usually pinned to the back of her head. [REDACTED] further states that JEANNE squints while reading which lets [REDACTED] believe that JEANNE has some vision problems. [REDACTED] states that

MANITOWOC COUNTY SHERIFF'S DEPARTMENT
FOLLOW-UP REPORT

Page: 3

CASE NUMBER: S99-07386 CLASSIFICATION: _____

INCIDENT: _____

DATE AND TIME: _____

REPORT CONTINUED:

JEANNE has either brown or green eyes but she is positive they are not blue. [REDACTED] further states that JEANNE generally wears t-shirts with the sleeves rolled up with a pack of cigarettes in the sleeve of the t-shirt, pegged jeans worn in a cuff, and tennis shoes or sandals. [REDACTED] further states JEANNE has one ear that is pierced 6 to 8 times and wears numerous hoops and studs in this ear. Apparently the earrings start at the top of JEANNE's ear and go all the way down to the lobe portion. Again, [REDACTED] reiterated that JEANNE frequently drinks a lot and frequently brags about her alcohol consumption.

[REDACTED] was given my business card with the instructions that should JEANNE return to [REDACTED] that [REDACTED] contact MTSO immediately. [REDACTED] did state that she would comply with my instructions and further stated she would attempt to get JEANNE's last name or a registration plate number of whatever vehicle JEANNE uses to come to Sally's Beauty Supply in.

09-16-99: I, Deputy A.Colborn, contacted Lt. M.Bushman at his residence and informed him of this incident and the investigation into it thus far.

I, Deputy A.Colborn, also contacted MTPD detective division and inquired if they had any connections or any contacts with a person who goes by the nickname of "CRAZY JEANNE." At this time, MTPD was unable to assist me but stated that they would also look into trying to identify JEANNE.

09-16-99 @ 2030 hours: I, Deputy A.Colborn, spoke with Lt. Mark Anderson. Lt. Mark Anderson did check his metro drug intelligence data base to attempt to match the nickname "CRAZY JEANNE" with a name but he was unsuccessful.

The investigation into this incident is continuing pending contact from [REDACTED] or contact with JEANNE/CRAZY JEANNE. CA Colborn/ps

09/20/99: While on my regular day off, I (Deputy A. Colborn) received information at my residence that CRAZY JEANNE who I was looking for for this incident was actually JEAN [REDACTED]. The information that I received indicated JEAN [REDACTED] did in fact live behind SHOPKO in the [REDACTED] block of [REDACTED].

09/22/99 @ 1800 Hrs.: I, Deputy Colborn, was able to locate JEAN [REDACTED] at [REDACTED], Manitowoc. It should be noted this residence is behind SHOPKO. Prior to making contact with JEAN, I observed parked in the garage a maroon 1981 Pontiac Lemans 4-door bearing WI RP HAJ569. I also observed a 1994 GMC S10 or S15 style Blazer bearing WI RP LNJ569. A check of these 2 vehicle RPs through WI DOT revealed the Pontiac was registered to [REDACTED] and the 1994 GMC truck was registered to JEAN [REDACTED].

I then made contact with JEAN [REDACTED] and spoke to her about any involvement or information she may have on incident S99-00242. The answers to my questions led me

MANITOWOC COUNTY SHERIFF'S DEPARTMENT
FOLLOW-UP REPORT

Page: 4

CASE NUMBER: 599-07386 CLASSIFICATION: _____

INCIDENT: _____

DATE AND TIME: _____

REPORT CONTINUED:

to believe that JEAN was being evasive in her answers. This prompted me to contact MTSO Det. Michel who did respond to JEAN'S residence.

Det. Michel then conducted a lengthy interview with JEAN at MTSO with JEAN'S consent.

After completing the interview with JEAN, Det. Michel informed me, at this time, he does not consider JEAN a suspect for this incident. It should be noted, both during my interview and the interview with Det. Michel, JEAN admitted to frequenting [REDACTED] as well as admitting to her nickname of CRAZY JEANNE.

No further action taken at this time. It does not appear JEAN [REDACTED] has any knowledge or is involved in incident S99-00242. It should further be noted JEAN'S vehicle (the 1994 GMC truck) is an S15 style vehicle which would eliminate it as a suspect vehicle for incident S99-00242. A copy of this incident addition should be forwarded to incident commander, Lt. M. Bushman, upon completion of typing.
ALColborn. *ALC* /bjc

1. CASE # S99 No 07461	2. CLASSIFICATION 630.11	3. CENSL 7.01000
4. INCIDENT CS/S99-00242		
5. INCIDENT LOCATION		
6. NAME- LAST-FIRST-MI GBPD	7. D.O.B. 1040	
8. ADDRESS		9. TX-HOME
11. CITY	STATE	ZIP
10. TX-BUSINESS		
12. DETAILS GBPD CALLED REGARDING CRIMESTOPPER. - SEE ATTACHED FAX		

MANITOWOC COUNTY SHERIFF INCIDENT CARD			
18. ASSIGNED LT. BUSHMAN		41911	
MTSO		929	
19. REC. BY 948	20. DIS. BY	22. TYPE OF REPORT <input checked="" type="radio"/> INCIDENT <input type="radio"/> ACCIDENT <input type="radio"/> CITATION <input type="radio"/> NONE	
21. HOW REC'D. 1. 911 2. POLICE RADIO <input checked="" type="radio"/> 3. PHONE 4. TTY 5. IN PERSON 6. ON VIEW 7. OFF. OFF DUTY 8. C.B. RADIO 9. OTHER		23. STATUS 1. UNFOUNDED 2. PNL <input checked="" type="radio"/> 3. OTHER 4. CLEARED 5. EXCEPT CLEARED	
21A. M.O.		24. DATE CLEARED 09/17/99	
		25. OFFENSE TYPE 1. ADULT <input type="checkbox"/> NA <input checked="" type="checkbox"/> 2. JUVENILE <input type="checkbox"/> 3. UNKNOWN <input type="checkbox"/>	

09/17/99 2045

14. REC'D	15. DISP	16. 10-23	17. 10-24
13. DAY			
SUN 1	THU 5		
MON 2	FRI 6		
TUE 3	SAT 7		
WED 4			

39. (CODE S-SUSPECT W-WITNESS V-VICTIM O-OTHER)	40. NAME-LAST	FIRST	MI	41. D.O.B.	42. ADDRESS	43. TELEPHONE
O	JOHNSTON	Patricia	J	[REDACTED]	Patti Ln., Marinette WI 54143	

09-17-99 @ 2045 hours: GBPD received a Crimestoppers tip regarding the hit and run accident, S99-00242. Officer L. Wery, #344, made contact with myself, Lt. Bushman, at MTSO by phone. She took the information by phone and put it on a regular Crimestopper tip sheet. The caller stated that she may have seen the vehicle that was involved in a hit and run accident that killed a boy in Sturgeon Bay a while ago. The caller states the vehicle was hand-painted dark blue with many handmade repairs made to the front grill and front area of the truck. There is still tape left on the body from the paint job. The truck is in rough shape. It was seen in front of Papa John's Pizza Palace in Peshtigo at approx. 6:00 p.m. this evening. The caller waited to see if anyone got in but no one showed up. The caller felt that there should be contact made. The vehicle is described as an older Chevrolet truck, dark blue, with Wis. RP #AM36971.

The registration comes back to a PATRICIA J. JOHNSTON in the Marinette area. Officer Wery advised that the information had been passed on to Marinette Co. Sheriff's Dept.

At 2110 hours: I received phone contact in squad #61 from Officer Jeff Hildelink from Marinette County Sheriff's Dept. He did locate the vehicle in question in Marinette and snapped several polaroid photographs of the vehicle. He did not make contact with the owner, however, was familiar with the female owner and she does work at the Papa John's restaurant where it was parked. I did relay to Officer Hildelink several specific pieces of information reference the hit and run. There were several similarities in that the vehicle was a 1985 Chevrolet truck, however, it was a Silverado addition, which makes double headlight on each side inconsistent with that of our suspect vehicle. The grill is smashed on the passenger side, however, the Chevrolet emblem and the corner pieces of grill work are still attached. As far as Officer Hildelink could see, there was no great structural sheet metal damage, however, parts could have been replaced. He stated the wall holding the radiator and the radiator have not been damaged, however, again they may have been replaced. The inconsistencies with the headlight assemblies and the grill style lead me to believe this would not be the suspect vehicle and the extent of the damage is not excessive which would be the case in our hit and run. Officer Hildelink did advise he will make contact with the owner and attempt to locate the vehicle.

S99 No 07

1 2 3 4 5 6 7 8 9 10 11 12

45. IF COMPLAINANT DIFFERENT THEN CALLER, ENTER NAME, ADDRESS, D.O.B., TELEPHONE.

46. IF CODE O (OTHER) IS USED IN FIELD #39, EXPLAIN.

INCIDENT REPORT: NOTE: IF SECTION 22 ABOVE HAS NUMBER 4 CHECKED, DO NOT GO BEYOND THIS LINE WITHOUT RECORDS SECTION BEING ADVISED, OR NO RECORD ENTRIES WILL BE MADE BELOW THIS LINE.

PROPERTY VALUE	26. PROPERTY	A. CURRENCY	B. JEWELRY	C. FURS CLOTHING	D. VEHICLE (LOCAL)	E. OFFICE EQUIPMENT	F. RADIO, TV CAMERAS	G. FIREARMS	H. HOUSE-HOLD GOODS
	STOLEN	\$	\$	\$	\$	\$	\$	\$	\$
	RECOVERED	\$	\$	\$	\$	\$	\$	\$	\$
	26. PROPERTY	I. CONSUMABLES	J. LIVESTOCK	K. DRUGS	L. MARINE ITEMS	M. CONSTRUCTION ITEMS	N. LAWN AND GARDEN	O. SPORTING GOODS	P. MISC BICYCLE
	STOLEN	\$	\$	\$	\$	\$	\$	\$	\$
	RECOVERED	\$	\$	\$	\$	\$	\$	\$	\$

27. PROPERTY RECOVERED: LOCALLY ____ OTHER JURISDICTION ____ (INSERT O OR L)

PROPERTY ITEMIZATION	PROPERTY STOLEN/RECOVERED ITEMIZATION, USE THE FOLLOWING FORMAT				
	28. QUANTITY	29. ARTICLE NAME	30. BRAND NAME	31. SERIAL NUMBER	32. CODE
					S R <input type="checkbox"/> <input type="checkbox"/>
					S R <input type="checkbox"/> <input type="checkbox"/>
					S R <input type="checkbox"/> <input type="checkbox"/>
					S R <input type="checkbox"/> <input type="checkbox"/>
					S R <input type="checkbox"/> <input type="checkbox"/>

33. PROPERTY DAMAGE AMOUNT \$ _____ 34. INSURANCE COMPANY _____

35. OFFICER ASSAULTED Y N 36. ARSON Y N 37. STRUCTURE CODE _____ 38. DAMAGE \$ _____

47. CIE ENTERED CANCELLED

NCIC

OTHER BROADCAST

48. TOTAL AMOUNT PROPERTY STOLEN \$ _____

49. TOTAL AMOUNT PROPERTY RECOVERED \$ _____

50. IS REPORT CONTINUED? YES NO

51. CAUTION INDICATORS, ATLS ETC.

52. DATA PROCESS INFORMATION:

COMPUTER ENTERED DATE 9/24/99

MICROFILM INDEXED INITIAL KS

53. FILE APPROVAL

IS CASE CLASSIFICATION CORRECT? Y N

IF N HAS CORRECTION BEEN MADE? Y N

BY [Signature] DATE 09/21/99

MARINETTE POLICE DEPARTMENT

P.O. BOX 135
■ HALL AVENUE :
MARINETTE, WISCONSIN 54143-135



INVESTIGATOR

JEFF HILBELINK

Phone: [REDACTED]
Fax: [REDACTED]
Pager: [REDACTED]

SEP-17-1999 20:49

GREEN BAY POLICE [REDACTED]

[REDACTED] P.01/02



Department of Police

James M. Lewis
Chief of Police

TO: Marinette P.D., Ma^{nitowoc} SO, Peshtigo SO

FROM: GREEN BAY POLICE DEPARTMENT

SUBJECT: Crime Stoppers Tip

DATE: 9 17 99

[REDACTED]

DESTINATION FAX NUMBER:

NUMBER OF PAGES SENT (INCLUDING THIS COVER):

SPECIAL NOTES AND/OR COMMENTS:

Contact Buschman - Manitowoc SO @
[REDACTED] - [REDACTED] - [REDACTED] for details and if
there is contact w/vehicle
July 344

This message is intended only for the use of the individual or entity to which it is addressed and may contain information that is privileged, confidential, and exempt from disclosure under applicable law. If the reader of this message is not the intended recipient or the employee or agent responsible for delivering the message to the intended recipient, you are hereby notified that any dissemination, distribution, or copying of this communication is strictly prohibited. If you have received this communication in error, please notify us immediately by telephone and return the original message to us at the address below via the U. S. Postal Service. Thank you.

Date/Time: 9/19/99 9:20:24

Crimes Management System Page: 1
Program: CMS301 Complaint Report

Case No.: 1-99-002317 MARINETTE POLICE DEPARTMENT

Date of Occurrence.: 9/17/99 thru 9/17/99 Time of Occur.: 20:48 thru 20:48
Date of Report.....: 9/18/99 Time of Report: 10:21
Dispatched.....: 9/18/99 @ 10:21 Responded.....: @ 0:00
Arrived.....: 9/18/99 @ 10:21 Cleared.....: 9/18/99 @ 10:21

Day of the Week...: Friday Spc.Indicator.:
Common Name.....: CITY HALL
Incident Location.: HALL AVE
Incident Cty/ST/PR: MARINETTE WI ZIP: 54143
County.....: NONACT
Location Type.....:
Beat Assignment...: Investigation Bureau MAP Ref...: 03306COM
District.....: Statements Taken
Folder Status.... : Folder Started
Department Classif: ASSIST OTHER AGENCIES
Reporting Officer.: JEFFREY L HILBELINK
Case Status.....: Closed/Inactive Date: 9/19/99
Alcohol Related...: Unknown
Drugs Related.....: Unknown

***** V E R I F I C A T I O N I N F O R M A T I O N *****

Reporting Officer.: 9/17/99 Employee: JEFFREY L HILBELINK
Data Reviewed By..: 9/17/99 Employee: JEFFREY L HILBELINK
Report Entered On.: 9/19/99 Employee: JEFFREY L HILBELINK

***** C A S E M A N A G E M E N T I N F O R M A T I O N *****

Case Disposition.: Closed/Inactive NONACT Date: 9/19/99
Case Forwarded To:

***** V E H I C L E I N F O R M A T I O N *****

** D A M A G E D ** V E H I C L E # 1
UCR Prop Type: Trucks
Type of Vehicle.: Year: 1985
Make.: Chevrolet Model: Silverado Permit#:
Style: Pick Up Color: Blue Dk / Gray
License #: AM36971 ST: WI Country....:
VIN #...:
Vehicle Damaged Code:
Damaged/Stolen Value: \$0. Disposit`n:
Insured (Y/N).....: Insured By:
Controlling Officer.:
Veh Feature/Oddity..: Paint Scheme
Keys in Vehicle.....: Vehicle Locked:
Lein Holder.....:
Stolen Location.....: MARINETTE AVE
City/ST/PR....: MARINETTE WI
NCIC #.....: State.:
TIME Ent Date. TIME Can Date.
Misc. ID #....:

Date/Time: 9/19/99 9:20:24

Crimes Management System Page: 2
Complaint Report

Program: CMS301

Case No.: 1-99-002317 MARINETTE POLICE DEPARTMENT (Continued)

Recovered By.:
Recovery Loc.: Date:
City/ST/PR: Time: 0:00
\$Value: \$0.

Recovery Code:
Owner Notifd.: By Whom:

***** P E R S O N I N F O R M A T I O N *****

* C O M P L A I N A N T * INFORMATION # 1
Name: MICHAEL BUSCHMAN DOB.:
Addr: 1025 S 9TH ST SSN.: 000000000
City: MANITOWOC ST: WI ZIP: 54220 Phn#: 715/000-0000
POB.: ST: Country: Bus#: [REDACTED]
Empl: Bus#: [REDACTED]
Occp: LT. INVESTIGATOR
Race.....: White Sex.: Male
Ethnic Org.:
OL #.....: DL ST: Country:
Age.....: Misc#:
Height.....: 000 Ft./in.
Weight.....: lbs

* R E P O R T I N G P E R S O N * INFORMATION # 1
Busn: GREEN BAY POLICE DEPARTMENT Misc#:
Addr: [REDACTED] S ADAMS ST SSN.: 000000000
City: GREEN BAY ST: WI ZIP: 543014582 Phn#: [REDACTED]
Bus#: [REDACTED]

* O T H E R P E R S O N * INFORMATION # 1
Name: PATRICIA JOAN JOHNSTON DOB.: [REDACTED]
Addr: [REDACTED] N PATTI LN SSN.: [REDACTED]
City: MARINETTE ST: WI ZIP: 541430000 Phn#: [REDACTED]
POB.: ST: WI Country: Bus#:
Empl: Bus#: [REDACTED]
Occp:
Race.....: White Sex.: Female
Ethnic Org.:
OL #.....: [REDACTED] DL ST: WI Country: United States
Age.....: 34 Misc#: 305
Height.....: 503 Ft./in.
Weight.....: 130 lbs

* W I T N E S S * INFORMATION # 2
Name: JEFFREY L HILBELINK DOB.:
Addr: [REDACTED] HALL AVE Apt: PO [REDACTED] SSN.: 000000000
City: MARINETTE ST: WI ZIP: 000054143 Phn#:
POB.: ST: WI Country: Bus#:
Empl: MARINETTE POLICE DEPARTMENT Bus#: [REDACTED]
Occp: INVESTIGATOR
Race.....: White Sex.: Male

Date/Time: 9/19/99 9:20:24

Crimes Management System Page: 3
Complaint Report

Prog: CMS301

Case No.: 1-99-002317 MARINETTE POLICE DEPARTMENT (Continued)

Ethnic Org.: Non-Hispanic Origin
OL #.....: DL ST: Country: Misc#:
Age.....: 39
Height.....: 000 Ft./in.
Weight.....: lbs

***** N A R R A T I V E # 1 *****
ORIGINAL Reported By: HILBELINK, JEFFREY L. 9/19/99
Entered By.: HILBELINK, JEFFREY L. 0/00/00

Green Bay Crime Stoppers contacted Marinette Police Department by Fax and advised that a suspect vehicle in a Manitowoc homicide investigation was parked at Papa Johns. Investigator Hilbelink advised and followed up. Manitowoc S99-242 Supplement to follow. Inv Hilbelink

GREEN BAY AREA CRIME STOPPERS INTERVIEW FORM

Caller Code # 99- 83

Date of Crime: 1/11/99 Time: _____ AM/PM Location: _____

Suspect Information

Last Name: _____ First: _____ M.I.: _____ DOB: 1/1

Address: _____ City: _____ State: _____ Phone: _____

Description

Race: White Black Indian Hispanic Oriental Unknown Sex: Male Female Ht: _____ Wt: _____ #

Hair: _____

Scars/Marks/Tatoos: _____

Is suspect armed? Yes No Weapon: _____

Vehicle Year: older Make: Chev Color: dk blue

Body style: 2Dr 4Dr Hatchback Convertible Van Truck Truck Cap Truck Cap Color: _____

Lic#: AM 36 971 State: WI

Unusual features or markings: _____

Employed by: _____ Known Associates: _____

Additional Information

Caller states may have seen the vehicle that was involved in a hit and run that killed a boy in Sturgeon Bay a while ago. Caller states the vehicle was hand painted dk. blue many hand made repairs to front grill and front area of truck. There is still tape left on body. Truck is in rough shape. Seen in front of Papa Johns in Peshtigo appr 6pm tonight. Caller wanted to see if anyone got in but no one showed up. Caller wanted no contact.

THIS REPORT IS NOT TO BE PLACED IN CASE FILE

Type of Crime: Homicide Sexual Assault Armed Robbery Arson Aggravated Battery Burglary/Home Invasion Auto Theft Narcotics Theft Forgery/Fraud Vice Fugitives Weapons Kidnapping Criminal Damage Traffic Warrant WI's Most Wanted Other

Where did caller hear about Crime Stoppers? TV Radio Paper Friend Advertising Call back Date: 1/1

Date of call: 9/17/99 Time: 0804 AM PM Call taker: Silvey 344

Filed to: Northwoc Agency Called: _____



INVESTIGATIONS

City of Marinette Police Department

Investigators –
Drug Enforcement Officers:

Joe Corry
[REDACTED]

Pete Springer
[REDACTED]

Inspector Harold Techmeier
[REDACTED]

Detective Sergeant John Mabry
[REDACTED]

Investigator Jeff Hilbelink
[REDACTED]

Investigator Jeff Hilbelink
Marinette Police Department Complaint # 99-2317
Manitowoc County Sheriffs Dept. Complaint #S 99- 00424

09/19/1999

Green Bay Police Department Crime Stoppers called our department and relayed that the Police Department had received a call from someone that had seen a blue pick up truck at the Papa Johns in Peshtigo that matched a hit and run homicide in Manitowoc County. Green Bay advised dispatch that they had learned that Papa John's was in Marinette and asked that an investigator check on this vehicle. Green Bay Police also sent a FAX with the information received by them.

I proceeded to [REDACTED] Marinette Avenue in Marinette and located the in the parking lot at T&T Fermanich gas, a truck matching the description given to me. It was a 1985 Chevrolet, Silverado 10, Pick up truck. It had Wisconsin registration AM- 36971 on a white and red Wisconsin plates. It was dark blue in color and appeared that it had been recently painted and the painting was not done professionally. There was masking tape still on the chrome and trim of the wheel wells. The bottom portion of the truck had a primer gray color. There was damage to the passenger side grill area between the headlamps and Chevrolet symbol. Photos were taken of the truck. I contacted Lt. Mike Buschman of the Manitowoc County Sheriff's Department. I told Mike of my findings

and it was preliminarily determined that the vehicle that I had observed was not what he was looking for. Mike asked if I would speak with the registered owner, complete a report and send him the information that I had obtained.

On 09/19/1999 at approximately 10:00 hours I went to [REDACTED] Patti lane Marinette, Wisconsin. There I spoke with the registered owner Patricia Joan Johnston DOB. [REDACTED]. I explained to a very guarded Ms. Johnston that met me in the front yard that I wanted to ask her questions about her truck. I had identified myself as an investigator for the Marinette Police Department and explained that I was following up on a complaint for Manitowoc County Sheriff's Department. Ms Johnston asked to see a photo police identification. I provided Ms Johnston an ID card. The following questions were asked of Ms Johnston:

Do you know anyone in Manitowoc County?

Reply: No

Have you ever been in Manitowoc County?

Reply: No

Has this truck been in Manitowoc County?

Reply: I had applied for a job just south of Green Bay in the last four months. Is that in Manitowoc County?

What was the name of the town you applied for this job?

Reply: I don't remember

What kind of job did you apply for?

Reply: A home health care worker. My son was with

How long have you had this truck?

Reply: About a year and one half

When was it painted?

Reply: Two or three months ago

Where was it painted?

Reply: Here

Who painted the truck?

Reply: Family

Who in the Family?

Reply: Why?

Patti then went into the house and brought back a paper and pencil and asked me to write my name on the paper. I wrote my name and work address and the phone numbers. Patti asked how long I had worked at the police department I answered thirteen years. Patti said my son and I painted the truck.

What color was the truck?

Reply: The same color

Are there any damaged parts that have been removed?

Reply: No

How was the grill damaged?

Reply: I hit a fence post on this road. Patti pointed to a fence.

When was that?

Reply: I don't know

Did you report it to the Sheriff's Department?

Reply: Yah, I paid the fine and everything.

I photographed the truck in the yard and explained the nature of why I was asking the questions. I thanked Patti for here time and left.

I went to Marinette County Sheriff's Department and their records indicate that on April 2nd of 1999 a complaint was generated involving Patti and her 1985 Chevy pick up truck in a hit and run accident involving the truck hitting a fence. A copy of our file and all photos' has been forwarded to Manitowoc County Sheriff's Department, Attention Lt. Mike Buschman. Investigator Hilbelink

1. CASE # S99 No 06761 2. CLASSIFICATION 0.310.11 3. CENSUS 1,410,02

4. INCIDENT CS/S99-00242

5. INCIDENT LOCATION Various

6. LAST FIRST MI 7. D.O.B.

8. ADDRESS 9. TX-HOME

11. CITY STATE ZIP 10. TX-BUSINESS

12. DETAILS
 Calls delivers newspaper in
 Newton area - has list of four
 poss matches to suspect veh.
 See attached.

1620
 8-25-99
 14. REC'D
 15. DISP
 16. 10-23
 17. 10-24
 13. DAY
 SUN 1 THU 5
 MON 2 FRI 6
 TUE 3 SAT 7
 WED 4

MANITOWOC COUNTY SHERIFF
 INCIDENT CARD

18. ASSIGNED
 MTSO 9/2/99
 O'Hearn 7/5/99

19. REC. BY 932 20. DIS. BY 932

21. HOW REC'D.
 1. 911
 2. POLICE RADIO
 3. PHONE
 4. TTY
 5. IN PERSON
 6. ON VIEW
 7. OFF. OFF DUTY
 8. C.B. RADIO
 9. OTHER

22. TYPE OF REPORT
 1. INCIDENT
 2. ACCIDENT
 3. CITATION
 4. NONE

23. STATUS
 1. UNFOUNDED
 2. PNL
 3. OTHER
 4. CLEARED
 5. EXCEPT CLEARED

24. DATE CLEARED 09/10/99

25. OFFENSE TYPE
 1. ADULT NA
 2. JUVENILE
 3. UNKNOWN

39. (CODE S-SUSPECT W-WITNESS V-VICTIM O-OTHER)	40. NAME-LAST	FIRST	MI	41. D.O.B.	42. ADDRESS	43. TELEPHONE
V	HOCHSTETLER	RICHARD	D	05/13/81	Deceased	
O	[REDACTED]	[REDACTED]	[REDACTED]	[REDACTED]	[REDACTED]	[REDACTED]
O	OLSON	JOANNE	M	[REDACTED]	Gass Lake Rd, Manitowoc	[REDACTED]
O	[REDACTED]	[REDACTED]	[REDACTED]	[REDACTED]	8607 Center Rd	[REDACTED]
O	SHARER	FREDERICK	W	[REDACTED]	Troy St, Wausau 54403	[REDACTED]
O	NEWTON MEAT MARKET	[REDACTED]	[REDACTED]	[REDACTED]	CTH U, Newton	[REDACTED]
O	WAGNER	NICHOLAS	S	[REDACTED]	CTH U, Newton	[REDACTED]
O	MAYER	RALPH	R	[REDACTED]	Lueloff Rd, Sheboygan 53083	[REDACTED]

09/01/99 @ 0835 Hrs.: I, Lt. O'Hearn, received a call from D.I. Tisler who advised he had a list of 4 Crimestoppers which came in from an individual by the name of [REDACTED]. The 4 Crimestoppers were listed on a Crimestopper Interview Form. D.I. Tisler wished for me to go and check on the 4 Crimestoppers concerning the hit and run HOCHSTETLER fatality which took place on 01/10/99 on CTH CR.

I started with checking the first residence at [REDACTED] Gass Lake Rd. I met with the owner of the residence, JOANNE OLSON. She stated her truck has been checked numerous times before, but she was very, very willing to allow me to check the vehicle in question. The vehicle was a Dodge Ram truck bearing RP BG10765. It was a gray Dodge truck, not a Chevy. It had no damage whatsoever to the front or hood area. A close check indicated it appeared nothing had been changed or redone on the vehicle. This vehicle was crossed off the Crimestoppers list.

The next vehicle I checked was a vehicle bearing RP BC96209 at the address of [REDACTED] Center Rd. It should be noted, when I arrived and checked with the residence, I found no one was home. I saw the truck in question (red and tan in color) had the front end and engine missing. It was in plain view in the back yard of this residence. I went back and found the RP was not BC96209 but BG96209. The vehicle looks as if it has been on blocks and sitting in this area for quite some time. In fact, the front end and engine of the vehicle is missing. The vehicle is a Chevy pickup truck, but I could not get close enough to check on the vehicle due to the fact there was a very unfriendly rottweiler chained to the vehicle. Please place a copy of this incident in Lt. M. Bushman's drawer to see if this vehicle at this address of [REDACTED] Center Rd has been prior checked as I could not contact anyone at the residence during my shift.

S99 No 06761

MANITOWOC COUNTY SHERIFF'S DEPARTMENT
FOLLOW-UP REPORT

CASE NUMBER: 599-06761 CLASSIFICATION: _____

INCIDENT: _____

DATE AND TIME: _____

REPORT CONTINUED:

I, Lt. O'Hearn, checked the 3rd Crimestoppers. We were given a description of an unknown RP which was a blue truck next to a red barn across from the NEWTON MEAT MARKET. I located this residence at [REDACTED] CTH U. I found there was a blue GMC vehicle in the yard bearing WI truck RP AH10537. A check of the residence indicated there was no one home, but the vehicle was in plain view. I looked at the truck and found it was in good shape, had no damage, and did not appear to have any type of replacement parts put on the vehicle. It should be noted the owner of this residence is NICK WAGNER. His 10-28 is attached from another vehicle. The 10-28 from the vehicle in his yard is also attached. Again, there appeared to be no damage to this vehicle.

The 4th and final Crimestoppers which was given by [REDACTED] to MTSO indicated there was a brown Chevy Scottsdale in the Newton area at the meat market. When I arrived, I found no brown Chevy Scottsdale in the area bearing RP 65691F. In fact, I ran this RP, and it came back to a residence in Sheboygan. I talked and spoke with the employees of NEWTON MEAT MARKET. They indicated none of the employees have a vehicle which matches this description and that it could have been a customer. It should be noted I had Dispatch contact SBSO with this RP, indicating the vehicle came back to RALPH MAYER from Lueloff Rd, Sheboygan. SBSO contacted MAYER, checked the vehicle, and found the vehicle had no damage.

It should be noted all 4 of the Crimestopper reports given by [REDACTED] have been checked and should be placed into the report as such. TKOHearn /bjc

09/03/99: Put a copy of this report in Lt. M. Bushman's drawer in Patrol with highlighted information per Lt. O'Hearn. BJChristianson

1. CASE # S99 No 07915 | 2. CLASSIFICATION 6310.11 | 3. CENSUS 17010.00

4. INCIDENT 05/S99-00242

5. INCIDENT LOCATION Montello

6. NAME LAST-FIRST-MI Anonymous (2) | 7. D.O.B.

8. ADDRESS | 9. TX-HOME

11. CITY STATE ZIP | 10. TX-BUSINESS

12. DETAILS See attached.

7/20/99
 6/10/02
 13. DAY
 SUN 1 THUR 5
 MON 2 FRI 6
 TUE 3 SAT 7
 WED 4

MANITOWOC COUNTY SHERIFF INCIDENT CARD

18. ASSIGNED MTSO 9219

Colborn 43#

19. REC. BY 435 | 20. DIS. BY 935 | 22. TYPE OF REPORT 1 INCIDENT 2 ACCIDENT 3 CITATION 4 NONE

21. HOW REC'D. 1. 911 2. POLICE RADIO 3. PHONE 4. TTY 5. IN PERSON 6. ON VIEW 7. OFF. OFF DUTY 8. C.B. RADIO 9. OTHER | 23. STATUS 1. UNFOUNDED 2. PNL 3. OTHER 4. CLEARED 5. EXCEPT CLEARED

24. DATE CLEARED 10/03/99 | 25. OFFENSE TYPE 1. ADULT 2. JUVENILE 3. UNKNOWN

39. (CODE S-SUSPECT W-WITNESS V-VICTIM O-OTHER)	40. NAME-LAST	FIRST	MI	41. D.O.B.	42. ADDRESS	43. TELEPHONE
O	PROTHERO	Craig	H596BT	[REDACTED]	[REDACTED] Adams St., Two Rivers WI	

10-01-99: I, Deputy A Colborn, received a request from MTSO dispatch that I enter the dispatch center and speak with an individual who was calling reference incident #S99-00242. I did make contact with the caller who informed me that sometime during the 2nd or 3rd week of August, he observed a vehicle that he felt may have been involved in incident #S99-00242.

The caller informed me that he was on Hwy 23 outside the City of Montello, WI. The caller further informed me that he observed what he described as a gray, silver or white Chevrolet full size pickup truck being operated into the City of Montello on Hwy 23. The caller informed me that the vehicle appeared to have damage to the front passenger side grill area.

The caller stated he was unsure of the color but knew it to be gray, silver or white. The caller further informed me he was unable to obtain any registration plate number or any other distinguishing features. The caller further informed me he has not been in the City of Montello since that time.

The caller did request that I contact the Dept. of Motor Vehicle and run a registration check of every Chevrolet pickup truck assigned to the Montello area. I informed him that I would be unable to do this and that would be something that would have to be checked out by Montello area law enforcement. I did request that if the caller continues to vacation in the Montello area and again sees the vehicle, that he try to obtain a registration plate number and contact us immediately. The caller did agree to do so.

At this time, no further action taken pending recontact from Mr. PROTHERO. AColborn/ps *agc*

CASE # S99 No 07915

45. IF COMPLAINANT DIFFERENT THEN CALLER, ENTER NAME, ADDRESS, D.O.B., TELEPHONE.

46. IF CODE O (OTHER) IS USED IN FIELD #39, EXPLAIN.

INCIDENT REPORT: NOTE: IF SECTION 22 ABOVE HAS NUMBER 4 CHECKED, DO NOT GO BEYOND THIS LINE WITHOUT RECORDS SECTION BEING ADVISED, OR NO RECORD ENTRIES WILL BE MADE BELOW THIS LINE.

PROPERTY VALUE	26. PROPERTY	A. CURRENCY	B. JEWELRY	C. FURS CLOTHING	D. VEHICLE (LOCAL)	E. OFFICE EQUIPMENT	F. RADIO, TV CAMERAS	G. FIREARMS	H. HOUSE-HOLD GOODS
	STOLEN	\$	\$	\$	\$	\$	\$	\$	\$
	RECOVERED	\$	\$	\$	\$	\$	\$	\$	\$
	26. PROPERTY	I. CONSUM-ABLES	J. LIVESTOCK	K. DRUGS	L. MARINE ITEMS	M. CONSTRUCTION ITEMS	N. LAWN AND GARDEN	O. SPORTING GOODS	P. MISC BICYCLE
	STOLEN	\$	\$	\$	\$	\$	\$	\$	\$
	RECOVERED	\$	\$	\$	\$	\$	\$	\$	\$

27. PROPERTY RECOVERED: LOCALLY _____ OTHER JURISDICTION _____ (INSERT O OR L)

PROPERTY ITEMIZATION	PROPERTY STOLEN/RECOVERED ITEMIZATION, USE THE FOLLOWING FORMAT				
	28. QUANTITY	29. ARTICLE NAME	30. BRAND NAME	31. SERIAL NUMBER	32. CODE
					S R <input type="checkbox"/> <input type="checkbox"/>
					S R <input type="checkbox"/> <input type="checkbox"/>
					S R <input type="checkbox"/> <input type="checkbox"/>
					S R <input type="checkbox"/> <input type="checkbox"/>

33. PROPERTY DAMAGE AMOUNT \$ _____

34. INSURANCE COMPANY _____

35. OFFICER ASSAULTED Y N

36. ARSON Y N

37. STRUCTURE CODE _____

38. DAMAGE \$ _____

	ENTERED	CANCELLED
47 CIB	<input type="checkbox"/>	<input type="checkbox"/>
NCIC	<input type="checkbox"/>	<input type="checkbox"/>
OTHER BROADCAST	<input type="checkbox"/>	<input type="checkbox"/>

48. TOTAL AMOUNT PROPERTY STOLEN \$ _____

49. TOTAL AMOUNT PROPERTY RECOVERED \$ _____

50. IS REPORT CONTINUED? YES NO

51. CAUTION INDICATORS, ATLS ETC.

52. DATA PROCESS INFORMATION:

COMPUTER ENTERED DATE 10.16.99
 MICROFILM INDEXED INITIAL RS

53. FILE APPROVAL

IS CASE CLASSIFICATION CORRECT?
 IF N HAS CORRECTION BEEN MADE? Y N

BY WAS DATE 10.05.99

1. CASE # **S99 No 08574** 2. CLASSIFICATION **5.718** 3. CENSUS **14002**

MANITOWOC COUNTY SHERIFF INCIDENT CARD

4. INCIDENT **CS/S99-00242**

18. ASSIGNED **MTSO 929**

5. INCIDENT LOCATION **Silver Ck Rd. & CR**

Fox Point PD 943

6. NAME - LAST - FIRST - MI **Anonymous** 7. D.O.B.

R. Tisler 137

8. ADDRESS 9. TX-HOME

19. REC. BY **925** 20. DIS. BY **925**

11. CITY STATE ZIP 10. TX-BUSINESS

22. TYPE OF REPORT
 1. INCIDENT
 2. ACCIDENT
 3. CITATION
 4. NONE

12. DETAILS **Two pictures mailed to**

14. REC'D 15. DISP 16. 10-23 17. 10-24
10/21/99
appex-1300
1451

21. HOW REC'D.
 1. 911
 2. POLICE RADIO
 3. PHONE
 4. TTY
 5. IN PERSON
 6. ON VIEW
 7. OFF OFF DUTY
 8. C.B. RADIO
 9. OTHER

D.I. Tisler of possible

23. STATUS
 1. UNFOUNDED
 2. PNL
 3. OTHER
 4. CLEARED
 5. EXCEPT CLEARED

Suspect vehicle & suspects

13. DAY
 SUN 1 THU 5
 MON 2 FRI 6
 TUE 3 SAT 7
 WED 4

24. DATE CLEARED **05/16/00**

residence in H+R Fatal accident at above location.

25. OFFENSE TYPE
 1. ADULT
 2. JUVENILE
 3. UNKNOWN

39. (CODE S-SUSPECT W-WITNESS V-VICTIM O-OTHER)						
CODE	40. NAME-LAST	FIRST	MI	41. D.O.B.	42. ADDRESS	43. TELEPHONE

A piece of paper indicates the pictures were taken in the 6600 block of N. Lake Drive in Fox Point, WI. (Near the intersection of E. Appletree.) SE SE

10-21-99 Officer Riese of Fox Point PD checked the 6600 block of N. Lake Dr. and indicated the house in the photograph would be [redacted] N. Lake Dr. Subject residing there there would be either 1) Daniel W. Bruckner DOB [redacted]

Owns a '85 Chev truck, RP# BK61853.
 He was stopped on 01-24-99 for having a headlight out on a '89 Dodge Trk/van with RP#KPM621

- or -2) Daniel H. Bruckner DOB [redacted].

They request we forward our initial report to them and any other pertinent information Their fax number is [redacted]. Please send information to the attention of Inv. Gehring. They do not want to make personal contact without more background information on the case. SE SE

10/27/99 Dep. Insp Tisler received information from Inv. Gehring that the Milwaukee address of Daniel Bruckner had been checked and no vehicle of the type involved was present. It was mentioned that the area is one where numerous junked vehicles are abandoned. No personal contact with Mr. Bruckner. 10-27 & 10-28 both show this as his address and does show the 85 chev truck as being current for registration. Inv. Gehring will not make further attempts unless directed to do so. Address listed for Mr. Bruckner is [redacted] W. Silver Spring Dr. Apt 5, Milwaukee. RJ Tisler Telephone # for Det. Goerhing [redacted]

S99 No 08574

45. IF COMPLAINANT DIFFERENT THEN CALLER, ENTER NAME, ADDRESS, D.O.B., TELEPHONE.

46. IF CODE O (OTHER) IS USED IN FIELD #39, EXPLAIN.

INCIDENT REPORT: NOTE: IF SECTION 22 ABOVE HAS NUMBER 4 CHECKED, DO NOT GO BEYOND THIS LINE WITHOUT RECORDS SECTION BEING ADVISED, OR NO RECORD ENTRIES WILL BE MADE BELOW THIS LINE.

PROPERTY VALUE	26. PROPERTY	A. CURRENCY	B. JEWELRY	C. FURS CLOTHING	D. VEHICLE (LOCAL)	E. OFFICE EQUIPMENT	F. RADIO, TV CAMERAS	G. FIREARMS	H. HOUSE-HOLD GOODS
	STOLEN	\$	\$	\$	\$	\$	\$	\$	\$
	RECOVERED	\$	\$	\$	\$	\$	\$	\$	\$
	26. PROPERTY	I. CONSUM-ABLES	J. LIVESTOCK	K. DRUGS	L. MARINE ITEMS	M. CONSTRUCTION ITEMS	N. LAWN AND GARDEN	O. SPORTING GOODS	P. MISC BICYCLE
STOLEN	\$	\$	\$	\$	\$	\$	\$	\$	
RECOVERED	\$	\$	\$	\$	\$	\$	\$	\$	

27. PROPERTY RECOVERED: LOCALLY ____ OTHER JURISDICTION ____ (INSERT O OR L)

PROPERTY ITEMIZATION	PROPERTY STOLEN/RECOVERED ITEMIZATION, USE THE FOLLOWING FORMAT				
	28. QUANTITY	29. ARTICLE NAME	30. BRAND NAME	31. SERIAL NUMBER	32. CODE
					S R <input type="checkbox"/> <input type="checkbox"/>
					S R <input type="checkbox"/> <input type="checkbox"/>
					S R <input type="checkbox"/> <input type="checkbox"/>
					S R <input type="checkbox"/> <input type="checkbox"/>

33. PROPERTY DAMAGE AMOUNT \$ _____ 34. INSURANCE COMPANY _____

35. OFFICER ASSAULTED Y N 36. ARSON Y N 37. STRUCTURE CODE _____ 38. DAMAGE \$ _____

47. CIB ENTERED CANCELLED
 NCIC
 OTHER BROADCAST

48. TOTAL AMOUNT PROPERTY STOLEN \$ _____

49. TOTAL AMOUNT PROPERTY RECOVERED \$ _____

50. IS REPORT CONTINUED? YES NO

51. CAUTION INDICATORS, ATLS ETC.

52. DATA PROCESS INFORMATION:

COMPUTER ENTERED DATE 15/17/00
 MICROFILM INDEXED INITIAL AS

53. FILE APPROVAL

IS CASE CLASSIFICATION CORRECT? (Y) N
 IF N HAS CORRECTION BEEN MADE? (Y) N

BY R DATE 05/16/00

6600 Block of
N. Lake Drive in
Fox Point, WI.

"T." intersection with
E. Appletree.

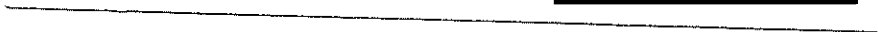
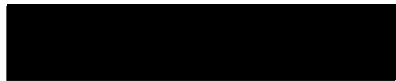



To: ~~Shorewood PD~~ Fox Point PD
From: Manitowoc Co. Sheriff
~~re: admin msg #138400~~
2

1. CASE # S99 No 08849 | 2. CLASSIFICATION 630.11 | 3. CENSUS 021000

4. INCIDENT CS - 599-00242

5. INCIDENT LOCATION

6. NAME - LAST - FIRST - MI Anonyms | 7. D.O.B.

8. ADDRESS | 9. TX-HOME

11. CITY STATE ZIP | 10. TX-BUSINESS

12. DETAILS

10-30-99 0307

MANITOWOC COUNTY SHERIFF
INCIDENT CARD

18. ASSIGNED Colborn 41312

Janssen 4114

MITSO 929

19. REC. BY 928 | 20. DIS. BY

21. HOW REC'D. 5 IN PERSON

22. TYPE-OF REPORT 1. INCIDENT 2. ACCIDENT 3. CITATION 4. NONE

23. STATUS 1. UNFOUNDED 2. PNL 3. OTHER 4. CLEARED 5. EXCEPT CLEARED

24. DATE CLEARED 11/10/99

25. OFFENSE TYPE 1. ADULT 2. JUVENILE 3. UNKNOWN

14. REC'D. 15. DISP. 16. 10-23 17. 10-24
13. DAY
SUN 1 THU 5
MON 2 FRI 6
TUE 3 SAT 7
WED 4

39. CODE	40. NAME-LAST	FIRST	MI	41. D.O.B.	42. ADDRESS	43. TELEPHONE
0	KUBICHKA	CHERISH	N		20th St, Two Rivers	
0	DEBAUCHE	TIMOTHY	A		20th St, Two Rivers	

10/30/99: I, Deputy A. Colborn, was assigned this incident by the 2000-0400-hour Shift Commander, Sgt. Janssen. Preliminary information received from Sgt. Janssen was that CHERISH KUBICHKA and TIMOTHY DEBAUCHE who apparently reside together own a 1987 Chevrolet truck which was taken off the road very shortly after S99-00242 occurred.

An alpha check through WI DOT revealed WI RP SFZ266 was assigned to KUBICHKA who resides at 20th St, Two Rivers. The RP was assigned to a 1987 Chevy truck.

10/31/99: I responded to 20th St, Two Rivers, where I located a blue with white top 1987 Chevy Blazer parked in the driveway. I observed this Blazer to bear WI RP SFZ266. I further observed the VIN on the vehicle parked in the driveway did match that VIN shown on the registration check. This showed this RP did belong with this particular vehicle.

I observed there was no front end damage whatsoever to this vehicle. The grill was entirely intact as were both fenders. Both front fenders appeared to be free of dents, and the windshield was free of cracks. Also, the front bumper did not appear to be damaged in any way.

After ensuring the VIN was correct for the vehicle, I took no further action. At this time, this vehicle does not appear to be the suspect vehicle for S99-00242. A copy of this incident should be forwarded to the incident commander, Lt. M. Bushman, for his review.

ALColborn *ac* /bjc

CASE # S99 No 08849

45. IF COMPLAINANT DIFFERENT THEN CALLER, ENTER NAME, ADDRESS, D.O.B., TELEPHONE.

46. IF CODE O (OTHER) IS USED IN FIELD #39, EXPLAIN.

INCIDENT REPORT: NOTE: IF SECTION 22 ABOVE HAS NUMBER 4 CHECKED, DO NOT GO BEYOND THIS LINE WITHOUT RECORDS SECTION BEING ADVISED, OR NO RECORD ENTRIES WILL BE MADE BELOW THIS LINE.

PROPERTY VALUE	26. PROPERTY	A. CURRENCY	B. JEWELRY	C. FURS CLOTHING	D. VEHICLE (LOCAL)	E. OFFICE EQUIPMENT	F. RADIO, TV CAMERAS	G. FIREARMS	H. HOUSEHOLD GOODS
	STOLEN	\$	\$	\$	\$	\$	\$	\$	\$
	RECOVERED	\$	\$	\$	\$	\$	\$	\$	\$
	26. PROPERTY	I. CONSUMABLES	J. LIVESTOCK	K. DRUGS	L. MARINE ITEMS	M. CONSTRUCTION ITEMS	N. LAWN AND GARDEN	O. SPORTING GOODS	P. MISC BICYCLE
STOLEN	\$	\$	\$	\$	\$	\$	\$	\$	
RECOVERED	\$	\$	\$	\$	\$	\$	\$	\$	

27. PROPERTY RECOVERED: LOCALLY _____ OTHER JURISDICTION _____ (INSERT O OR L)

PROPERTY ITEMIZATION	PROPERTY STOLEN/RECOVERED ITEMIZATION, USE THE FOLLOWING FORMAT				
	28. QUANTITY	29. ARTICLE NAME	30. BRAND NAME	31. SERIAL NUMBER	
					S <input type="checkbox"/> R <input type="checkbox"/>
					S <input type="checkbox"/> R <input type="checkbox"/>
					S <input type="checkbox"/> R <input type="checkbox"/>
					S <input type="checkbox"/> R <input type="checkbox"/>

33. PROPERTY DAMAGE AMOUNT \$ _____ 34. INSURANCE COMPANY _____

35. OFFICER ASSAULTED Y N 36. ARSON Y N 37. STRUCTURE CODE _____ 38. DAMAGE \$ _____

47. CIB ENTERED CANCELLED
 NCIC
 OTHER BROADCAST

48. TOTAL AMOUNT PROPERTY STOLEN \$ _____
 49. TOTAL AMOUNT PROPERTY RECOVERED \$ _____

50. IS REPORT CONTINUED? YES NO 51. CAUTION INDICATORS, ATLS ETC. _____

52. DATA PROCESS INFORMATION:
 COMPUTER ENTERED DATE 11/10/99
 MICROFILM INDEXED INITIAL KS
 IS CASE CLASSIFICATION CORRECT? Y N
 IF N HAS CORRECTION BEEN MADE? Y N

53. FILE APPROVAL
 BY [Signature] DATE 11/09/99

1. CASE # S99 No 08814 2. CLASSIFICATION 630.11 3. CENSUS 7.0000

4. INCIDENT CS/S99-00242

5. INCIDENT LOCATION 933 Sunset Ct Omro WI

6. NAME - LAST-FIRST-MI [REDACTED] 7. D.O.B. [REDACTED]

8. ADDRESS [REDACTED] 9. TX-HOME [REDACTED]

11. CITY [REDACTED] STATE [REDACTED] ZIP [REDACTED] 10. TX-BUSINESS [REDACTED]

12. DETAILS
 Caller states a veh matching the descrip of H+R parked @ above loc. Blue + white unkn. RP or damage

654 10299

MANITOWOC COUNTY SHERIFF INCIDENT CARD

18. ASSIGNED
 WISO 9413
 COLBORN 4312
 WISO 929

19. REC. BY 926 20. DIS. BY 923
 21. HOW REC'D.
 1. 911
 2. POLICE RADIO
 3. PHONE
 4. TTY
 5. IN PERSON
 6. ON VIEW
 7. OFF. OFF DUTY
 8. C.B. RADIO
 9. OTHER
 21A. M.O.
 22. TYPE OF REPORT
 1. INCIDENT
 2. ACCIDENT
 3. CITATION
 4. NONE
 23. STATUS
 1. UNFOUNDED
 2. RNL
 3. OTHER
 4. CLEARED
 5. EXCEPT CLEARED
 24. DATE CLEARED 11/29/99
 25. OFFENSE TYPE
 1. ADULT NA
 2. JUVENILE
 3. UNKNOWN

14. REC'D. 15. DISP 16. 10-23 17. 10-24
 13. DAY
 SUN 1 THU 5
 MON 2 FRI 6
 TUE 3 SAT 7
 WED 4

39. (CODE S-SUSPECT W-WITNESS V-VICTIM O-OTHER)

CODE	40. NAME-LAST	FIRST	MI	41. D.O.B.	42. ADDRESS	43. TELEPHONE
W	BUISH	LESLIE	E	[REDACTED]	E Main St #2, Omro 54963	[REDACTED]

TTY was sent to Winnebago SO for Omro PD to check for this vehicle. See TTY messages attached. lak923

11/01/99 Upon return to work from my days off I noticed no additional notations on this incident with response from Omro PD. Another TTY was sent with same request and to respond if any additional information was obtained. lak923

11/17/99: I, Deputy A. Colborn, was assigned this incident from the 2000-0400-hour Shift Commander, Sgt. Janssen.

11/18/99: I contacted and spoke with Omro PD Chief Vonderloh. I asked Chief Vonderloh if he could possibly dispatch an officer to check at [REDACTED] Sunset Ct, Omro, for a Suburban, blue in color, which allegedly has front end damage and could possibly be a match for the suspect vehicle in incident S99-00242. Chief Vonderloh stated he would have an officer investigate this incident.

11/21/99: I received through interdepartmental mail the attached interoffice memorandum showing a picture of the vehicle described to us by [REDACTED]. I observed the vehicle to be a GMC. The suspect vehicle for incident S99-00242 is a Chevrolet. I further noted Omro PD included pictures of the vehicle (see attached). The pictures showed the front bumper, grill, front fenders, and hood to appear to be free of any sort of damage. The other picture was a picture of the engine compartment of the vehicle which showed the fan shroud to be free of damage. Noted on the fan shroud is a chalk mark with "-30" written on the shroud. Apparently, the coolant in the radiator was checked at -30 degrees on 03/09/89. Again, it does not appear there is any structural or upper radiator support damage to this vehicle. Also noted on the bottom of the picture is the VIN and a note from Officer Harn that the VIN and RP do match the vehicle.

At this time, it does not appear this vehicle is the suspect vehicle for incident S99-00242. A copy of this incident should be forwarded to the incident commander. Lt. M

CASE # S99 No 08814

45. IF COMPLAINANT DIFFERENT THEN CALLER, ENTER NAME, ADDRESS, D.O.B., TELEPHONE.

46. IF CODE O (OTHER) IS USED IN FIELD #39, EXPLAIN.

INCIDENT REPORT: NOTE: IF SECTION 22 ABOVE HAS NUMBER 4 CHECKED, DO NOT GO BEYOND THIS LINE WITHOUT RECORDS SECTION BEING ADVISED, OR NO RECORD ENTRIES WILL BE MADE BELOW THIS LINE.

PROPERTY VALUE	26. PROPERTY	A. CURRENCY	B. JEWELRY	C. FURS CLOTHING	D. VEHICLE (LOCAL)	E. OFFICE EQUIPMENT	F. RADIO, TV CAMERAS	G. FIREARMS	H. HOUSE-HOLD GOODS
	STOLEN	\$	\$	\$	\$	\$	\$	\$	\$
	RECOVERED	\$	\$	\$	\$	\$	\$	\$	\$
	26. PROPERTY	I. CONSUMABLES	J. LIVESTOCK	K. DRUGS	L. MARINE ITEMS	M. CONSTRUCTION ITEMS	N. LAWN AND GARDEN	O. SPORTING GOODS	P. MISC BICYCLE
	STOLEN	\$	\$	\$	\$	\$	\$	\$	\$
	RECOVERED	\$	\$	\$	\$	\$	\$	\$	\$

27. PROPERTY RECOVERED: LOCALLY _____ OTHER JURISDICTION _____ (INSERT O OR L)

PROPERTY ITEMIZATION	PROPERTY STOLEN/RECOVERED ITEMIZATION, USE THE FOLLOWING FORMAT			
	28. QUANTITY	29. ARTICLE NAME	30. BRAND NAME	31. SERIAL NUMBER

33. PROPERTY DAMAGE AMOUNT \$ _____ 34. INSURANCE COMPANY _____

35. OFFICER ASSAULTED Y N 36. ARSON Y N 37. STRUCTURE CODE _____ 38. DAMAGE \$ _____

47. CIB	ENTERED <input type="checkbox"/>	CANCELLED <input type="checkbox"/>	48. TOTAL AMOUNT PROPERTY STOLEN \$ _____
NCIC	<input type="checkbox"/>	<input type="checkbox"/>	
OTHER BROADCAST	<input type="checkbox"/>	<input type="checkbox"/>	
			49. TOTAL AMOUNT PROPERTY RECOVERED \$ _____

50. IS REPORT CONTINUED? YES NO 51. CAUTION INDICATORS, ATLS ETC.

52. DATA PROCESS INFORMATION:

COMPUTER ENTERED DATE 12/3/99

MICROFILM INDEXED INITIAL KS

IS CASE CLASSIFICATION CORRECT? N

IF N HAS CORRECTION BEEN MADE? N

53. FILE APPROVAL

BY [Signature] DATE 11/29/99

interoffice
MEMORANDUM

To: Dep A Colborn
From: John d. Vonderloh
Subject: ■ Sunset Crt vehicle
Date: November 19, 1999

This is a picture of the vehicle from ■ Sunset Crt that you wanted a picture of. I hope that this will answer your questions from Omro.

Hope you solve your case.

Sincerely,

John D. Vonderloh, Chief

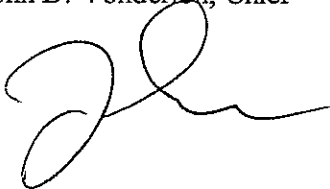

7/18/99 1430 HRS Carson Hwy (36)

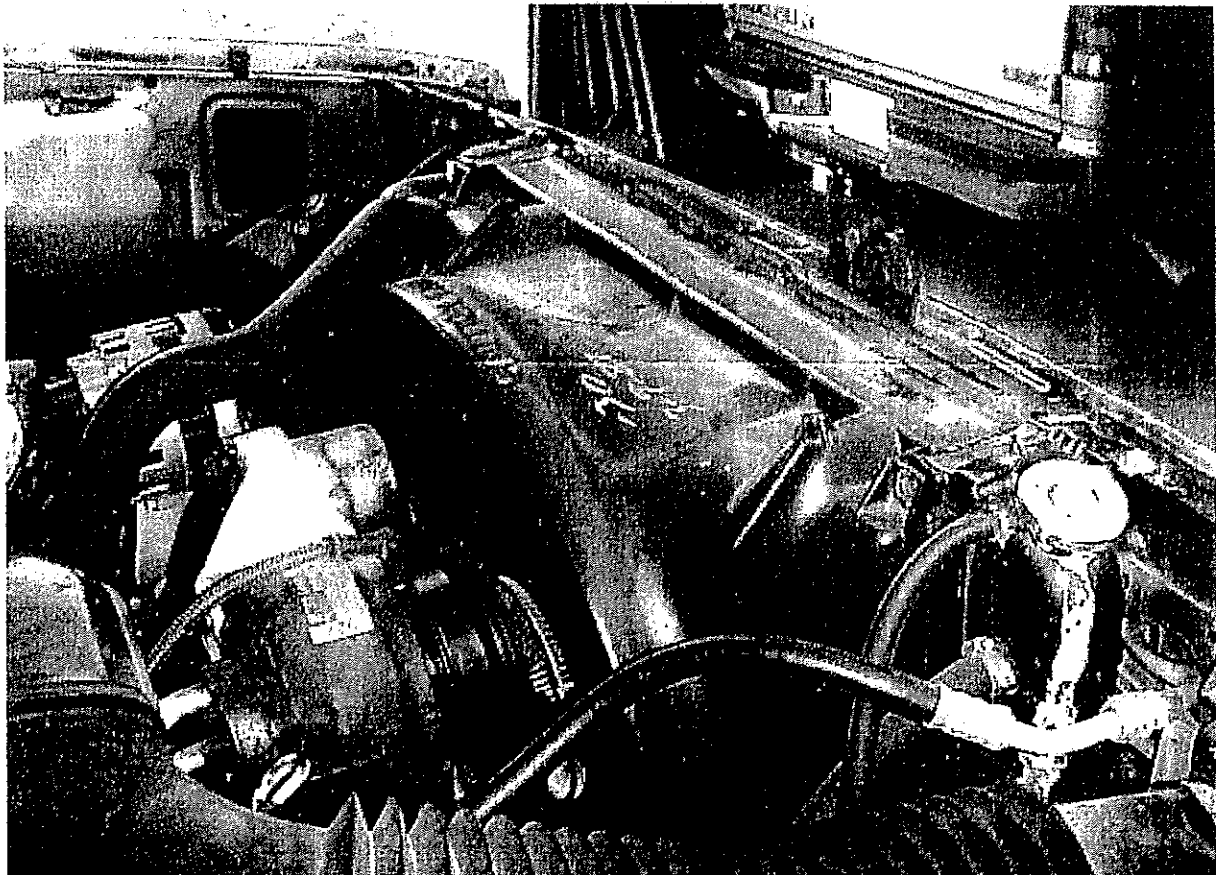

1. CASE # S99 No 09051 | 2. CLASSIFICATION 630.1 | 3. CENSUS 70000

4. INCIDENT CS/S99-00242

5. INCIDENT LOCATION

6. NAME LAST-FIRST-MI Anony. | 7. D.O.B.

8. ADDRESS | 9. TX-HOME

11. CITY STATE ZIP | 10. TX-BUSINESS

12. DETAILS
Vehicle mentioned in Post Crescent article on 1-31-99 that a Grand Am was burned beyond recognition in an alcohol related incident.

110599 1029

MANITOWOC COUNTY SHERIFF INCIDENT CARD

18. ASSIGNED
 MT-SD
 Bushman 441

19. REC. BY 920 | 20. DIS. BY

21. HOW REC'D.
 1. 911
 2. POLICE RADIO
 3. PHONE
 4. TTY
 5. IN PERSON
 6. ON VIEW
 7. OFF. OFF DUTY
 8. C.B. RADIO
 9. OTHER

22. TYPE OF REPORT
 1. INCIDENT
 2. ACCIDENT
 3. CITATION
 4. NONE

23. STATUS
 1. UNFOUNDED
 2. PNL
 3. OTHER
 4. CLEARED
 5. EXCEPT CLEARED

24. DATE CLEARED 11/14/99

25. OFFENSE TYPE
 1. ADULT NA
 2. JUVENILE
 3. UNKNOWN

14. REC'D | 15. DISP | 16. 10-23 | 17. 10-24

13. DAY
 SUN 1 THU 5
 MON 2 FR 6
 TUE 3 SAT 7
 WED 4

39. (CODE S-SUSPECT W-WITNESS V-VICTIM O-OTHER)						
CODE	40. NAME-LAST	FIRST	MI	41. D.O.B.	42. ADDRESS	43. TELEPHONE

11-05-99 Caller believes this vehicle was found in Neenah or Menasha. sbraun920
 11/14/99 2120hrs How is this related to S99-00242? M.J.Bushman

S99 No 09051

45. IF COMPLAINANT DIFFERENT THEN CALLER, ENTER NAME, ADDRESS, D.O.B., TELEPHONE.

46. IF CODE O (OTHER) IS USED IN FIELD #39, EXPLAIN.

INCIDENT REPORT: NOTE: IF SECTION 22 ABOVE HAS NUMBER 4 CHECKED, DO NOT GO BEYOND THIS LINE WITHOUT RECORDS SECTION BEING ADVISED, OR NO RECORD ENTRIES WILL BE MADE BELOW THIS LINE.

PROPERTY VALUE	26. PROPERTY	A. CURRENCY	B. JEWELRY	C. FURS CLOTHING	D. VEHICLE (LOCAL)	E. OFFICE EQUIPMENT	F. RADIO, TV CAMERAS	G. FIREARMS	H. HOUSE-HOLD GOODS
	STOLEN	\$	\$	\$	\$	\$	\$	\$	\$
	RECOVERED	\$	\$	\$	\$	\$	\$	\$	\$
	26. PROPERTY	I. CONSUMABLES	J. LIVESTOCK	K. DRUGS	L. MARINE ITEMS	M. CONSTRUCTION ITEMS	N. LAWN AND GARDEN	O. SPORTING GOODS	P. MISC BICYCLE
	STOLEN	\$	\$	\$	\$	\$	\$	\$	\$
	RECOVERED	\$	\$	\$	\$	\$	\$	\$	\$

27. PROPERTY RECOVERED: LOCALLY _____ OTHER JURISDICTION _____ (INSERT O OR L)

PROPERTY ITEMIZATION	PROPERTY STOLEN/RECOVERED ITEMIZATION, USE THE FOLLOWING FORMAT				
	28. QUANTITY	29. ARTICLE NAME	30. BRAND NAME	31. SERIAL NUMBER	32. CODE
					S R <input type="checkbox"/> <input type="checkbox"/>
					S R <input type="checkbox"/> <input type="checkbox"/>
					S R <input type="checkbox"/> <input type="checkbox"/>
					S R <input type="checkbox"/> <input type="checkbox"/>

33. PROPERTY DAMAGE AMOUNT \$ _____ 34. INSURANCE COMPANY _____

35. OFFICER ASSAULTED Y N 36. ARSON Y N 37. STRUCTURE CODE _____ 38. DAMAGE \$ _____

47. CIB	ENTERED <input type="checkbox"/>	CANCELLED <input type="checkbox"/>	48. TOTAL AMOUNT PROPERTY STOLEN \$ _____
NCIC	<input type="checkbox"/>	<input type="checkbox"/>	
OTHER BROADCAST	<input type="checkbox"/>	<input type="checkbox"/>	49. TOTAL AMOUNT PROPERTY RECOVERED \$ _____

50. IS REPORT CONTINUED? YES NO 51. CAUTION INDICATORS, ATLS ETC.

52. DATA PROCESS INFORMATION:

COMPUTER ENTERED DATE 11/15/99

MICROFILM INDEXED INITIAL KS

IS CASE CLASSIFICATION CORRECT? Y N

IF N HAS CORRECTION BEEN MADE? Y N

53. FILE APPROVAL

BY [Signature] DATE 11/15/99

1. CASE # S99 No 09059		2. CLASSIFICATION 63011		3. CENSUS 114002		MANITOWOC COUNTY SHERIFF INCIDENT CARD					
4. INCIDENT CS/599-00242											
5. INCIDENT LOCATION Silver Ck Rd. & CR						19. REC. BY 925		20. DIS. BY 925		22. TYPE OF REPORT 1. INCIDENT 2. ACCIDENT 3. CITATION 4. NONE	
6. NAME - LAST - FIRST - MI Anonymous				7. D.O.B.		21. HOW REC'D. 1. 911 2. POLICE RADIO 3. PHONE 4. TTY 5. IN PERSON 6. ON VIEW 7. OFF OFF DUTY 8. C.B. RADIO 9. OTHER		23. STATUS 1. UNFOUNDED 2. PNL 3. OTHER 4. CLEARED 5. EXCEPT CLEARED		24. DATE CLEARED 11/10/99	
8. ADDRESS				9. TX-HOME		13. DAY SUN 1 THU 5 MON 2 FRI 6 TUE 3 SAT 7 WED 4		25. OFFENSE TYPE 1. ADULT <input type="checkbox"/> NA <input type="checkbox"/> 2. JUVENILE <input type="checkbox"/> 3. UNKNOWN <input type="checkbox"/>			
11. CITY		STATE		ZIP		10. TX-BUSINESS					
12. DETAILS Vehicle matching description of one in fatal H+R is parked at [redacted] S. 15th, Manitowoc						14. REC'D		15. DISP		16. 10-23	
						17. 10-24					
39. (CODE S-SUSPECT W-WITNESS V-VICTIM O-OTHER)											
CODE	40. NAME-LAST	FIRST	MI	41. D.O.B.	42. ADDRESS				43. TELEPHONE		
O	MARCUS	22103	JAMES	E	[redacted] Franklin St, Manitowoc				[redacted]		
O	KOLLATH	13515	DAVID	W	[redacted] S 15th St, Manitowoc						

11/05/99 @ 1447 Hrs.: I, Deputy Jost, was advised by Dispatch of a Crime Stopper report regarding the fatal hit and run of RICK HOCHSTETLER. I was informed there was a brown-colored pickup truck in the rear of [redacted] S 15th St, Manitowoc, which had damage to the front end and had been parked in the garage since February 1999.

11/05/99 @ 1640 Hrs.: Deputy Riddle and I made contact with DAVID KOLLATH who indicated the vehicle belonged to JAMES MARCUS. KOLLATH indicated MARCUS brought the vehicle over to his residence to store in his garage until MARCUS could repair and get the vehicle running. According to KOLLATH, MARCUS had not driven the vehicle prior to this as it was not in running condition.

I inspected the vehicle. I immediately noticed it was not of the same year and body style we were looking for. The year of the truck was a 1969 Chevy pickup. The damage to the front end was not consistent as the grill was intact. There were some dents on the front of the truck; however, again, it does not appear as though it would be consistent with the damage we were looking for.

No further follow-up needs to be done. JMJost /bjc

S99 No 09059

45. IF COMPLAINANT DIFFERENT THEN CALLER, ENTER NAME, ADDRESS, D.O.B., TELEPHONE.

46. IF CODE O (OTHER) IS USED IN FIELD #39, EXPLAIN.

INCIDENT REPORT: NOTE: IF SECTION 22 ABOVE HAS NUMBER 4 CHECKED, DO NOT GO BEYOND THIS LINE WITHOUT RECORDS SECTION BEING ADVISED, OR NO RECORD ENTRIES WILL BE MADE BELOW THIS LINE.

PROPERTY VALUE	26. PROPERTY	A. CURRENCY	B. JEWELRY	C. FURS CLOTHING	D. VEHICLE (LOCAL)	E. OFFICE EQUIPMENT	F. RADIO, TV CAMERAS	G. FIREARMS	H. HOUSEHOLD GOODS
	STOLEN	\$	\$	\$	\$	\$	\$	\$	\$
	RECOVERED	\$	\$	\$	\$	\$	\$	\$	\$
	26. PROPERTY	I. CONSUMABLES	J. LIVESTOCK	K. DRUGS	L. MARINE ITEMS	M. CONSTRUCTION ITEMS	N. LAWN AND GARDEN	O. SPORTING GOODS	P. MISC BICYCLE
STOLEN	\$	\$	\$	\$	\$	\$	\$	\$	
RECOVERED	\$	\$	\$	\$	\$	\$	\$	\$	

27. PROPERTY RECOVERED: LOCALLY _____ OTHER JURISDICTION _____ (INSERT O OR L)

PROPERTY ITEMIZATION	PROPERTY STOLEN/RECOVERED ITEMIZATION, USE THE FOLLOWING FORMAT				32. CODE
	28. QUANTITY	29. ARTICLE NAME	30. BRAND NAME	31. SERIAL NUMBER	
					S R <input type="checkbox"/> <input type="checkbox"/>
					S R <input type="checkbox"/> <input type="checkbox"/>
					S R <input type="checkbox"/> <input type="checkbox"/>
					S R <input type="checkbox"/> <input type="checkbox"/>
					S R <input type="checkbox"/> <input type="checkbox"/>
					S R <input type="checkbox"/> <input type="checkbox"/>

33. PROPERTY DAMAGE AMOUNT \$ _____ 34. INSURANCE COMPANY _____

35. OFFICER ASSAULTED Y N 36. ARSON Y N 37. STRUCTURE CODE _____ 38. DAMAGE \$ _____

47. CIB	ENTERED <input type="checkbox"/>	CANCELLED <input type="checkbox"/>	48. TOTAL AMOUNT PROPERTY STOLEN \$ _____
NCIC	<input type="checkbox"/>	<input type="checkbox"/>	
OTHER BROADCAST	<input type="checkbox"/>	<input type="checkbox"/>	
			49. TOTAL AMOUNT PROPERTY RECOVERED \$ _____

50. IS REPORT CONTINUED? YES NO 51. CAUTION INDICATORS, ATLS ETC.

52. DATA PROCESS INFORMATION:

COMPUTER ENTERED DATE 11/17/99

MICROFILM INDEXED INITIAL AS

IS CASE CLASSIFICATION CORRECT? Y N

IF N HAS CORRECTION BEEN MADE? Y N

53. FILE APPROVAL

BY [Signature] DATE 11/08/99

CITY OF MANITOWOC DEPARTMENT OF POLICE OFFENSE REPORT

3. CENSUS 5 2 009	4. INCIDENT CS / 599-00242	13. DAY SUN 1 THUR 5 MON 2 FRI 6 TUES 3 SAT 7 WED 4	18. OFFICERS MTSO	NO. 929
2. CLASSIFICATION 5715	5. INCIDENT LOCATION 5.15 ST.	14. DATE 11-05-99	14. TIME 1156	
6. NAME LAST - FIRST - MI [REDACTED]	NUMBER 38774	7. D.O.B. [REDACTED]	10. PHONE-WORK [REDACTED]	21. HOW REC'D (3) PHONE 6. ON VIEW 9. OTHER 1. 911 4. TTY 7. OFF. OFF DUTY 2. POLICE RADIO 5. IN PERSON 8. C.B. RADIO
11. CITY STATE ZIP CODE [REDACTED]	9. PHONE-HOME [REDACTED]	19. REC'D BY 923	ENTERED D P BY DATE	
22. TYPE OF REPORT 1. INCIDENT 2. ACCIDENT 3. CITATION 4. NONE	23. STATUS 1. UNFOUNDED 2. PENDING 3. CLEARED 4. CLEARED BY ARREST 5. EXCEPT CLEARED	24. DATE CLEARED	25. OFFENSE TYPE 1. ADULT <input type="checkbox"/> 2. JUVENILE <input type="checkbox"/> 3. UNKNOWN <input checked="" type="checkbox"/>	

1. CASE NUMBER
99
NO
11565

39. (CODE S-SUSPECT W-WITNESS V-VICTIM O-OTHER)							
CODE	40. NAME - LAST	FIRST	MI	41. DOB	NUMBER	42. ADDRESS	43. TELEPHONE

PERSONS INVOLVED

Caller reports that the neighbor had their truck parked inside the gargage for about a year. The vehicle was always facing grill forward in the garage. The past few days the vehicle has been outside and there is noticable front damage and they are in the process of painting the Chev pick up. Vehicle may match the description of the fatal H&R vehicle involved in the MTSO investigation from Jan. 1999. The truck is parked in the back of the house on the side facing the fence. Compl. obtained a plate of BH28294/trk. 923lak

1. CASE # S99 No 09273	2. CLASSIFICATION 6.310.11	3. CENSUS 5210.00
4. INCIDENT CS / 599-00242		
5. INCIDENT LOCATION 9th and Buffalo, Manitowoc		
6. NAME- LAST-FIRST-MI Lt. Hermann, MISO	7. D.O.B.	
8. ADDRESS		9. TX-HOME
11. CITY	STATE	ZIP
10. TX-BUSINESS		
12. DETAILS Possible suspect in Hit and Run Fatal. Black GMC 4WD, Registration AK 45136		

11/10/99 1900 Hrs

14. REC'D	15. DISP	16. 10-23	17. 10-24
13. DAY			
SUN 1	MON 2	TUE 3	WED 4
	THU 5	FRI 6	SAT 7

MANITOWOC COUNTY SHERIFF INCIDENT CARD		
18. ASSIGNED Bushman		4141
R. Hermann		929 384
19. REC. BY MJB	20. DIS. BY MJB	22. TYPE OF REPORT <input checked="" type="checkbox"/> INCIDENT <input type="checkbox"/> ACCIDENT <input type="checkbox"/> CITATION <input type="checkbox"/> NONE
21. HOW REC'D. 1. 911 2. POLICE RADIO <input checked="" type="checkbox"/> 3. PHONED 4. TTY 5. IN PERSON 6. ON VIEW 7. OFF. OFF DUTY 8. C.B. RADIO 9. OTHER		23. STATUS 1. UNFOUNDED 2. RNL <input checked="" type="checkbox"/> 3. OTHER 4. CLEARED 5. EXCEPT CLEARED
24. DATE CLEARED 11/12/99		25. OFFENSE TYPE 1. ADULT <input type="checkbox"/> NA <input type="checkbox"/> 2. JUVENILE <input type="checkbox"/> 3. UNKNOWN <input type="checkbox"/>

39. (CODE S-SUSPECT W-WITNESS V-VICTIM O-OTHER)	40. NAME-LAST	FIRST	MI	41. D.O.B.	42. ADDRESS	43. TELEPHONE
O	Riebe Jason R.	181966			STH 67, Plymouth, Wi	
O	MARETTI'S DELI	40497			Buffalo St, Manitowoc	

11/10/99 @ 1900 Hrs.: Lt. R. Hermann passed along the following information reference a HOCHSTETLER hit and run suspect vehicle he observed on the streets. He phoned me, Lt. M. Bushman, at home and then left the 10-27/28 information in my drawer for follow-up. He observed a black 4-wheel drive truck parked in the area of 9th and Buffalo Sts which caught his attention because of the unusual grill design and some damage to the hood and headlight door area. The RP on this vehicle was AK45136 which lists to JASON RIEBE and WENDY SHIGUR from [REDACTED] STH 67, Plymouth. It was noted RIEBE is currently suspended and that the RP and DL information comes back from different addresses. Lt. Hermann stated the vehicle shows hood damage on the passenger side with an unusual grill and obvious replacement. He also stated a bug shield had been placed on the vehicle after the damage was sustained to the hood, and it appeared as though it was an attempt to hide the damage.

11/10/99 @ 2211 Hrs.: I, Lt. Bushman, made contact with SBSO, and a request for assistance was made. Contact was made with RIEBE at [REDACTED] STH 67 in Sheboygan Co. I advised RIEBE I was from Manitowoc and investigating a hit and run accident. I inquired about the damage to his truck and if we might take a look at it. He immediately stated his truck was currently in Manitowoc, parked across from MARETTI'S. He stated he just started working for MARETTI'S approximately 2 weeks ago. The last time the truck was driven was to his place of employment. The vehicle broke down and is currently parked on the street awaiting parts so he can return the vehicle to his residence.

I inquired about the damage to the front end. It was obvious after a short period of time that RIEBE thought I was investigating a current hit and run in which his vehicle was involved on the streets in Manitowoc. RIEBE began explaining the damage to the passenger side of his vehicle. He stated he bought the vehicle in West Bend sometime in 1996 or 1997. He could not remember who he bought the vehicle from. RIEBE stated there was damage on the vehicle in the area of the passenger side on the hood. He stated, one day before his sister's (sister named [REDACTED] graduation in the summer of 1998, he and a couple of friends were on the property of [REDACTED] STH 67 and running around in the fields behind the house. He stated they had been pulling stumps and then chasing around with the truck after that when he struck a tree. He stated the tree was on an angle, so the hood was struck and the upper portion of the headlight assembly; however, the bumper and grill was not damaged.

S99
No
57760

45. IF COMPLAINANT DIFFERENT THEN CALLER, ENTER NAME, ADDRESS, D.O.B., TELEPHONE.

46. IF CODE O (OTHER) IS USED IN FIELD #39, EXPLAIN.

INCIDENT REPORT: NOTE: IF SECTION 22 ABOVE HAS NUMBER 4 CHECKED, DO NOT GO BEYOND THIS LINE WITHOUT RECORDS SECTION BEING ADVISED, OR NO RECORD ENTRIES WILL BE MADE BELOW THIS LINE.

PROPERTY VALUE	26. PROPERTY	A. CURRENCY	B. JEWELRY	C. FURS CLOTHING	D. VEHICLE (LOCAL)	E. OFFICE EQUIPMENT	F. RADIO, TV CAMERAS	G. FIREARMS	H. HOUSE-HOLD GOODS
	STOLEN	\$	\$	\$	\$	\$	\$	\$	\$
	RECOVERED	\$	\$	\$	\$	\$	\$	\$	\$
	26. PROPERTY	I. CONSUM-ABLES	J. LIVESTOCK	K. DRUGS	L. MARINE ITEMS	M. CONSTRUCTION ITEMS	N. LAWN AND GARDEN	O. SPORTING GOODS	P. MISC BICYCLE
	STOLEN	\$	\$	\$	\$	\$	\$	\$	\$
	RECOVERED	\$	\$	\$	\$	\$	\$	\$	\$

27. PROPERTY RECOVERED: LOCALLY _____ OTHER JURISDICTION _____ (INSERT O OR L)

PROPERTY ITEMIZATION	PROPERTY STOLEN/RECOVERED ITEMIZATION, USE THE FOLLOWING FORMAT				
	28. QUANTITY	29. ARTICLE NAME	30. BRAND NAME	31. SERIAL NUMBER	
					S R <input type="checkbox"/> <input type="checkbox"/>
					S R <input type="checkbox"/> <input type="checkbox"/>
					S R <input type="checkbox"/> <input type="checkbox"/>
					S R <input type="checkbox"/> <input type="checkbox"/>

33. PROPERTY DAMAGE AMOUNT \$ _____

34. INSURANCE COMPANY _____

35. OFFICER ASSAULTED Y N

36. ARSON Y N

37. STRUCTURE CODE _____

38. DAMAGE \$ _____

47. CIB ENTERED CANCELLED
 NCIC
 OTHER BROADCAST

48. TOTAL AMOUNT PROPERTY STOLEN \$ _____

49. TOTAL AMOUNT PROPERTY RECOVERED \$ _____

50. IS REPORT CONTINUED? YES NO

51. CAUTION INDICATORS, ATLS ETC.

52. DATA PROCESS INFORMATION:

COMPUTER ENTERED DATE 11/19/99
 MICROFILM INDEXED INITIAL AS

53. FILE APPROVAL

IS CASE CLASSIFICATION CORRECT? Y N
 IF N HAS CORRECTION BEEN MADE? Y N

BY [Signature] DATE 11/22/99

MANITOWOC COUNTY SHERIFF'S DEPARTMENT
FOLLOW-UP REPORT

Page: 2

CASE NUMBER: 599-09273 CLASSIFICATION: _____

INCIDENT: _____

DATE AND TIME: _____

REPORT CONTINUED:

The bumper and grill were original from when he bought the truck. RIEBE went on to state, if there is damage to the grill and bumper, it would be new damage that currently happened while it was parked in Manitowoc.

After RIEBE described the damage, I then informed him that I was investigating a hit and run fatality in which his vehicle matched the suspect vehicle. RIEBE stated he has been to Manitowoc approximately 4 times in his life prior to becoming employed at MARETTI'S within the last 2 weeks. His truck was driven to Manitowoc for the first time when it broke down. This is why it is still sitting there.

11/11/99 @ 0120 Hrs.: I, Lt. Bushman, returned to Manitowoc and went to 9th and Buffalo Sts to view the 1983 GMC truck. The RP and VIN do match. I noted there is an after-market grill in the front; however, the chrome trim pieces on the grill are rusted in place. The grill appears as though it has been on the vehicle for quite some time. There was minor damage to the headlight door, and the hood had damage exactly as described by RIEBE from striking the tree. RIEBE stated he added the bug shield after the damage occurred. Also noted, the vehicle has very large, over-size tires and is higher than normal with a rusted lift kit noted under the truck. Nothing on the vehicle's nose appears to have been recently replaced.

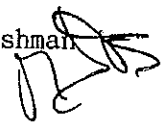
I do not believe this would be our suspect vehicle. MJBushman  /bjc

1. CASE # **S99 No 09274** 2. CLASSIFICATION **5,3|Q1** 3. CENSUS **5,2|0,0,0**

4. INCIDENT **CS/S99-00242**

5. INCIDENT LOCATION **City of Manitowoc**

6. NAME - LAST - FIRST - MI **L.E. R. Hermann** 7. D.O.B.

8. ADDRESS 9. TX-HOME

11. CITY STATE ZIP 10. TX-BUSINESS

12. DETAILS

Lt. Hermann observed a White Van with a missing grille and inquired whether or not it had been checked. FBI File indicated it was not.

13. DAY
 SUN 1 THU 5
 MON 2 FRI 6
 TUE 3 SAT 7
 WED 4

MANITOWOC COUNTY SHERIFF INCIDENT CARD

18. ASSIGNED
MISO 929
Glaeser 417
Bushman 441
R. Hermann 384

19. REC. BY **MIB** 20. DIS. BY **MIB**
 22. TYPE OF REPORT
 1. INCIDENT
 2. ACCIDENT
 3. CITATION
 4. NONE

21. HOW REC'D.
 1. 911
 2. POLICE RADIO
 3. PHONE
 4. TTY
 5. IN PERSON
 6. ON VIEW
 7. OFF. OFF DUTY
 8. C.B. RADIO
 9. OTHER

23. STATUS
 1. UNFOUNDED
 2. PNL
 3. OTHER
 4. CLEARED
 5. EXCEPT CLEARED

24. DATE CLEARED **11/17/99**
 25. OFFENSE TYPE
 1. ADULT NA
 2. JUVENILE
 3. UNKNOWN

39. (CODE S-SUSPECT W-WITNESS V-VICTIM O-OTHER)	40. NAME-LAST	FIRST	MI	41. D.O.B.	42. ADDRESS	43. TELEPHONE
0	Monka Todd M.	16761			Marshall St., Mtwc	
0	Hershberger Kirk D.	142254			23rd St., T.R.	
0	MANITOWOC HOME IMPROVEMENT	122025			Marshall St, Manitowoc	
0	VANDERBLOOMEN DALE	182062	F		CTH E, Chilton	

11/11/99 Several checks made of the residence and attempts to phone. As of this time there has been no contact. Request assistance from Afternoon shift to make and attempt. MJBushman

11/11/99 1100hrs Off. Colborn attempted contact. Monka owns Mtwc Improvements Marshall Street and lives upstairs. Unable to locate him or vehicle. Tried to locate on the job sight N.10th Street, Mtwc but was called off to a DVO complaint.

11/14/99 2130hrs Off, was advised to enter the glass door on the North side of the building and climb stairs to the apartment. Contact was made with Todd Monka. He stated he did own the white van in question, purchasing it this past summer. The van was not at the business at this time it was with an employee Kirk Hershberger in Two Rivers. Permission obtained to take a look at the vehicle. Monka claimed the damage was on the vehicle when he bought it. Address obtained from dispatch. Vehicle with registration CC91075 parked at 23rd St., Two Rivers. The entire front end had struck something some time ago. The grille was gone with parts of both headlight doors also missing. The grille was replaced with a large piece of expanded rusty metal painted over with silver paint. The frame work behind the grille was pushed in and the bumper top bowed over in the center. I could not tell if the radiator was replaced. The fan shroud was in place and not broken. The top attachment grille fastener (plastic) is broke off and still in place. That is the same attachment piece missing from the suspect vehicle parts found on scene. I would like to retrieve that pc. with the owners permission and see if it matches. (Top brachet of grille passenger side) held in place by a small screw. Tires not a direct match but probably the same size as suspect vehicle and this vehicle two wheel drive. Hood does not fit right and damage noted near both hinges on each side, may have been a replace.

May be a logical explanation for the damage, old owner needs to be tracked down and asked. M.J. Bushman

11/15/99 @ 0823 Hrs.: I, Deputy E. Glaeser, made telephone contact with TODD MONKA reference this vehicle. MONKA told me he would make an attempt to locate the name of the previous owner of the Chevy van but at this point, he did not believe he had that information available to him.

MONKA was informed of the request made by Lt. M. Bushman to check the

S99 No 0927

45. IF COMPLAINANT DIFFERENT THEN CALLER, ENTER NAME, ADDRESS, D.O.B., TELEPHONE.

46. IF CODE O (OTHER) IS USED IN FIELD #39, EXPLAIN.

INCIDENT REPORT: NOTE: IF SECTION 22 ABOVE HAS NUMBER 4 CHECKED, DO NOT GO BEYOND THIS LINE WITHOUT RECORDS SECTION BEING ADVISED, OR NO RECORD ENTRIES WILL BE MADE BELOW THIS LINE.

PROPERTY VALUE	26. PROPERTY	A. CURRENCY	B. JEWELRY	C. FURS CLOTHING	D. VEHICLE (LOCAL)	E. OFFICE EQUIPMENT	F. RADIO, TV CAMERAS	G. FIREARMS	H. HOUSE-HOLD GOODS
	STOLEN	\$	\$	\$	\$	\$	\$	\$	\$
	RECOVERED	\$	\$	\$	\$	\$	\$	\$	\$
	26. PROPERTY	I. CONSUMABLES	J. LIVESTOCK	K. DRUGS	L. MARINE ITEMS	M. CONSTRUCTION ITEMS	N. LAWN AND GARDEN	O. SPORTING GOODS	P. MISC BICYCLE
	STOLEN	\$	\$	\$	\$	\$	\$	\$	\$
	RECOVERED	\$	\$	\$	\$	\$	\$	\$	\$

27. PROPERTY RECOVERED: LOCALLY _____ OTHER JURISDICTION _____ (INSERT O OR L)

PROPERTY ITEMIZATION	PROPERTY STOLEN/RECOVERED ITEMIZATION, USE THE FOLLOWING FORMAT				
	28. QUANTITY	29. ARTICLE NAME	30. BRAND NAME	31. SERIAL NUMBER	
					S <input type="checkbox"/> R <input type="checkbox"/>
					S <input type="checkbox"/> R <input type="checkbox"/>
					S <input type="checkbox"/> R <input type="checkbox"/>
					S <input type="checkbox"/> R <input type="checkbox"/>
					S <input type="checkbox"/> R <input type="checkbox"/>

33. PROPERTY DAMAGE AMOUNT \$ _____ 34. INSURANCE COMPANY _____

35. OFFICER ASSAULTED Y N 36. ARSON Y N 37. STRUCTURE CODE _____ 38. DAMAGE \$ _____

47. CIB ENTERED CANCELLED
 NCIC
 OTHER BROADCAST

48. TOTAL AMOUNT PROPERTY STOLEN \$ _____
 49. TOTAL AMOUNT PROPERTY RECOVERED \$ _____

50. IS REPORT CONTINUED? YES NO

51. CAUTION INDICATORS, ATLS ETC.

52. DATA PROCESS INFORMATION:
 COMPUTER ENTERED DATE 11/19/99
 MICROFILM INDEXED INITIAL AS
 IS CASE CLASSIFICATION CORRECT? Y N
 IF N HAS CORRECTION BEEN MADE? Y N

53. FILE APPROVAL
 BY [Signature] DATE 11/17/99

MANITOWOC COUNTY SHERIFF'S DEPARTMENT
FOLLOW-UP REPORT

Page: 2

CASE NUMBER: 599-09274 CLASSIFICATION: _____

INCIDENT: _____

DATE AND TIME: _____

REPORT CONTINUED:

with KIRK HERSHBERGER who is presently operating the vehicle as a representative for MANITOWOC HOME IMPROVEMENT. MONKA told me, however, HERSHBERGER was working on a priority job north of Bonduel and may be outside the Manitowoc area for the better part of today's date. MONKA did, however, give MTSO permission to remove the suspect grill pieces as needed in this investigation. He was further informed, if there were any pieces removed from the grill, HERSHBERGER would be given a receipt for those items. I verified HERSHBERGER'S address in Two Rivers with MONKA.

I further asked him if he had any information in regard to who the former owner may have been. MONKA told me his company was doing a construction/remodeling job on CTH E, east of Stockbridge, this summer when they purchased the Chevy van from a private party. The only information MONKA could provide on that party was that this particular residence is approximately 0.5 mile east of [REDACTED] CTH E, east of Stockbridge. MONKA told me the residence could be described as having a long driveway and a house and barn with the yard area being overgrown and in need of repair. MONKA told me he could remember when he purchased the vehicle from this party, they told him the van used to belong to his father, but they offered no explanation for the damages.

MONKA told me he would attempt to contact one of his maintenance workers and that there was a possibility that he may have the owner information in his records from that particular job.

11/15/99 @ 0836 Hrs.: I, Deputy Glaeser, made contact with CASO Capt. Paul Rusch reference this incident. He was asked if he could offer assistance in making a determination on the identity of a party described by MONKA as being the one sold who sold him this vehicle. Capt. Rusch was very cooperative. He told me he would send one of his patrolmen out to this particular area and make a determination on the identity of the parties who live there.

11/15/99 @ 0920 Hrs.: I received a call back from Capt. Rusch. He provided information to me on the resident of the property in question.

11/15/99 @ 0921 Hrs.: Capt. Rusch told me the residence had been checked. It was CASO's belief that the property was occupied by DALE VANDERBLOOMEN, address was [REDACTED] CTH E, phone was [REDACTED]. According to CASO records, VANDERBLOOMEN moved in this residence somewhere after 12/01/97 and he was presently residing at this residence. Capt. Rusch also relayed police contacts with VANDERBLOOMEN have been very limited.

11/15/99 @ 1125 Hrs.: I attempted telephone contact with VANDERBLOOMEN reference this incident. I was only able to reach his answering machine. A message was left for VANDERBLOOMEN to contact me at MTSO.

11/15/99 @ 1135 Hrs.: I again attempted contact with MONKA reference confirmation from his maintenance man on the identity of the vehicle owner. I was informed MONKA was currently in a business meeting. A message was left for MONKA to call me at MTSO.

MANITOWOC COUNTY SHERIFF'S DEPARTMENT
FOLLOW-UP REPORT

Page: 3

CASE NUMBER: 599-09274 CLASSIFICATION: _____

INCIDENT: _____

DATE AND TIME: _____

REPORT CONTINUED:

This information will be relayed to Lt. Bushman. Pending further follow-up.
EJGlaeser /bjc

O HERMSEN LLOYD Kimberly [REDACTED]--OR--[REDACTED]
O KLARNER NORMAN J [REDACTED] [REDACTED] Peters Rd, Kaukauna [REDACTED]

11/15/99 @ 1805 Hrs.: I, Lt. M. Bushman, made contact with DALE VANDERBLOOMEN by phone. I questioned him about the white van. He stated he did sell it from his yard in the beginning of summer and then retrieved a card from the buyer which had a business of MANITOWOC HOME IMPROVEMENT. VANDERBLOOMEN stated he traded a hay bine to LLOYD HERMSEN in February 1999 for the van. The van had a cracked windshield, a home-made grill, and some damage to the headlight doors and bumper. He stated he never registered the vehicle and did not have it very long. It sat in his back yard. He eventually placed it in the front when it was sold.

11/15/99 @ 1815 Hrs.: Contact was made with LLOYD HERMSEN by phone in Kimberly. HERMSEN stated he bought this vehicle because the price was right and he only put approximately 300 miles on it. The bumper had been pushed in, and the grill was completely gone. HERMSEN stated he obtained a piece of expanded metal, painted it silver, and cut it to fit in place of the grill because the vehicle "looked like hell" without the grill in the front. He stated he purchased the grill from a retired gentleman by the name of NORMAN KLARNER of Kaukauna. He stated he obtained the vehicle from KLARNER in October 1998, he believes. The damage was already on the vehicle.

11/15/99 @ 1830 Hrs.: Contact was made with NORMAN KLARNER at his residence in Kaukauna. He stated he did own the white van and sold it to LLOYD HERMSEN. Sometime in either the fall or spring 1997, while there was snow and ice on the road, he was involved in an accident in Grand Chute at the intersection of USH 41 and College Ave. He stated he slid on the ice and rear-ended another car. There should be an accident report on file with Grand Chute PD. He stated he sold the vehicle with the damage to the bumper, cracked windshield, and grill completely gone to HERMSEN. He stated he observed this vehicle after it was sold. HERMSEN placed a piece of expanded metal in the grill work.

11/15/99 @ 1840 Hrs.: Contact was made with TODD MONKA from MANITOWOC HOME IMPROVEMENTS who is the current owner of the vehicle. He has been very cooperative with the investigation. He was thanked for his cooperation. I stated I would not be bothering him any time in the future as I found out where the damage took place.

This would not be the vehicle that we are interested in finding. MJBushman /bjc

1. CASE # S99 No 09828
 2. CLASSIFICATION 6310.11
 3. CENSUS 70000

4. INCIDENT CS/599-00242
 5. INCIDENT LOCATION Kewaunee
 6. NAME - LAST - FIRST - MI Anonymous
 7. D.O.B.
 8. ADDRESS
 9. TX-HOME
 10. TX-BUSINESS
 11. CITY STATE ZIP
 12. DETAILS See attached

2105
 11/29/99
 REC'D 14. DISP 15. 10-23 16. 10-24 17.
 13. DAY
 SUN 1 THU 5
 MON 2 FRI 6
 TUE 3 SAT 7
 WED 4

MANITOWOC COUNTY SHERIFF
 INCIDENT CARD

18. ASSIGNED MJSO 9129
 Lt Bushman 4141

19. REC. BY 435
 20. DIS. BY
 21. HOW REC'D.
 1. 911
 2. POLICE RADIO
 3. PHONE
 4. TTY
 5. IN PERSON
 6. ON VIEW
 7. OFF. OFF DUTY
 8. C.B. RADIO
 9. OTHER
 21A. M.O.

22. TYPE OF REPORT
 1. INCIDENT
 2. ACCIDENT
 3. CITATION
 4. NONE
 23. STATUS
 1. UNFOUNDED
 2. PNL
 3. OTHER
 4. CLEARED
 5. EXCEPT CLEARED
 24. DATE CLEARED 11/20/99
 25. OFFENSE TYPE
 1. ADULT NA
 2. JUVENILE
 3. UNKNOWN

39. (CODE S-SUSPECT W-WITNESS V-VICTIM O-OTHER)						
CODE	40. NAME-LAST	FIRST	MI	41. D.O.B.	42. ADDRESS	43. TELEPHONE
0	[REDACTED]	114022	[REDACTED]	[REDACTED]	[REDACTED]	[REDACTED]

11/29/99 @ 2105 Hrs.: I, Lt. M. Bushman, was contacted by Dispatch who had a caller on the line wishing to report a Crime Stopper on a possible suspect vehicle to the hit and run fatality. The phone call was forwarded to the Shift Commanders' Office, and I spoke with [REDACTED] from Kewaunee Co.

[REDACTED] stated he bought a vehicle from MOTOR SPORTS in mid-February with the passenger side grill damaged. He just saw the incident on the fatal on TV and would like to have an officer check his vehicle. He stated his vehicle is currently painted black; however, it was brown at one time. He did not know who the prior owner was as the vehicle was on consignment to MOTOR SPORTS in Green Bay. The passenger side door (slider) has had some bondo mix on it as it is currently causing the paint to chip. He also stated the right/passenger headlight assembly is broken with some pieces missing. He is unaware of whether the vehicle had been repaired prior to him purchasing the vehicle.

Arrangements were made for me to look at the vehicle which would be parked outside in the settlement of Norman in Kewaunee Co. Directions were given to his residence which is on the SW corner of CTH G in Norman.

11/30/99 @ 0030 Hrs.: I observed the black Chevrolet van with RP UKA908 listing on a 1983 Chevrolet truck to [REDACTED]. There was some minor damage to the headlight assembly on the passenger side. The grill, bumper, and hood did not appear to have been replaced.

I had access to the vehicle and popped the hood. There was no indication behind the exterior grill that the wall holding the radiator had been damaged. All the parts underneath the vehicle and inside the hood area appeared to be original as the rust was consistent throughout all parts attached to the front end. It did not appear any of the parts had been changed, and all showed an equal amount of wear. None of the screw or bolt heads under the vehicle or under the hood appeared to have been turned recently.

I do not believe this is our suspect vehicle. MJBushman /bjc

S99 No 09828

45. IF COMPLAINANT DIFFERENT THEN CALLER, ENTER NAME, ADDRESS, D.O.B., TELEPHONE.

46. IF CODE O (OTHER) IS USED IN FIELD #39, EXPLAIN.

INCIDENT REPORT: NOTE: IF SECTION 22 ABOVE HAS NUMBER 4 CHECKED, DO NOT GO BEYOND THIS LINE WITHOUT RECORDS SECTION BEING ADVISED, OR NO RECORD ENTRIES WILL BE MADE BELOW THIS LINE.

PROPERTY VALU E	26. PROPERTY	A. CURRENCY	B. JEWELRY	C. FURS CLOTHING	D. VEHICLE (LOCAL)	E. OFFICE EQUIPMENT	F. RADIO, TV CAMERAS	G. FIREARMS	H. HOUSE-HOLD GOODS
	STOLEN	\$	\$	\$	\$	\$	\$	\$	\$
	RECOVERED	\$	\$	\$	\$	\$	\$	\$	\$
	26. PROPERTY	I. CONSUM-ABLES	J. LIVESTOCK	K. DRUGS	L. MARINE ITEMS	M. CONSTRUCTION ITEMS	N. LAWN AND GARDEN	O. SPORTING GOODS	P. MISC BICYCLE
	STOLEN	\$	\$	\$	\$	\$	\$	\$	\$
	RECOVERED	\$	\$	\$	\$	\$	\$	\$	\$

27. PROPERTY RECOVERED: LOCALLY _____ OTHER JURISDICTION _____ (INSERT O OR L)

PROPERTY ITEMI ZATI ON	PROPERTY STOLEN/RECOVERED ITEMIZATION, USE THE FOLLOWING FORMAT				
	28. QUANTITY	29. ARTICLE NAME	30. BRAND NAME	31. SERIAL NUMBER	32. CODE
					S R <input type="checkbox"/> <input type="checkbox"/>
					S R <input type="checkbox"/> <input type="checkbox"/>
					S R <input type="checkbox"/> <input type="checkbox"/>
					S R <input type="checkbox"/> <input type="checkbox"/>

33. PROPERTY DAMAGE AMOUNT \$ _____

34. INSURANCE COMPANY _____

35. OFFICER ASSAULTED Y N

36. ARSON Y N

37. STRUCTURE CODE _____

38. DAMAGE \$ _____

47. CIB ENTERED CANCELLED
 NCIC
 OTHER BROADCAST

48. TOTAL AMOUNT PROPERTY STOLEN \$ _____

49. TOTAL AMOUNT PROPERTY RECOVERED \$ _____

50. IS REPORT CONTINUED? YES NO

51. CAUTION INDICATORS, ATLS ETC.

52. DATA PROCESS INFORMATION:

COMPUTER ENTERED DATE 1/23/99

MICROFILM INDEXED INITIAL KS

IS CASE CLASSIFICATION CORRECT? N
 IF N HAS CORRECTION BEEN MADE? N

53. FILE APPROVAL

BY *K*

DATE 1/20/99

1. CASE # S99 No 09851 | 2. CLASSIFICATION 10301 | 3. CENSUS 701000

4. INCIDENT CS / 399-00242

5. INCIDENT LOCATION

6. NAME - LAST - FIRST - MI anon (2) | 7. D.O.B.

8. ADDRESS | 9. TX-HOME

11. CITY STATE ZIP | 10. TX-BUSINESS

12. DETAILS
 Complainant states approx a year ago a male subject known to him as Joe Fish has a red white dodge with front end damage. He is on America's Most Wanted and lives in Milwaukee. He was given a CS number.

11-30-99 2210

14. REC'D	15. DISP	16. 10-23	17. 10-24
13. DAY			
SUN 1	THU 5		
MON 2	FRI 6		
TUE 3	SAT 7		
WED 4			

MANITOWOC COUNTY SHERIFF
INCIDENT CARD

18. ASSIGNED 400
9129

19. REC. BY 928	20. DIS. BY	22. TYPE OF REPORT
		① INCIDENT 2. ACCIDENT 3. CITATION 4. NONE
21. HOW REC'D.		23. STATUS
1. 911 2. POLICE RADIO ③ PHONE 4. TTY 5. IN PERSON 6. ON VIEW 7. OFF. OFF DUTY 8. C.B. RADIO 9. OTHER		1. UNFOUNDED 2. PNL ③ OTHER 4. CLEARED 5. EXCEPT CLEARED
21A. M.O.		24. DATE CLEARED 11/20/99
		25. OFFENSE TYPE
		1. ADULT <input type="checkbox"/> NA <input checked="" type="checkbox"/> 2. JUVENILE <input type="checkbox"/> 3. UNKNOWN <input type="checkbox"/>

39. (CODE S-SUSPECT W-WITNESS V-VICTIM O-OTHER)				42. ADDRESS		43. TELEPHONE
CODE	40. NAME - LAST	FIRST	MI	41. D.O.B.		

45. IF COMPLAINANT DIFFERENT THEN CALLER, ENTER NAME, ADDRESS, D.O.B., TELEPHONE.

46. IF CODE O (OTHER) IS USED IN FIELD #39, EXPLAIN.

INCIDENT REPORT: NOTE: IF SECTION 22 ABOVE HAS NUMBER 4 CHECKED, DO NOT GO BEYOND THIS LINE WITHOUT RECORDS SECTION BEING ADVISED, OR NO RECORD ENTRIES WILL BE MADE BELOW THIS LINE.

PROPERTY VALUE	26. PROPERTY	A. CURRENCY	B. JEWELRY	C. FURS CLOTHING	D. VEHICLE (LOCAL)	E. OFFICE EQUIPMENT	F. RADIO, TV CAMERAS	G. FIREARMS	H. HOUSE-HOLD GOODS
	STOLEN	\$	\$	\$	\$	\$	\$	\$	\$
	RECOVERED	\$	\$	\$	\$	\$	\$	\$	\$
	26. PROPERTY	I. CONSUMABLES	J. LIVESTOCK	K. DRUGS	L. MARINE ITEMS	M. CONSTRUCTION ITEMS	N. LAWN AND GARDEN	O. SPORTING GOODS	P. MISC BICYCLE
	STOLEN	\$	\$	\$	\$	\$	\$	\$	\$
	RECOVERED	\$	\$	\$	\$	\$	\$	\$	\$

27. PROPERTY RECOVERED: LOCALLY _____ OTHER JURISDICTION _____ (INSERT O OR L)

PROPERTY ITEMIZATION	PROPERTY STOLEN/RECOVERED ITEMIZATION, USE THE FOLLOWING FORMAT				
	28. QUANTITY	29. ARTICLE NAME	30. BRAND NAME	31. SERIAL NUMBER	32. CODE
					S <input type="checkbox"/> R <input type="checkbox"/>
					S <input type="checkbox"/> R <input type="checkbox"/>
					S <input type="checkbox"/> R <input type="checkbox"/>
					S <input type="checkbox"/> R <input type="checkbox"/>
					S <input type="checkbox"/> R <input type="checkbox"/>

33. PROPERTY DAMAGE AMOUNT \$ _____

34. INSURANCE COMPANY _____

35. OFFICER ASSAULTED Y N

36. ARSON Y N

37. STRUCTURE CODE _____

38. DAMAGE \$ _____

47. CIB ENTERED CANCELLED
 NCIC
 OTHER BROADCAST

48. TOTAL AMOUNT PROPERTY STOLEN \$ _____

49. TOTAL AMOUNT PROPERTY RECOVERED \$ _____

50. IS REPORT CONTINUED? YES NO

51. CAUTION INDICATORS, ATLS ETC.

52. DATA PROCESS INFORMATION:

COMPUTER ENTERED DATE 12.3.99
 MICROFILM INDEXED INITIAL KS

53. FILE APPROVAL

IS CASE CLASSIFICATION CORRECT? Y N
 IF N HAS CORRECTION BEEN MADE? Y N

BY _____ DATE

1. CASE # S99 No 08921 2. CLASSIFICATION 6310.11 3. CENSUS 701000

4. INCIDENT CS/S99-00242

5. INCIDENT LOCATION

6. NAME - LAST - FIRST - MI GBPD (1040) 7. D.O.B.

8. ADDRESS 9. TX-HOME

11. CITY STATE ZIP 10. TX-BUSINESS

12. DETAILS
 FAX CAME FOR SUSP. VEH. POSSIBLY
 BEING PARKED IN CRIVITZ AT
 MARV'S AUTO.

11-01-99 1304

MANITOWOC COUNTY SHERIFF
INCIDENT CARD

18. ASSIGNED C.S. MTSO 929

BUSHMAN 4411

19. REC. BY 20. DIS. BY 22. TYPE OF REPORT

923
 1. INCIDENT
 2. ACCIDENT
 3. CITATION
 4. NONE

21. HOW REC'D.
 1. 911
 2. POLICE RADIO
 3. PHONE
 4. TTY
 5. IN PERSON
 6. ON VIEW
 7. OFF. OFF DUTY
 8. C.B. RADIO
 9. OTHER FAX
 21A. M.O.

23. STATUS
 1. UNFOUNDED
 2. PNL
 3. OTHER
 4. CLEARED
 5. EXCEPT CLEARED

24. DATE CLEARED 11/10/99
 25. OFFENSE TYPE
 1. ADULT NA
 2. JUVENILE
 3. UNKNOWN

14. REC'D 15. DISP 16. 10-23 17. 10-24
 13. DAY
 SUN 1 THU 6
 MON 2 FRI 6
 TUE 3 SAT 7
 WED 4

39. (CODE S-SUSPECT W-WITNESS V-VICTIM O-OTHER)						
CODE	40. NAME-LAST	FIRST	MI	41. D.O.B.	42. ADDRESS	43. TELEPHONE

11/02/99 2130rhrs Contact made by phone with Marinette Co. SO and request to have Officer swing by Marv's made and while there call MTSO so specifics on damage can be relayed. Request was forwarded to Crivitz Officer. M.J. Bushman

11/02/99 @ 2215 Hrs.: I, Lt. M. Bushman, received a phone call back from Officer Brian Witt of Crivitz PD. He located the Chevrolet Suburban at MARV'S AUTO SALES in Crivitz and was calling for further details. There is no RP on the vehicle, but the VIN was [REDACTED] which lists on a 1986 Chevrolet truck to CLINE DENTAL LABORATORY INC. from Waukesha. A 10-28 is attached to this complaint.

Officer Witt looked the vehicle over very closely. There is no damage other than on the passenger side mirror which has the glass broken out. The 1986 Chevrolet Suburban is 2-tone colored black and silver with running boards on the side and a bug shield. It has 2 square headlights in the front, one underneath the other. When he looked for damage underneath, he noted all the grill parts, radiator, fender, and hood looked to be original as there was old rust and the grill was quite brittle. It does not appear as though this vehicle had been fixed in the recent past and has no damage consistent to that in the hit and run accident.

This would not be our suspect vehicle. MJBushman /bjc

S99 No 08921

45. IF COMPLAINANT DIFFERENT THEN CALLER, ENTER NAME, ADDRESS, D.O.B., TELEPHONE.

46. IF CODE O (OTHER) IS USED IN FIELD #39, EXPLAIN.

INCIDENT REPORT: NOTE: IF SECTION 22 ABOVE HAS NUMBER 4 CHECKED, DO NOT GO BEYOND THIS LINE WITHOUT RECORDS SECTION BEING ADVISED, OR NO RECORD ENTRIES WILL BE MADE BELOW THIS LINE.

PROPERTY VALUE	26. PROPERTY	A. CURRENCY	B. JEWELRY	C. FURS CLOTHING	D. VEHICLE (LOCAL)	E. OFFICE EQUIPMENT	F. RADIO, TV CAMERAS	G. FIREARMS	H. HOUSE-HOLD GOODS
	STOLEN	\$	\$	\$	\$	\$	\$	\$	\$
	RECOVERED	\$	\$	\$	\$	\$	\$	\$	\$
	26. PROPERTY	I. CONSUMABLES	J. LIVESTOCK	K. DRUGS	L. MARINE ITEMS	M. CONSTRUCTION ITEMS	N. LAWN AND GARDEN	O. SPORTING GOODS	P. MISC BICYCLE
STOLEN	\$	\$	\$	\$	\$	\$	\$	\$	
RECOVERED	\$	\$	\$	\$	\$	\$	\$	\$	

27. PROPERTY RECOVERED: LOCALLY _____ OTHER JURISDICTION _____ (INSERT O OR L)

PROPERTY ITEMIZATION	PROPERTY STOLEN/RECOVERED ITEMIZATION, USE THE FOLLOWING FORMAT				
	28. QUANTITY	29. ARTICLE NAME	30. BRAND NAME	31. SERIAL NUMBER	32. CODE
					S <input type="checkbox"/> R <input type="checkbox"/>
					S <input type="checkbox"/> R <input type="checkbox"/>
					S <input type="checkbox"/> R <input type="checkbox"/>
					S <input type="checkbox"/> R <input type="checkbox"/>

33. PROPERTY DAMAGE AMOUNT \$ _____ 34. INSURANCE COMPANY _____

35. OFFICER ASSAULTED Y N 36. ARSON Y N 37. STRUCTURE CODE _____ 38. DAMAGE \$ _____

47. CIB <input type="checkbox"/>	ENTERED <input type="checkbox"/>	CANCELLED <input type="checkbox"/>	48. TOTAL AMOUNT PROPERTY STOLEN \$ _____
NCIC <input type="checkbox"/>	<input type="checkbox"/>	<input type="checkbox"/>	
OTHER BROADCAST <input type="checkbox"/>	<input type="checkbox"/>	<input type="checkbox"/>	
			49. TOTAL AMOUNT PROPERTY RECOVERED \$ _____

50. IS REPORT CONTINUED? YES NO 51. CAUTION INDICATORS, ATLS ETC.

52. DATA PROCESS INFORMATION:

COMPUTER ENTERED DATE

MICROFILM INDEXED INITIAL _____

IS CASE CLASSIFICATION CORRECT? Y N
IF N HAS CORRECTION BEEN MADE? Y N

53. FILE APPROVAL
BY PK DATE 1/11/04 991

1. CASE # S99 No 08941 2. CLASSIFICATION 6310.11 3. CENSUS 7,010,000

4. INCIDENT C.S. /599-00242

5. INCIDENT LOCATION Clintonville, Wi

6. NAME - LAST - FIRST - MI [REDACTED] 7. D.O.B. [REDACTED]

8. ADDRESS [REDACTED] 9. TX-HOME [REDACTED]

11. CITY [REDACTED] STATE [REDACTED] ZIP [REDACTED] 10. TX-BUSINESS [REDACTED]

12. DETAILS
Saw a truck today that may have been involved in the Hochstetler H+R. (146034)

11-1-99 2210

MANITOWOC COUNTY SHERIFF INCIDENT CARD

18. ASSIGNED Lt. Bushman 441

19. REC. BY 941 20. DIS. BY [REDACTED] 22. TYPE OF REPORT 1. INCIDENT 2. ACCIDENT 3. CITATION 4. NONE

21. HOW REC'D. 1. 911 2. POLICE RADIO 3. PHONE 4. TTY 5. IN PERSON 6. ON VIEW 7. OFF. OFF DUTY 8. C.B. RADIO 9. OTHER 23. STATUS 1. UNFOUNDED 2. PNL 3. OTHER 4. CLEARED 5. EXCEPT CLEARED

14. REC'D	15. DISP	16. 10-23	17. 10-24
13. DAY			
SUN 1	THU 5		
MON 2	FRI 6		
TUE 3	SAT 7		
WED 4			

24. DATE CLEARED 11/04/99 25. OFFENSE TYPE 1. ADULT NA 2. JUVENILE 3. UNKNOWN

39. (CODE S-SUSPECT W-WITNESS V-VICTIM O-OTHER)	40. NAME-LAST	FIRST	MI	41. D.O.B.	42. ADDRESS	43. TELEPHONE

11/02/99 2135hrs Contact attempted by phone, answering machine message was left with my hours and request for a call back later this evening or 11/03/99. M.J. Bushman

11/02/99 @ 2245 Hrs.: The complainant, [REDACTED], called me, Lt. M. Bushman, back in response to the message left on his answering machine. [REDACTED] stated he again saw the vehicle in Clintonville today at FLEET FARM. He did not get an RP on the vehicle. He does believe this vehicle is a local resident of Clintonville and possibly lives on the high school side of town.

The vehicle was described as a 4-door Suburban, gray and tan in color. The vehicle's grill has damage to the center and corners with some pieces missing. The bumper also has damage with a dent in front of the driver side. It has square headlamps, and it appears as though the headlamps are all very new. The driver of the vehicle is estimated to be 40 years old with a beard, medium build, beer belly, and receding hairline. [REDACTED] stated this is the second time he saw this vehicle in a week and he will keep watching for it. Hopefully, he will be able to obtain an RP.

11/03/99 @ 0158 Hrs.: Contact was made by phone with Clintonville PD Dispatch, first name KAREN. She was advised of this complaint and given a description of the driver and vehicle. It was requested that Clintonville PD take a look at both the driver and vehicle and see if this fits any residents in the village and to keep an eye out for this vehicle traveling in their jurisdiction. Per her request, I did fax her a copy of a cover sheet I made up earlier with a description of the accident, the vehicle, and the type of damage we would be looking for, their fax [REDACTED].

Awaiting response. MJBushman /bjc

CASE # S99 No 08941

45. IF COMPLAINANT DIFFERENT THEN CALLER, ENTER NAME, ADDRESS, D.O.B., TELEPHONE.

46. IF CODE O (OTHER) IS USED IN FIELD #39, EXPLAIN.

INCIDENT REPORT: NOTE: IF SECTION 22 ABOVE HAS NUMBER 4 CHECKED, DO NOT GO BEYOND THIS LINE WITHOUT RECORDS SECTION BEING ADVISED, OR NO RECORD ENTRIES WILL BE MADE BELOW THIS LINE.

PROPERTY VALUE	26. PROPERTY	A. CURRENCY	B. JEWELRY	C. FURS CLOTHING	D. VEHICLE (LOCAL)	E. OFFICE EQUIPMENT	F. RADIO, TV CAMERAS	G. FIREARMS	H. HOUSEHOLD GOODS
	STOLEN	\$	\$	\$	\$	\$	\$	\$	\$
	RECOVERED	\$	\$	\$	\$	\$	\$	\$	\$
	26. PROPERTY	I. CONSUMABLES	J. LIVESTOCK	K. DRUGS	L. MARINE ITEMS	M. CONSTRUCTION ITEMS	N. LAWN AND GARDEN	O. SPORTING GOODS	P. MISC BICYCLE
STOLEN	\$	\$	\$	\$	\$	\$	\$	\$	
RECOVERED	\$	\$	\$	\$	\$	\$	\$	\$	

27. PROPERTY RECOVERED: LOCALLY _____ OTHER JURISDICTION _____ (INSERT O OR L)

PROPERTY ITEMIZATION	PROPERTY STOLEN/RECOVERED ITEMIZATION, USE THE FOLLOWING FORMAT				
	28. QUANTITY	29. ARTICLE NAME	30. BRAND NAME	31. SERIAL NUMBER	32. CODE
					S R <input type="checkbox"/> <input type="checkbox"/>
					S R <input type="checkbox"/> <input type="checkbox"/>
					S R <input type="checkbox"/> <input type="checkbox"/>
					S R <input type="checkbox"/> <input type="checkbox"/>
					S R <input type="checkbox"/> <input type="checkbox"/>

33. PROPERTY DAMAGE AMOUNT \$ _____

34. INSURANCE COMPANY _____

35. OFFICER ASSAULTED Y N

36. ARSON Y N

37. STRUCTURE CODE _____

38. DAMAGE \$ _____

47. CIB ENTERED CANCELLED
 NCIC
 OTHER BROADCAST

48. TOTAL AMOUNT PROPERTY STOLEN \$ _____

49. TOTAL AMOUNT PROPERTY RECOVERED \$ _____

50. IS REPORT CONTINUED? YES NO

51. CAUTION INDICATORS, ATLS ETC.

52. DATA PROCESS INFORMATION:

COMPUTER ENTERED DATE 11.4.99

MICROFILM INDEXED INITIAL KS

IS CASE CLASSIFICATION CORRECT? N
 IF N HAS CORRECTION BEEN MADE? N

53. FILE APPROVAL

BY 

DATE 11.04.99

1. CASE # S99 No 02492		2. CLASSIFICATION 6,310,11		3. CENSUS 7,010,00	
4. INCIDENT CS/S99-00242					
5. INCIDENT LOCATION CITY OF GREEN BAY.					
6. NAME - LAST - FIRST - MI GBPD.				7. D.O.B.	
8. ADDRESS			9. TX-HOME		
11. CITY		STATE	ZIP	10. TX-BUSINESS	
12. DETAILS GBPD REC'D CRIMESTOPPER REPORT OF CHEV SUBURBAN, WI RP MND-654 PARLED IN THEIR CITY ON 3-29-99 THAT MATCHES SUSPECT VEH FROM H&R.					

MANITOWOC COUNTY SHERIFF INCIDENT CARD					
18. ASSIGNED MISO				91219	
19. REC. BY 932		20. DIS. BY		22. TYPE OF REPORT	
21. HOW REC'D.		23. STATUS		24. DATE CLEARED	
1. 911		1. UNFOUNDED		25. OFFENSE TYPE	
2. POLICE RADIO		2. PNL		1. ADULT <input type="checkbox"/> NA <input type="checkbox"/>	
3. PHONE		3. OTHER		2. JUVENILE <input type="checkbox"/>	
4. TTY		4. CLEARED		3. UNKNOWN <input type="checkbox"/>	
5. IN PERSON		5. EXCEPT CLEARED			
6. ON VIEW					
7. OFF. OFF DUTY					
8. C.B. RADIO					
9. OTHER FAX					
21A. M.O.					

14. REC'D	15. DISP	16. 10-23	17. 10-24
13. DAY			
SUN 1	THU 5		
MON 2	FRI 6		
TUE 3	SAT 7		
WED 4			

39. (CODE S-SUSPECT W-WITNESS V-VICTIM O-OTHER)				42. ADDRESS		43. TELEPHONE	
CODE	40. NAME-LAST	FIRST	MI	41. D.O.B.			

Manitowoc County SO is investigating a Fatal Hit & Run Accident from 01/10/99 0225hrs on: CIH CR South of the City of Manitowoc. CIH CR is roadbed from the Old 141 highway and is currently a frontage road for I-43. Suspect vehicle struck a 17 year old young man walking South on the West shoulder. Victim was then dragged 300 Ft. down the roadway and left to die. Victim was 6'1 210 pounds.

Suspect vehicle is a 1985-1987 (some very early 1988) Chevrolet Pickup, Suburban, K-5 (full size) Blazer or 1989-1991 Chev van. Damage will be extensive to the grill some hood and possibly bumper. There were parts from the engine fan shroud at the scene indicating the radiator support wall was pushed backward turning the shroud into the fan. The radiator did not leak. Damage concentration would be just to the left of center (if facing vehicle front) between the Chevrolet emblem and passenger side headlamp. No glass or lens material found at scene. There may be windshield damage. Vehicle is a low line Chev product, like a Custom Deluxe or Scotsdale version, single rectangular semi round headlamp at each side of grill. Vehicle should be standard height, no lift kit, tires 7/8 inch wide non aggressive thread, your basic Fleet Farm special.

Request your assistance in checking the above listed vehicle in your area, call MISO and speak with Lt. Michael J. Bushman for further detail. () M.J. Bushman

CASE #
S99
No 02492

1. CASE # S99 No 08952 2. CLASSIFICATION 6.30.11 3. CENSUS 70000
 4. INCIDENT crime stopper 599-0024
 5. INCIDENT LOCATION
 6. NAME - LAST - FIRST - MI Appleton PD 15037 7. D.O.B.
 8. ADDRESS 9. TX-HOME
 11. CITY STATE ZIP 10. TX-BUSINESS
 12. DETAILS rec'd fax info re: possible suspect veh

1032
 11/2/99
 14. REC'D. 15. DISP 16. 10-23 17. 10-24
 13. DAY
 SUN 1 THU 5
 MON 2 FRI 6
 TUE 3 SAT 7
 WED 4

MANITOWOC COUNTY SHERIFF
 INCIDENT CARD
 18. ASSIGNED Bushman 4411
 MTSO 929
 19. REC. BY 921 20. DIS. BY
 22. TYPE OF REPORT
 1. INCIDENT
 2. ACCIDENT
 3. CITATION
 4. NONE
 21. HOW REC'D.
 1. 911
 2. POLICE RADIO
 3. PHONE
 4. TTY
 5. IN PERSON
 6. ON VIEW
 7. OFF. OFF DUTY
 8. C.B. RADIO
 9. OTHER
 23. STATUS
 1. UNFOUNDED
 2. PNL
 3. OTHER
 4. CLEARED
 5. EXCEPT CLEARED
 24. DATE CLEARED 11/10/99
 25. OFFENSE TYPE
 1. ADULT NA
 2. JUVENILE
 3. UNKNOWN

39. (CODE S-SUSPECT W-WITNESS V-VICTIM O-OTHER)	40. NAME-LAST	FIRST	MI	41. D.O.B.	42. ADDRESS	43. TELEPHONE
O	MILLS	JERRY				
O	HEIMERL	ERIC	A		Tonya Trl, Neenah 54956	

11/03/99 @ 0215 Hrs.: MTSO received a fax from Appleton PD on 11/02/99. The fax was a Crime Stoppers tip which was received on 10/29/99 at 1230 hours. The caller reported seeing an item on the news about a woman whose son was run over on the side of the road. The caller thinks this may have happened in Manitowoc Co. The caller reported seeing a vehicle of that description at DAN'S QUICK MART in Appleton on Friday. The caller was not sure if this was the right vehicle, but the grill was busted out at about the same position that he saw on TV. The RP was C over AD and then followed with 33-254. He stated it was a brown Silverado truck with a white ban half way down the door. The complaint is JERRY MILLS whose home number is () and work number is (). No other information was obtained from Appleton PD as far as DOB and address.

Dispatch was requested to try several variations of the RP--CA33254, CD33254, and AD33254. The only RP which came back currently issued is CD33254 on a 1975 Chevrolet truck which lists to ERIC HEIMERL.

Contact was made with Neenah PD Dispatch, and they were given the information about ERIC HEIMERL and the 1975 Chevy. They stated the vehicle would actually be located in the Town of Menasha and did forward the information to Menasha PD.

Approximately 15 minutes later, a Menasha PD officer did call me at MTSO. The vehicle was located at Tonya Trl, Neenah. It was described as "a piece of junk." It was brown and white in color. The front end had round headlights on each side. The grill had some minor pieces missing near the hood latch, and there was a white buff mark on the bumper. The RP was bent slightly. The officer viewed the rest of the front grill work and hood. He reported no damage anywhere else that would be consistent with the HOCHSTETLER incident, and it appears all of the parts, hood, grill, radiator, and bumper have not been replaced and would be aged similar to the rest of the vehicle.

There were numerous inconsistencies with the way the vehicle looks and would not be considered a suspect vehicle in the HOCHSTETLER accident. This complaint can be closed.
 MJBushman /bjc

S99 No 08952

11/10/99

45. IF COMPLAINANT DIFFERENT THEN CALLER, ENTER NAME, ADDRESS, D.O.B., TELEPHONE.

46. IF CODE O (OTHER) IS USED IN FIELD #39, EXPLAIN.

INCIDENT REPORT: NOTE: IF SECTION 22 ABOVE HAS NUMBER 4 CHECKED, DO NOT GO BEYOND THIS LINE WITHOUT RECORDS SECTION BEING ADVISED, OR NO RECORD ENTRIES WILL BE MADE BELOW THIS LINE.

PROPERTY VALUE	26. PROPERTY	A. CURRENCY	B. JEWELRY	C. FURS CLOTHING	D. VEHICLE (LOCAL)	E. OFFICE EQUIPMENT	F. RADIO, TV CAMERAS	G. FIREARMS	H. HOUSE-HOLD GOODS
	STOLEN	\$	\$	\$	\$	\$	\$	\$	\$
	RECOVERED	\$	\$	\$	\$	\$	\$	\$	\$
	26. PROPERTY	I. CONSUM-ABLES	J. LIVESTOCK	K. DRUGS	L. MARINE ITEMS	M. CONSTRUCTION ITEMS	N. LAWN AND GARDEN	O. SPORTING GOODS	P. MISC BICYCLE
STOLEN	\$	\$	\$	\$	\$	\$	\$	\$	
RECOVERED	\$	\$	\$	\$	\$	\$	\$	\$	

27. PROPERTY RECOVERED: LOCALLY _____ OTHER JURISDICTION _____ (INSERT O OR L)

PROPERTY ITEMIZATION	PROPERTY STOLEN/RECOVERED ITEMIZATION, USE THE FOLLOWING FORMAT				
	28. QUANTITY	29. ARTICLE NAME	30. BRAND NAME	31. SERIAL NUMBER	
					S <input type="checkbox"/> R <input type="checkbox"/>
					S <input type="checkbox"/> R <input type="checkbox"/>
					S <input type="checkbox"/> R <input type="checkbox"/>
					S <input type="checkbox"/> R <input type="checkbox"/>

33. PROPERTY DAMAGE AMOUNT \$ _____

34. INSURANCE COMPANY _____

35. OFFICER ASSAULTED Y N

36. ARSON Y N

37. STRUCTURE CODE _____

38. DAMAGE \$ _____

47. CIB ENTERED CANCELLED

NCIC

OTHER BROADCAST

48. TOTAL AMOUNT PROPERTY STOLEN \$ _____

49. TOTAL AMOUNT PROPERTY RECOVERED \$ _____

50. IS REPORT CONTINUED? YES NO

51. CAUTION INDICATORS, ATLS ETC.

52. DATA PROCESS INFORMATION:

COMPUTER ENTERED DATE

MICROFILM INDEXED INITIAL _____

53. FILE APPROVAL

IS CASE CLASSIFICATION CORRECT? Y N

IF N HAS CORRECTION BEEN MADE? Y N

BY  DATE 11/10/99

000 IV 00900 1000 1000

4. INCIDENT *Crime Stopper S99-00242*

5. INCIDENT LOCATION

6. NAME - LAST - FIRST - MI *Anonymous* 7. D.O.B.

8. ADDRESS 9. TX-HOME

11. CITY STATE ZIP 10. TX-BUSINESS

12. DETAILS
*Rec'd info, re: suspect
Veh in N&R on CR*

INCIDENT CARD

18. ASSIGNED *Bushman 4/4/11
MTSO 9/2/99*

19. REC. BY *921* 20. DIS. BY

21. HOW REC'D.
1. 911
2. POLICE RADIO
3. PHONE
4. TTY
5. IN PERSON
6. ON VIEW
7. OFF. OFF DUTY
8. C.B. RADIO
9. OTHER

22. TYPE OF REPORT
1. INCIDENT
2. ACCIDENT
3. CITATION
4. NONE

23. STATUS
1. UNFOUNDED
2. PNL
3. OTHER
4. CLEARED
5. EXCEPT CLEARED

24. DATE CLEARED *11/10/99*

25. OFFENSE TYPE
1. ADULT NA
2. JUVENILE
3. UNKNOWN

14. REC'D 15. DISP 16. 10-23 17. 10-24
13. DAY
SUN 1 THU 5
MON 2 FRI 6
TUE 3 SAT 7
WED 4

39. (CODE S-SUSPECT W-WITNESS V-VICTIM O-OTHER)				41. D.O.B.		42. ADDRESS		43. TELEPHONE	
CODE	40. NAME-LAST	FIRST	MI						
0	VIGNALI	<i>189019</i>	LAWRENCE	W			Dunning St, Menasha	54952	

11/04/99 2322hrs. Call placed to Town of Menasha Police and I got Winebago County. They took information and passed on to have the vehicle checked sometime during the evening. MJB

11/04/99 @ 2340 Hrs.: I, Lt. M. Bushman, made contact with Menasha PD Officer Lingnoski who phoned MTSO. He stated he located a red GMC pickup truck with right front fender damage with the bumper, grill, and head lamps missing. The grill appears to have rounded corners with most of the bottom portion, silver grill, missing. The hood appeared to be in good shape. It also appeared as though the radiator had been replaced. Officer Lingnoski stated the damage did not appear to be very old. The vehicle had Sesquicentennial RP 28857T which lists to LAWRENCE VIGNALI on a 1982 GMC truck (the 10-28 is attached). Officer Lingnoski agreed to make contact at the residence and inquire as to when and where the damage occurred. He stated he will forward a report to MTSO.

The vehicle is a GMC. The way the grill description sounded, this is not a match. It is a 4-headlight assembly opposed to a single lamp on each side that we are looking for; however, the bottom lamps have been destroyed. The rounded corners on the grill are also inconsistent with the pieces we have. MJBushman
/bjc

11/10/99 Report received in my file upon returning to work from days off. Off. Lingnoski's report is complete with contact made with owner of the vehicle, Lawrence W. Vignali. It does not appear to be the vehicle we are looking for, close out. M.J. Bushman

CASE # S99-00242 No. 08953

45. IF COMPLAINANT DIFFERENT THEN CALLER, ENTER NAME, ADDRESS, D.O.B., TELEPHONE.

46. IF CODE O (OTHER) IS USED IN FIELD #39, EXPLAIN.

INCIDENT REPORT: NOTE: IF SECTION 22 ABOVE HAS NUMBER 4 CHECKED, DO NOT GO BEYOND THIS LINE WITHOUT RECORDS SECTION BEING ADVISED, OR NO RECORD ENTRIES WILL BE MADE BELOW THIS LINE.

PROPERTY VALUE	26. PROPERTY	A. CURRENCY	B. JEWELRY	C. FURS CLOTHING	D. VEHICLE (LOCAL)	E. OFFICE EQUIPMENT	F. RADIO, TV CAMERAS	G. FIREARMS	H. HOUSE-HOLD GOODS
	STOLEN	\$	\$	\$	\$	\$	\$	\$	\$
	RECOVERED	\$	\$	\$	\$	\$	\$	\$	\$
	26. PROPERTY	I. CONSUMABLES	J. LIVESTOCK	K. DRUGS	L. MARINE ITEMS	M. CONSTRUCTION ITEMS	N. LAWN AND GARDEN	O. SPORTING GOODS	P. MISC BICYCLE
STOLEN	\$	\$	\$	\$	\$	\$	\$	\$	
RECOVERED	\$	\$	\$	\$	\$	\$	\$	\$	

27. PROPERTY RECOVERED: LOCALLY _____ OTHER JURISDICTION _____ (INSERT O OR L)

PROPERTY ITEMIZATION	PROPERTY STOLEN/RECOVERED ITEMIZATION, USE THE FOLLOWING FORMAT				32. CODE
	28. QUANTITY	29. ARTICLE NAME	30. BRAND NAME	31. SERIAL NUMBER	
					S <input type="checkbox"/> R <input type="checkbox"/>
					S <input type="checkbox"/> R <input type="checkbox"/>
					S <input type="checkbox"/> R <input type="checkbox"/>
					S <input type="checkbox"/> R <input type="checkbox"/>
					S <input type="checkbox"/> R <input type="checkbox"/>
					S <input type="checkbox"/> R <input type="checkbox"/>

33. PROPERTY DAMAGE AMOUNT \$ _____

34. INSURANCE COMPANY _____

35. OFFICER ASSAULTED: Y N

36. ARSON: Y N

37. STRUCTURE CODE _____

38. DAMAGE \$ _____

47. CIB

NCIC

OTHER BROADCAST

ENTERED

CANCELLED

48. TOTAL AMOUNT PROPERTY STOLEN \$ _____

49. TOTAL AMOUNT PROPERTY RECOVERED \$ _____

50. IS REPORT CONTINUED? YES NO

51. CAUTION INDICATORS, ATLS ETC.

52. DATA PROCESS INFORMATION:

COMPUTER ENTERED

DATE

11/10/99

MICROFILM INDEXED

INITIAL

AS

53. FILE APPROVAL

IS CASE CLASSIFICATION CORRECT?
IF N HAS CORRECTION BEEN MADE?

Y N

BY

[Signature]

DATE

11/08/99

Town of Menasha Police Department

2000 Municipal Drive, Neenah, WI 54956

Telephone: [REDACTED] Fax: [REDACTED]

email - [REDACTED]

FAX TRANSMISSION COVER SHEET

Date: 11-5-99 Time: _____
To: G. Bushman - Manitowoc Sheriff's Dept.
Fax: _____
Subject: [REDACTED]
Sender: Linda

YOU SHOULD RECEIVE (4) PAGE(S), INCLUDING THIS COVER SHEET. IF YOU DO NOT RECEIVE ALL THE PAGES, PLEASE CALL [REDACTED]

The documents accompanying this telecopy transmission contain information from the Town of Menasha Police Department, which is confidential and/or privileged. This information is intended to be for the use of the individual or entity named on this transmission sheet. If you are not the intended recipient, be aware that any disclosure, copying, distribution or use of the contents of this information is prohibited, and may constitute an invasion of the privacy of the intended recipient. If you have received this telecopy in error, please notify us by telephone immediately so that we can arrange for the retrieval of the transmitted document at no cost to you.

COMMENTS:

PIRDETL

Winnebago County LIVE RMS
Town of Menasha Police Department
INCIDENT DETAILS

Page: 2
11/05/1999

***** INCIDENT DATA *****

Rpt #: 99-6015 Reported Date: 11/04/1999 Time: 23:22 Type: Assist Department

***** NARRATIVE INDEX *****

---ID---	-----Content-Description-----
CC: LT. BUSHMAN/MANITOWOC COUNTY SHERIFF'S DEPARTMENT	

██████ - ██████ - ██████

X ██████
11-5-99

1. CASE # S99 No 08967 2. CLASSIFICATION 63111 3. CENSUS 610000

4. INCIDENT CS 599-00242

5. INCIDENT LOCATION CTH CR

6. NAME - LAST - FIRST - MI ANONYMOUS 7. D.O.B.

8. ADDRESS E. TX-HOME

11. CITY STATE ZIP 10. TX-BUSINESS

12. DETAILS
 REPORTS CHEV BLAZER PARKED ALONG
 RESIDENCE IN BACK WITH ITEMS IN FRONT
 OF VEHICLE AS IF TO CAMOUFLAGE
 THE FRONT END - [REDACTED] S. 11 St, MTWC.

11-02-99 1734

14. REC'D.	15. DISP	16. 10-23	17. 10-24
13. DAY			
SUN 1		THU 5	
MON 2		FRI 6	
TUE 3		SAT 7	
WED 4			

MANITOWOC COUNTY SHERIFF INCIDENT CARD

18. ASSIGNED
 INFO 91811
 BUSHMAN 41411

19. REC. BY 939	20. DIS. BY 939	22. TYPE OF REPORT 1. INCIDENT 2. ACCIDENT 3. CITATION 4. NONE
21. HOW REC'D. 1. 911 2. POLICE RADIO 3. PHONE 4. TTY 5. IN PERSON 6. ON VIEW 7. OFF. OFF DUTY 8. C.B. RADIO 9. OTHER		23. STATUS 1. UNFOUNDED 2. PNL 3. OTHER 4. CLEARED 5. EXCEPT CLEARED
24. DATE CLEARED 1/10/99		25. OFFENSE TYPE 1. ADULT <input type="checkbox"/> NA <input type="checkbox"/> 2. JUVENILE <input type="checkbox"/> 3. UNKNOWN <input type="checkbox"/>

39. CODE	40. NAME-LAST	FIRST	MI	41. D.O.B.	42. ADDRESS	43. TELEPHONE
0	YINDRA	GARY	A	[REDACTED]	[REDACTED] S 11th St, Manitowoc	

11/02/99 @ 2210 Hrs.: I, Lt. M. Bushman, did a drive-by past the YINDRA residence at [REDACTED] S 11th St, Manitowoc. I observed the Chevrolet Blazer parked on the south side of the residence near the back of the house. It was blue and white in color and had an RP of RZK534, expiring 05/99. The RP comes back on a 1986 Chevrolet listing to GARY YINDRA. There was no light on in the residence.

The vehicle was in plain view from the street, and I did walk in the driveway and adjoining property to get a better view of the front of the vehicle. It was parked facing west, away from the street. I noted there was a snowplow attachment on the front of the rig and the grill, headlight assembly, and hood behind the plow attachment had no damage. The vehicle apparently must have broke down and was parked. It was noted by the grass growing tall above the tires and into the rims that the vehicle had been parked there for quite some time, at least the entire summer. It did not appear as though it had been used in the recent past. I also looked at the tires which were on the vehicle for an extended period of time noted by the rust on the rim nuts. It was noted the tread design was not similar to the vehicle in the HOCHSTETLER incident as these tires had aggressive thread and were extremely wide. The vehicle was parked in the back of the residence again because it had not been used for quite some time.

It was also noted there is a Chevrolet or GMC full-sized van which was parked immediately to the west of the Blazer. This is a custom design type of van, estimated to be around a 1980 model. It does have the double headlight configuration with no grill. It was also noted the radiator and engine had been removed from the van. Judging by the growth of various ground cover entangled in the frame and rims of the vehicle, this vehicle also has been parked for an extensive period of time. It is my opinion that it has been there for over a year.

I do not believe that either of these vehicles is the suspect vehicle in the HOCHSTETLER accident. This complaint can be closed. MJBushman /bjc

S99 No 08967

45. IF COMPLAINANT DIFFERENT THEN CALLER, ENTER NAME, ADDRESS. D.O.B.. TELEPHONE.

46. IF CODE O (OTHER) IS USED IN FIELD #39, EXPLAIN.

INCIDENT REPORT: NOTE: IF SECTION 22 ABOVE HAS NUMBER 4 CHECKED, DO NOT GO BEYOND THIS LINE WITHOUT RECORDS SECTION BEING ADVISED, OR NO RECORD ENTRIES WILL BE MADE BELOW THIS LINE.

PROPERTY VALUE	26. PROPERTY	A. CURRENCY	B. JEWELRY	C. FURS CLOTHING	D. VEHICLE (LOCAL)	E. OFFICE EQUIPMENT	F. RADIO, TV CAMERAS	G. FIREARMS	H. HOUSE-HOLD GOODS
	STOLEN	\$	\$	\$	\$	\$	\$	\$	\$
	RECOVERED	\$	\$	\$	\$	\$	\$	\$	\$
	26. PROPERTY	I. CONSUMABLES	J. LIVESTOCK	K. DRUGS	L. MARINE ITEMS	M. CONSTRUCTION ITEMS	N. LAWN AND GARDEN	O. SPORTING GOODS	P. MISC BICYCLE
STOLEN	\$	\$	\$	\$	\$	\$	\$	\$	
RECOVERED	\$	\$	\$	\$	\$	\$	\$	\$	

27. PROPERTY RECOVERED: LOCALLY _____ OTHER JURISDICTION _____ (INSERT O OR L)

PROPERTY ITEMIZATION	PROPERTY STOLEN/RECOVERED ITEMIZATION, USE THE FOLLOWING FORMAT				
	28. QUANTITY	29. ARTICLE NAME	30. BRAND NAME	31. SERIAL NUMBER	32. CODE
					S R <input type="checkbox"/> <input type="checkbox"/>
					S R <input type="checkbox"/> <input type="checkbox"/>
					S R <input type="checkbox"/> <input type="checkbox"/>
					S R <input type="checkbox"/> <input type="checkbox"/>
					S R <input type="checkbox"/> <input type="checkbox"/>
					S R <input type="checkbox"/> <input type="checkbox"/>

33. PROPERTY DAMAGE AMOUNT \$ _____ 34. INSURANCE COMPANY _____

35. OFFICER ASSAULTED Y N 36. ARSON Y N 37. STRUCTURE CODE _____ 38. DAMAGE \$ _____

47. CIB ENTERED CANCELLED
 NCIC
 OTHER BROADCAST

48. TOTAL AMOUNT PROPERTY STOLEN \$ _____

49. TOTAL AMOUNT PROPERTY RECOVERED \$ _____

50. IS REPORT CONTINUED? YES NO

51. CAUTION INDICATORS, ATLS ETC.

52. DATA PROCESS INFORMATION:

COMPUTER ENTERED DATE 11/14/99
 MICROFILM INDEXED INITIAL *AS*

IS CASE CLASSIFICATION CORRECT? N
 IF N HAS CORRECTION BEEN MADE? Y

53. FILE APPROVAL

BY *[Signature]* DATE 11/10/99

1. CASE # S99 No 09280 | 2. CLASSIFICATION 6310.11 | 3. CENSUS 5210.00

4. INCIDENT CS See S99-00242

5. INCIDENT LOCATION

6. NAME LAST FIRST MI [REDACTED] 479697 | 7. D.O.B.

8. ADDRESS [REDACTED] | 9. TX-HOME [REDACTED]

11. CITY [REDACTED] STATE [REDACTED] ZIP [REDACTED] | 10. TX-BUSINESS [REDACTED]

12. DETAILS
 COMPL. PURCHASED CHEV. FULL SZ

P-U TRUCK JAN 30 '99 w/ GRILL

DAM. / IS WILLING TO HAVE OFFER

CK. VEH. PARKED @ ABOVE LOC.

11-11-99 1132
 11-11-99 11
 14. REC'D 15. DISP 16. 10-23 17. 10-24
 13. DAY
 SUN 1 THU 5
 MON 2 FRI 6
 TUE 3 SAT 7
 WED 4

MANITOWOC COUNTY SHERIFF
 INCIDENT CARD

18. ASSIGNED
 MTSO 9:29

19. REC. BY 930 | 20. DIS. BY 930

21. HOW REC'D.
 1. 911
 2. POLICE RADIO
 3. PHONE
 4. TTY
 5. IN PERSON
 6. ON VIEW
 7. OFF. OFF DUTY
 8. C.B. RADIO
 9. OTHER
 21A. M.O.

22. TYPE OF REPORT
 1. INCIDENT
 2. ACCIDENT
 3. CITATION
 4. NONE
 23. STATUS
 1. UNFOUNDED
 2. PNL
 3. OTHER
 4. CLEARED
 5. EXCEPT CLEARED

24. DATE CLEARED 11/15/99
 25. OFFENSE TYPE
 1. ADULT NA
 2. JUVENILE
 3. UNKNOWN

39. (CODE S-SUSPECT W-WITNESS V-VICTIM O-OTHER)

CODE	40. NAME-LAST	FIRST	MI	41. D.O.B.	42. ADDRESS	43. TELEPHONE
0	[REDACTED]			[REDACTED]	[REDACTED]	[REDACTED]

11/14/99 Vehicle in question was parked in the yard near the barn. Off. called prior to going to the residence. Owner was going to bed but told Officer to feel free to stop and check the truck. There was grille damage on the right or passenger side of the front end with a 10x12 inch pc. missing. Duct tape was secured in its place cut to conform with the rest of the grille. No other damage noted to radiator, hood, or bumper and all parts appeared to be original as their wear was consistent with the rest of the vehicle. Key grille pcs found at accident scene were not missing from this truck. Tires were also oversized and rusted tight. I did not suspect this to be the suspect vehicle.

Registration AM30671. M.J. Bushman

45. IF COMPLAINANT DIFFERENT THEN CALLER, ENTER NAME, ADDRESS, D.O.B., TELEPHONE.

46. IF CODE O (OTHER) IS USED IN FIELD #39, EXPLAIN.

INCIDENT REPORT: NOTE: IF SECTION 22 ABOVE HAS NUMBER 4 CHECKED, DO NOT GO BEYOND THIS LINE WITHOUT RECORDS SECTION BEING ADVISED, OR NO RECORD ENTRIES WILL BE MADE BELOW THIS LINE.

PROPERTY VALUE	26. PROPERTY	A. CURRENCY	B. JEWELRY	C. FURS CLOTHING	D. VEHICLE (LOCAL)	E. OFFICE EQUIPMENT	F. RADIO, TV CAMERAS	G. FIREARMS	H. HOUSE-HOLD GOODS
	STOLEN	\$	\$	\$	\$	\$	\$	\$	\$
	RECOVERED	\$	\$	\$	\$	\$	\$	\$	\$
	26. PROPERTY	I. CONSUMABLES	J. LIVESTOCK	K. DRUGS	L. MARINE ITEMS	M. CONSTRUCTION ITEMS	N. LAWN AND GARDEN	O. SPORTING GOODS	P. MISC BICYCLE
	STOLEN	\$	\$	\$	\$	\$	\$	\$	\$
	RECOVERED	\$	\$	\$	\$	\$	\$	\$	\$

27. PROPERTY RECOVERED: LOCALLY _____ OTHER JURISDICTION _____ (INSERT O OR L)

PROPERTY ITEMIZATION	PROPERTY STOLEN/RECOVERED ITEMIZATION, USE THE FOLLOWING FORMAT				32. CODE S R <input type="checkbox"/> <input type="checkbox"/>	
	28. QUANTITY	29. ARTICLE NAME	30. BRAND NAME	31. SERIAL NUMBER		

33. PROPERTY DAMAGE AMOUNT \$ _____

34. INSURANCE COMPANY _____

35. OFFICER ASSAULTED Y N

36. ARSON Y N

37. STRUCTURE CODE _____

38. DAMAGE \$ _____

47. CIB ENTERED CANCELLED
 NCIC
 OTHER BROADCAST

48. TOTAL AMOUNT PROPERTY STOLEN \$ _____

49. TOTAL AMOUNT PROPERTY RECOVERED \$ _____

50. IS REPORT CONTINUED? YES NO

51. CAUTION INDICATORS, ATLS ETC.

52. DATA PROCESS INFORMATION:

COMPUTER ENTERED DATE 11/15/99

MICROFILM INDEXED INITIAL KS

IS CASE CLASSIFICATION CORRECT? Y N
 IF N HAS CORRECTION BEEN MADE? Y N

53. FILE APPROVAL

BY 

DATE 11/15/99

1. CASE # S99 No 09825 2. CLASSIFICATION 6301 3. CENSUS 14002

4. INCIDENT CS/ 599-00242

5. INCIDENT LOCATION Hwy CR + Silver Ck RD.

6. NAME - LAST, FIRST - MI Anonymous 7. D.O.B

8. ADDRESS 9. TX-HOME

11. CITY STATE ZIP 10. TX-BUSINESS

12. DETAILS GMC van observed

on Hwy 23 in

Marengo, IL with

missing grill. (See attached)
(Veh. is for sale.)

11/29/99 1900
1926
REC'D 14. 15. 16. 17.
DISP 10-23 10-24
SUN 1 THU 5
MON 2 FRI 6
TUE 3 SAT 7
WED 4

MANITOWOC COUNTY SHERIFF
INCIDENT CARD

18. ASSIGNED Lt. Bushman 4411
MISO 9219

19. REC. BY 925 20. DIS. BY
22. TYPE OF REPORT
1. INCIDENT
2. ACCIDENT
3. CITATION
4. NONE

21. HOW REC'D.
1. 911
2. POLICE RADIO
3. PHONE
4. TTY
5. IN PERSON
6. ON VIEW
7. OFF. OFF DUTY
8. C.B. RADIO
9. OTHER
23. STATUS
1. UNFOUNDED
2. PNL
3. OTHER
4. CLEARED
5. EXCEPT CLEARED

24. DATE CLEARED 10/27/00
25. OFFENSE TYPE
1. ADULT NA
2. JUVENILE
3. UNKNOWN

21A. M.O.

39. (CODE S-SUSPECT W-WITNESS V-VICTIM O-OTHER)				42. ADDRESS		43. TELEPHONE
CODE	40. NAME-LAST	FIRST	MI	41. D.O.B.		

11/29/99 2055hrs Teletype with inquire as to whether there is a Marengo, Ill PD. Information about the incident and specifically the Crimes Stopper just recieved was sent via Fax, waiting for response.M.J.Bushman

45. IF COMPLAINANT DIFFERENT THEN CALLER, ENTER NAME, ADDRESS, D.O.B., TELEPHONE.

46. IF CODE O (OTHER) IS USED IN FIELD #39, EXPLAIN.

INCIDENT REPORT: NOTE: IF SECTION 22 ABOVE HAS NUMBER 4 CHECKED, DO NOT GO BEYOND THIS LINE WITHOUT RECORDS SECTION BEING ADVISED, OR NO RECORD ENTRIES WILL BE MADE BELOW THIS LINE.

PROPERTY VALUE	26. PROPERTY	A. CURRENCY	B. JEWELRY	C. FURS CLOTHING	D. VEHICLE (LOCAL)	E. OFFICE EQUIPMENT	F. RADIO, TV CAMERAS	G. FIREARMS	H. HOUSE-HOLD GOODS
	STOLEN	\$	\$	\$	\$	\$	\$	\$	\$
	RECOVERED	\$	\$	\$	\$	\$	\$	\$	\$
	26. PROPERTY	I. CONSUMABLES	J. LIVESTOCK	K. DRUGS	L. MARINE ITEMS	M. CONSTRUCTION ITEMS	N. LAWN AND GARDEN	O. SPORTING GOODS	P. MISC BICYCLE
	STOLEN	\$	\$	\$	\$	\$	\$	\$	\$
	RECOVERED	\$	\$	\$	\$	\$	\$	\$	\$

27. PROPERTY RECOVERED: LOCALLY _____ OTHER JURISDICTION _____ (INSERT O OR L)

PROPERTY ITEMIZATION	PROPERTY STOLEN/RECOVERED ITEMIZATION, USE THE FOLLOWING FORMAT				
	28. QUANTITY	29. ARTICLE NAME	30. BRAND NAME	31. SERIAL NUMBER	32. CODE
					S R <input type="checkbox"/> <input type="checkbox"/>
					S R <input type="checkbox"/> <input type="checkbox"/>
					S R <input type="checkbox"/> <input type="checkbox"/>
					S R <input type="checkbox"/> <input type="checkbox"/>
					S R <input type="checkbox"/> <input type="checkbox"/>

33. PROPERTY DAMAGE AMOUNT \$ _____ 34. INSURANCE COMPANY _____

35. OFFICER ASSAULTED Y N 36. ARSON Y N 37. STRUCTURE CODE _____ 38. DAMAGE \$ _____

47. CIB	ENTERED <input type="checkbox"/>	CANCELLED <input type="checkbox"/>	48. TOTAL AMOUNT PROPERTY STOLEN \$ _____
NCIC	<input type="checkbox"/>	<input type="checkbox"/>	
OTHER BROADCAST	<input type="checkbox"/>	<input type="checkbox"/>	
			49. TOTAL AMOUNT PROPERTY RECOVERED \$ _____

50. IS REPORT CONTINUED? YES NO 51. CAUTION INDICATORS, ATLS ETC.

52. DATA PROCESS INFORMATION:

COMPUTER ENTERED DATE 5/17/00

MICROFILM INDEXED INITIAL KS

IS CASE CLASSIFICATION CORRECT? N
IF N HAS CORRECTION BEEN MADE? Y N

53. FILE APPROVAL
BY KS DATE 05/16/00

1. CASE # S99 No 09827	2. CLASSIFICATION 6.310.11	3. CENSUS 3.1 10.00
4. INCIDENT CS /S99-00242		
5. INCIDENT LOCATION CLEVELAND		
6. NAME - LAST - FIRST - MI ANONY.	7. D.O.B. (2)	
8. ADDRESS		9. TX-HOME
11. CITY	STATE	ZIP
10. TX-BUSINESS		
12. DETAILS See Attached Worksheet.		

2108
11-29-99

14. RECD	15. DISP	16. 10-23	17. 10-24
13. DAY			
SUN 1	THU 5		
MON 2	FRI 6		
TUE 3	SAT 7		
WED 4			

MANITOWOC COUNTY SHERIFF INCIDENT CARD		
18. ASSIGNED Lt. BUSHMAN		41411
19. REC. BY 938	20. DIS. BY	22. TYPE OF REPORT 1. INCIDENT
21. HOW REC'D. 3. PHONE		23. STATUS 3. OTHER
24. DATE CLEARED 11/21/99		25. OFFENSE TYPE 1. ADULT

39. (CODE S-SUSPECT W-WITNESS V-VICTIM O-OTHER)	40. NAME - LAST	FIRST	MI	41. D.O.B.	42. ADDRESS	43. TELEPHONE
0	BYRUM	100316	RICHARD	E	██████████ Marshall Ave, Cleveland	██████████

11/29/99 @ 2150 Hrs.: I, Lt. M. Bushman, upon returning to work, received a Crime Stopper report from an anonymous source who stated RICHARD BYRUM owns a Chevrolet van that matches the van shown on Channel 11 News. The caller stated he has never seen any damage on the van; however, BYRUM owns a body shop in Cleveland and is known to drive CTH CR from Manitowoc to Cleveland. The caller stated BYRUM was not seen for a while after the accident happened.

Contact was made by phone with BYRUM, and arrangements were made for me to meet with him at his residence within the hour.

BYRUM suspected I was coming to talk to him about his van as he had been stopped once before and questioned in the summer months when he drove his van into the City of Manitowoc. They questioned not any damage on the nose of the vehicle but the broken windshield. BYRUM stated he does not own nor does a close friend/relative own a body shop. He does, however, restore classic sports cars. He does not do any of the body work himself because he stated he was "lousy at it." The van in question is a 1985 Chevrolet with RP AK69257. He had one other van which was a 1980 GMC; however, that was sold over a year ago. That van was gray in color, and he only owned it a short time. BYRUM stated he had a lot of trouble with it, and he never drove it.

I viewed the blue van parked in the yard and noted the windshield was broken; however, BYRUM explained, a long, 14' board was obtained from Menard's and the yard attendant put the board into his van, running it ahead too far cracking the windshield.

BYRUM stated, during the time of the accident, he had been working at a project in January through August in the City of Sheboygan Falls. BYRUM also does restoration on old homes. The job site was a Sheboygan Falls residence that he was working on at that time of the year. BYRUM occasionally gets up to Manitowoc; however, he would be more likely to go to Sheboygan.

CASE # S99 No 098

45. IF COMPLAINANT DIFFERENT THEN CALLER, ENTER NAME, ADDRESS, D.O.B., TELEPHONE.

46. IF CODE O (OTHER) IS USED IN FIELD #39, EXPLAIN.

INCIDENT REPORT: NOTE: IF SECTION 22 ABOVE HAS NUMBER 4 CHECKED, DO NOT GO BEYOND THIS LINE WITHOUT RECORDS SECTION BEING ADVISED, OR NO RECORD ENTRIES WILL BE MADE BELOW THIS LINE.

PROPERTY VALUE	26. PROPERTY	A. CURRENCY	B. JEWELRY	C. FURS CLOTHING	D. VEHICLE (LOCAL)	E. OFFICE EQUIPMENT	F. RADIO, TV CAMERAS	G. FIREARMS	H. HOUSE-HOLD GOODS
	STOLEN	\$	\$	\$	\$	\$	\$	\$	\$
	RECOVERED	\$	\$	\$	\$	\$	\$	\$	\$
	26. PROPERTY	I. CONSUM-ABLES	J. LIVESTOCK	K. DRUGS	L. MARINE ITEMS	M. CONSTRUCTION ITEMS	N. LAWN AND GARDEN	O. SPORTING GOODS	P. MISC BICYCLE
	STOLEN	\$	\$	\$	\$	\$	\$	\$	\$
	RECOVERED	\$	\$	\$	\$	\$	\$	\$	\$

27. PROPERTY RECOVERED: LOCALLY _____ OTHER JURISDICTION _____ (INSERT O OR L)

PROPERTY ITEMIZATION	PROPERTY STOLEN/RECOVERED ITEMIZATION, USE THE FOLLOWING FORMAT					
	28. QUANTITY	29. ARTICLE NAME	30. BRAND NAME	31. SERIAL NUMBER	32. CODE	
					S <input type="checkbox"/>	R <input type="checkbox"/>
					S <input type="checkbox"/>	R <input type="checkbox"/>
					S <input type="checkbox"/>	R <input type="checkbox"/>
					S <input type="checkbox"/>	R <input type="checkbox"/>
					S <input type="checkbox"/>	R <input type="checkbox"/>

33. PROPERTY DAMAGE AMOUNT \$ _____

34. INSURANCE COMPANY _____

35. OFFICER ASSAULTED Y N

36. ARSON Y N

37. STRUCTURE CODE _____

38. DAMAGE \$ _____

47. CIB ENTERED CANCELLED
 NCIC
 OTHER BROADCAST

48. TOTAL AMOUNT PROPERTY STOLEN \$ _____

49. TOTAL AMOUNT PROPERTY RECOVERED \$ _____

50. IS REPORT CONTINUED? YES NO

51. CAUTION INDICATORS, ATLS ETC.

52. DATA PROCESS INFORMATION:

COMPUTER ENTERED DATE 12/3/99

MICROFILM INDEXED INITIAL KS

IS CASE CLASSIFICATION CORRECT? Y N
 IF N HAS CORRECTION BEEN MADE? N

53. FILE APPROVAL

BY PK

DATE 12/02/99

MANITOWOC COUNTY SHERIFF'S DEPARTMENT
FOLLOW-UP REPORT

Page: 2

CASE NUMBER: 599-09827 CLASSIFICATION: _____

INCIDENT: _____

DATE AND TIME: _____

REPORT CONTINUED:

way through to look at it.

It should be noted the type of van which BYRUM has in his yard is not the type of vehicle we are looking for. It is Chevrolet van; however, the grill work is different from the one we are looking for, and it has double headlights on each side, not the single with running lights under them. I viewed the grill, hood, bumper, and inside shroud on the van quite extensively. There was no damage that would be consistent to that of the hit and run vehicle. None of the parts under the hood or bottom looking up appeared to be out of place. All seemed to have weathered the age of the vehicle together.

This would not be the suspect vehicle we are looking for. MJBushman *[Signature]* /bjc

1. CASE # S99 No 09861	2. CLASSIFICATION 6310.11	3. CENSUS 701900
4. INCIDENT CS / S99-00242		
5. INCIDENT LOCATION		
6. NAME - LAST - FIRST - MI ANONYMOUS	7. D.O.B.	
8. ADDRESS	9. TX-HOME	
11. CITY STATE ZIP	10. TX-BUS NESS	
12. DETAILS INFO OF SUSP. NAME GIVEN FOR H-R FATALITY.		

1145
120199

14. REC'D	15. DISP	16. 10-23	17. 10-24
13. DAY			
SUN 1	THU 5		
MON 2	FRI 6		
TUE 3	SAT 7		
(WED 4)			

MANITOWOC COUNTY SHERIFF INCIDENT CARD		
18. ASSIGNED Crime Stopper 9129		
19. REC. BY 923	20. DIS. BY	22. TYPE OF REPORT <input checked="" type="radio"/> INCIDENT <input type="radio"/> ACCIDENT <input type="radio"/> CITATION <input type="radio"/> NONE
21. HOW REC'D <input checked="" type="radio"/> 911 <input type="radio"/> POLICE RADIO <input type="radio"/> PHONE <input type="radio"/> TTY <input type="radio"/> IN PERSON <input type="radio"/> ON VIEW <input type="radio"/> OFF. OFF DUTY <input type="radio"/> C.B. RADIO <input type="radio"/> OTHER		23. STATUS <input type="radio"/> UNFOUNDED <input type="radio"/> PNL <input checked="" type="radio"/> OTHER <input type="radio"/> CLEARED <input type="radio"/> EXCEPT CLEARED
21A. M.O.		24. DATE CLEARED 12/09/99
		25. OFFENSE TYPE <input type="checkbox"/> ADULT <input type="checkbox"/> NA <input type="checkbox"/> <input type="checkbox"/> JUVENILE <input type="checkbox"/> <input type="checkbox"/> UNKNOWN <input type="checkbox"/>

39. (CODE S-SUSPECT W-WITNESS V-VICTIM O-OTHER)	40. NAME-LAST	FIRST	MI	41. D.O.B.	42. ADDRESS	43. TELEPHONE
W	DEKKER	ALLAN	J		N 27th St. Sheboygan 53081	
O	DEKKER	ALAN	E		6th St. Kiel	

12/02/99 @ 2100 Hrs.: Contact was attempted with the anonymous provider of this information; however, there was no answer on 2 separate attempts.

I, Lt. M. Bushman, attempted to look for ALLAN DEKKER in our in-house but met with little luck.

Contact was made with SBPD. They had 3 ALLAN DEKKER'S in their in-house. One party, ALLAN J. DEKKER, is 44 years old and has a Sheboygan listed. The second is ALAN E. DEKKER from Kiel who is 38 years old and closely resembles the description given by the anonymous caller.

One further attempt was made to contact the anonymous provider of information; however, there was no answer.

More follow-up required. MJBushman /bjc

12/06/99 @ 2230 Hrs.: I, Lt. M. Bushman, attempted contact with ALAN E. DEKKER at [redacted] 6th St. Kiel. There were no lights on and no sign of the 1987 Chevrolet which is registered to him.

12/07/99 @ 2140 Hrs.: I did a drive-by of [redacted] 6th St. Kiel, and noted a white Suburban parked in the yard which would fit the description of the vehicle in this Crime Stopper complaint. I noted there was light in the upstairs apartment which is [redacted] 6th St.

Contact was made with Sgt. Gaedtke of Kiel PD to advise him that I would be in his City on some follow-up. He accompanied me to [redacted] 6th St.

Contact was made with ALAN E. DEKKER. ALAN was informed of the nature of this complaint, being a Crime Stopper, and that he allegedly had a vehicle matching this description. ALAN stated, at the time of the incident, he was still living in the City of Sheboygan at [redacted] N 6th St. He stated the only vehicle that fit the description that officers were looking for

S99 No 09861

45. IF COMPLAINANT DIFFERENT THEN CALLER, ENTER NAME, ADDRESS, D.O.B., TELEPHONE.

46. IF CODE O (OTHER) IS USED IN FIELD #39, EXPLAIN.

INCIDENT REPORT: NOTE: IF SECTION 22 ABOVE HAS NUMBER 4 CHECKED, DO NOT GO BEYOND THIS LINE WITHOUT RECORDS SECTION BEING ADVISED. OR NO RECORD ENTRIES WILL BE MADE BELOW THIS LINE.

PROPERTY VALUE	26. PROPERTY	A. CURRENCY	B. JEWELRY	C. FURS CLOTHING	D. VEHICLE (LOCAL)	E. OFFICE EQUIPMENT	F. RADIO, TV CAMERAS	G. FIREARMS	H. HOUSE-HOLD GOODS
	STOLEN	\$	\$	\$	\$	\$	\$	\$	\$
	RECOVERED	\$	\$	\$	\$	\$	\$	\$	\$
	26. PROPERTY	I. CONSUMABLES	J. LIVESTOCK	K. DRUGS	L. MARINE ITEMS	M. CONSTRUCTION ITEMS	N. LAWN AND GARDEN	O. SPORTING GOODS	P. MISC BICYCLE
	STOLEN	\$	\$	\$	\$	\$	\$	\$	\$
	RECOVERED	\$	\$	\$	\$	\$	\$	\$	\$

27. PROPERTY RECOVERED: LOCALLY _____ OTHER JURISDICTION _____ (INSERT O OR L)

PROPERTY ITEMIZATION	PROPERTY STOLEN/RECOVERED ITEMIZATION, USE THE FOLLOWING FORMAT				
	28. QUANTITY	29. ARTICLE NAME	30. BRAND NAME	31. SERIAL NUMBER	32. CODE
					S R <input type="checkbox"/> <input type="checkbox"/>
					S R <input type="checkbox"/> <input type="checkbox"/>
					S R <input type="checkbox"/> <input type="checkbox"/>
					S R <input type="checkbox"/> <input type="checkbox"/>
					S R <input type="checkbox"/> <input type="checkbox"/>

33. PROPERTY DAMAGE AMOUNT \$ _____ 34. INSURANCE COMPANY _____

35. OFFICER ASSAULTED Y N 36. ARSON Y N 37. STRUCTURE CODE _____ 38. DAMAGE \$ _____

47. CIB	ENTERED <input type="checkbox"/>	CANCELLED <input type="checkbox"/>	48. TOTAL AMOUNT PROPERTY STOLEN \$ _____
NCIC	<input type="checkbox"/>	<input type="checkbox"/>	
OTHER BROADCAST	<input type="checkbox"/>	<input type="checkbox"/>	
			49. TOTAL AMOUNT PROPERTY RECOVERED \$ _____

50. IS REPORT CONTINUED? YES NO 51. CAUTION INDICATORS, ATLS ETC.

52. DATA PROCESS INFORMATION:

COMPUTER ENTERED DATE 12/10/99

MICROFILM INDEXED INITIAL AS

IS CASE CLASSIFICATION CORRECT? Y N

IF N HAS CORRECTION BEEN MADE? Y N

53. FILE APPROVAL

BY [Signature] DATE 12/09/99

MANITOWOC COUNTY SHERIFF'S DEPARTMENT
FOLLOW-UP REPORT

Page: 2

CASE NUMBER: 599-09861 CLASSIFICATION: _____

INCIDENT: _____

DATE AND TIME: _____

REPORT CONTINUED:

damage to the vehicle other than a small dent on the right rear quarter. He stated he has owned the vehicle for approximately 10 years. The vehicle had been painted at least 3 times. The last painting was approximately 3 years ago.

There had been damage to the front end at one point in time, estimated to be approximately 8 years ago. The front core support (radiator support), right front fender, and headlight assemblies had to be replaced as his wife struck a concrete support in Sheboygan. An accident report was not made out at that time.

DEKKER stated he seldom gets to Manitowoc; however, he had been there over the Thanksgiving weekend. He has a friend living in Two Rivers who he occasionally visits. He does not recall being in Manitowoc Co. in the month of January. He stated he is a drinker; however, he seldom stays as the last individual in the bar. A request was made for me to take a closer look at the vehicle. ALAN offered to accompany me to the driveway.

The vehicle in question is a 1987 Chevrolet Suburban with personalized RP BOARDS. I matched the VIN to the 10-28 and then took several notes about the vehicle. This vehicle is white with brown trim across the bottom and is a 2-wheel drive vehicle. It does have very large truck-type tires on the front and back. These would not be a match with the HOCHSTETLER incident. I looked the front end over fairly good but did not notice any recent repair done to the vehicle. The hood did not appear to be damaged, and the paint did match the rest of the vehicle. The grill appeared to be weathered for an extensive period of time and did fit properly in the front end.

I also noted a series of rusted snaps starting on the metal trim on the top of the grill, going through the grill with snaps attached to the grill, consistent in rust and snaps to the lower end. When questioned about the snaps, ALAN stated, several years ago, he applied a leather cover over the radiator for winter months. The cover was actually taken from a van of the same make (Chevrolet) and applied to his vehicle. I questioned if he still had the cover, and he said yes and went to the back of the vehicle to retrieve it. I asked him if he would put the leather cover over the grill, and he complied. The snaps did match up with those that were on the cover. It was my impression that these snaps had been placed in the grill and trim piece several years ago when the grill that is currently in the vehicle probably was there for an extensive period of time.

ALAN was very cooperative, and I thanked him for his assistance. He stated he did not have any other vehicles, nor had he had any other vehicles matching the description I gave him in the last 20 years.

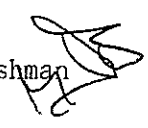
In my opinion, this is not the vehicle we are looking for. MJBushman  /bjc

1. CASE # **S99 No 09888** 2. CLASSIFICATION **63011** 3. CENSUS **141011**

4. INCIDENT **CS/S99-00242**

5. INCIDENT/LOCATION **CTH Hwy CR**

6. NAME- LAST-FIRST-MI **Anonymous** 7. D.O.B. **(2)**

8. ADDRESS _____ 9. TX-HOME _____

11. CITY _____ STATE _____ ZIP _____ 10. TX-BUSINESS _____

12. DETAILS **INFO REGARDING INCIDENT**

S99-00242

16-40
12-02-99
REC'D 14. 15. 16. 17.
DISP 10-23 10-24
13. DAY
SUN 1 THU 5
MON 2 FRI 6
TUE 3 SAT 7
WED 4

**MANITOWOC COUNTY SHERIFF
INCIDENT CARD**

18. ASSIGNED **INFO** 9/21/11
MTSO 9/29/99
M. Bushman 4/4/11

19. REC. BY **939** 20. DIS. BY **939** 22. TYPE OF REPORT
1. INCIDENT
2. ACCIDENT
3. CITATION
4. NONE

21. HOW REC'D.
1. 911
2. POLICE RADIO
3. PHONE
4. TTY
5. IN PERSON
6. ON VIEW
7. OFF. OFF DUTY
8. C.B. RADIO
9. OTHER

23. STATUS
1. UNFOUNDED
2. PNL
3. OTHER
4. CLEARED
5. EXCEPT CLEARED
24. DATE CLEARED **15/1/100**
25. OFFENSE TYPE
1. ADULT NA
2. JUVENILE
3. UNKNOWN

39. (CODE S-SUSPECT W-WITNESS V-VICTIM O-OTHER)				41. D.O.B.	42. ADDRESS	43. TELEPHONE
CODE	40. NAME- LAST	FIRST	MI			
0	ZABE	JOSHUA	T		Washington St, Manitowoc	

12/03/99 @ 0300 Hrs.: I, Lt. M. Bushman, checked the Suburban which has a repaired front end and left door that is not licensed on the NW side of a building on CTH R, one block north of Goodwin, west side. The vehicle has current RP of TWR956 which comes back on a 1984 Plymouth. This is obviously a Suburban, and the VIN was checked. The VIN was [redacted] comes back on a 1986 Chevrolet truck to JOSHUA ZABE. At first glance, I noted this was a Silverado addition Suburban in quite poor condition. I noted, however, the grill, left front fender, and driver door had been replaced. The tires are too wide on this vehicle and not consistent with the design that was found at the scene. There was a push bar in the center of the bottom, and the bumper directly under the push bar and the deflector are both bent. It appear as though the grill was replaced. I then noted the hood was ajar and lifted it. The fan shroud on the bottom edge of the van also had black pieces missing. The hood, just to the passenger side of the Chevrolet emblem above the headlights, was also dented.

Basically, there are a lot of inconsistencies with this vehicle and the suspect vehicle; however, the fan shroud makes me uneasy. This is the first vehicle I have seen with this type of damage, and this would be consistent with the HOCHSTETLER accident. Also, the fact that there is a push bar on the front may have prevented extreme damage to the radiator and radiator wall. Therefore, before I discount this vehicle completely, I would like to borrow the black fan shroud pieces from evidence and go back out to see if there is any match on the edges.

More follow-up required. MJBushman *MJB* /bjc
12/06/99 1410hrs DI Tisler and I went to evidence to collect the bag of parts so I could attempt to match. The evidence had been sent to FBI Lab for analysis and is not available at this time. M.J.Bushman *MJB*

S99 No 09888

45. IF COMPLAINANT DIFFERENT THEN CALLER, ENTER NAME, ADDRESS, D.O.B., TELEPHONE.

46. IF CODE O (OTHER) IS USED IN FIELD #39, EXPLAIN.

INCIDENT REPORT: NOTE: IF SECTION 22 ABOVE HAS NUMBER 4 CHECKED, DO NOT GO BEYOND THIS LINE WITHOUT RECORDS SECTION BEING ADVISED, OR NO RECORD ENTRIES WILL BE MADE BELOW THIS LINE.

PROPERTY VALUE	26. PROPERTY	A. CURRENCY	B. JEWELRY	C. FURS CLOTHING	D. VEHICLE (LOCAL)	E. OFFICE EQUIPMENT	F. RADIO, TV CAMERAS	G. FIREARMS	H. HOUSE-HOLD GOODS
	STOLEN	\$	\$	\$	\$	\$	\$	\$	\$
	RECOVERED	\$	\$	\$	\$	\$	\$	\$	\$
	26. PROPERTY	I. CONSUM-ABLES	J. LIVESTOCK	K. DRUGS	L. MARINE ITEMS	M. CONSTRUCTION ITEMS	N. LAWN AND GARDEN	O. SPORTING GOODS	P. MISC BICYCLE
	STOLEN	\$	\$	\$	\$	\$	\$	\$	\$
	RECOVERED	\$	\$	\$	\$	\$	\$	\$	\$

27. PROPERTY RECOVERED: LOCALLY _____ OTHER JURISDICTION _____ (INSERT O OR L)

PROPERTY ITEMIZATION	PROPERTY STOLEN/RECOVERED ITEMIZATION, USE THE FOLLOWING FORMAT				32. CODE	
	28. QUANTITY	29. ARTICLE NAME	30. BRAND NAME	31. SERIAL NUMBER		
						S R <input type="checkbox"/> <input type="checkbox"/>
						S R <input type="checkbox"/> <input type="checkbox"/>
						S R <input type="checkbox"/> <input type="checkbox"/>
						S R <input type="checkbox"/> <input type="checkbox"/>

33. PROPERTY DAMAGE AMOUNT \$ _____ 34. INSURANCE COMPANY _____

35. OFFICER ASSAULTED Y N 36. ARSON Y N 37. STRUCTURE CODE _____ 38. DAMAGE \$ _____

47. CIB	ENTERED <input type="checkbox"/>	CANCELLED <input type="checkbox"/>	48. TOTAL AMOUNT PROPERTY STOLEN \$ _____
NCIC	<input type="checkbox"/>	<input type="checkbox"/>	
OTHER BROADCAST	<input type="checkbox"/>	<input type="checkbox"/>	49. TOTAL AMOUNT PROPERTY RECOVERED \$ _____

50. IS REPORT CONTINUED? YES NO 51. CAUTION INDICATORS, ATLS ETC.

52. DATA PROCESS INFORMATION:

COMPUTER ENTERED DATE 5/17/00

MICROFILM INDEXED INITIAL KS

IS CASE CLASSIFICATION CORRECT? Y N
IF N HAS CORRECTION BEEN MADE? Y N

53. FILE APPROVAL
BY [Signature] DATE 05/16/00

1. CASE # S99 N^o 09919		2. CLASSIFICATION 571151		3. CENSUS 701000	
4. INCIDENT ADOLEA/BOSS VEH. IN HOMICIDE					
5. INCIDENT LOCATION KEWAUNEE CO					
6. NAME - LAST - FIRST - MI KEWAUNEE CO SHERIFF'S DEPT				7. D.O.B. 224	
8. ADDRESS				9. TX-HOME	
11. CITY		STATE		ZIP	
10. TX-BUSINESS				10. TX-BUSINESS	
12. DETAILS REF: POSSIBLE VEHICLE INVOLVED IN HOMICIDE. SEE ATTACHED					

12-03-99 1319
 DEC 3, 1999 1408
 DEC 3, 1999 1442
 DEC 3, 1999 1533

MANITOWOC COUNTY SHERIFF INCIDENT CARD			
18. ASSIGNED Colborn 4312		18. ASSIGNED Michael 2186	
19. REC. BY GAZ	20. DIS. BY	22. TYPE OF REPORT 1 INCIDENT	
21. HOW REC'D. 1. 911 2. POLICE RADIO 3. PHONE 4. CITY 5. IN PERSON 6. ON VIEW 7. OFF. OFF DUTY 8. C.B. RADIO 9. OTHER		23. STATUS 1. UNFOUNDED 2. PNL 3. OTHER 4. CLEARED 5. EXCEPT CLEARED	
24. DATE CLEARED 12/11/99		25. OFFENSE TYPE 1. ADULT <input type="checkbox"/> NA <input checked="" type="checkbox"/> 2. JUVENILE <input type="checkbox"/> 3. UNKNOWN <input type="checkbox"/>	

ACTUAL

39. (CODE S-SUSPECT W-WITNESS V-VICTIM O-OTHER)	40. NAME-LAST	FIRST	MI	41. D.O.B.	42. ADDRESS	43. TELEPHONE
S	MICHALETZ	RODNEY	S		Cedar Ln, Kewaunee	
W	MILLER	THOMAS	R		Cedar Ln, Kewaunee	
O	MICHALETZ	GRACE	R		Cedar Ln, Kewaunee	

12/03/99 @ 1408 Hrs.: I, Deputy A. Colborn, was notified by MTSO Dispatch that they had received a teletype from KWSO stating they had a possible suspect vehicle for incident S99-00242 in their possession. Preliminary information received from KWSO was that the owner of the vehicle is currently incarcerated in their Jail for burglaries and felon in possession of firearm. Apparently, the vehicle operated by the suspect had been impounded by KWSO.

12/03/99 @ 1442 Hrs.: I responded to KWSO where I made contact with Investigator David Cornelius and Det. Russell Rodrian (see their attached business cards). They informed me the owner of the vehicle, RODNEY MICHALETZ, was currently incarcerated in their facility for having committed numerous burglaries. Also, MICHALETZ, a convicted felon, was found to be in possession of a firearm (see attached Bench Warrant).

I observed, parked in the KWSO Garage, a blue Chevrolet pickup truck bearing WI RP AM47829. In checking this RP through WI DOT, it was found this RP is assigned to a 1979 Chevrolet pickup and belonged to GRACE R. MICHALETZ with the same address as RODNEY MICHALETZ. A check of the vehicle VIN against the RP revealed the RP was on the correct vehicle.

I observed this vehicle to appear to have had the hood replaced, the radiator replaced, the engine replaced, and both headlamp bezzles missing. I observed the grill appears to have been replaced as well as both front fenders. They either appeared to be repainted or replaced. I noted the fan shroud was missing. I noted the front bumper had been replaced with a front bumper that appeared to belong on a passenger car as opposed to a Chevrolet pickup truck. I observed the vehicle was of a custom deluxe model. I observed the front tires to be made by Duralon Corp. and to be the radial 5+ model number, size P215/70R15. These tires are sold by Fleet Farm and appear to be a close match to the tires which were on the suspect vehicle for incident S99-00242. I observed the rear tires were of different makes. The left rear tire was a General Grabber AP, size 265/75R15. The right rear tire was a Goodyear Tracker A-T, size 9-5LT.

In speaking with Investigator Cornelius and Det. Rodrian, they informed me MICHALETZ lives next door to THOMAS MILLER who has 222222 to 222222.

S99 N^o 09919

45. IF COMPLAINANT DIFFERENT THEN CALLER, ENTER NAME, ADDRESS, D.O.B., TELEPHONE.

46. IF CODE O (OTHER) IS USED IN FIELD #39, EXPLAIN.

INCIDENT REPORT: NOTE: IF SECTION 22 ABOVE HAS NUMBER 4 CHECKED, DO NOT GO BEYOND THIS LINE WITHOUT RECORDS SECTION BEING ADVISED. OR NO RECORD ENTRIES WILL BE MADE BELOW THIS LINE.

PROPERTY VALUE	26. PROPERTY	A. CURRENCY	B. JEWELRY	C. FURS CLOTHING	D. VEHICLE (LOCAL)	E. OFFICE EQUIPMENT	F. RADIO, TV CAMERAS	G. FIREARMS	H. HOUSE-HOLD GOODS
	STOLEN	\$	\$	\$	\$	\$	\$	\$	\$
	RECOVERED	\$	\$	\$	\$	\$	\$	\$	\$
	26. PROPERTY	I. CONSUMABLES	J. LIVESTOCK	K. DRUGS	L. MARINE ITEMS	M. CONSTRUCTION ITEMS	N. LAWN AND GARDEN	O. SPORTING GOODS	P. MISC BICYCLE
STOLEN	\$	\$	\$	\$	\$	\$	\$	\$	
RECOVERED	\$	\$	\$	\$	\$	\$	\$	\$	

27. PROPERTY RECOVERED: LOCALLY _____ OTHER JURISDICTION _____ (INSERT O OR L)

PROPERTY ITEMIZATION	PROPERTY STOLEN/RECOVERED ITEMIZATION, USE THE FOLLOWING FORMAT				
	28. QUANTITY	29. ARTICLE NAME	30. BRAND NAME	31. SERIAL NUMBER	32. CODE
					S R <input type="checkbox"/> <input type="checkbox"/>
					S R <input type="checkbox"/> <input type="checkbox"/>
					S R <input type="checkbox"/> <input type="checkbox"/>
					S R <input type="checkbox"/> <input type="checkbox"/>

33. PROPERTY DAMAGE AMOUNT \$ _____

34. INSURANCE COMPANY _____

35. OFFICER ASSAULTED Y N

36. ARSON Y N

37. STRUCTURE CODE _____

38. DAMAGE \$ _____

47. CIB ENTERED CANCELLED
 NCIC
 OTHER BROADCAST

48. TOTAL AMOUNT PROPERTY STOLEN \$ _____

49. TOTAL AMOUNT PROPERTY RECOVERED \$ _____

50. IS REPORT CONTINUED? YES NO

51. CAUTION INDICATORS, ATLS ETC.

52. DATA PROCESS INFORMATION:

COMPUTER ENTERED DATE 12/14/99
 MICROFILM INDEXED INITIAL KS

53. FILE APPROVAL

IS CASE CLASSIFICATION CORRECT? Y N
 IF N HAS CORRECTION BEEN MADE? Y N

BY [Signature] DATE 12/18/99

MANITOWOC COUNTY SHERIFF'S DEPARTMENT
FOLLOW-UP REPORT

Page: 2

CASE NUMBER: 599-09919 CLASSIFICATION: _____

INCIDENT: _____

DATE AND TIME: _____

REPORT CONTINUED:

MICHALETZ has been replacing the front end parts on his pickup truck and apparently made the comment to MILLER, something to the effect, "If anyone finds out about this, I'll kill you." It should further be noted the front radiator support on the Chevrolet pickup truck appeared to have been repainted or replaced as I could see that it was black on the top, but the black paint was flaking off and light blue underneath.

I, Deputy Colborn, took 3 Polaroid photos of the vehicle (see attached).

I was informed by Investigator Cornelius and Det. Rodrian that MICHALETZ stated he would be willing to speak with law enforcement reference the burglaries he committed but wished to have his attorney present. I was informed MICHALETZ'S attorney would not be available until Monday, 12/06/99.

I was also given a list of the items recovered in a Search Warrant conducted of the MICHALETZ residence. I noticed numerous construction-type tools among other items recovered. It should be noted MTSO is currently investigating S99-06940 which involved the theft of a trailer full of construction/roofing tools from a residence located at [REDACTED] CTH Q (see attached copy of S99-06940).

I observed a Polaroid photograph of MICHALETZ. Attached to S99-06940 was a forensic artist sketch of the suspect for the theft. This individual and MICHALETZ have a very close resemblance.

I then advised MTSO Dispatch to notify a Detective so I could brief him on the results of my investigation thus far. Also, Investigator Cornelius and Det. Rodrian did request that our Detective Division review recent burglaries as MICHALETZ works at WISCONSIN ALUMINUM FOUNDRY in the City of Manitowoc. Investigator Cornelius and Det. Rodrian informed me they believe MICHALETZ has committed numerous burglaries recently in the Manitowoc Co., Kewaunee Co. and Door Co. areas (see attached copy of items recovered from the Search Warrant of the MICHALETZ residence).

I returned to MTSO where I made contact with C.I. Kusche. I informed him of the results of my investigation thus far. It should be noted C.I. Kusche stated he would be speaking with Det. Michel reference this incident. I informed C.I. Kusche that MICHALETZ would be available for interview on 12/06/99.

No further action taken at this time. Upon completion of typing, a copy of this incident and all attached materials and photos should be forwarded to Det. Michel and incident commander for S99-00242, Lt. M. Bushman. ALColborn *ajc* /bjc

12/06/99: Made a copy of this report and attached paperwork for Det. Michel (put in the Detective bin in Administration) and Lt. M. Bushman (put in his drawer in Patrol) per Deputy Colborn. BJChristianson *bjc*

12/03/99: Having received information from Deputy Colborn, I (Det. Michel) immediately went to Kewaunee for follow-up on this incident.

MANITOWOC COUNTY SHERIFF'S DEPARTMENT
FOLLOW-UP REPORT

Page: 3

CASE NUMBER: 500-09919 CLASSIFICATION: _____

INCIDENT: _____

DATE AND TIME: _____

REPORT CONTINUED:

I, Det. Michel, first attempted contact at the MILLER residence which was next door to the MICHALETZ residence. THOMAS MILLER, the person I wanted to see, was not home. I left my card with the request that he contact me upon his return.

I then went to the MICHALETZ residence where I met with GRACE MICHALETZ. I informed GRACE that my contact today was only in regard to their Chevrolet truck. GRACE told me they purchased the truck in Green Bay in approximately February 1998. They needed to make a few repairs (a pressure plate and bearing) in order to use it. She said they used it some in 1998 but found the engine was bad. As far as GRACE could recall, they parked the truck in the fall of 1998. RODNEY MICHALETZ since then acquired a new engine from THOMAS MILLER as well as other parts such as a radiator and gas tank. The vehicle was running again by the summer of 1999. GRACE recalled licensing the truck for the road on 07/30/99. GRACE recalled the date as the same date she renewed her DL.

In covering some of the information with GRACE, she again stated the truck had been parked last winter and had been parked for almost a year. To her knowledge, they have never driven the vehicle during the winter or in snow. GRACE did not recall the vehicle had ever been wrecked. She stated she knew about the front bumper of the vehicle--that the bumper had been black and RODNEY wanted a chrome bumper and traded for the bumper which is now on the truck. During the conversation, she described RODNEY as not having many friends. She indicated RODNEY has quit drinking; however, she has learned via the Search Warrant that he apparently has taken up the use of THC.

I later received a page from THOMAS MILLER and was able to make contact with him. MILLER verified that he had given the motor to RODNEY to install in his Chevrolet truck and that he had done so as part of a trade for a junked car. MILLER stated the old motor was shot, the radiator leaked, and they recently fixed the starter. MILLER mentioned he was present with GRACE and RODNEY when they purchased the truck at THREE QUARTER MOTORS in Green Bay. He stated the truck had been purchased for \$350 and that RODNEY had to make payments on the vehicle. I asked MILLER if he knew how long the vehicle had been parked after it had been purchased by RODNEY. MILLER stated he knew RODNEY used the truck to move during the summer of 1998; however, the motor was bad at that time. MILLER could not be certain how long the truck had been parked; however, he stated, they did not put the new motor in the truck until this summer (summer of 1999). He stated this was when the truck first was placed back onto the roadway.

I then questioned MILLER about the replacement of the radiator in the vehicle. MILLER stated there had been 3 radiators through the vehicle already since it was purchased, adding all 3 radiators were junk. MILLER stated, eventually, RODNEY allowed him to order a new radiator rather than attempting to replace it with another junk one. This radiator now worked.

I next questioned him about damage to the vehicle. MILLER stated the body to the vehicle looks the same as when RODNEY purchased it in Green Bay. He also stated the vehicle still has the same grill as when it had been purchased. MILLER stated there was a dent in the quarter panel, one in the door, and one in the bumper--all of which were in the vehicle

MANITOWOC COUNTY SHERIFF'S DEPARTMENT
FOLLOW-UP REPORT

Page: 4

CASE NUMBER: 599-09919 CLASSIFICATION: _____

INCIDENT: _____

DATE AND TIME: _____

REPORT CONTINUED:

previous to it being purchased. When questioned directly about the grill and windshield, he stated neither of the 2 to his knowledge had ever been broke. Also, MILLER stated the hood had never been replaced on this vehicle.

It was noted the information received from MILLER did verify initial information received from GRACE. These 2 do seem to be in agreement that the truck was being repaired due to mechanical defect and during the time frame of the vehicular homicide in question that this particular vehicle was parked.

Investigation into the burglary and/or theft aspect was not conducted today as Det. Rodrian requested to first interview RODNEY and also advised that RODNEY requested representation by an attorney. JMMichel /bjc



**KEWAUNEE COUNTY
SHERIFF'S DEPARTMENT**

INVESTIGATOR DAVID CORNELIUS
Office [REDACTED]

Kewaunee County Safety Building
[REDACTED] Juneau Street
Kewaunee, Wisconsin 54216

Phone: [REDACTED]
Fax: [REDACTED]



**KEWAUNEE COUNTY
SHERIFF'S DEPARTMENT**

DETECTIVE RUSSELL RODRIAN
Office [REDACTED]

Kewaunee County Safety Building
[REDACTED] Juneau Street
Kewaunee, Wisconsin 54216

Phone: [REDACTED]
Fax: [REDACTED]

1. CASE # S99-09920	2. CLASSIFICATION 6,310,1	3. CENSUS 5,20,000
4. INCIDENT CS/S99-00242		
5. INCIDENT LOCATION		
6. NAME - LAST - FIRST - MI Anonymous	7. D.O.B.	
8. ADDRESS	9. TX-HOME	
11. CITY STATE ZIP	10. TX-BUSINESS	
12. DETAILS SEE ATTACHED.		
14. REC'D	15. DISP	17. 10-24
13. DAY SUN 1 THU 5 MON 2 FRI 6 TUE 3 SAT 7 WED 4		

1435
12/05/99

MANITOWOC COUNTY SHERIFF INCIDENT CARD		
18. ASSIGNED MTSO		9/2/9
Glaeser		4/1/7
Jost		4/1/9
19. REC. BY TAK	20. DIS. BY	22. TYPE OF REPORT 1. INCIDENT 2. ACCIDENT 3. CITATION 4. NONE
21. HOW REC'D. 1. 911 2. POLICE RADIO 3. PHONE 4. TTY 5. IN PERSON 6. ON VIEW 7. OFF. OFF DUTY 8. C.B. RADIO 9. OTHER		23. STATUS 1. UNFOUNDED 2. PNL 3. OTHER 4. CLEARED 5. EXCEPT CLEARED
21A. M.O.		24. DATE CLEARED 11/23/99
		25. OFFENSE TYPE 1. ADULT <input type="checkbox"/> NA <input type="checkbox"/> 2. JUVENILE <input type="checkbox"/> 3. UNKNOWN <input type="checkbox"/>

39. (CODE S-SUSPECT W-WITNESS V-VICTIM O-OTHER)				JUVENILE INFO REDACTED		
CODE	40. NAME-LAST	FIRST	MI	41. D.O.B.	42. ADDRESS	43. TELEPHONE
0	[REDACTED]	154907	[REDACTED]	[REDACTED]	[REDACTED]	[REDACTED]
0	KOUBA	110600	MATTHEW	M	[REDACTED] S. 20th St., Manitowoc	[REDACTED]
0	KOUBA	27860	MICHAEL	J	[REDACTED] S. 20th St., Manitowoc	[REDACTED]

Complainant contacted me at home advising that she had information that might identify the driver of the hit and run vehicle that struck and killed RICK HOCHSTETLER on 1/10/99.

Complainant states that the alleged suspect vehicle was recently sold to [REDACTED] of [REDACTED]. The vehicle in question is an older model Chevrolet Truck that has recently been repainted and possibly had front end work done on it. Reportedly there was damage to the hood and front bumper.

The person who would have owned this vehicle at the time of the hit and run would be MATTHEW M KOUBA, DOB [REDACTED]. MTSO Records indicate MATTHEW lives at [REDACTED] South 20th Street, Manitowoc and has a phone number of [REDACTED].

Another Crimestopper report shows that MATTHEW was also called in as a suspect in a bomb threat investigation at Mirro on 05/24/99. He was a suspect in that investigation because of recently having his employment with that company terminated. Information in that Crimestopper indicated he drove an older model red and cream color Chevy pickup truck.

12/05/99: I, Deputy Jost, made contact with [REDACTED] at his residence on [REDACTED] ref. to a possible suspect vehicle in the RICK HOCHSTETLER hit-and-run. Info. was given to me by Deputy Glaeser, who in turn was given the info. by Sheriff Kocourek.

Upon making contact with [REDACTED] at 1435 hrs., I observed a red and tan colored Chevy pickup truck parked in the driveway. This truck had WI RP BL37309 registering to [REDACTED]. Upon inspecting the front area of the truck, I did not observe any substantial damage to the grill/hood/fanshroud or windshield of the vehicle. [REDACTED] told me that the previous owner, MATTHEW KOUBA, apparently had the radiator changed out last year sometime. [REDACTED] told me that he has not had any work done to it since he purchased the vehicle in Aug. 1999.

There was some minor damage to the grill; however, nothing that coincided with the damage

0-110-117

45. IF COMPLAINANT DIFFERENT THEN CALLER, ENTER NAME, ADDRESS, D.O.B., TELEPHONE.

46. IF CODE 0 (OTHER) IS USED IN FIELD #39, EXPLAIN.

INCIDENT REPORT: NOTE: IF SECTION 22 ABOVE HAS NUMBER 4 CHECKED, DO NOT GO BEYOND THIS LINE WITHOUT RECORDS SECTION BEING ADVISED, OR NO RECORD ENTRIES WILL BE MADE BELOW THIS LINE.

PROPERTY VALUE	26. PROPERTY	A. CURRENCY	B. JEWELRY	C. FURS CLOTHING	D. VEHICLE (LOCAL)	E. OFFICE EQUIPMENT	F. RADIO, TV CAMERAS	G. FIREARMS	H. HOUSE-HOLD GOODS
	STOLEN	\$	\$	\$	\$	\$	\$	\$	\$
	RECOVERED	\$	\$	\$	\$	\$	\$	\$	\$
	26. PROPERTY	I. CONSUM- ABLES	J. LIVESTOCK	K. DRUGS	L. MARINE ITEMS	M. CONSTRU- TION ITEMS	N. LAWN AND GARDEN	O. SPORTING GOODS	P. MISC BICYCLE
STOLEN	\$	\$	\$	\$	\$	\$	\$	\$	
RECOVERED	\$	\$	\$	\$	\$	\$	\$	\$	

27. PROPERTY RECOVERED: LOCALLY _____ OTHER JURISDICTION _____ (INSERT O OR L)

PROPERTY ITEMIZATION	PROPERTY STOLEN/RECOVERED ITEMIZATION, USE THE FOLLOWING FORMAT				31. SERIAL NUMBER	32. CODE
	28. QUANTITY	29. ARTICLE NAME	30. BRAND NAME			
						S <input type="checkbox"/> R <input type="checkbox"/>
						S <input type="checkbox"/> R <input type="checkbox"/>
						S <input type="checkbox"/> R <input type="checkbox"/>
						S <input type="checkbox"/> R <input type="checkbox"/>
						S <input type="checkbox"/> R <input type="checkbox"/>
						S <input type="checkbox"/> R <input type="checkbox"/>

33. PROPERTY DAMAGE AMOUNT \$ _____ 34. INSURANCE COMPANY _____

35. OFFICER ASSAULTED Y N 36. ARSON Y N 37. STRUCTURE CODE _____ 38. DAMAGE \$ _____

47. CIB	ENTERED <input type="checkbox"/>	CANCELLED <input type="checkbox"/>	48. TOTAL AMOUNT PROPERTY STOLEN \$ _____
NCIC	<input type="checkbox"/>	<input type="checkbox"/>	
OTHER BROADCAST	<input type="checkbox"/>	<input type="checkbox"/>	
			49. TOTAL AMOUNT PROPERTY RECOVERED \$ _____

50. IS REPORT CONTINUED? YES NO 51. CAUTION INDICATORS, ATLS ETC.

52. DATA PROCESS INFORMATION:

COMPUTER ENTERED DATE 12/23/99

MICROFILM INDEXED INITIAL KS

IS CASE CLASSIFICATION CORRECT? Y N
IF N HAS CORRECTION BEEN MADE? Y N

53. FILE APPROVAL
BY [Signature] DATE 12/23/99

MANITOWOC COUNTY SHERIFF'S DEPARTMENT
FOLLOW-UP REPORT

Page: _____

CASE NUMBER: _____ CLASSIFICATION: _____

INCIDENT: _____

DATE AND TIME: _____

REPORT CONTINUED:

we are expecting on our suspect vehicle.

The grill and other parts of the front of the vehicle appear to be the original parts.

12/10/99 @ 1255 hrs.: I made phone contact with MICHAEL J. KOUBA, this being MATTHEW's father. I informed MICHAEL why I was calling, and MICHAEL told me that MATTHEW had a lot of problems with the vehicle after he purchased it. MICHAEL told me that he had been stopped numerous times in early 1999 by officers for different equipment violations and other incidents.

In speaking with MICHAEL, he advised that MATTHEW did not do any substantial work to the vehicle other than having the radiator and some other electronic parts replaced early in 1999.

I was able to make phone contact with MATTHEW, and he told me that he did in fact have the radiator and he believed it was the starter replaced in January of 1999. MATTHEW thought that the truck was in the shop over the weekend of the hit-and-run; however, he later informed me, on 12/14/99, that the truck had been at the repair shop around the 21st of January. At that time Jay's Super Service took care of the repairs.

Based on all the info. gathered on this incident and the fact that there was no significant damage to the vehicle and the parts appearing to be original, no further follow-up will need to be done on this incident. JJost *Jost* /jml

1. CASE # S99 No 09920 2. CLASSIFICATION 6,310,1 3. CENSUS

4. INCIDENT CS/S99-00242

5. INCIDENT LOCATION

6. NAME- LAST, FIRST, MI 7. D.O.B.

8. ADDRESS 9. TX-HOME

STATE ZIP 10. TX-BUSINESS

12. DETAILS

14. REC'D 15. DISP 16. 10-23 17. 10-24
13. DAY
SUN 1 THU 5
MON 2 FRI 6
TUE 3 SAT 7
WED 4

MANITOWOC COUNTY SHERIFF
INCIDENT CARD

18. ASSIGNED
J. Kocourek
6/20/99 417

19. REC. BY *THK* 20. DIS. BY

21. HOW REC'D.
1. 911
2. POLICE RADIO
3. PHONE
4. TTY
5. IN PERSON
6. ON VIEW
7. OFF. OFF DUTY
8. C.B. RADIO
9. OTHER

22. TYPE OF REPORT
1. INCIDENT
2. ACCIDENT
3. CITATION
4. NONE

23. STATUS
1. UNFOUNDED
2. PNL
3. OTHER
4. CLEARED
5. EXCEPT CLEARED

24. DATE CLEARED

25. OFFENSE TYPE
1. ADULT NA
2. JUVENILE
3. UNKNOWN

39. (CODE S-SUSPECT W-WITNESS V-VICTIM O-OTHER)

CODE	40. NAME-LAST	FIRST	MI	41. D.O.B.	42. ADDRESS	43. TELEPHONE

Complainant contacted me at home advising that she had information that might identify the driver of the hit & run vehicle that struck and killed RICK HOCHSTETLER on 1/10/99. **JUVENILE INFO REDACTED**

Complainant states that the alleged suspect vehicle was recently sold to [REDACTED] of [REDACTED]. The vehicle in question is an older model Chevrolet Truck that has recently been repainted and possibly had front end work done on it. Reportedly there was damage to the hood and front bumper.

The person who would have owned this vehicle at the time of the hit and run would be MATTHEW M. KOUBA, DOB [REDACTED] MTSO records indicate MATTHEW lives at [REDACTED] South 20th Street, Manitowoc and has a phone number of [REDACTED]

Another Crimestopper report shows that MATTHEW was also called in as a suspect in a bomb threat investigation at Mirro on 05/24/99. He was a suspect in that investigation because of recently having his employment with that company terminated. Information in that Crimestopper indicated he drove an older model red and cream color Chevy pickup truck. *T. Kocourek* T. Kocourek

S99 No 09920

45. IF COMPLAINANT DIFFERENT THEN CALLER, ENTER NAME, ADDRESS, D.O.B., TELEPHONE.

46. IF CODE O (OTHER) IS USED IN FIELD #39, EXPLAIN.

INCIDENT REPORT: NOTE: IF SECTION 22 ABOVE HAS NUMBER 4 CHECKED, DO NOT GO BEYOND THIS LINE WITHOUT RECORDS SECTION BEING ADVISED, OR NO RECORD ENTRIES WILL BE MADE BELOW THIS LINE.

PROPERTY VALUE	26. PROPERTY	A. CURRENCY	B. JEWELRY	C. FURS CLOTHING	D. VEHICLE (LOCAL)	E. OFFICE EQUIPMENT	F. RADIO, TV CAMERAS	G. FIREARMS	H. HOUSE-HOLD GOODS
	STOLEN	\$	\$	\$	\$	\$	\$	\$	\$
	RECOVERED	\$	\$	\$	\$	\$	\$	\$	\$
	26. PROPERTY	I. CONSUM-ABLES	J. LIVESTOCK	K. DRUGS	L. MARINE ITEMS	M. CONSTRUCTION ITEMS	N. LAWN AND GARDEN	O. SPORTING GOODS	P. MISC BICYCLE
STOLEN	\$	\$	\$	\$	\$	\$	\$	\$	
RECOVERED	\$	\$	\$	\$	\$	\$	\$	\$	

27. PROPERTY RECOVERED: LOCALLY _____ OTHER JURISDICTION _____ (INSERT O OR L)

PROPERTY ITEMIZATION	PROPERTY STOLEN/RECOVERED ITEMIZATION, USE THE FOLLOWING FORMAT			
	28. QUANTITY	29. ARTICLE NAME	30. BRAND NAME	31. SERIAL NUMBER
				S R <input type="checkbox"/> <input type="checkbox"/>
		JUVENILE INFO REDACTED		S R <input type="checkbox"/> <input type="checkbox"/>
				S R <input type="checkbox"/> <input type="checkbox"/>
				S R <input type="checkbox"/> <input type="checkbox"/>
				S R <input type="checkbox"/> <input type="checkbox"/>
				S R <input type="checkbox"/> <input type="checkbox"/>

33. PROPERTY DAMAGE AMOUNT \$ _____

34. INSURANCE COMPANY _____

35. OFFICER ASSAULTED Y N 36. ARSON Y N 37. STRUCTURE CODE _____ 38. DAMAGE \$ _____

47. CIB ENTERED CANCELLED
 NCIC
 OTHER BROADCAST

48. TOTAL AMOUNT PROPERTY STOLEN \$ _____

49. TOTAL AMOUNT PROPERTY RECOVERED \$ _____

50. IS REPORT CONTINUED? YES NO

51. CAUTION INDICATORS, ATLS ETC.

52. DATA PROCESS INFORMATION:

COMPUTER ENTERED DATE
 MICROFILM INDEXED INITIAL _____

53. FILE APPROVAL

IS CASE CLASSIFICATION CORRECT? Y N
 IF N HAS CORRECTION BEEN MADE? Y N

BY _____ DATE

1. CASE # S99 No. 10009 2. CLASSIFICATION 6301 3. CENSUS 10000

4. INCIDENT CS/S99-00242

5. INCIDENT-LOCATION

6. NAME- LAST-FIRST-MI Anon. (2) 7. D.O.B.

8. ADDRESS 9. TX-HOME

11. CITY STATE ZIP 10. TX-BUSINESS

12. DETAILS
see attached worksheet.

0040 120699

MANITOWOC COUNTY SHERIFF
INCIDENT CARD

18. ASSIGNED: MTSO 929
Jost 449

19. REC. BY: JHA	20. DIS. BY: —	22. TYPE OF REPORT 1. INCIDENT 2. ACCIDENT 3. CITATION 4. NONE
21. HOW REC'D. 1. 911 2. POLICE RADIO 3. PHONE 4. TTY 5. IN PERSON 6. ON VIEW 7. OFF. OFF DUTY 8. C.B. RADIO 9. OTHER		23. STATUS 1. UNFOUNDED 2. PNL 3. OTHER 4. CLEARED 5. EXCEPT CLEARED
24. DATE CLEARED: 11/23/99		25. OFFENSE TYPE 1. ADULT <input type="checkbox"/> NA <input type="checkbox"/> 2. JUVENILE <input type="checkbox"/> 3. UNKNOWN <input type="checkbox"/>
21A. M.O.		

14. REC'D	15. DISP	16. 10-23	17. 10-24
13. DAY			
SUN 1	THU 5		
MON 2	FRI 6		
TUE 3	SAT 7		
WED 4			

39. (CODE S-SUSPECT W-WITNESS V-VICTIM O-OTHER)				41. D.O.B.		42. ADDRESS		43. TELEPHONE	
CODE	40. NAME-LAST	FIRST	MI						

12/06/99: I, Deputy Jost, received info. from State Patrol Officer Verbruggen from District 3 State Patrol. He informed me that he had received a second phone call from the anonymous informant regarding our hit-and-run vehicle with a correct RP number. The first RP number given was LKU935; however, the anonymous party now indicated it was LKU955, as she saw the vehicle again. This plates came back to 1992 Chevy truck, registering to a JAMES SIMON out of Green Bay. Prior to having anybody from Green Bay Police Dept. check on the vehicle, I contacted the anonymous complainant again and questioned her whether or not this vehicle was the full-size Chevy blazer, or the S10/mid-size Chevy blazer. She informed me that she remembers it was a 4 door and that it was a late 80s early 90s model, gray in color.

I questioned her if it would have been the same size as a Yukon or Tahoe, and she told me that it was not, that it would have been the mid-size model, and the example being used was a Ford Explorer size model. The anonymous complainant told me that would have been the style vehicle she saw.

Based on this info., I do not feel this vehicle needs to be inspected any further.
JJost /jml

CASE # S99 No. 10009

45. IF COMPLAINANT DIFFERENT THEN CALLER, ENTER NAME, ADDRESS, D.O.B., TELEPHONE.

46. IF CODE O (OTHER) IS USED IN FIELD #39, EXPLAIN.

INCIDENT REPORT: NOTE: IF SECTION 22 ABOVE HAS NUMBER 4 CHECKED, DO NOT GO BEYOND THIS LINE WITHOUT RECORDS SECTION BEING ADVISED, OR NO RECORD ENTRIES WILL BE MADE BELOW THIS LINE.

PROPERTY VALUE	26. PROPERTY	A. CURRENCY	B. JEWELRY	C. FURS CLOTHING	D. VEHICLE (LOCAL)	E. OFFICE EQUIPMENT	F. RADIO, TV CAMERAS	G. FIREARMS	H. HOUSE-HOLD GOODS
	STOLEN	\$	\$	\$	\$	\$	\$	\$	\$
	RECOVERED	\$	\$	\$	\$	\$	\$	\$	\$
	26. PROPERTY	I. CONSUMABLES	J. LIVESTOCK	K. DRUGS	L. MARINE ITEMS	M. CONSTRUCTION ITEMS	N. LAWN AND GARDEN	O. SPORTING GOODS	P. MISC BICYCLE
STOLEN	\$	\$	\$	\$	\$	\$	\$	\$	
RECOVERED	\$	\$	\$	\$	\$	\$	\$	\$	

27. PROPERTY RECOVERED: LOCALLY _____ OTHER JURISDICTION _____ (INSERT O OR L)

PROPERTY ITEMIZATION	PROPERTY STOLEN/RECOVERED ITEMIZATION, USE THE FOLLOWING FORMAT				
	28. QUANTITY	29. ARTICLE NAME	30. BRAND NAME	31. SERIAL NUMBER	
					S <input type="checkbox"/> R <input type="checkbox"/>
					S <input type="checkbox"/> R <input type="checkbox"/>
					S <input type="checkbox"/> R <input type="checkbox"/>
					S <input type="checkbox"/> R <input type="checkbox"/>

33. PROPERTY DAMAGE AMOUNT \$ _____

34. INSURANCE COMPANY _____

35. OFFICER ASSAULTED Y N 36. ARSON Y N 37. STRUCTURE CODE _____ 38. DAMAGE \$ _____

47. CIB ENTERED CANCELLED
 NCIC
 OTHER BROADCAST

48. TOTAL AMOUNT PROPERTY STOLEN \$ _____

49. TOTAL AMOUNT PROPERTY RECOVERED \$ _____

50. IS REPORT CONTINUED? YES NO

51. CAUTION INDICATORS, ATLS ETC.

52. DATA PROCESS INFORMATION:

COMPUTER ENTERED DATE 1/20/99
 MICROFILM INDEXED INITIAL AS

53. FILE APPROVAL

IS CASE CLASSIFICATION CORRECT? Y N
 IF N HAS CORRECTION BEEN MADE? Y N

BY OK DATE 1/23/99

1. CASE # S99 No 10125		2. CLASSIFICATION 6.310.11		3. CENSUS 7,010,000	
4. INCIDENT CS/S99-00242					
5. INCIDENT LOCATION GREEN BAY					
6. NAME - LAST - FIRST - MI ANONYMOUS				7. D.O.B.	
8. ADDRESS			9. TX-HOME		
11. CITY		STATE		ZIP	
10. TX-BUSINESS					
12. DETAILS INFO REC'D FROM MTPD LT. ANDERSON FROM HER E-MAIL OF POSSIBLE SUSPECT.					

MANITOWOC COUNTY SHERIFF INCIDENT CARD					
18. ASSIGNED Jost 4419 MT 50 9889					
19. REC. BY 932		20. DIS. BY		22. TYPE OF REPORT ① INCIDENT ② ACCIDENT ③ CITATION ④ NONE	
21. HOW REC'D. 1. 911 2. POLICE RADIO ③ PHONE 4. TTY 5. IN PERSON 6. ON VIEW 7. OFF. OFF DUTY 8. C.B. RADIO 9. OTHER			23. STATUS 1. UNFOUNDED 2. PNL ③ OTHER 4. CLEARED 5. EXCEPT CLEARED		
14. REC'D			15. DISP		
16. 10-23			17. 10-24		
13. DAY SUN 1 THU 5 MON 2 FRI 6 TUE 3 SAT 7 WED ④					
24. DATE CLEARED 12/11/99			25. OFFENSE TYPE 1. ADULT <input type="checkbox"/> NA <input type="checkbox"/> 2. JUVENILE <input type="checkbox"/> 3. UNKNOWN <input type="checkbox"/>		

39. (CODE S-SUSPECT W-WITNESS V-VICTIM O-OTHER)						
CODE	40. NAME-LAST	FIRST	MI	41. D.O.B.	42. ADDRESS	43. TELEPHONE
0	LYND	RALEIGH (aka DAVE)	D		Deceased	
0	LYND	RUTH	A		N Locust St, Green Bay 54303	
0						

12/01/99 @ 1813 Hrs.: I, Deputy Jost, made phone contact with [redacted] reference a Crime Stopper complaint on the fatal hit and run of RICK HOCHSTETLER. In speaking with [redacted] he told me he had his wife send an E-mail message to several depts. in our area reference information on the hit and run. I originally received this information from MTPD Lt. B. Anderson. She gave me the phone number where I could contact [redacted]

[redacted] informed he was somewhat suspicious about [redacted] death/suicide. He identified [redacted] as RALEIGH (aka DAVE) LYND. [redacted] told me RALEIGH committed suicide on 06/14/99, Flag Day. According to [redacted] he last spoke with RALEIGH approximately 2 years ago; however, he was aware he had some physical problems that were going to need surgery to repair. The surgery needed was apparently to his knees and also the fact that he had an aneurysm on his aorta. According to [redacted] RALEIGH reportedly shot himself due to the physical problems he was having. [redacted] told me he did not believe this was the case and stated he believes [redacted] killed himself for something more serious than just the physical problems.

[redacted] went on to tell me a friend of RALEIGH'S, first name of TOM, apparently had been in the hospital and was on life support sometime in the past. According to [redacted] TOM apparently asked RALEIGH to bring a gun to the hospital as TOM did not want to suffer like he was any more. [redacted] stated RALEIGH made the comment at one time that he wishes he would have brought the gun to TOM so that he would not have suffered. RALEIGH also made the comment that he would never suffer like that.

I questioned [redacted] regarding the possibility that RALEIGH might have been involved in this particular accident. [redacted] told me RALEIGH had apparently owned a business and sold the business. The business was apparently that he was to pick up old 5-gallon buckets and then resell them to people. [redacted] went on to advise that RALEIGH owned a Chevrolet Suburban, and this is what made him suspicious about the whole incident. [redacted] indicated he is not for certain whether or not they owned the Suburban at the time of the 10-50; however, he wished for us to check into it. [redacted] stated to me several times that he just did not believe RALEIGH would kill himself just because of his own physical problems.

CASE # S99 No 10125

45. IF COMPLAINANT DIFFERENT THEN CALLER, ENTER NAME, ADDRESS, D.O.B., TELEPHONE.

46. IF CODE O (OTHER) IS USED IN FIELD #39, EXPLAIN.

INCIDENT REPORT: NOTE: IF SECTION 22 ABOVE HAS NUMBER 4 CHECKED, DO NOT GO BEYOND THIS LINE WITHOUT RECORDS SECTION BEING ADVISED, OR NO RECORD ENTRIES WILL BE MADE BELOW THIS LINE.

PROPERTY VALUE	26. PROPERTY	A. CURRENCY	B. JEWELRY	C. FURS CLOTHING	D. VEHICLE (LOCAL)	E. OFFICE EQUIPMENT	F. RADIO, TV CAMERAS	G. FIREARMS	H. HOUSE-HOLD GOODS
	STOLEN	\$	\$	\$	\$	\$	\$	\$	\$
	RECOVERED	\$	\$	\$	\$	\$	\$	\$	\$
	26. PROPERTY	I. CONSUM-ABLES	J. LIVESTOCK	K. DRUGS	L. MARINE ITEMS	M. CONSTRUCTION ITEMS	N. LAWN AND GARDEN	O. SPORTING GOODS	P. MISC BICYCLE
	STOLEN	\$	\$	\$	\$	\$	\$	\$	\$
	RECOVERED	\$	\$	\$	\$	\$	\$	\$	\$

27. PROPERTY RECOVERED: LOCALLY _____ OTHER JURISDICTION: _____ (INSERT O OR L)

PROPERTY ITEMIZATION	PROPERTY STOLEN/RECOVERED ITEMIZATION, USE THE FOLLOWING FORMAT				
	28. QUANTITY	29. ARTICLE NAME	30. BRAND NAME	31. SERIAL NUMBER	32. CODE
					S <input type="checkbox"/> R <input type="checkbox"/>
					S <input type="checkbox"/> R <input type="checkbox"/>
					S <input type="checkbox"/> R <input type="checkbox"/>
					S <input type="checkbox"/> R <input type="checkbox"/>

33. PROPERTY DAMAGE AMOUNT \$ _____ 34. INSURANCE COMPANY _____

35. OFFICER ASSAULTED Y N 36. ARSON Y N 37. STRUCTURE CODE _____ 38. DAMAGE \$ _____

47. CIB <input type="checkbox"/> ENTERED <input type="checkbox"/> CANCELLED <input type="checkbox"/>	48. TOTAL AMOUNT PROPERTY STOLEN \$ _____
NCIC <input type="checkbox"/>	
OTHER BROADCAST <input type="checkbox"/>	49. TOTAL AMOUNT PROPERTY RECOVERED \$ _____

50. IS REPORT CONTINUED? YES NO 51. CAUTION INDICATORS, ATLS ETC.

52. DATA PROCESS INFORMATION:

COMPUTER ENTERED DATE 12/16/99

MICROFILM INDEXED INITIAL KS

IS CASE CLASSIFICATION CORRECT? (Y) N

IF N HAS CORRECTION BEEN MADE? (Y) N

53. FILE APPROVAL BY [Signature] DATE 12/16/99

MCSO 028 1/91

MANITOWOC COUNTY SHERIFF'S DEPARTMENT
FOLLOW-UP REPORT

Page: 2

CASE NUMBER: 599-10125 CLASSIFICATION: _____

INCIDENT: _____

DATE AND TIME: _____

REPORT CONTINUED:

I, Deputy Jost, questioned [REDACTED] further as to why he believed this might have happened. [REDACTED] told me RALEIGH would apparently drive to Manitowoc on occasion to an unknown business to pick up these buckets. [REDACTED] stated he has no idea whether or not RALEIGH would have been in the Manitowoc area on the date of the accident; however, he felt it needed to be checked into.

[REDACTED] made the comment that one of RALEIGH'S daughters had apparently been killed in a car accident. [REDACTED] felt if RALEIGH would have been involved in this hit and run, this would have been something of a serious enough nature that RALEIGH would have killed himself.

[REDACTED] also felt it was odd that RALEIGH gave his golf cart away to a subject who just repaired it. [REDACTED] stated RALEIGH was an avid golfer, and he felt this was odd that he would just give it away.

According to [REDACTED], RALEIGH had prior knee surgery, and he was scheduled to have knee surgery again in June. [REDACTED] also made the statement that he felt RALEIGH may have been involved as he was a very poor driver. [REDACTED] brought up his poor driving to RALEIGH several times.

12/11/99 @ 1300 Hrs.: Based on all the information [REDACTED] gave me and the fact that he told me I could contact RALEIGH'S wife, RUTH LYND, I made contact with her on this date and time. I spoke with RUTH and questioned her specifically about the vehicles they had previously owned. Several 10-28s/DOT checks are attached to this report reference the vehicles they own. I specifically questioned RUTH about a 1993 truck that they owned. She told me she sold this vehicle at the end of June, beginning of July after RALEIGH killed himself. RUTH told me this vehicle was an S10 model truck, so it does not appear that vehicle matches.

I questioned RUTH about the Suburban they previously owned. She told me I was probably referring to the 1977 truck that they had owned. RUTH told me this was lighter green vehicle; however, they sold it 6 months prior to March 1998. RUTH specifically told me she believes it was around that time as they got a renewal bill from DOT after they sold the vehicle which indicated they needed to renew their registration as of March 1998; however, again, she told me they sold the vehicle approximately 6 months prior to this. Apparently, the person they sold the vehicle did not transfer the RPs.

Based on the information I gathered from RUTH, I do not believe RALEIGH was involved in this 10-50 as the statements made by [REDACTED] indicated RALEIGH had probably committed suicide because of his own physical problems. This information was not brought up with RUTH as the vehicle descriptions did not match the vehicles we are currently looking for. Not only did the vehicles not match the description, but they sold the vehicles prior to this. That information coincided with the 10-28s I ran.

I do not believe any further follow-up needs to be done reference this Crime Stopper.

JMJost *[Signature]* /bjc

MANITOWOC COUNTY SHERIFF'S DEPARTMENT
FOLLOW-UP REPORT

Page: 3

CASE NUMBER: 599-10125 CLASSIFICATION: _____

INCIDENT: _____

DATE AND TIME: _____

REPORT CONTINUED:

O WOUTERS ANTHONY P [REDACTED] [REDACTED] Dousman St, Green Bay [REDACTED]

12/13/99 @ 1955 Hrs.: I, Deputy Jost, received a phone call from ANTHONY WOUTERS reference the message I left on his answering machine. WOUTERS told me he checked with the service man who used to work on RALEIGH and RUTH LYND'S truck and found the service man believes the Suburban they used to own was a 1979 model. WOUTERS also told me he knows that RALEIGH and RUTH also own a Ford Ranger pickup truck and a Chevy S10 pickup truck.

Based on all the information gathered on this report, I believe this report can be closed as it does not appear to be related to the fatal hit and run. JMJost /bjc

1. CASE # S99 No 10068 2. CLASSIFICATION 0391 3. CENSUS 52000

4. INCIDENT CS / S99-00242

5. INCIDENT LOCATION Jay /

6. NAME- LAST - FIRST - MI [REDACTED] 65136

8. ADDRESS [REDACTED]

11. CITY 1200 Rivers STATE ZIP 10. TX-BUSINESS

12. DETAILS Info reference for letter case.

1229 120899
 1313
 1331
 REC'D. 14. 15. 16. 17.
 DISP 10-23 10-24
 13. DAY
 SUN 1 THU 5
 MON 2 FRI 6
 TUE 3 SAT 7
 WED 4

MANITOWOC COUNTY SHERIFF
 INCIDENT CARD

18. ASSIGNED Colborn 4/312
 Riddle 4/517

19. REC. BY 20. DIS. BY 22. TYPE OF REPORT
 1. INCIDENT
 2. ACCIDENT
 3. CITATION
 4. NONE

21. HOW REC'D.
 1. 911
 2. POLICE RADIO
 3. PHONE
 4. TTY
 5. IN PERSON
 6. ON VIEW
 7. OFF. OFF DUTY
 8. C.B. RADIO
 9. OTHER

23. STATUS
 1. UNFOUNDED
 2. PNL
 3. OTHER
 4. CLEARED
 5. EXCEPT CLEARED

24. DATE CLEARED 11/21/099

25. OFFENSE TYPE
 1. ADULT NA
 2. JUVENILE
 3. UNKNOWN

39. (CODE S-SUSPECT W-WITNESS V-VICTIM O-OTHER)	40. NAME- LAST	FIRST	MI	41. D.O.B.	42. ADDRESS	43. TELEPHONE
W	JOHNSON	JENNIFER	L	[REDACTED]	Lincoln St. Two Rivers	[REDACTED]
O	[REDACTED]	[REDACTED]	[REDACTED]	[REDACTED]	[REDACTED]	[REDACTED]

12/08/99 @ 1331 Hrs.: I, Deputy A. Colborn, responded to APPLE MEDICAL CLINIC located at [REDACTED] Jay St, Manitowoc. Preliminary information received from MTSO Dispatch was that employees of APPLE MEDICAL CLINIC contacted them and informed them that they information regarding incident S99-00242.

Upon arrival, I made contact with JENNIFER JOHNSON who identified herself as an employee of APPLE MEDICAL CLINIC. I also made contact with 2 other employees who at this time wished to remain anonymous. I was informed by these employees that [REDACTED] is currently a patient who undergoes [REDACTED] at their clinic. I was informed by JOHNSON that last week, [REDACTED] who is normally a very joking and boisterous-type individual came into the clinic "down in the dumps." The employees stated [REDACTED] seemed unusually quiet and withdrawn. The employees stated they did not remember the exact date of this incident but stated it was shortly after my interview with CHANNEL 11 NEWS reference FBI involvement in the fatal hit and run involving RICK HOCHSTETLER.

One employee stated she asked [REDACTED] if he was having problems with his wife. [REDACTED] stated his problem was not a marital issue but that he was "in trouble." JOHNSON stated, later when [REDACTED] was [REDACTED], he made the comment he was "in big trouble." JOHNSON and the other 2 employees stated [REDACTED] made the comment, "My van fits the description of the one that hit that boy perfectly, but nobody's come out to check it."

The employees informed me [REDACTED] drives a light brown/tan-colored Chevrolet van but to date, no one has been able to check the front end or see the front end for damage. All employees stated [REDACTED] was not intoxicated when he made these comments. The employees stated they have never observed [REDACTED] to be intoxicated, but [REDACTED] does make comments that he frequents taverns in the local area. I was informed [REDACTED] resides in the Village of Valders behind SAM'S SUPPER CLUB.

I responded to Valders where I located [REDACTED]'S residence. Sitting in front of his residence, I observed a tan Chevrolet van bearing WI RP NEX750. It should be noted a check of this RP through WI DOT revealed it was assigned to a 1984 Chevrolet belonging to [REDACTED] and [REDACTED].

S99 No 10068

45. IF COMPLAINANT DIFFERENT THEN CALLER, ENTER NAME, ADDRESS, D.O.B., TELEPHONE.

46. IF CODE O (OTHER) IS USED IN FIELD #39, EXPLAIN.

INCIDENT REPORT: NOTE: IF SECTION 22 ABOVE HAS NUMBER 4 CHECKED, DO NOT GO BEYOND THIS LINE WITHOUT RECORDS SECTION BEING ADVISED, OR NO RECORD ENTRIES WILL BE MADE BELOW THIS LINE.

PROPERTY VALUE	26. PROPERTY	A. CURRENCY	B. JEWELRY	C. FURS CLOTHING	D. VEHICLE (LOCAL)	E. OFFICE EQUIPMENT	F. RADIO, TV CAMERAS	G. FIREARMS	H. HOUSE-HOLD GOODS
	STOLEN	\$	\$	\$	\$	\$	\$	\$	\$
	RECOVERED	\$	\$	\$	\$	\$	\$	\$	\$
	26. PROPERTY	I. CONSUM-ABLES	J. LIVESTOCK	K. DRUGS	L. MARINE ITEMS	M. CONSTRUCTION ITEMS	N. LAWN AND GARDEN	O. SPORTING GOODS	P. MISC BICYCLE
STOLEN	\$	\$	\$	\$	\$	\$	\$	\$	
RECOVERED	\$	\$	\$	\$	\$	\$	\$	\$	

27. PROPERTY RECOVERED: LOCALLY ____ OTHER JURISDICTION ____ (INSERT O OR L)

PROPERTY ITEMIZATION	PROPERTY STOLEN/RECOVERED ITEMIZATION, USE THE FOLLOWING FORMAT				31. SERIAL NUMBER	32. CODE
	28. QUANTITY	29. ARTICLE NAME	30. BRAND NAME			
						S R <input type="checkbox"/> <input type="checkbox"/>
						S R <input type="checkbox"/> <input type="checkbox"/>
						S R <input type="checkbox"/> <input type="checkbox"/>
						S R <input type="checkbox"/> <input type="checkbox"/>
						S R <input type="checkbox"/> <input type="checkbox"/>
						S R <input type="checkbox"/> <input type="checkbox"/>

33. PROPERTY DAMAGE AMOUNT \$ _____ 34. INSURANCE COMPANY _____

35. OFFICER ASSAULTED Y N 36. ARSON Y N 37. STRUCTURE CODE _____ 38. DAMAGE \$ _____

47. CIB	ENTERED <input type="checkbox"/>	CANCELLED <input type="checkbox"/>	48. TOTAL AMOUNT PROPERTY STOLEN \$ _____
NCIC	<input type="checkbox"/>	<input type="checkbox"/>	
OTHER BROADCAST	<input type="checkbox"/>	<input type="checkbox"/>	
			49. TOTAL AMOUNT PROPERTY RECOVERED \$ _____

50. IS REPORT CONTINUED? YES NO 51. CAUTION INDICATORS, ATLS ETC.

52. DATA PROCESS INFORMATION:

COMPUTER ENTERED DATE 12/10/99

MICROFILM INDEXED INITIAL *AS*

IS CASE CLASSIFICATION CORRECT? IF N HAS CORRECTION BEEN MADE? Y N

53. FILE APPROVAL

BY *R* DATE 12/10/99

MANITOWOC COUNTY SHERIFF'S DEPARTMENT
FOLLOW-UP REPORT

Page: 2

CASE NUMBER: 599-10068 CLASSIFICATION: _____

INCIDENT: _____

DATE AND TIME: _____

REPORT CONTINUED:

I, Deputy Colborn, made contact with [REDACTED]. I was informed this is the only Chevrolet van that he owns. I observed the vehicle RP did match the RP supplied to us by DOT. This showed the RP was on the correct vehicle. I observed one headlight bezel on the vehicle to be missing and the windshield to be cracked; however, I observed the hood was free of dents as well as the upper radiator support. I further observed the fan shroud was intact. I observed the front bumper did not appear to have been replaced and was also free of damage as was the main grill insert portion.

I took 3 Polaroid pictures of the van (see attached). I asked [REDACTED] where the vehicle was on the day incident S99-00242 occurred. [REDACTED] stated the van was in storage at Chilton at that time. [REDACTED] stated he just recently brought the vehicle out of storage to begin using it as a work vehicle.

At this time, this vehicle does not appear to be the suspect vehicle for incident S99-00242. A copy of this incident should be forwarded to Det. Michel and incident commander, Lt. M. Bushman, for their review.

No further action taken at this time. ALColborn /bjc

12/09/99: Forwarded a copy of this report to Det. Michel and Lt. M. Bushman per Deputy Colborn. BJChristianson *bjc*

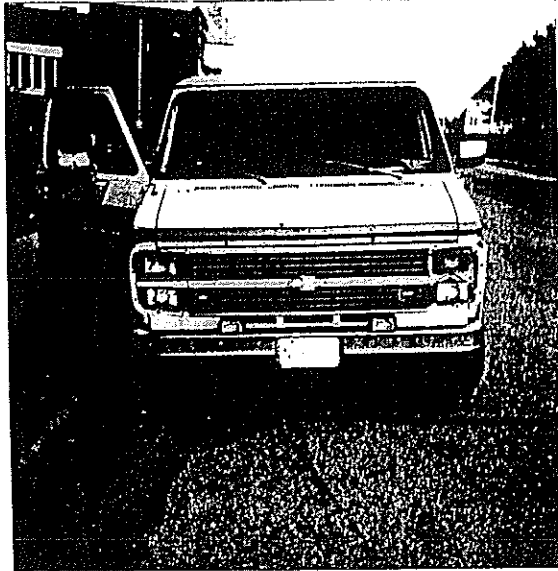

12/08/99 @ 1535 HRS S99-10068 a/c #432



12/08/99 @ 1535 HRS S99-10068 a/c #432

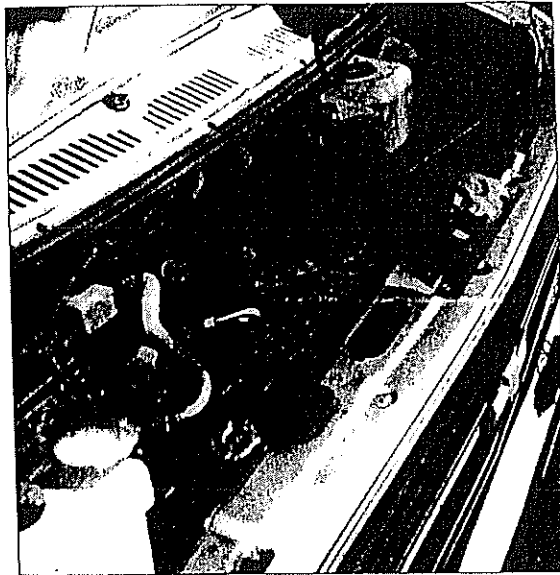

12/08/99 @ 1535 HRS S99-10068 a/c #432

1. CASE # **S99 No 09837** 2. CLASSIFICATION **6,3|0,1|** 3. CENSUS **7,0|0,0,0**

4. INCIDENT **CRIMESTOPPER 399-00242**

5. INCIDENT LOCATION **STURGEON BAY**

6. NAME- LAST-FIRST-MI **ANONYMOUS** 7. D.O.B.

8. ADDRESS 9. TX-HOME

11. CITY STATE ZIP 10. TX-BUSINESS

12. DETAILS
 Received info from female that worked at Country Kitchen in Sturgeon Bay, around the time of the H & R. She states that at that time Country Kitchen was opened yet, all night in early January, m/w drove across the lawn and did cause damage at the restaurant, and Sturgeon Bay PD was called to the scene.

0945 113099
 STB
 14. REC'D. 15. DISP. 16. 10-23 17. 10-24
 13. DAY
 MON 1 THU 5
 MON 2 FRI 6
 TUE 3 SAT 7
 WED 4

MANITOWOC COUNTY SHERIFF INCIDENT CARD

18. ASSIGNED
 Lt. Bushman 41411

19. REC. BY **922** 20. DIS. BY **922**
 22. TYPE OF REPORT
 INCIDENT
 ACCIDENT
 CITATION
 NONE

21. HOW REC'D.
 1. 911
 2. POLICE RADIO
 3. PHONE
 4. TTY
 5. IN PERSON
 6. ON VIEW
 7. OFF. OFF DUTY
 8. C.B. RADIO
 9. OTHER

23. STATUS
 1. UNFOUNDED
 2. PNL
 3. OTHER
 4. CLEARED
 5. EXCEPT CLEARED
 24. DATE CLEARED **11/21/99**
 25. OFFENSE TYPE
 1. ADULT NA
 2. JUVENILE
 3. UNKNOWN

39. (CODE S-SUSPECT W-WITNESS V-VICTIM O-OTHER)				41. D.O.B.		42. ADDRESS		43. TELEPHONE	
CODE	40. NAME-LAST	FIRST	MI						
0	MANNO	Michael	P	[REDACTED]		[REDACTED] Shiloh Rd, Sturgeon Bay 54235			

Vehicle was a Blazer, blue or black in color with alot of front end damage. According to caller, the Police did make a report. Caller states she thought the suspects name was Michael NANO.(unknown if correct spelling). TTY sent to Sturgeon Bay Police Department requesting a FAX of said report, if there is a report. LBJ/922 PSJS

12/01/99 0100hrs Contact made by phone with Dispatch at Door County SO. They dispatch for Sturgeon Bay PD through the night. Suspects name is a Michael Mano, very well known to their area, they will attempt to find a accident report and forward to me. Phone and fax information left with them. M.J. Bushman

12/01/99 @ 0145 Hrs.: I, Lt. M. Bushman, received a phone call from Sgt. Gary Rabach from Sturgeon Bay PD. Sgt. Rabach is very familiar with MICHAEL MANNO. The incident which was referred to as taking place at COUNTRY KITCHEN in Sturgeon Bay was an incident that happened on 01/02/99. Apparently, MANNO was "booted" out of COUNTRY KITCHEN, and he went back to demand an apology as he identified himself as a police officer. Eventually, he drove his vehicle across the lawn and left the COUNTRY KITCHEN parking lot. The vehicle he was operating at the time was a black and medium blue Chevrolet Blazer. Sgt. Rabach referred to the vehicle as "winter junk." He could not recall if there was specific grill or hood damage but went on to describe the vehicle as raised quite high with exceptionally large tires. This would not be a match for the type of vehicle we are looking for.

Sgt. Rabach said MANNO would be a good suspect if we good place him in our area as that would be the type of incident he may be involved in. With the incident at COUNTRY KITCHEN, he was charged with Disorderly Conduct and Impersonating a Police Officer. He served his time in the Co. Jail starting in June 1999.

Sgt. Rabach stated, just to give me an idea on the type of individual we are dealing with, on 03/28/99, MANNO again became involved in an argument in a parking lot with an individual. He took his truck, pushed it up against the vehicle, and then pushed the vehicle around the parking lot several times. He left prior to police arriving; however, they located him within a relatively short...

CASE # **S99**
 No **09837**
 09

70000 011

45. IF COMPLAINANT DIFFERENT THEN CALLER, ENTER NAME, ADDRESS, D.O.B., TELEPHONE.

46. IF CODE O (OTHER) IS USED IN FIELD #39, EXPLAIN.

INCIDENT REPORT: NOTE: IF SECTION 22 ABOVE HAS NUMBER 4 CHECKED, DO NOT GO BEYOND THIS LINE WITHOUT RECORDS SECTION BEING ADVISED, OR NO RECORD ENTRIES WILL BE MADE BELOW THIS LINE.

PROPERTY VALUE	26. PROPERTY	A. CURRENCY	B. JEWELRY	C. FURS CLOTHING	D. VEHICLE (LOCAL)	E. OFFICE EQUIPMENT	F. RADIO, TV CAMERAS	G. FIREARMS	H. HOUSE-HOLD GOODS
	STOLEN	\$	\$	\$	\$	\$	\$	\$	\$
	RECOVERED	\$	\$	\$	\$	\$	\$	\$	\$
	26. PROPERTY	I. CONSUMABLES	J. LIVESTOCK	K. DRUGS	L. MARINE ITEMS	M. CONSTRUCTION ITEMS	N. LAWN AND GARDEN	O. SPORTING GOODS	P. MISC BICYCLE
	STOLEN	\$	\$	\$	\$	\$	\$	\$	\$
	RECOVERED	\$	\$	\$	\$	\$	\$	\$	\$

27. PROPERTY RECOVERED: LOCALLY _____ OTHER JURISDICTION _____ (INSERT O OR L)

PROPERTY ITEMIZATION	PROPERTY STOLEN/RECOVERED ITEMIZATION, USE THE FOLLOWING FORMAT				
	28. QUANTITY	29. ARTICLE NAME	30. BRAND NAME	31. SERIAL NUMBER	32. CODE
					S <input type="checkbox"/> R <input type="checkbox"/>
					S <input type="checkbox"/> R <input type="checkbox"/>
					S <input type="checkbox"/> R <input type="checkbox"/>
					S <input type="checkbox"/> R <input type="checkbox"/>
					S <input type="checkbox"/> R <input type="checkbox"/>

33. PROPERTY DAMAGE AMOUNT \$ _____

34. INSURANCE COMPANY _____

35. OFFICER ASSAULTED Y N

36. ARSON Y N

37. STRUCTURE CODE _____ 38. DAMAGE \$ _____

47. CIB ENTERED CANCELLED
 NCIC
 OTHER BROADCAST

48. TOTAL AMOUNT PROPERTY STOLEN \$ _____

49. TOTAL AMOUNT PROPERTY RECOVERED \$ _____

50. IS REPORT CONTINUED? YES NO

51. CAUTION INDICATORS, ATLS ETC.

52. DATA PROCESS INFORMATION:

COMPUTER ENTERED DATE 12/3/99
 MICROFILM INDEXED INITIAL KS

53. FILE APPROVAL

IS CASE CLASSIFICATION CORRECT? Y N
 IF N HAS CORRECTION BEEN MADE? Y N

BY QR DATE 12/02/99

MANITOWOC COUNTY SHERIFF'S DEPARTMENT
FOLLOW-UP REPORT

Page: 2

CASE NUMBER: 509-09837 CLASSIFICATION: _____

INCIDENT: _____

DATE AND TIME: _____

REPORT CONTINUED:

The faxed copy of the description of the incident and some specific pieces of evidence on our hit and run were forwarded to Sgt. Rabach. He stated he would personally go and check the van out which is parked at MANNO'S residence outside overnight. If there is anything truly consistent with what we are looking for, he will call us back.

It sounds doubtful this would be the vehicle involved as Sgt. Rabach was talking to a second individual, attempting to get a full description of the vehicle. Because of the height of the vehicle and the type of tires which were definitely observed in a short period of time before the accident on the vehicle and shortly after the accident, finding they were consistent both times, it is doubtful MANNO is involved in this incident.

Sgt. Rabach decided to go and make one final check himself. If anything is out of place or appears as though it belongs to our hit and run, he will call me back. I do not anticipate him calling back.

A faxed copy of MANNO'S contact sheet from Sturgeon PD and his 10-27 are attached.
MJBushman  /bjc

Sturgeon Bay Police Department

S. 5th Avenue
Sturgeon Bay, WI 54235
Tel
Fax

FAX COVER SHEET

DATE: 11-30-99
TO: Mount S.O.
ATTN: Lt Shorrington
FROM: Jennie - SBPD
SUBJECT: Accdt. - Jan '99 - Country Kitchens Rest.
DESTINATION FAX #: [redacted] - [redacted] - [redacted]
NUMBER OF PAGES: 1
(Including Cover Sheet)

MESSAGE: Can't locate an accdt at this location. Do you have a name or other info?

Thanks

NOT INVOLVED IN ACC

01 or 99 BOOTED OUT OF CO. KIT HE SAID HE SAID
~~HE CALL A POLICE OFFICER~~ CHANGED w/ IN THE STREET
P.O OFFICER
BLK / MED BLK CHEV. BEAZER - W/STEN JUNK

MARCH 28 PARKED HIS VEH AGAINST ANOTHER
PULLED IT AROUND 4TH
SGT. GARY LABACH

MICHAEL P. MANN 

JUN 99 LAST CONTACT

THESE GUYS NO GOOD

MAN'S VEH ^{MARCH} PARKED HIGH
LARGE TIRE

Sturgeon Bay Police Department

■ S. 5th Avenue
Sturgeon Bay, WI 54235
Tel (920) ■
Fax (920) ■

FAX COVER SHEET

DATE: 01 DEC 99

TO: LT Buschman - MANITOWOC

ATTN: _____

FROM: SGT G. RABACH - STURGEON BAY P.D.

SUBJECT: MANNO - IN-HOUSE RECORD

DESTINATION FAX #: _____

NUMBER OF PAGES: 02
(Including Cover Sheet)

MESSAGE: _____

This message is intended only for the use of the individual or entity to which it is addressed, and may contain information that is privileged, confidential and exempt from disclosure under applicable law. If the reader of this message is not the intended recipient, the employee, or the agent responsible for delivering the message to the intended recipient, you are hereby notified that any dissemination, distribution or copying of this communication is strictly prohibited. If you receive this communication in error, please notify us immediately by telephone and return the original message to us at the above address via the U.S. Postal Service. Thank you.

1. CASE # S99 No 09841	2. CLASSIFICATION 57181	3. CENSUS 70000
4. INCIDENT INFO / S99-00242		
5. INCIDENT LOCATION Little Chute		
6. NAME - LAST - FIRST - MI FOX VALLEY METRO PD	7. D.O.B.	
8. ADDRESS [REDACTED]		
11. CITY [REDACTED]	STATE [REDACTED]	ZIP [REDACTED]
12. DETAILS Info from citizen regarding possible suspect vehicle from S99-00242 observed today w/new grill + bad paint job, # VCL320.		

1130 99

MANITOWOC COUNTY SHERIFF INCIDENT CARD		
18. ASSIGNED E Bushman		441
Glaeser		417
19. REC. BY 900		20. DIS. BY
21. HOW REC'D. 1. 911 2. POLICE RADIO 3. PHONE 4. TTY 5. IN PERSON 6. ON VIEW 7. OFF. OFF DUTY 8. C.B. RADIO 9. OTHER		22. TYPE OF REPORT 1. INCIDENT 2. ACCIDENT 3. CITATION 4. NONE
23. STATUS 1. UNFOUNDED 2. PNL 3. OTHER 4. CLEARED 5. EXCEPT CLEARED		24. DATE CLEARED 11/21/0699
25. OFFENSE TYPE 1. ADULT <input type="checkbox"/> NA <input type="checkbox"/> 2. JUVENILE <input type="checkbox"/> 3. UNKNOWN <input type="checkbox"/>		

39. (CODE S-SUSPECT W-WITNESS V-VICTIM O-OTHER)	40. NAME-LAST	FIRST	MI	41. D.O.B.	42. ADDRESS	43. TELEPHONE
O	STILTJES	PETER	J	[REDACTED]	Muelemans Rd. Black Creek	
O	OPELT	BRIAN	D	[REDACTED]	Town Hall Rd. Black Creek	
O	OUTAGAMIE CO SHERIFF'S DEPT/SGT HARRIS					

11-30-99 Caller's name is [REDACTED]. Officer Meilinger was advised the shift commander would call him back to advise how to proceed if their assistance was needed. sbraun920
 Incident forwarded to Appleton PD as street in their jurisdiction. Faxed copy of incident sent 0055hrs.M.J.Bushman

12-01-99 @ 0730 hrs.: I, Deputy E. Glaeser, acting on information received from Deputy Inspector Tisler, did contact Outagamie Co. SD, Sgt. Harris, in regards to this incident. Sgt. Harris indicated to me that through a process of several contacts and different agencies, he was requested to check on a veh. that was presently located in the Town of Nichols, WI. The veh. in question was a close match to our suspect hit & run veh. and it was in fact a 1979 Chevy Suburban Truck. Sgt. Harris indicated to me that he had one of his officers presently out with the veh. and he indicated to me that he would relay information in regards to the vehicle's condition and specifics about the condition of the veh.

10-28 that was run on the veh. which was WI RP# VCL320 indicated the owner would be a PETER J. STILTJES from Black Creek area. In speaking to Sgt. Harris of Outagamie Co., he was able to provide a phone # for STILTJES, but he indicated to me that presently STILTJES was not at home, but his officers would attempt to contact him at his place of employment. A short time later, I did receive a telephone call from MR. STILTJES and I requested him in regards to this veh. STILTJES indicated to me that he recently purchased the veh. from a BRIAN OPELT of Black Creek. STILTJES said that OPELT had apparently made the improvements to the veh., that being a paint job, and replacing front end parts on the veh. prior to selling it to STILTJES.

12-01-99 @ 0830 hrs.: I, Deputy E. Glaeser, was again contacted by Sgt. Harris of Outagamie Co. Sheriff's Dept. and he did indicate to me that he had personally contacted BRIAN OPELT in regards to this veh. and made a determination that OPELT had done the repairs to the veh. in question approx. 2 years prior to this date and Sgt. Harris reassured me that he made a verification of the repairs and the time line associated with those repairs. Due to the fact that the veh. was repaired in excess of a year prior to our

No 09841

45. IF COMPLAINANT DIFFERENT THEN CALLER, ENTER NAME, ADDRESS, D.O.B., TELEPHONE.

46. IF CODE O (OTHER) IS USED IN FIELD #39, EXPLAIN.

INCIDENT REPORT: NOTE: IF SECTION 22 ABOVE HAS NUMBER 4 CHECKED, DO NOT GO BEYOND THIS LINE WITHOUT RECORDS SECTION BEING ADVISED, OR NO RECORD ENTRIES WILL BE MADE BELOW THIS LINE.

PROPERTY VALUE	26. PROPERTY	A. CURRENCY	B. JEWELRY	C. FURS CLOTHING	D. VEHICLE (LOCAL)	E. OFFICE EQUIPMENT	F. RADIO, TV CAMERAS	G. FIREARMS	H. HOUSE-HOLD GOODS
	STOLEN	\$	\$	\$	\$	\$	\$	\$	\$
	RECOVERED	\$	\$	\$	\$	\$	\$	\$	\$
	26. PROPERTY	I. CONSUMABLES	J. LIVESTOCK	K. DRUGS	L. MARINE ITEMS	M. CONSTRUCTION ITEMS	N. LAWN AND GARDEN	O. SPORTING GOODS	P. MISC BICYCLE
	STOLEN	\$	\$	\$	\$	\$	\$	\$	\$
	RECOVERED	\$	\$	\$	\$	\$	\$	\$	\$

27. PROPERTY RECOVERED: LOCALLY _____ OTHER JURISDICTION _____ (INSERT O OR L)

PROPERTY ITEMIZATION	PROPERTY STOLEN/RECOVERED ITEMIZATION, USE THE FOLLOWING FORMAT				
	28. QUANTITY	29. ARTICLE NAME	30. BRAND NAME	31. SERIAL NUMBER	
					S R <input type="checkbox"/> <input type="checkbox"/>
					S R <input type="checkbox"/> <input type="checkbox"/>
					S R <input type="checkbox"/> <input type="checkbox"/>
					S R <input type="checkbox"/> <input type="checkbox"/>

33. PROPERTY DAMAGE AMOUNT \$ _____

34. INSURANCE COMPANY _____

35. OFFICER ASSAULTED Y N

36. ARSON Y N

37. STRUCTURE CODE _____

38. DAMAGE \$ _____

47. CIB ENTERED CANCELLED
 NCIC
 OTHER BROADCAST

48. TOTAL AMOUNT PROPERTY STOLEN \$ _____

49. TOTAL AMOUNT PROPERTY RECOVERED \$ _____

50. IS REPORT CONTINUED? YES NO

51. CAUTION INDICATORS, ATLS ETC.

52. DATA PROCESS INFORMATION:

COMPUTER ENTERED DATE 1/25/99
 MICROFILM INDEXED INITIAL AS

IS CASE CLASSIFICATION CORRECT? N
 IF N HAS CORRECTION BEEN MADE? N

53. FILE APPROVAL

BY  DATE 1/21/99

MANITOWOC COUNTY SHERIFF'S DEPARTMENT
FOLLOW-UP REPORT

Page: _____

CASE NUMBER: _____ CLASSIFICATION: _____

INCIDENT: _____

DATE AND TIME: _____

REPORT CONTINUED:

criminal investigation date, this veh. can be eliminated. No further action taken.

EGlaeser/ *EG* klf

4. INCIDENT
Crime-Stoppers Comp# S99-09841

5. INCIDENT LOCATION
Little Chute

6. NAME - LAST - FIRST - MI
Fox Valley Metro PD

7. D.O.B.

8. ADDRESS
9. TX-HOME

10. TX-BUSINESS

11. CITY STATE ZIP

12. DETAILS
Information received of a citizen regarding possible suspect in the Hit and Run S99-00242 Vehicle observed today with New grille and bad paint job, registration VCL 320. Owner: Peter J. Stiltjes [redacted] N. Superior St. Appleton.

INCIDENT CARD

18 ASSIGNED
Lt. Bushman

19. REC. BY
20. DIS. BY

21. HOW REC'D.
1. 911
2. POLICE RADIO
3. PHONE
4. TTY
5. IN PERSON
6. ON VIEW
7. OFF. OFF DUTY
8. C.B. RADIO
9. OTHER

22. TYPE OF REPORT
1. INCIDENT
2. ACCIDENT
3. CITATION
4. NONE

23. STATUS
1. UNFOUNDED
2. PNL
3. OTHER
4. CLEARED
5. EXCEPT CLEARED

24. DATE CLEARED

25. OFFENSE TYPE
1. ADULT NA
2. JUVENILE
3. UNKNOWN

14. REC'D	15. DISP	16. 10-23	17. 10-24
13. DAY			
SUN 1	THU 5		
MON 2	FRI 6		
TUE 3	SAT 7		
WED 4			

39. (CODE S-SUSPECT W-WITNESS V-VICTIM O-OTHER)				41. D.O.B.	42. ADDRESS	43. TELEPHONE
CODE	40. NAME-LAST	FIRST	MI			
0	Stiltjes, Peter J.				[redacted] N. Superior St. Appleton	
	Appleton PD				Fax [redacted]	[redacted]

Manitowoc County SO is investigating a Fatal Hit & Run Accident from 01/10/99 0225hrs on CIH CR South of the City of Manitowoc. CIH CR is roadbed from the Old 141 highway and is currently a frontage road for I-43. Suspect vehicle struck a 17 year old young man walking South on the West shoulder. Victim was then dragged 300 Ft. down the roadway and left to die. Victim was 6'1 210 pounds.

Suspect vehicle is a 1985-1987 (some very early 1988) Chevrolet Pickup, Suburban, K-5 (full size) Blazer or 1989-1991 Chev van. Damage will be extensive to the grill some hood and possibly bumper. There were parts from the engine fan shroud at the scene indicating the radiator support wall was pushed backward turning the shroud into the fan. The radiator did not leak. Damage concentration would be just to the left of center (if facing vehicle front) between the Chevrolet emblem and passenger side headlamp. No glass or lense material found at scene. There may be windshield damage. Vehicle is a low line Chev product like a Custom Deluxe or Scotsdale version, single rectangular semi round headlamp at each side of grill. Vehicle should be standard height, no lift kit, tires 7 1/4 inch wide non aggressive thread, your basic Fleet Farm special.

Request your assistance in checking the above listed vehicle in your area, call MTSO and speak with Lt. Michael J. Bushman for further detail. [redacted] M.J. Bushman

12/01/99 Appleton can you make contact and determine how long owner had the vehicle? Does any of the above information match the damage or repaired area? Get a brief history of the vehicle, current and past owners for this year starting 01/01/99. Snap a picture if your unsure. I work 8PM to 4AM. M.J. Bushman

CASE # S99 # N 01643

12/02/99 Part 1
User: PARKERKL

INCIDENT DETAIL PRINT
OUTAGAMIE COUNTY SHERIFFS DEPARTMENT

99-0145-981 Page 1

SERVICE INFORMATION

Sequence#: 1

How Receive: 02 Telephone District: OU1 Date: 12/01/99 Day: 4 Time: 7:11
Nature.....: AGENCY ASSIST Rcvd by:432 Dispatch by: 429 Shift
Location....: MUELEMAN Apt:
City/State.: CICERO WI

Vehicle Lic: VCL320 Vehicle ID #: State: WI Exp:

Reported by: MANITOWOC COUNTY SHERIFFS DEPT
Location...: 1025 S NINTH STREET Apt:
City/State.: MANITOWOC WI 54220 Sex:

Report Code: 1 Arrests: Disposition: 004 Ref oth agency
ISC.....:9902 Incd Cd: 1 Police Incident CURRENT STATUS INFORMATION
JCR.....: 00 ASSIST OTHER AGENCY INVEST/ETC Unit: 241 Disp Ref oth agency
Mult Calls: as of 12/01/99
Note.....: CHECK FOR HIT AND RUN VEH

ASSIGNED UNITS										
Unit	Name	Jur	Type	Filed	Resp	T	Disp	Arrv	Clrd	Total
241	CLEMENT, ROBERT A. (OU	44	P	F	4		7:24	7:56	9:45	1:49
3	PAMENTER, DANIEL	44	P		4		8:26	8:55	9:39	44
214	HERRES, HARRY	44	P		4		8:55	8:55	9:36	41

Offense Rpt#: 1

CONTACT INFORMATION

----- CONTACT INFORMATION -----

Document: 1 Filed by: 241 Date: 12/01/99

Contact.....: MANITOWOC COUNTY SHERIFFS DEPT D.O.B.: 0/00/00
Address.....: 1025 S NINTH STREET
City/state..: MANITOWOC WI 54220
Sex.....: Race: Phone: [REDACTED]

Contact.....: Report. Person Desc.....: AGENCY ASSIST
Contact Date: 12/01/99 Report No.: 990145981
Report Type.: Offense Report Disp Date.: 12/01/99
Disposition.: Referred to other agency Injury.....:
Actions.....: Victim type:
Circumstance:

Officer Clement reporting:

On 12-01-99 at approximately 6:45AM, I Deputy Robert Clement #241, was given paperwork from Manitowoc County Sheriff's Department regarding a vehicle that was believed to be involved in a fatal hit and run on CTH CR in the County of Manitowoc on 01-10-99 at 2:25AM. The vehicle was described to be a 1985-1987 Chevrolet pickup, Suburban, K-S (full size) Blazer or 1989-1991 Chevrolet van with possible front end damage to the grill, bumper, and possibly the windshield. The suspect vehicle is believed to be owned by Peter J. Stiltjes, m/w, DOB: [REDACTED], with a possible address of [REDACTED] Muelemans Road, Black Creek, WI 54106, in the County of Outagamie.

Upon arrival to [REDACTED] Muelemans Road at 7:56Am, I spoke to Alan J. Stiltjes, m/w, DOB: [REDACTED], phone [REDACTED]. Alan stated to me that Peter, who is his brother, lives in the apartment behind the Dew Drop Inn, [REDACTED] Main Street, Nichols, WI 54152. Alan also stated to me that his brother Peter owns an older model Chevy Suburban which he has only owned for approximately one month. I then went to [REDACTED] Main Street in Village of Nichols to speak with Peter. Upon arrival at 8:18AM, I established that Peter wasn't home but the green Chevy Suburban was in the driveway. At this time, I called my supervisor S/Sgt. Herres #214, and informed him of the situation. The vehicle's license plate VCL320 matched the plate which was given to me by Manitowoc County. S/Sgt. Herres called Sgt. Pamerter #248 to take pictures of the Chevy Suburban.

The description of the 1979 Chevy Suburban is that it was previously white. It is now painted over to be green in color. The above vehicle has new tires, new bumpers, four round headlights, two of the headlights in front of the grill, rusty body, and a replacement grill. Upon looking at the engine, the fan shroud is in tack but could be new. The vehicle's VIN is [REDACTED].

Upon investigation it was found that the previous owner of the 1979 Chevy Suburban who Peter Stiltjes bought the listed vehicle from was Brian D. Opelt, m/w, DOB: [REDACTED], phone: [REDACTED], address of [REDACTED] Town Hall Road, Seymour, WI 54165. I tried to contact Mr. Opelt at home but was unsuccessful. However, S/Sgt. Herres contacted Mr. Opelt at work by telephone. Opelt stated the grill on the Suburban was replaced approximately 2 ½ years ago. S/Sgt. Herres confirmed this.

End of report.

Officer Clement #241/kp

12/02/99 Part 5
User: PARKERKL

INCIDENT DETAIL PRINT
OUTAGAMIE COUNTY SHERIFFS DEPARTMENT

99-0145-981 Page 3

ffns Rpt#: 1

VEHICLE INFORMATION

Document: 1 Filed By: 241 Date: 12/01/99 Status: Other

Type: Truck/Bus	Year: 79	Make:	Model:	
Wheel:	Body: Suburban	Top Color: GRN	Bottom Color:	G
License #	Registration No.	Year	Type	Vehicle ID. #
VCL320		00	A	
City	State	Ins. Co.		
	WI			
Recovery Cd:	Value:	.00	SID#:	CURRENT STATUS
				Other 12/01/1999

12/02/99 Part 8
User: PARKERKL

INCIDENT DETAIL PRINT
OUTAGAMIE COUNTY SHERIFFS DEPARTMENT

99-0145-981 Page 1

Doc #: 1 Type: S Filed by: 241 Date: 12/01/99 COMPLETE

Assist Manitowoc County Sheriff's Department with a Hit & Run fatal investigation from 01-10-99. Copy of report sent to Manitowoc County Sheriff on 12-02-99. #241 Clement/kp

1. CASE # S99 No 09845 2. CLASSIFICATION 6310.1 3. CENSUS 14002

4. INCIDENT CS / S99-00242

5. INCIDENT LOCATION Hwy CR & Silver Ck Rd

6. NAME-LAST-FIRST-MI Anonymous 7. D.O.B.

8. ADDRESS 9. TX-HOME

11. CITY STATE ZIP 10. TX-BUSINESS

12. DETAILS States Walter Nier

DOB [redacted] drives a

gray '89 Chev. pick-up

and was involved in a previous
OWI related accident.

11-30-99 1824
REC'D 14. 15. 16. 17.
DISP 10-23 10-24
13. DAY
SUN 1 THU 5
MON 2 FRI 6
TUE 3 SAT 7
WED 4

MANITOWOC COUNTY SHERIFF
INCIDENT CARD

18. ASSIGNED M50 929

19. REC. BY 925 20. DIS. BY

21. HOW REC'D.
1. 911
2. POLICE RADIO
3. PHONE
4. TTY
5. IN PERSON
6. ON VIEW
7. OFF. OFF DUTY
8. C.B. RADIO
9. OTHER

22. TYPE OF REPORT
1. INCIDENT
2. ACCIDENT
3. CITATION
4. NONE

23. STATUS
1. UNFOUNDED
2. PNL
3. OTHER
4. CLEARED
5. EXCEPT CLEARED

24. DATE CLEARED 12/16/99

25. OFFENSE TYPE
1. ADULT NA
2. JUVENILE
3. UNKNOWN

21A. M.O.

39. (CODE S-SUSPECT W-WITNESS V-VICTIM O-OTHER)
CODE: 40. NAME-LAST-FIRST MI 41. D.O.B. 42. ADDRESS 43. TELEPHONE

O NIER WALTER R. [redacted] OREGON ST, GREEN BAY [redacted]

12/16/99 @ 1840 Hrs.: I, Lt. M. Bushman, made contact with WALTER NIER. He stated he just walked in the door and had not even taken off his coat. He seemed somewhat bothered about me stopping at his residence to talk to him about this complaint but was very cooperative on the phone. I told him I was investigating a hit and run accident and I received an anonymous Crime Stopper report from Green Bay on a vehicle that he may have owned. I then went through the list of previously owned vehicles provided by DOT.

I started with the 1981 Chevrolet truck listed. NIER had to search his memory. He stated it was a pickup truck, beige and brown in color, and he bought it from someone out of Forestville. The engine blew, and he sold it to a party in Green Bay.

The next vehicle was a 1979 Ford LTD which he said he sold approximately 4 years ago.

The 1989 Chevrolet which was listed is an extended cab truck, silver over burgundy with a burgundy cap. NIER stated it looks like the current, today's model. I took this to mean it was the current, rounded-nose body style. This would not be the type of vehicle we are looking for.

I asked if anyone else in his house has a Chevrolet truck, Blazer, Suburban, or van that he may occasionally use. He stated he is 67 years old, lives with his wife alone, and their children are in their 40s and have moved on. He said he has never owned a Chevy van, Blazer, or Suburban.

NIER again asked my name, dept., and phone number, having his wife write it down as if he was somewhat skeptical of who was calling. He said he used to get to Manitowoc as he played for the Manitowoc Chiefs and still gets invitations to special events. He stated he does not come to Manitowoc very often, especially for their parties, because he knows he would be drinking and then has to drive 32 miles home and would not want to be arrested.

I then brought up the Crime Stopper Interview Form from the anonymous party in Green Bay

CASE # S99 No 098

45. IF COMPLAINANT DIFFERENT THEN CALLER, ENTER NAME, ADDRESS, D.O.B., TELEPHONE.

46. IF CODE O (OTHER) IS USED IN FIELD #39, EXPLAIN.

INCIDENT REPORT: NOTE: IF SECTION 22 ABOVE HAS NUMBER 4 CHECKED, DO NOT GO BEYOND THIS LINE WITHOUT RECORDS SECTION BEING ADVISED, OR NO RECORD ENTRIES WILL BE MADE BELOW THIS LINE.

PROPERTY VALUE	26. PROPERTY	A. CURRENCY	B. JEWELRY	C. FURS CLOTHING	D. VEHICLE (LOCAL)	E. OFFICE EQUIPMENT	F. RADIO, TV CAMERAS	G. FIREARMS	H. HOUSE-HOLD GOODS
	STOLEN	\$	\$	\$	\$	\$	\$	\$	\$
	RECOVERED	\$	\$	\$	\$	\$	\$	\$	\$
	26. PROPERTY	I. CONSUMABLES	J. LIVESTOCK	K. DRUGS	L. MARINE ITEMS	M. CONSTRUCTION ITEMS	N. LAWN AND GARDEN	O. SPORTING GOODS	P. MISC BICYCLE
	STOLEN	\$	\$	\$	\$	\$	\$	\$	\$
	RECOVERED	\$	\$	\$	\$	\$	\$	\$	\$

27. PROPERTY RECOVERED: LOCALLY _____ OTHER JURISDICTION _____ (INSERT O OR L)

PROPERTY ITEMIZATION	PROPERTY STOLEN/RECOVERED ITEMIZATION, USE THE FOLLOWING FORMAT				
	28. QUANTITY	29. ARTICLE NAME	30. BRAND NAME	31. SERIAL NUMBER	32. CODE
					S R <input type="checkbox"/> <input type="checkbox"/>
					S R <input type="checkbox"/> <input type="checkbox"/>
					S R <input type="checkbox"/> <input type="checkbox"/>
					S R <input type="checkbox"/> <input type="checkbox"/>

33. PROPERTY DAMAGE AMOUNT \$ _____ 34. INSURANCE COMPANY _____

35. OFFICER ASSAULTED Y N 36. ARSON Y N 37. STRUCTURE CODE _____ 38. DAMAGE \$ _____

47. CIB NCIC OTHER BROADCAST	ENTERED	CANCELLED	48. TOTAL AMOUNT PROPERTY STOLEN \$ _____
	<input type="checkbox"/>	<input type="checkbox"/>	
	<input type="checkbox"/>	<input type="checkbox"/>	
			49. TOTAL AMOUNT PROPERTY RECOVERED \$ _____

50. IS REPORT CONTINUED? YES NO 51. CAUTION INDICATORS, ATLS ETC.

52. DATA PROCESS INFORMATION:

COMPUTER ENTERED DATE 12/20/99
 MICROFILM INDEXED INITIAL KS

IS CASE CLASSIFICATION CORRECT? N
 IF N HAS CORRECTION BEEN MADE? N

53. FILE APPROVAL
 BY [Signature] DATE 12/20/99

MCSO 028 1/91

MANITOWOC COUNTY SHERIFF'S DEPARTMENT
FOLLOW-UP REPORT

Page: 2

CASE NUMBER: 599-09845 CLASSIFICATION: _____

INCIDENT: _____

DATE AND TIME: _____

REPORT CONTINUED:

specifically if he was involved in an accident on 01/02/99 in Green Bay, and he stated he was. He then changed the subject. I noted, on his DL record, he was convicted on 02/22/99 of OWS and on 08/02/99 for Failure to Stop for an Accident, both of these stemming from an incident on 01/02/99. I suspect he did not stop because he was suspended. When he got home, officers could not prove OWI as they made contact at a later time.

NIER also questioned the time of the accident and where it took place. He stated he works for the [REDACTED] approximately 12 hours a day and would keep his ears open if he has any further information. He advised me that I should feel free to call him at any time if there are any other questions.

I, Lt. Bushman, do not believe this is our suspect, although he was somewhat evasive with his answers; however, he does not have a vehicle that matches the description of the vehicle we are looking for. The Crime Stopper report stated NIER'S vehicle is possibly a match to the one we are looking for. NIER is a reported heavy drinker.

12/16/99 @ 1930 Hrs.: Contact was made with the anonymous complainant in this Crime Stopper. I advised him that I did some follow-up on it and just wanted to make sure the vehicle we were talking about is one in the same. I advised him the vehicle is a 1989 Chevrolet truck, silver and burgundy with a burgundy cap. I asked him if this was the vehicle he was calling in. The complainant stated this was definitely the vehicle he wished to report. I pointed out to him that particular vehicle did not fit the body style we were looking for and asked if there was any other vehicle that he might have been talking about. The complainant stated no, that was the vehicle, and he knows he was involved in an accident where he evaded police; therefore, he thought he would be a good suspect.

This is not the party we are looking for. MJBushman  /bjc

1. CASE # S99 No 09853 | 2. CLASSIFICATION 6310.11 | 3. CENSUS 7.010.00

4. INCIDENT CS/ 599-00242

5. INCIDENT LOCATION

6. NAME - LAST - FIRST - MI ANONYMOUS (2) | 7. D.O.B.

8. ADDRESS | 9. TX-HOME

11. CITY STATE ZIP | 10. TX-BUSINESS

12. DETAILS Female caller states that she knows an I/M

with the alias of Joe Fish who owns a red &

white Dodge Van with frontend damage. He stays

in Milwaukee but travels to the Menomonee

11-30-99 2215

14. REC'D	15. DISP	16. 10-23	17. 10-24
13. DAY			
SUN 1	THU 5		
MON 2	FRI 6		
TUE 3	SAT 7		
WED 4			

MANITOWOC COUNTY SHERIFF INCIDENT CARD		
18. ASSIGNED		4100 929
19. REC. BY 936		20. DIS. BY
21. HOW REC'D. 1. 911 2. POLICE RADIO 3. PHONE 4. TTY 5. IN PERSON 6. ON VIEW 7. OFF. OFF DUTY 8. C.B. RADIO 9. OTHER		22. TYPE OF REPORT 1. INCIDENT 2. ACCIDENT 3. CITATION 4. NONE
23. STATUS 1. UNFOUNDED 2. PNL 3. OTHER 4. CLEARED 5. EXCEPT CLEARED		24. DATE CLEARED 12/5/99
25. OFFENSE TYPE 1. ADULT <input type="checkbox"/> NA <input checked="" type="checkbox"/> 2. JUVENILE <input type="checkbox"/> 3. UNKNOWN <input type="checkbox"/>		
21A.M.O.		

39. (CODE S-SUSPECT W-WITNESS V-VICTIM O-OTHER)				42. ADDRESS		43. TELEPHONE	
CODE	40.NAME-LAST	FIRST	MI	41. D.O.B.			

Reservation and is also on the Wisconsin 10 Most Wanted List. He is also wanted in Wausau, Wisconsin on various warrants. She was given a CS number.936/RH

S99 No 09853

45. IF COMPLAINANT DIFFERENT THEN CALLER, ENTER NAME, ADDRESS, D.O.B., TELEPHONE.

46. IF CODE O (OTHER) IS USED IN FIELD #39, EXPLAIN.

INCIDENT REPORT: NOTE: IF SECTION 22 ABOVE HAS NUMBER 4 CHECKED, DO NOT GO BEYOND THIS LINE WITHOUT RECORDS SECTION BEING ADVISED, OR NO RECORD ENTRIES WILL BE MADE BELOW THIS LINE.

PROPERTY VALUE	26. PROPERTY	A. CURRENCY	B. JEWELRY	C. FURS CLOTHING	D. VEHICLE (LOCAL)	E. OFFICE EQUIPMENT	F. RADIO, TV CAMERAS	G. FIREARMS	H. HOUSE-HOLD GOODS
	STOLEN	\$	\$	\$	\$	\$	\$	\$	\$
	RECOVERED	\$	\$	\$	\$	\$	\$	\$	\$
	26. PROPERTY	I. CONSUMABLES	J. LIVESTOCK	K. DRUGS	L. MARINE ITEMS	M. CONSTRUCTION ITEMS	N. LAWN AND GARDEN	O. SPORTING GOODS	P. MISC BICYCLE
	STOLEN	\$	\$	\$	\$	\$	\$	\$	\$
	RECOVERED	\$	\$	\$	\$	\$	\$	\$	\$

27. PROPERTY RECOVERED: LOCALLY _____ OTHER JURISDICTION _____ (INSERT O OR L)

PROPERTY ITEMIZATION	PROPERTY STOLEN/RECOVERED ITEMIZATION, USE THE FOLLOWING FORMAT				
	28. QUANTITY	29. ARTICLE NAME	30. BRAND NAME	31. SERIAL NUMBER	32. CODE
					S R <input type="checkbox"/> <input type="checkbox"/>
					S R <input type="checkbox"/> <input type="checkbox"/>
					S R <input type="checkbox"/> <input type="checkbox"/>
					S R <input type="checkbox"/> <input type="checkbox"/>

33. PROPERTY DAMAGE AMOUNT \$ _____ 34. INSURANCE COMPANY _____

35. OFFICER ASSAULTED Y N 36. ARSON Y N 37. STRUCTURE CODE _____ 38. DAMAGE \$ _____

47. CIB	ENTERED <input type="checkbox"/>	CANCELLED <input type="checkbox"/>	48. TOTAL AMOUNT PROPERTY STOLEN \$ _____
NCIC	<input type="checkbox"/>	<input type="checkbox"/>	49. TOTAL AMOUNT PROPERTY RECOVERED \$ _____
OTHER BROADCAST	<input type="checkbox"/>	<input type="checkbox"/>	

50. IS REPORT CONTINUED? YES NO 51. CAUTION INDICATORS, ATLS ETC.

52. DATA PROCESS INFORMATION:

COMPUTER ENTERED DATE 12/3/99

MICROFILM INDEXED INITIAL KS

IS CASE CLASSIFICATION CORRECT? N

IF N HAS CORRECTION BEEN MADE? N

53. FILE APPROVAL

BY [Signature] DATE 12/10/99

INCIDENT CARD

4. INCIDENT C.S/599-000242

5. INCIDENT LOCATION [REDACTED] Oakfield St., Two Rivers

6. NAME-LAST-FIRST-MI [REDACTED] V. 14040

7. D.O.B. [REDACTED]

8. ADDRESS [REDACTED]

9. TX-HOME [REDACTED]

10. TX-BUSINESS [REDACTED]

11. CITY [REDACTED] STATE [REDACTED] ZIP [REDACTED]

12. DETAILS
Rpts observing a Chevy pickup with grill damage parked at Two Rivers Clinic. RP#620186.

02-09-00 1012

18. ASSIGNED MTSO 929
Colborn 432

19. REC. BY 901

20. DIS. BY -

21. HOW REC'D.
1. 911
2. POLICE RADIO
3. PHONE
4. TTY
5. IN PERSON
6. ON VIEW
7. OFF. OFF DUTY
8. C.B. RADIO
9. OTHER

22. TYPE OF REPORT
1. INCIDENT
2. ACCIDENT
3. CITATION
4. NONE

23. STATUS
1. UNFOUNDED
2. PNL
3. OTHER
4. CLEARED
5. EXCEPT CLEARED

24. DATE CLEARED 2/16/00

25. OFFENSE TYPE
1. ADULT NA
2. JUVENILE
3. UNKNOWN

14. REC'D	15. DISP	16. 10-23	17. 10-24
13. DAY			
SUN 1	THU 5		
MON 2	FRI 6		
TUE 3	SAT 7		
WED 4			

39. (CODE S-SUSPECT W-WITNESS V-VICTIM O-OTHER)	40. NAME-LAST	FIRST	MI	41. D.O.B.	42. ADDRESS	43. TELEPHONE
0	LAMBERT	JOHN	M	[REDACTED]	[REDACTED] Lambert Rd, Mishicot	[REDACTED]

02/11/00 @ 0400 Hrs.: I, Deputy E. Glaeser, was assigned this complaint by Lt. O'Hearn. I was informed to complete follow-up on this Crime Stopper report and attempt to make contact with the owner of the suspect vehicle. In observing the 10-28 information of WI truck RP 620186, it indicated this belongs on a 1989 Chevy truck listing to JOHN LAMBERT of Mishicot. I will attempt to make contact with the owner of the vehicle.

02/11/00 @ 0700 Hrs.: I attempted contact at [REDACTED] Lambert Rd, Mishicot, but met with negative results. A message was left on the answering machine for LAMBERT in regard to this vehicle, and I requested he contact me at MTSO.

02/12/00 @ 0725 Hrs.: I was contacted by LAMBERT in regard to this incident. LAMBERT was informed that a Crime Stopper report had been received on his vehicle having front end damage. He indicated this was the case. LAMBERT stated his vehicle was a 1989 Chevy 3/4 ton pickup truck. He stated he had been involved in a car-deer accident in late 1999 in Manitowoc Co. LAMBERT told me the report should be on file with MTSO. He further relayed his vehicle does not meet the suspect profile of our hit and run vehicle as he relayed the grill on his pickup is chrome in color and his vehicle has double headlights.

Due to the fact I was the south beat car on today's date, I indicated to LAMBERT that his information would be checked in our in-house computer and that I would still have to make a personal check of the vehicle and I would do so on 02/13/00 in the early morning hours.

02/12/00 @ 0800 Hrs.: I got a confirmation from Dispatch that LAMBERT had reported a car-deer accident on 11/09/99 in direct accordance to the information that he relayed to me. A check of LAMBERT'S vehicle will be made by me on 02/13/00.

Pending further follow-up. EJGlaeser /bjc

45. IF COMPLAINANT DIFFERENT THEN CALLER, ENTER NAME, ADDRESS, D.O.B., TELEPHONE.

46. IF CODE O (OTHER) IS USED IN FIELD #39, EXPLAIN.

INCIDENT REPORT: NOTE: IF SECTION 22 ABOVE HAS NUMBER 4 CHECKED, DO NOT GO BEYOND THIS LINE WITHOUT RECORDS SECTION BEING ADVISED, OR NO RECORD ENTRIES WILL BE MADE BELOW THIS LINE.

PROPERTY VALUE	26. PROPERTY	A. CURRENCY	B. JEWELRY	C. FURS CLOTHING	D. VEHICLE (LOCAL)	E. OFFICE EQUIPMENT	F. RADIO, TV CAMERAS	G. FIREARMS	H. HOUSE-HOLD GOODS
	STOLEN	\$	\$	\$	\$	\$	\$	\$	\$
	RECOVERED	\$	\$	\$	\$	\$	\$	\$	\$
	26. PROPERTY	I. CONSUMABLES	J. LIVESTOCK	K. DRUGS	L. MARINE ITEMS	M. CONSTRUCTION ITEMS	N. LAWN AND GARDEN	O. SPORTING GOODS	P. MISC BICYCLE
	STOLEN	\$	\$	\$	\$	\$	\$	\$	\$
	RECOVERED	\$	\$	\$	\$	\$	\$	\$	\$

27. PROPERTY RECOVERED: LOCALLY _____ OTHER JURISDICTION _____ (INSERT O OR L)

PROPERTY ITEMIZATION	PROPERTY STOLEN/RECOVERED ITEMIZATION, USE THE FOLLOWING FORMAT				
	28. QUANTITY	29. ARTICLE NAME	30. BRAND NAME	31. SERIAL NUMBER	32. CODE
					S R <input type="checkbox"/> <input type="checkbox"/>
					S R <input type="checkbox"/> <input type="checkbox"/>
					S R <input type="checkbox"/> <input type="checkbox"/>
					S R <input type="checkbox"/> <input type="checkbox"/>
					S R <input type="checkbox"/> <input type="checkbox"/>

33. PROPERTY DAMAGE AMOUNT \$ _____

34. INSURANCE COMPANY _____

35. OFFICER ASSAULTED Y N

36. ARSON Y N

37. STRUCTURE CODE _____

38. DAMAGE \$ _____

47. CIB ENTERED CANCELLED
 NCIC
 OTHER BROADCAST

48. TOTAL AMOUNT PROPERTY STOLEN \$ _____

49. TOTAL AMOUNT PROPERTY RECOVERED \$ _____

50. IS REPORT CONTINUED? YES NO

51. CAUTION INDICATORS, ATLS ETC.

52. DATA PROCESS INFORMATION:

COMPUTER ENTERED DATE 12/16/00
 MICROFILM INDEXED INITIAL KS

IS CASE CLASSIFICATION CORRECT? N
 IF N HAS CORRECTION BEEN MADE? N

53. FILE APPROVAL

BY [Signature] DATE 12/16/00

16,510,11, 16,010,00

4. INCIDENT
CS / S99-00242

5. INCIDENT LOCATION
OTH CR

6. NAME - LAST - FIRST - MI
TRPD

7. D.O.B.
106

8. ADDRESS

9. TX-HOME

11. CITY STATE ZIP

10. TX-BUSINESS

12. DETAILS
OFFICER REQ. INCIDENT

02-15-00

14. REC'D
15. DISP
16. 10-23
17. 10-24

13. DAY
SUN 1 THU 5
MON 2 FRI 6
TUE 3 SAT 7
WED 4

INCIDENT CARD

18. ASSIGNED
COLBORN
MITSO
Lt. Bushman

4312
929
441

19. REC. BY
939

20. DIS. BY

22. TYPE OF REPORT
1. INCIDENT
2. ACCIDENT
3. CITATION
4. NONE

21. HOW REC'D.
1. 911
2. POLICE RADIO
3. PHONE
4. TTY
5. IN PERSON
6. ON VIEW
7. OFF. OFF DUTY
8. C.B. RADIO
9. OTHER

23. STATUS
1. UNFOUNDED
2. PNL
3. OTHER
4. CLEARED
5. EXCEPT CLEARED

24. DATE CLEARED
10/17/00

25. OFFENSE TYPE
1. ADULT NA
2. JUVENILE
3. UNKNOWN

39. (CODE S-SUSPECT W-WITNESS V-VICTIM O-OTHER)						
CODE	40. NAME-LAST	FIRST	MI	41. D.O.B.	42. ADDRESS	43. TELEPHONE
O	Peroutka, Scott R.	S	R	5/18/	Tannery Rd, Mishicot	

02/15/00 @ 2245 Hrs.: I, Lt. M. Bushman, made contact with SCOTT PEROUTKA at [redacted] Tannery Rd, Mishicot. I read some of the information from the Crime Stopper complaint which was anonymous accusing PEROUTKA of possibly being involved with the RICK HOCHSTETLER incident. I questioned whether he had a mini-van may have been involved in an accident approximately a year ago. He immediately stated yes, he did. He stated the incident happened near ECK FOUNDRY, just north of the City of Manitowoc. Ruzek's Wrecker pulled him from the ditch, and MTPD should be aware of the incident as they were on the scene.

He then took me out to look at his 1988 Ford mini-van, brown in color, with WI RP TGW430. It was immediately noted that the Ford mini-van had nothing in common with the suspect vehicle we are looking for. MJBushman /bjc

45. IF COMPLAINANT DIFFERENT THEN CALLER, ENTER NAME, ADDRESS, D.O.B., TELEPHONE.

46. IF CODE O (OTHER) IS USED IN FIELD #39, EXPLAIN.

INCIDENT REPORT: NOTE: IF SECTION 22 ABOVE HAS NUMBER 4 CHECKED, DO NOT GO BEYOND THIS LINE WITHOUT RECORDS SECTION BEING ADVISED, OR NO RECORD ENTRIES WILL BE MADE BELOW THIS LINE.

PROPERTY VALUE	26. PROPERTY	A. CURRENCY	B. JEWELRY	C. FURS CLOTHING	D. VEHICLE (LOCAL)	E. OFFICE EQUIPMENT	F. RADIO, TV CAMERAS	G. FIREARMS	H. HOUSE-HOLD GOODS
	STOLEN	\$	\$	\$	\$	\$	\$	\$	\$
	RECOVERED	\$	\$	\$	\$	\$	\$	\$	\$
	26. PROPERTY	I. CONSUMABLES	J. LIVESTOCK	K. DRUGS	L. MARINE ITEMS	M. CONSTRUCTION ITEMS	N. LAWN AND GARDEN	O. SPORTING GOODS	P. MISC BICYCLE
STOLEN	\$	\$	\$	\$	\$	\$	\$	\$	
RECOVERED	\$	\$	\$	\$	\$	\$	\$	\$	

27. PROPERTY RECOVERED: LOCALLY _____ OTHER JURISDICTION _____ (INSERT O OR L)

PROPERTY ITEMIZATION	PROPERTY STOLEN/RECOVERED ITEMIZATION, USE THE FOLLOWING FORMAT				
	28. QUANTITY	29. ARTICLE NAME	30. BRAND NAME	31. SERIAL NUMBER	32. CODE
					S R <input type="checkbox"/> <input type="checkbox"/>
					S R <input type="checkbox"/> <input type="checkbox"/>
					S R <input type="checkbox"/> <input type="checkbox"/>
					S R <input type="checkbox"/> <input type="checkbox"/>
					S R <input type="checkbox"/> <input type="checkbox"/>

33. PROPERTY DAMAGE AMOUNT \$ _____ 34. INSURANCE COMPANY _____

35. OFFICER ASSAULTED Y N 36. ARSON Y N 37. STRUCTURE CODE _____ 38. DAMAGE \$ _____

47. CIB	ENTERED	CANCELLED	48. TOTAL AMOUNT PROPERTY STOLEN \$ _____
	<input type="checkbox"/>	<input type="checkbox"/>	
	NCIC	<input type="checkbox"/>	
OTHER BROADCAST	<input type="checkbox"/>	<input type="checkbox"/>	49. TOTAL AMOUNT PROPERTY RECOVERED \$ _____

50. IS REPORT CONTINUED? YES NO

51. CAUTION INDICATORS, ATLS ETC.

52. DATA PROCESS INFORMATION:

COMPUTER ENTERED DATE 13.3.00
 MICROFILM INDEXED INITIAL AS

53. FILE APPROVAL

IS CASE CLASSIFICATION CORRECT? Y N
 IF N HAS CORRECTION BEEN MADE? Y N

BY [Signature] DATE 02-17-00

INCIDENT # 83430

SUPV. INT. CLASSIFICATION BEAT

TWO RIVERS POLICE INCIDENT CARD

INCIDENT TYPE ANONYMOUS INFO - 599-00242

INCIDENT LOCATION

NAME (last, first, middle) ANONYMOUS

D.O.B.

ADDRESS

HOME TELEPHONE

CITY

STATE

ZIP

WORK TELEPHONE

NARRATIVE

RECEIVE INFO REGARDS THE H + R FROM MTSO 599-00242

REC'D 02/04/00 2112

DISP

10-23

10-24

DAY SUN MON TUE WED THU FRI SAT

OFFICERS ASSIGNED:

LT. MIXA 822

REC. BY 946

DIS. BY 9

TYPE/REPORT

- 1 ACCIDENT OFFICER NARRATIVE
2 CASE
3 ARREST
4 CITATION
5 INCIDENT

- HOW RECEIVED ALM ALARM, SCN AT THE SCENE, CB CB RADIO, DIS DISPATCH, FAX FAX, FOP FOUND/PATROL, DSK FRONT DESK, PER IN PERSON, MAL MAIL, OFF OFFICER/OFF DUTY, OTH OTHER, OTH OTHER AGENCY, RAD RADIO

- STATUS AC ACTIVE, CA CLEARED/ARREST, CL CLOSED, CO COMMITMENT, EMER DETEN

- TDD TELEPHONE/DEAF, TEL TELEPHONE, TTY TELETYPE, 911 911 TELEPHONE

- DA DETENTION/ALCOHOL, EC EX CLEAR, IN INACTIVE, OT OTHER

IF COMPLAINANT DIFFERENT THEN CALLER, ENTER NAME, ADDRESS, D.O.B., TELEPHONE

T.I.M.E. SYSTEM ENTRY

Table with columns: ENTERED, DATE, TIME, INITIALS, CANCELLED, DATE, TIME, INITIALS. Rows for CIB, NCIC, OTHER BROADCAST.

ALL SHADED AREAS TO BE COMPLETED BY TWO RIVERS POLICE DEPARTMENT EMPLOYEES

TWO RIVERS POLICE DEPARTMENT EMPLOYEES TO COMPLETE INFORMATION BELOW

INVESTIGATIVE PROCESSING INFORMATION:

- EVIDENCE COLLECTED, PROPERTY COLLECTED, PHOTOGRAPHS TAKEN, VIDEOS TAKEN, STATEMENTS COMPLETED, NON-CONSENT FORM COMPLETED, FINGERPRINTS LIFTED, SUSPECT FINGERPRINTS TAKEN

ASSIGNMENTS:

Table with columns: OFFICER, TASK, DATE ASSIGNED, DATE DUE. Rows #1, #2, #3, #4.

INCIDENT # 83430

CASE DISPOSITION:

- ARREST, COMPLETED, INACTIVE, ACTIVE, UNFOUNDED

DATE COMPLETED:

2-07-00

City Of Two Rivers Police
DATE 02/07/2000
TIME 8:51:52

AEGIS PUBLIC SAFETY SYSTEM
INCIDENT REPORT

PAGE 1
PL1190
~~KIMPRI~~

INCIDENT #: 2000-00083430 ORI #: TRPD INCIDENT TYPE: 4708 P Dept Info

LOCATION . . . : █████ EAST PARK ST VENUE: Two Rivers
NATURE OF CALL: ANONYMOUS INFO

 DATE: TIME:
CALL : 02/04/2000 21:12:00
DISPATCH . . . : 02/04/2000 21:12:00
ARRIVE 1 . . . : 02/04/2000 21:12:00
CLEAR : 02/04/2000 21:12:00

AREA . : BEAT 1 SECTION : 1041 BEAT: Beat 1
QUADRANT: DISTRICT: GRID:

UNIT 1 #: ID # 1: MIXA, MICHAEL, J, ID # 2:
UNIT 2 #: ID # 3: ID # 4:

RECEIVED ORI/ID : TRPD
DISPATCH ORI/ID : TRPD
DISPATCH SHIFT :
SOURCE : REPORT REQUIRED: NO MUTUAL AID:
DISPOSITION . . : No Rpt Rqd PRIORITY . . . : 1 CREATED BY: KIMPRI
LICENSE PLATE . . : LICENSE STATE :

ORIGINAL INFORMATION:
LOCATION : █████, EAST PARK, ST, VENUE: Two Rivers
INCD TYPE: 4708 P Dept Info PRIORITY: 1

STATUS/DISPOSITIONS:
DISPOSITION: UNIT: DATE: TIME: ID # 1: / ID # 2:
No Rpt Rqd 02/04/2000 21:12:00 MIXA, MICHAEL, J,

DOCUMENTS:
narrative
Received information regarding the hit and run from MTSO S99-00242.
see officers report.

SOU INE 02021 1630.11 11.40.02

INCIDENT CARD

4. INCIDENT *CS/599-00242*

5. INCIDENT/LOCATION

6. NAME LAST-FIRST-MI [REDACTED] 7. D.O.B.

8. ADDRESS [REDACTED] 9. TX-HOME [REDACTED]

11. CITY STATE ZIP 10. TX-BUSINESS

030900 1225

18. ASSIGNED *MTSO 9A9*

19. REC. BY *920* 20. DIS. BY

21. HOW REC'D.
 1. 911
 2. POLICE RADIO
 3. PHONE
 4. TTY
 5. IN PERSON
 6. ON VIEW
 7. OFF. OFF DUTY
 8. C.B. RADIO
 9. OTHER

22. TYPE OF REPORT
 1. INCIDENT
 2. ACCIDENT
 3. CITATION
 4. NONE

23. STATUS
 1. UNFOUNDED
 2. PNL
 3. OTHER
 4. CLEARED
 5. EXCEPT CLEARED

24. DATE CLEARED *15 17 00*

25. OFFENSE TYPE
 1. ADULT NA
 2. JUVENILE
 3. UNKNOWN

12. DETAILS
Caller observed black Chev. pickup parked on 20th between Superior & Sieman. Appears male subj. is doing home body work.

14. REC'D 15. DISP 16. 10-23 17. 10-24

13. DAY
 SUN 1 THU 5
 MON 2 FRI 6
 TUE 3 SAT 7
 WED 4

Confidential

39. (CODE S-SUSPECT W-WITNESS V-VICTIM O-OTHER)

CODE	40. NAME-LAST	FIRST	MI	41. D.O.B.	42. ADDRESS	43. TELEPHONE

SOU INE 02021

45. IF COMPLAINANT DIFFERENT THEN CALLER, ENTER NAME, ADDRESS, D.O.B., TELEPHONE.

46. IF CODE O (OTHER) IS USED IN FIELD #39, EXPLAIN.

INCIDENT REPORT: NOTE: IF SECTION 22 ABOVE HAS NUMBER 4 CHECKED, DO NOT GO BEYOND THIS LINE WITHOUT RECORDS SECTION BEING ADVISED, OR NO RECORD ENTRIES WILL BE MADE BELOW THIS LINE.

PROPERTY VALUE	26. PROPERTY	A. CURRENCY	B. JEWELRY	C. FURS CLOTHING	D. VEHICLE (LOCAL)	E. OFFICE EQUIPMENT	F. RADIO, TV CAMERAS	G. FIREARMS	H. HOUSE-HOLD GOODS
	STOLEN	\$	\$	\$	\$	\$	\$	\$	\$
	RECOVERED	\$	\$	\$	\$	\$	\$	\$	\$
	26. PROPERTY	I. CONSUMABLES	J. LIVESTOCK	K. DRUGS	L. MARINE ITEMS	M. CONSTRUCTION ITEMS	N. LAWN AND GARDEN	O. SPORTING GOODS	P. MISC BICYCLE
	STOLEN	\$	\$	\$	\$	\$	\$	\$	\$
	RECOVERED	\$	\$	\$	\$	\$	\$	\$	\$

27. PROPERTY RECOVERED: LOCALLY _____ OTHER JURISDICTION _____ (INSERT O OR L)

PROPERTY ITEMIZATION	PROPERTY STOLEN/RECOVERED ITEMIZATION, USE THE FOLLOWING FORMAT				
	28. QUANTITY	29. ARTICLE NAME	30. BRAND NAME	31. SERIAL NUMBER	32. CODE
					S R <input type="checkbox"/> <input type="checkbox"/>
					S R <input type="checkbox"/> <input type="checkbox"/>
					S R <input type="checkbox"/> <input type="checkbox"/>
					S R <input type="checkbox"/> <input type="checkbox"/>

33. PROPERTY DAMAGE AMOUNT \$ _____

34. INSURANCE COMPANY _____

35. OFFICER ASSAULTED Y N

36. ARSON Y N

37. STRUCTURE CODE _____

38. DAMAGE \$ _____

47. CIB
NCIC
OTHER BROADCAST

ENTERED
CANCELLED

48. TOTAL AMOUNT PROPERTY STOLEN \$ _____

49. TOTAL AMOUNT PROPERTY RECOVERED \$ _____

50. IS REPORT CONTINUED? YES NO

51. CAUTION INDICATORS, ATLS ETC.

52. DATA PROCESS INFORMATION:

COMPUTER ENTERED DATE 05/17/00
MICROFILM INDEXED INITIAL KS

53. FILE APPROVAL

IS CASE CLASSIFICATION CORRECT?
IF N HAS CORRECTION BEEN MADE?

Y N
 Y N

BY KP

DATE 05/16/00

SOU 11-0000 0311 170100Z

4. INCIDENT CS 599-00242

5. INCIDENT LOCATION

6. NAME- LAST-FIRST-MI Anonyms 7. D.O.B.

8. ADDRESS 9. TX-HOME

11. CITY STATE ZIP 10. TX-BUSINESS

12. DETAILS
 rec'd info re: suspect
 veh, htr, acc
 attached

031030092

INCIDENT CARD

18. ASSIGNED Glaeser 4117
 MTSO 929

19. REC. BY 921 20. DIS. BY

21. HOW REC'D.
 1. 911
 2. POLICE RADIO
 3. PHONE
 4. CITY
 5. IN PERSON
 6. ON VIEW
 7. OFF. OFF DUTY
 8. C.B. RADIO
 9. OTHER

22. TYPE OF REPORT
 1. INCIDENT
 2. ACCIDENT
 3. CITATION
 4. NONE

23. STATUS
 1. UNFOUNDED
 2. PNL
 3. OTHER
 4. CLEARED
 5. EXCEPT CLEARED

24. DATE CLEARED 03/19/00

25. OFFENSE TYPE
 1. ADULT NA
 2. JUVENILE
 3. UNKNOWN

14. REC'D 15. DISP 16. 10-23 17. 10-24

13. DAY
 SUN 1 THU 5
 MON 2 FRI 6
 TUE 3 SAT 7
 WED 4

39. (CODE S-SUSPECT W-WITNESS V-VICTIM O-OTHER)	40. NAME-LAST	FIRST	MI	41. D.O.B.	42. ADDRESS	43. TELEPHONE
0	[REDACTED]	84913	[REDACTED]	[REDACTED]	[REDACTED]	[REDACTED]
0	[REDACTED]	94914	[REDACTED]	[REDACTED]	[REDACTED]	[REDACTED]

03-11-00 @ 0840 hrs.: I, Deputy E Glaeser, spoke to [REDACTED] in regards to our hit & run investigation. [REDACTED] told me he is a student at the UW Milwaukee and he recently noticed one of our hit & run investigation signs posted at a car auction in the City of Fond du Lac. [REDACTED] told me that he has noticed a veh. that matches our suspect description parked on the upper story of a parking lot at Union Garage at UW Milwaukee campus. [REDACTED] described the veh. as a brown & tan Chevy 20 van and he also stated it displays WI RP# LPR845. [REDACTED] told me that he has noticed the veh. parked there several times in the early afternoon hours and when he noticed the right front damage to the grill area of the van and the damage to the right side of the van, he decided to call MTSO to report this veh.

When I asked [REDACTED] to describe the area of damage, he told me it would be to the upper right grill area and he stated it was approx. 6" by 8" wide. [REDACTED] also stated that the grill composition would be a flat silver in color and he described the head lamps as being square with a single head lamp on either side of the grill.

[REDACTED] also told me that he had never seen the operator of the van but he has seen it at the UW parking lot at least on 3 separate occasions.

I ran a 10-28 on RP# LPR845. It does indicate the registered owner to be a CHARLES CHERNEY of West Allis. The RP# would be for a 1985 Chevy Truck. Dispatch was able to locate a telephone # for MR. CHERNEY and attempt will be made to contact him regarding the damage to the veh.

03-11-00 @ 0924 hrs.: I, Deputy Glaeser, spoke to CHARLES CHERNEY in regards to this incident. CHERNEY told me that the veh. in question is actually registered to his father, CHARLES SR., but he did relay to me that the damage to the right front grill area was sustained to the van last year while CHARLES JR. was operating the veh. CHARLES told me that he struck a deer on his way home from a car show in Iola and he described the damage to the grill and the right side of the veh. consistent with what [REDACTED] reported to me. CHARLES CHERNEY did state to me; however, that the amount of damage to the grill area was very minimal and he stated in fact he still had the grill pieces, they never fell out of

45. IF COMPLAINANT DIFFERENT THEN CALLER, ENTER NAME, ADDRESS, D.O.B., TELEPHONE.

46. IF CODE O (OTHER) IS USED IN FIELD #39, EXPLAIN.

INCIDENT REPORT: NOTE: IF SECTION 22 ABOVE HAS NUMBER 4 CHECKED, DO NOT GO BEYOND THIS LINE WITHOUT RECORDS SECTION BEING ADVISED, OR NO RECORD ENTRIES WILL BE MADE BELOW THIS LINE.

PROPERTY VALUE	26. PROPERTY	A. CURRENCY	B. JEWELRY	C. FURS CLOTHING	D. VEHICLE (LOCAL)	E. OFFICE EQUIPMENT	F. RADIO, TV CAMERAS	G. FIREARMS	H. HOUSE-HOLD GOODS
	STOLEN	\$	\$	\$	\$	\$	\$	\$	\$
	RECOVERED	\$	\$	\$	\$	\$	\$	\$	\$
	26. PROPERTY	I. CONSUMABLES	J. LIVESTOCK	K. DRUGS	L. MARINE ITEMS	M. CONSTRUCTION ITEMS	N. LAWN AND GARDEN	O. SPORTING GOODS	P. MISC BICYCLE
	STOLEN	\$	\$	\$	\$	\$	\$	\$	\$
	RECOVERED	\$	\$	\$	\$	\$	\$	\$	\$

27. PROPERTY RECOVERED: LOCALLY _____ OTHER JURISDICTION _____ (INSERT O OR L)

PROPERTY ITEMIZATION	PROPERTY STOLEN/RECOVERED ITEMIZATION, USE THE FOLLOWING FORMAT				
	28. QUANTITY	29. ARTICLE NAME	30. BRAND NAME	31. SERIAL NUMBER	32. CODE
					S R <input type="checkbox"/> <input type="checkbox"/>
					S R <input type="checkbox"/> <input type="checkbox"/>
					S R <input type="checkbox"/> <input type="checkbox"/>
					S R <input type="checkbox"/> <input type="checkbox"/>
					S R <input type="checkbox"/> <input type="checkbox"/>

33. PROPERTY DAMAGE AMOUNT \$ _____ 34. INSURANCE COMPANY _____

35. OFFICER ASSAULTED Y N 36. ARSON Y N 37. STRUCTURE CODE _____ 38. DAMAGE \$ _____

47. CIB	ENTERED <input type="checkbox"/>	CANCELLED <input type="checkbox"/>	48. TOTAL AMOUNT PROPERTY STOLEN \$ _____
NCIC	<input type="checkbox"/>	<input type="checkbox"/>	
OTHER BROADCAST	<input type="checkbox"/>	<input type="checkbox"/>	
			49. TOTAL AMOUNT PROPERTY RECOVERED \$ _____

50. IS REPORT CONTINUED? YES NO 51. CAUTION INDICATORS, ATLS ETC.

52. DATA PROCESS INFORMATION:

COMPUTER ENTERED DATE 13/20/09

MICROFILM INDEXED INITIAL KS

IS CASE CLASSIFICATION CORRECT? N

IF N HAS CORRECTION BEEN MADE? Y

53. FILE APPROVAL

BY [Signature] DATE 12/14/09

MANITOWOC COUNTY SHERIFF'S DEPARTMENT
FOLLOW-UP REPORT

Page: 2

CASE NUMBER: 500-02039 CLASSIFICATION: _____

INCIDENT: _____

DATE AND TIME: _____

REPORT CONTINUED:

the grill. CHERNEY said that most of the damage to the van is from when the deer struck the passenger's side door and directional turn signal area. I asked CHERNEY if the accident had been reported to any law enforcement agency and he told me that it was not, but that it was checked over by an insurance adjuster and his father was paid out a claim for the damage on the veh. CHERNEY did state that there were still hairs imbedded from the deer in the upper hood area and on the side door of the van.

When I asked CHERNEY to describe the area of damage on the grill, he stated to me that it was an area of about 2-4 square inches of grill that was broken, but he again reiterated that he still had those grill pieces.

Due to the fact that this particular damage area is inconsistent with our suspect veh., the CHERNEY veh. can be eliminated from suspicion and it should further be noted that the information on the veh. and on CHARLES CHERNEY was entered onto the FBI investigation program. No further action taken. EGlaser/ *ETG* klf

300 11- 02710 12, 1171, 1001072

4. INCIDENT
Crime Stopper/899-00242

5. INCIDENT LOCATION

6. NAME - LAST - FIRST - MI
Anon

7. D.O.B.

8. ADDRESS

9. TX-HOME

11. CITY STATE ZIP

10. TX-BUSINESS

12. DETAILS
See Attached

03-22-00 1652

14. REC'D

15. DISP

16. 10-23

17. 10-24

13. DAY

SUN 1 THU 5

MON 2 FRI 6

TUE 3 SAT 7

WED 4

INCIDENT CARD

18. ASSIGNED
MT50 *400*
929

19. REC. BY
951

20. DIS. BY

22. TYPE OF REPORT

1. INCIDENT

2. ACCIDENT

3. CITATION

4. NONE

21. HOW REC'D.

1. 911

2. POLICE RADIO

3. PHONE

4. TTY

5. IN PERSON

6. ON VIEW

7. OFF. OFF DUTY

8. C.B. RADIO

9. OTHER

23. STATUS

1. UNFOUNDED

2. PNL

3. OTHER

4. CLEARED

5. EXCEPT CLEARED

24. DATE CLEARED
15/7/00

21A. M.O.

25. OFFENSE TYPE

1. ADULT NA

2. JUVENILE

3. UNKNOWN

39. (CODE S-SUSPECT W-WITNESS V-VICTIM O-OTHER)					42. ADDRESS		43. TELEPHONE
CODE	40. NAME-LAST	FIRST	MI	41. D.O.B.			

45. IF COMPLAINANT DIFFERENT THEN CALLER, ENTER NAME, ADDRESS, D.O.B., TELEPHONE.

46. IF CODE O (OTHER) IS USED IN FIELD #39, EXPLAIN.

INCIDENT REPORT: NOTE: IF SECTION 22 ABOVE HAS NUMBER 4 CHECKED, DO NOT GO BEYOND THIS LINE WITHOUT RECORDS SECTION BEING ADVISED, OR NO RECORD ENTRIES WILL BE MADE BELOW THIS LINE.

PROPERTY VALUE	26. PROPERTY	A. CURRENCY	B. JEWELRY	C. FURS CLOTHING	D. VEHICLE (LOCAL)	E. OFFICE EQUIPMENT	F. RADIO, TV CAMERAS	G. FIREARMS	H. HOUSE-HOLD GOODS
	STOLEN	\$	\$	\$	\$	\$	\$	\$	\$
	RECOVERED	\$	\$	\$	\$	\$	\$	\$	\$
	26. PROPERTY	I. CONSUM-ABLES	J. LIVESTOCK	K. DRUGS	L. MARINE ITEMS	M. CONSTRUCTION ITEMS	N. LAWN AND GARDEN	O. SPORTING GOODS	P. MISC BICYCLE
	STOLEN	\$	\$	\$	\$	\$	\$	\$	\$
	RECOVERED	\$	\$	\$	\$	\$	\$	\$	\$

27. PROPERTY RECOVERED: LOCALLY _____ OTHER JURISDICTION _____ (INSERT O OR L)

PROPERTY ITEMIZATION	PROPERTY STOLEN/RECOVERED ITEMIZATION, USE THE FOLLOWING FORMAT				
	28. QUANTITY	29. ARTICLE NAME	30. BRAND NAME	31. SERIAL NUMBER	32. CODE
					S R <input type="checkbox"/> <input type="checkbox"/>
					S R <input type="checkbox"/> <input type="checkbox"/>
					S R <input type="checkbox"/> <input type="checkbox"/>
					S R <input type="checkbox"/> <input type="checkbox"/>
					S R <input type="checkbox"/> <input type="checkbox"/>

33. PROPERTY DAMAGE AMOUNT \$ _____

34. INSURANCE COMPANY _____

35. OFFICER ASSAULTED Y N

36. ARSON Y N

37. STRUCTURE CODE _____ 38. DAMAGE \$ _____

47. CIB ENTERED CANCELLED
 NCIC
 OTHER BROADCAST

48. TOTAL AMOUNT PROPERTY STOLEN \$ _____

49. TOTAL AMOUNT PROPERTY RECOVERED \$ _____

50. IS REPORT CONTINUED? YES NO

51. CAUTION INDICATORS, ATLS ETC.

52. DATA PROCESS INFORMATION:

COMPUTER ENTERED DATE 15/17/00
 MICROFILM INDEXED INITIAL KS

53. FILE APPROVAL

IS CASE CLASSIFICATION CORRECT? N
 IF N HAS CORRECTION BEEN MADE? N

BY [Signature] DATE 05/16/00

SOU 14- 00020 16,210,11 12,200,0

INCIDENT CARD

4. INCIDENT *CS / 500-00 242*

5. INCIDENT LOCATION

6. NAME - LAST - FIRST - MI *Anonymous* 7. D.O.B.

8. ADDRESS 9. TX-HOME

11. CITY STATE ZIP 10. TX-BUSINESS

12. DETAILS *See attached.*

04/28/60 1570

18. ASSIGNED *Crimstoppers* *929*

19. REC. BY *935* 20. DIS. BY

22. TYPE OF REPORT
 1. INCIDENT
 2. ACCIDENT
 3. CITATION
 4. NONE

21. HOW REC'D.
 1. 911
 2. POLICE RADIO
 3. PHONE
 4. TTY
 5. IN PERSON
 6. ON VIEW
 7. OFF. OFF DUTY
 8. C.B. RADIO
 9. OTHER

23. STATUS
 1. UNFOUNDED
 2. PNL
 3. OTHER
 4. CLEARED
 5. EXCEPT CLEARED

24. DATE CLEARED *15 17 00*

25. OFFENSE TYPE
 1. ADULT NA
 2. JUVENILE
 3. UNKNOWN

14. REC'D. 15. DISP. 16. 10-23 17. 10-24

13. DAY
 SUN 1 THU 5
 MON 2 FRI 6
 TUE 3 SAT 7
 WED 4

39. (CODE S-SUSPECT W-WITNESS V-VICTIM O-OTHER)						
CODE	40. NAME-LAST	FIRST	MI	41. D.O.B.	42. ADDRESS	43. TELEPHONE

45. IF COMPLAINANT DIFFERENT THEN CALLER, ENTER NAME, ADDRESS, D.O.B., TELEPHONE.

46. IF CODE O (OTHER) IS USED IN FIELD #39, EXPLAIN.

INCIDENT REPORT: NOTE: IF SECTION 22 ABOVE HAS NUMBER 4 CHECKED, DO NOT GO BEYOND THIS LINE WITHOUT RECORDS SECTION BEING ADVISED, OR NO RECORD ENTRIES WILL BE MADE BELOW THIS LINE.

PROPERTY VALUE	26. PROPERTY	A. CURRENCY	B. JEWELRY	C. FURS CLOTHING	D. VEHICLE (LOCAL)	E. OFFICE EQUIPMENT	F. RADIO, TV CAMERAS	G. FIREARMS	H. HOUSE-HOLD GOODS
	STOLEN	\$	\$	\$	\$	\$	\$	\$	\$
	RECOVERED	\$	\$	\$	\$	\$	\$	\$	\$
	26. PROPERTY	I. CONSUMABLES	J. LIVESTOCK	K. DRUGS	L. MARINE ITEMS	M. CONSTRUCTION ITEMS	N. LAWN AND GARDEN	O. SPORTING GOODS	P. MISC BICYCLE
	STOLEN	\$	\$	\$	\$	\$	\$	\$	\$
	RECOVERED	\$	\$	\$	\$	\$	\$	\$	\$

27. PROPERTY RECOVERED: LOCALLY ____ OTHER JURISDICTION ____ (INSERT O OR L)

PROPERTY ITEMIZATION	PROPERTY STOLEN/RECOVERED ITEMIZATION, USE THE FOLLOWING FORMAT				
	28. QUANTITY	29. ARTICLE NAME	30. BRAND NAME	31. SERIAL NUMBER	32. CODE
					S R <input type="checkbox"/> <input type="checkbox"/>
					S R <input type="checkbox"/> <input type="checkbox"/>
					S R <input type="checkbox"/> <input type="checkbox"/>
					S R <input type="checkbox"/> <input type="checkbox"/>

33. PROPERTY DAMAGE AMOUNT \$ _____ 34. INSURANCE COMPANY _____

35. OFFICER ASSAULTED Y N 36. ARSON Y N 37. STRUCTURE CODE _____ 38. DAMAGE \$ _____

47. CIB ENTERED CANCELLED
 NCIC
 OTHER BROADCAST

48. TOTAL AMOUNT PROPERTY STOLEN \$ _____

49. TOTAL AMOUNT PROPERTY RECOVERED \$ _____

50. IS REPORT CONTINUED? YES NO

51. CAUTION INDICATORS, ATLS ETC.

52. DATA PROCESS INFORMATION:

COMPUTER ENTERED DATE 15/17/00
 MICROFILM INDEXED INITIAL AS

53. FILE APPROVAL

IS CASE CLASSIFICATION CORRECT? N
 IF N HAS CORRECTION BEEN MADE? N

BY RS DATE 05/16/00

1570
MV
3170E
Chevy Color - 2 tone Gold (Brown)
Full size 8085
1 mile behind
8085
8085

SB
Saw in
Rear view
Mirror

1997 WISCONSIN DEALER BOOK

03151	A-D	ALFA HEAVEN INC SSZ JOSEPH T ZATLOUKAL DALE M ZATLOUKAL		█████ NOLAN ROAD	ANIWA	WI	54408	█████	11/30/98
03152	A-D	DIGMAN TRUCK AND AUTO MICHAEL J DIGMAN		█████ E HWY 151	PLATTEVILLE	WI	53818	█████	11/30/98
03164	A-C	MOTORSPORTS OF RICE LAKE INC USED		█████ S MAIN	RICE LAKE	WI	54868	█████	11/30/98
03155	A-J	THREE CORNERS MOTORS INC USED MICHAEL N SIVAS		█████ CEDAR STREET	GREEN BAY	WI	54302	█████	01/31/99
03158	A-P	CHAMPION MOTORS USED DONALD E LAVRENZ		█████ SOUTH MILITARY ROAD	FOND DU LAC	WI	54935	█████	11/30/98
03159	A-D	PARCO AUTO SALES USED JOHN A PARELLO	STATELINE BODY & CHASSIS	█████ ANTIOCH RD	TREVOR	WI	53179	█████	11/30/98
03160	A-E	WAUNAKEE MOTORS USED MORRIS L MAXWELL		█████ EAST MAIN	WAUNAKEE	WI	53597	█████	01/31/99
03161	A-D	WALWORTH AUTO BROKERS USED MIKE LUDENS		█████ MADISON ST	WALWORTH	WI	53184	█████	01/31/99
03162	A-F	KVAPIL AUTO USED RICHARD T KVAPIL		█████ NICOLET ST	JANESVILLE	WI	53546	█████	01/31/99
03164	A-L	OHIO STREET MOTORS USED GEORGE H BURNETT		█████ OHIO ST	OSHKOSH	WI	54901	█████	03/31/98
03165	A-E	GRAMBORT RANDY SALES USED RANDY L GRAMBORT		█████ WILLOW DR	ABBOTSFORD	WI	54405	█████	01/31/99
03167	A-C	TIMBERLINE SALES USED PAUL KRUSE		█████ CASS ST	LA CROSSE	WI	54601	█████	01/31/99
03168	A-K	CROWN POINT CLASSICS USED GENE R WENDT		█████ HIGHWAY 51	HAZELHURST	WI	54531	█████	11/30/98
03169	A-P	NICK HARRINGS VALLEY VIEW FORD USED NICHOLAS R HARRING DENNIS M KOULA	NICK HARRINGS SELECT AUTO	█████ COPELAND AVENUE	LA CROSSE	WI	54601	█████	11/30/98
03170	A-D	BEMIS AUTO SALES USED ROBERT C BEMIS		█████ SHROEDER LANE	CRIVITZ	WI	54114	█████	07/31/97
03171	A-Q	HALLIE AUTO CENTER INC USED JAMES P HARTMAN DENNY C SHALHOOB IVY HARTMAN	KAR MART	█████ HALLIE RD	CHIPPEWA FALLS	WI	54729	█████	07/31/98
03172	A-J	1ST CHOICE AUTO INC USED RICHARD G COURCHAIINE ROBERT V SCHAMPERS		█████ VELD AVENUE	GREEN BAY	WI	54303	█████	03/31/99
03173	A-K	EDS AUTO USED EDWARD J EGGERS SR		█████ HWY 13	ARKDALE	WI	54613	█████	01/31/99
03174	A-K	MIDTOWN MOTORS USED MICHAEL P CULLIGAN		█████ W FULTON ST	WAUPACA	WI	54981	█████	01/31/99
03175	A-AJ	GREEN AUTOMOTIVE GROUP INC USED PAUL T KOLBECK TOM B GREEN	G A LEASING	█████ SO MAIN ST	JEFFERSON	WI	53549	█████	11/30/98

1999 WISCONSIN DEALER BOOK

03168	A-R	CHAMPION MOTORS USED DONALD E LAVRENZ		■ SOUTH MILITARY ROAD	FOND DU LAC	WI	54935	■	11/30
03159	B-E	PARCO AUTO SALES USED JOHN A PARELLO	STATELINE BODY & CHASSIS	■ ANTIOCH RD	TREVOR	WI	53179	■	11/30
03160	A-E	WAUNAKEE MOTORS USED MORRIS L MAXWELL		■ EAST MAIN	WAUNAKEE	WI	53597	■	01/31
03164	A-Q	OHIO STREET MOTORS USED GEORGE H BURNETT		■ OHIO ST	OSHKOSH	WI	54901	■	03/31
03165	A-G	GRAMBORT RANDY SALES USED RANDY L GRAMBORT		■ WILLOW DR	ABBOTSFORD	WI	54405	■	01/31
03167	A-E	TIMBERLINE AUTO SALES INC USED TANYA C KRUSE PAUL W KRUSE	JOHN R VAN VLEET	■ LANG DR	LA CROSSE	WI	54603	■	01/31
03168	A-K	CROWN POINT CLASSICS INC USED GENE R WENDT		■ HIGHWAY 51	HAZELHURST	WI	54531	■	11/30
03170	A-H	BEMIS AUTO SALES USED ROBERT C BEMIS		HWY 141	CRIVITZ	WI	54114	■	07/31
03171	A-Q	HALLIE AUTO CENTER INC USED JAMES P HARTMAN IVY HARTMAN	KAR MART	■ HALLIE RD	CHIPPEWA FALLS	WI	54729	■	07/31
03172	A-L	1ST CHOICE AUTO INC USED LINDA E SCHOMPERS ROBERT V SCHAMPERS		■ VELP AVENUE	GREEN BAY	WI	54303	■	03/31
03173	A-K	EDS AUTO USED EDWARD J EGGERS SR		■ HWY 13	ARKDALE	WI	54613	■	01/31
03174	A-K	MIDTOWN MOTORS USED MICHAEL P CULLIGAN		■ W FULTON ST	WAUPACA	WI	54981	■	01/31
03178	A-D	G & D AUTO USED CHAD GRIMM DAN WEILER		■ COUNTY ROAD E	ARPIN	WI	54410	■	09/30
03181	A-B	PEOTTERS MID CITY TRUCK AND AU USED JERRY VELIE JAMES R CRAWFORD		■ W WISCONSIN AVENUE	APPLETON	WI	54915	■	01/31
03182	A-D	MARKS AUTO BODY USED MARK A ECKES		■ HWY 10 E	MARSHFIELD	WI	54449	■	03/31
03183	A-B	M & I MARSHALL & ILSLEY BANK USED GARRY MARQUISS	M & I AUTOMOTIVE LEASING	■ N WATER ST	MILWAUKEE	WI	53202	■	03/31
03184	A-F	NICKS TRUCK REPAIR ROGER E NICKS		■ APPLE AVE	MEDFORD	WI	54451	■	03/31
03186	A-E	107 AUTO PARTS USED NEIL D CALLAHAN		■ HWY 107	MERRILL	WI	54452	■	03/31
03188	A-B	ENTERPRISE RENT-A-CAR CO INC USED JAMES R LOOMER		■ W COLLEGE AVENUE	APPLETON	WI	54912	■	07/31
03189	A-H	BUY BEST SALES USED GREGORY J HARBERTS		■ SOUTH BRIDGE STREET	CHIPPEWA FALLS	WI	54729	■	01/31

SUU 10,710,11, 116,010,00

INCIDENT CARD

1. INCIDENT: CRIMESTOPPER / 598-00242

5. INCIDENT LOCATION: [REDACTED]

6. NAME - LAST - FIRST - MI: ANONYMOUS / [REDACTED]

7. D.O.B.: [REDACTED]

8. ADDRESS: [REDACTED]

9. TX-HOME: [REDACTED]

10. TX-BUSINESS: [REDACTED]

11. CITY: [REDACTED] STATE: [REDACTED] ZIP: [REDACTED]

12. DETAILS: Rec'd info on 598-00242 14/03/01
 Susp veh eastside of I43
 betw River + CTH P. Parked
 in gully over a year.

1345
 2134
 12700
 1345
 2134
 12700
 1345

18. ASSIGNED: LT BUSHMAN 441

19. REC. BY: 441

20. DIS. BY:

21. HOW REC'D:
 1. 911
 2. POLICE RADIO
 3. PHONE
 4. TV
 5. IN PERSON
 6. ON VIEW
 7. OFF. OFF DUTY
 8. C.B. RADIO
 9. OTHER

22. TYPE OF REPORT:
 1. INCIDENT
 2. ACCIDENT
 3. CITATION
 4. NONE

23. STATUS:
 1. UNFOUNDED
 2. PNL
 3. OTHER
 4. CLEARED
 5. EXCEPT CLEARED

24. DATE CLEARED: 10/10/01

25. OFFENSE TYPE:
 1. ADULT NA
 2. JUVENILE
 3. UNKNOWN

ACTIVE

39. (CODE S-SUSPECT W-WITNESS V-VICTIM O-OTHER)						
CODE	40. NAME-LAST	FIRST	MI	41. D.O.B.	42. ADDRESS	43. TELEPHONE
O	VETTER	14700	BARRY	J	[REDACTED] N 44th St, Manitowoc	[REDACTED]

12/27/00 @ 1345 Hrs.: I, Lt. M. Bushman, met with the complainant in the front office of the Administrative building. [REDACTED] stated he regularly travels on I-43 and he has seen a full-sized Blazer parked in a gully alongside I-43, east side of the road, between the Manitowoc River and CTH P. He stated he first saw it about a year ago and it bothers him each time he goes by, wondering if it perhaps was the hit & run vehicle as it was a box-type Chevrolet Blazer.

12/30/00 @ 2134 Hrs.: I easily located the gully by the description given to me by [REDACTED]. After a short walk, I was able to observe the Chevy parked at a distance in a group of trees. The vehicle had WI RP CBZ482, last registered 09/98, on a 1977 Chevrolet. The vehicle was registered to BARRY VETTER of [REDACTED] N 44th St, Manitowoc.

Upon close inspection, there was no damage noted to the front grill area, and the vehicle was not consistent with the exact type of vehicle we were looking for. The headlights were round, and the grill work was old and had been in the vehicle for quite some time; however, it was an aftermarket-type grill, not original. The tire design on the vehicle also did not match, and the vehicle appeared to be sitting at this current location for quite some time.

This would definitely not be the vehicle we are looking for reference the hit & run.

MJBushman /bjc

45. IF COMPLAINANT DIFFERENT THEN CALLER, ENTER NAME, ADDRESS, D.O.B., TELEPHONE.

46. IF CODE O (OTHER) IS USED IN FIELD #39, EXPLAIN.

INCIDENT REPORT: NOTE: IF SECTION 22 ABOVE HAS NUMBER 4 CHECKED, DO NOT GO BEYOND THIS LINE WITHOUT RECORDS SECTION BEING ADVISED, OR NO RECORD ENTRIES WILL BE MADE BELOW THIS LINE.

PROPERTY VALUE	26. PROPERTY	A. CURRENCY	B. JEWELRY	C. FURS CLOTHING	D. VEHICLE (LOCAL)	E. OFFICE EQUIPMENT	F. RADIO, TV CAMERAS	G. FIREARMS	H. HOUSE-HOLD GOODS
	STOLEN	\$	\$	\$	\$	\$	\$	\$	\$
	RECOVERED	\$	\$	\$	\$	\$	\$	\$	\$
	26. PROPERTY	I. CONSUMABLES	J. LIVESTOCK	K. DRUGS	L. MARINE ITEMS	M. CONSTRUCTION ITEMS	N. LAWN AND GARDEN	O. SPORTING GOODS	P. MISC BICYCLE
	STOLEN	\$	\$	\$	\$	\$	\$	\$	\$
	RECOVERED	\$	\$	\$	\$	\$	\$	\$	\$

27. PROPERTY RECOVERED: LOCALLY _____ OTHER JURISDICTION _____ (INSERT O OR L)

PROPERTY ITEMIZATION	PROPERTY STOLEN/RECOVERED ITEMIZATION, USE THE FOLLOWING FORMAT				
	28. QUANTITY	29. ARTICLE NAME	30. BRAND NAME	31. SERIAL NUMBER	
					S <input type="checkbox"/> R <input type="checkbox"/>
					S <input type="checkbox"/> R <input type="checkbox"/>
					S <input type="checkbox"/> R <input type="checkbox"/>
					S <input type="checkbox"/> R <input type="checkbox"/>

33. PROPERTY DAMAGE AMOUNT \$ _____ 34. INSURANCE COMPANY _____

35. OFFICER ASSAULTED Y N 36. ARSON Y N 37. STRUCTURE CODE _____ 38. DAMAGE \$ _____

47. CIB <input type="checkbox"/>	ENTERED <input type="checkbox"/>	CANCELLED <input type="checkbox"/>	48. TOTAL AMOUNT PROPERTY STOLEN \$ _____
NCIC <input type="checkbox"/>	<input type="checkbox"/>	<input type="checkbox"/>	
OTHER BROADCAST <input type="checkbox"/>	<input type="checkbox"/>	<input type="checkbox"/>	
			49. TOTAL AMOUNT PROPERTY RECOVERED \$ _____

50. IS REPORT CONTINUED? YES NO 51. CAUTION INDICATORS, ATLS ETC.

52. DATA PROCESS INFORMATION:

COMPUTER ENTERED DATE 10/09/01

MICROFILM INDEXED INITIAL 52

IS CASE CLASSIFICATION CORRECT? IF N HAS CORRECTION BEEN MADE? Y N

53. FILE APPROVAL BY [Signature] DATE 10/03/01

S00 INE 01007 103011 152000

02-04-00 0938

4. INCIDENT CS / 599-00242

5. INCIDENT LOCATION

6. NAME - LAST - FIRST - MI mtso 7. D.O.B. (46)

8. ADDRESS

9. TX-HOME

11. CITY STATE ZIP 10. TX-BUSINESS

12. DETAILS
Recd info of an 86 Chevy TR
parked in parking lot on S.
9th St. across from Lates
Restaurant.

INCIDENT CARD

18. ASSIGNED MTSO 927
Glaeser 4117

19. REC. BY 901 20. DIS. BY -

21. HOW REC'D.
 1. 911
 2. POLICE RADIO
 3. PHONE
 4. TTY
 5. IN PERSON
 6. ON VIEW
 7. OFF. OFF DUTY
 8. C.B. RADIO
 9. OTHER

22. TYPE OF REPORT
 1. INCIDENT
 2. ACCIDENT
 3. CITATION
 4. NONE

23. STATUS
 1. UNFOUNDED
 2. PNL
 3. OTHER
 4. CLEARED
 5. EXCEPT CLEARED

24. DATE CLEARED 02/16/00

25. OFFENSE TYPE
 1. ADULT NA
 2. JUVENILE
 3. UNKNOWN

39. (CODE S-SUSPECT W-WITNESS V-VICTIM O-OTHER)	40. NAME - LAST	FIRST	MI	41. D.O.B.	42. ADDRESS	43. TELEPHONE
0	VAN	<u>ROBERT</u>	G	[REDACTED]	S 17th St. Manitowoc	[REDACTED]
0	FERRY	<u>DEAN</u>	J	[REDACTED]	Parkway Blvd. Two Rivers	[REDACTED]
0	BOTTERON	<u>CHRISTOPHER</u>	J	[REDACTED]	Candle Light Ct. Manitowoc	[REDACTED]

02-04-2000 @ 0938 hrs.: I, Deputy E. Glaeser, was given information from dispatch in regards to a suspect veh. matching the description of our hit & run profile. Dispatch informed me that Inspector Petersen requested we have an officer check a truck parked in the parking lot across from Late's in the old Richter Vinegar Co. property. Upon my arrival at that location, which would be [REDACTED] S. 9th St., City of Manitowoc, I did meet with the party who requested the check, MR. ROBERT VAN. VAN told me that he had recently purchased a 1986 Chevy 3/4 ton pickup truck and he wished that the veh. be checked over in regards to our hit & run inquiry.

In checking the veh., running the registration, and checking the VIN, it did indicate it was a 1986 Chevy Custom Deluxe, gray in color. The veh. displayed WI RP# CD54905 and did appear to be in refurbished condition. Inspecting the front end of the veh., I did note that it had a heavy duty plow assembly attached to the frame and front bumper area. I did note that the front grill area was consistent with our hit & run suspect veh. and in checking the plastic & chrome light trim pieces, it did appear that the screws had been replaced on those items and had been replaced with torques head screws. I did note that the inside screws holding the main grill frame to the front end did appear to be in a rusted condition. In further checking the veh., I did not note any damage to the fan shroud and in inspecting the right front end of the veh., it did appear that there was a possibility that the right front fender had been replaced, as it didn't show as much wear or rust as the left front fender.

In speaking to MR. ROBERT VAN, he indicated to me that he had recently purchased the veh. approx. 3 months ago from a party by the name of DEAN FERRY and at this time it was MR. VAN's request to find out if the veh. had been checked and compared to our hit & run profile. VAN did indicate to me who he bought the truck from and he said he had no idea how long MR. FERRY had the truck before he sold it to him. I did indicate to MR. VAN that it did appear the truck had been modified, but it was important at this time to speak to the former owner to find out when any modifications had been done to the truck.

At the time I was given this Crimestopper report, I was on my way into the department for court at 1000 hrs. and was unable to complete follow up on the first day. I will complete

S00 INE 01007

45. IF COMPLAINANT DIFFERENT THEN CALLER, ENTER NAME, ADDRESS, D.O.B., TELEPHONE.

46. IF CODE O (OTHER) IS USED IN FIELD #39, EXPLAIN.

INCIDENT REPORT: NOTE: IF SECTION 22 ABOVE HAS NUMBER 4 CHECKED, DO NOT GO BEYOND THIS LINE WITHOUT RECORDS SECTION BEING ADVISED, OR NO RECORD ENTRIES WILL BE MADE BELOW THIS LINE.

PROPERTY VALUE	26. PROPERTY	A. CURRENCY	B. JEWELRY	C. FURS CLOTHING	D. VEHICLE (LOCAL)	E. OFFICE EQUIPMENT	F. RADIO, TV CAMERAS	G. FIREARMS	H. HOUSE-HOLD GOODS
	STOLEN	\$	\$	\$	\$	\$	\$	\$	\$
	RECOVERED	\$	\$	\$	\$	\$	\$	\$	\$
	26. PROPERTY	I. CONSUM-ABLES	J. LIVESTOCK	K. DRUGS	L. MARINE ITEMS	M. CONSTRUCTION ITEMS	N. LAWN AND GARDEN	O. SPORTING GOODS	P. MISC BICYCLE
	STOLEN	\$	\$	\$	\$	\$	\$	\$	\$
	RECOVERED	\$	\$	\$	\$	\$	\$	\$	\$

27. PROPERTY RECOVERED: LOCALLY _____ OTHER JURISDICTION _____ (INSERT O OR L)

PROPERTY ITEMIZATION	PROPERTY STOLEN/RECOVERED ITEMIZATION, USE THE FOLLOWING FORMAT				
	28. QUANTITY	29. ARTICLE NAME	30. BRAND NAME	31. SERIAL NUMBER	32. CODE
					S R <input type="checkbox"/> <input type="checkbox"/>
					S R <input type="checkbox"/> <input type="checkbox"/>
					S R <input type="checkbox"/> <input type="checkbox"/>
					S R <input type="checkbox"/> <input type="checkbox"/>

33. PROPERTY DAMAGE AMOUNT \$ _____

34. INSURANCE COMPANY _____

35. OFFICER ASSAULTED Y N

36. ARSON Y N

37. STRUCTURE CODE _____ 38. DAMAGE \$ _____

47. CIB ENTERED CANCELLED
 NCIC
 OTHER BROADCAST

48. TOTAL AMOUNT PROPERTY STOLEN \$ _____

49. TOTAL AMOUNT PROPERTY RECOVERED \$ _____

50. IS REPORT CONTINUED? YES NO

51. CAUTION INDICATORS, ATLS ETC.

52. DATA PROCESS INFORMATION:

COMPUTER ENTERED DATE 2/16/00
 MICROFILM INDEXED INITIAL RS

53. FILE APPROVAL

IS CASE CLASSIFICATION CORRECT? Y N
 IF N HAS CORRECTION BEEN MADE? Y N

BY [Signature] DATE 2/16/00

MANITOWOC COUNTY SHERIFF'S DEPARTMENT
FOLLOW-UP REPORT

Page: 2

CASE NUMBER: S00-01007 CLASSIFICATION: _____

INCIDENT: _____

DATE AND TIME: _____

REPORT CONTINUED:

follow up on this incident on 02-05-00.

02-05-00 @ 0800 hrs.: I, Deputy E. Glaeser, did speak by telephone to MR. DEAN FERRY in regards to this incident. MR. FERRY acknowledged that he had recently sold the veh. to ROBERT VAN and when I questioned him in regards to any modifications he had done to the truck, he told me that the truck was in very good shape when he bought it in February of 1999 and the only modifications that he did to the truck was to put some sport stripes on the side of it. According to MR. FERRY, he bought the truck from a co-worker, and at this point he wasn't sure what the co-worker's name was. MR. FERRY did indicate that it was a strong likelihood that the old registration papers and purchase contract that had that particular party's name on it would be in the glove box of the truck. MR. DEAN FERRY told me that if I would call him back later in the morning, he would more than likely be able to provide that information.

02-05-00 @ 0820 hrs.: I, Deputy E. Glaeser, was recontacted by DEAN FERRY and he provided a name of CHRISTOPHER J. BOTTERON as the party he had purchased the veh. from in February of 1999. In speaking further with MR. FERRY, I asked him if he had put the hardware and assembly for a plow on the truck after he bought it, and he told me that all the plow hardware was on the truck when he purchased it from BOTTERON. FERRY was able to provide me with a phone # for CHRISTOPHER BOTTERON and he again stated he bought the truck from BOTTERON in February of 1999.

02-05-00 @ 1015 hrs.: I, Deputy E. Glaeser, made telephone contact with CHRISTOPHER BOTTERON. MR. BOTTERON acknowledged that he was the former owner of the 1986 Chevy Truck involved in this incident. BOTTERON told me that he did sell the veh. in February of 1999 to a DEAN FERRY, a party he worked with. According to BOTTERON, he did not do any body work on the veh. and the only alterations he made on the veh. through the entire time that he owned it was he put different tires on the truck. CHRISTOPHER BOTTERON told me that the torques head screws in the head light molding were apparently changed before he took possession of the truck and he stated that he could check his record, but he believed he bought the truck in October or November of 1997. BOTTERON said that the snow plow hook up and assembly was on the truck when he purchased it in 1997 and he never made any modifications to it. BOTTERON told me the did purchase the veh. from Terps and it was possible that Terps had done the body work prior to his taking possession of it.

Taking all this information into consideration and observing that the plow hardware and mounting assembly on the truck does appear to have been in a long standing state, that being covered with road grime and corrosion. It should be noted that even with a different set of tires on the truck, it would not match our suspect veh. profile and this particular veh. can be eliminated from our suspicion in our hit & run incident. Information on the veh. and the three parties I had contact with during this investigation will be entered into the FBI master computer. It should be noted that a check was made during this investigation and none of the parties were listed in the master file look up. EGlaeser/
klf

MANITOWOC COUNTY SHERIFF'S DEPARTMENT
FOLLOW-UP REPORT

Page: 3

CASE NUMBER: 500-01007 CLASSIFICATION: _____

INCIDENT: _____

DATE AND TIME: _____

REPORT CONTINUED:

It should also be noted that another subsequent check was made of the FBI program. It indicated this particular vehicle owned by CHRISTOPHER BOTTERON was checked in February 1999, indicating it was checked within a month of the accident. That particular entry indicated there was no damage on the vehicle.

No further action taken. EJGlaeser *ESTW* /bjc

S00 N2 01019 | 6,301 | \$ 2,000

INCIDENT CARD

4. INCIDENT
CS/S99-00242

5. INCIDENT LOCATION

6. NAME- LAST-FIRST-MI
Anonymous (2)

7. D.O.B.

8. ADDRESS

9. TX-HOME

10. TX-BUSINESS

11. CITY STATE ZIP

12. DETAILS
See Attached Sheet.

020400

00140200

14. REC'D	15. DISP	16. 10-23	17. 10-24
13. DAY			
SUN 1	THU 5		
MON 2	FRI 6		
TUE 3	SAT 7		
WED 4			

18. ASSIGNED
MISO 9 12 19

19. REC. BY
935

20. DIS. BY

21. HOW REC'D.
 1. 911
 2. POLICE RADIO
 3. PHONE
 4. TTY
 5. IN PERSON
 6. ON VIEW
 7. OFF. OFF DUTY
 8. C.B. RADIO
 9. OTHER

22. TYPE OF REPORT
 1. INCIDENT
 2. ACCIDENT
 3. CITATION
 4. NONE

23. STATUS
 1. UNFOUNDED
 2. PNL
 3. OTHER
 4. CLEARED
 5. EXCEPT CLEARED

24. DATE CLEARED
02/17/00

25. OFFENSE TYPE
 1. ADULT NA
 2. JUVENILE
 3. UNKNOWN

39. (CODE S-SUSPECT W-WITNESS V-VICTIM O-OTHER)						
CODE	40. NAME-LAST	FIRST	MI	41. D.O.B.	42. ADDRESS	43. TELEPHONE

020400 1533 hrs.: Officer Abler from MTPD checked veh. There would be no grill damage to vehicle. 935/lms

7

45. IF COMPLAINANT DIFFERENT THEN CALLER, ENTER NAME, ADDRESS, D.O.B., TELEPHONE.

46. IF CODE O (OTHER) IS USED IN FIELD #39, EXPLAIN.

INCIDENT REPORT: NOTE: IF SECTION 22 ABOVE HAS NUMBER 4 CHECKED, DO NOT GO BEYOND THIS LINE WITHOUT RECORDS SECTION BEING ADVISED, OR NO RECORD ENTRIES WILL BE MADE BELOW THIS LINE.

PROPERTY VALUE	26. PROPERTY	A. CURRENCY	B. JEWELRY	C. FURS CLOTHING	D. VEHICLE (LOCAL)	E. OFFICE EQUIPMENT	F. RADIO, TV CAMERAS	G. FIREARMS	H. HOUSE-HOLD GOODS
	STOLEN	\$	\$	\$	\$	\$	\$	\$	\$
	RECOVERED	\$	\$	\$	\$	\$	\$	\$	\$
	26. PROPERTY	I. CONSUM-ABLES	J. LIVESTOCK	K. DRUGS	L. MARINE ITEMS	M. CONSTRUCTION ITEMS	N. LAWN AND GARDEN	O. SPORTING GOODS	P. MISC BICYCLE
	STOLEN	\$	\$	\$	\$	\$	\$	\$	\$
	RECOVERED	\$	\$	\$	\$	\$	\$	\$	\$

27. PROPERTY RECOVERED: LOCALLY _____ OTHER JURISDICTION _____ (INSERT O OR L)

PROPERTY ITEMIZATION	PROPERTY STOLEN/RECOVERED ITEMIZATION, USE THE FOLLOWING FORMAT				
	28. QUANTITY	29. ARTICLE NAME	30. BRAND NAME	31. SERIAL NUMBER	32. CODE
					S <input type="checkbox"/> R <input type="checkbox"/>
					S <input type="checkbox"/> R <input type="checkbox"/>
					S <input type="checkbox"/> R <input type="checkbox"/>
					S <input type="checkbox"/> R <input type="checkbox"/>

33. PROPERTY DAMAGE AMOUNT \$ _____ 34. INSURANCE COMPANY _____

35. OFFICER ASSAULTED Y N 36. ARSON Y N 37. STRUCTURE CODE _____ 38. DAMAGE \$ _____

47. CIB	ENTERED <input type="checkbox"/>	CANCELLED <input type="checkbox"/>	48. TOTAL AMOUNT PROPERTY STOLEN \$ _____
NCIC	<input type="checkbox"/>	<input type="checkbox"/>	
OTHER BROADCAST	<input type="checkbox"/>	<input type="checkbox"/>	
			49. TOTAL AMOUNT PROPERTY RECOVERED \$ _____

50. IS REPORT CONTINUED? YES NO 51. CAUTION INDICATORS, ATLS ETC.

52. DATA PROCESS INFORMATION:

COMPUTER ENTERED DATE 12/17/00

MICROFILM INDEXED INITIAL KS

IS CASE CLASSIFICATION CORRECT? N

IF N HAS CORRECTION BEEN MADE? N

53. FILE APPROVAL

BY [Signature] DATE 12/17/00

1. CASE # **S00 No 00264** | 2. CLASSIFICATION **630.11** | 3. CENSUS **7.01000**

4. INCIDENT **CS/999-00242**

5. INCIDENT LOCATION

6. NAME - LAST - FIRST - MI **Anon** | 7. D.O.B.

8. ADDRESS | 9. TX-HOME

11. CITY | STATE | ZIP | 10. TX-BUSINESS

12. DETAILS **See Attached Worksheet**

09-00 1700

MANITOWOC COUNTY SHERIFF INCIDENT CARD

18. ASSIGNED **Information 98**

19. REC. BY **98** | 20. DIS. BY

21. HOW REC'D.
 1. 911
 2. POLICE RADIO
 3. PHONE
 4. TTY
 5. IN PERSON
 6. ON VIEW
 7. OFF. OFF DUTY
 8. C.B. RADIO
 9. OTHER

22. TYPE OF REPORT
 1. INCIDENT
 2. ACCIDENT
 3. CITATION
 4. NONE

23. STATUS
 1. UNFOUNDED
 2. PNL
 3. OTHER
 4. CLEARED
 5. EXCEPT CLEARED

24. DATE CLEARED **01/12/00**

25. OFFENSE TYPE
 1. ADULT NA
 2. JUVENILE
 3. UNKNOWN

13. DAY
 SUN 1 THU 5
 MON 2 FRI 6
 TUE 3 SAT 7
 WED 4

39. (CODE S-SUSPECT W-WITNESS V-VICTIM O-OTHER)				41. D.O.B.		42. ADDRESS		43. TELEPHONE	
CODE	40. NAME-LAST	FIRST	MI						
0	Mitchell, Robert E.								

01/10/00 @ 2030 Hrs.: MTSO received a Crime Stopper complaint about the RICK HOCHSTETLER hit and run accident. The caller stated there was a Chevy van with RP UFL164 which looked suspicious with a missing grill and replaced passenger door. The van was tan with a brown stripe, and it had a blue passenger door. The vehicle is being driven in the Baraboo area.

I, Lt. M. Bushman, made contact with Sgt. Schauf of Baraboo PD. He was advised of the Crime Stopper report, and I faxed him some details of the hit and run accident along with the Crime Stopper interview form. Sgt. Schauf advised me on the phone that he personally would make contact with the registered owner of the vehicle, ROBERT MITCHELL, who lives at [redacted] Oak St, Baraboo.

01/10/00 @ 2214 Hrs.: Sgt. Schauf called MTSO reference the request for follow-up. He met with the owner, ROBERT MITCHELL, and found the vehicle had been damaged in an incident in the City of Baraboo. The repairs made to the van did match the accident report filed on 03/08/99, Baraboo PD #99-1157. The damage was consistent with their report and not related to our hit and run.

This complaint can be closed out. MJBushman /bjc

CASE # S00 No 00264

45. IF COMPLAINANT DIFFERENT THEN CALLER, ENTER NAME, ADDRESS. D.O.B., TELEPHONE.

46. IF CODE O (OTHER) IS USED IN FIELD #39, EXPLAIN.

INCIDENT REPORT: NOTE: IF SECTION 22 ABOVE HAS NUMBER 4 CHECKED, DO NOT GO BEYOND THIS LINE WITHOUT RECORDS SECTION BEING ADVISED, OR NO RECORD ENTRIES WILL BE MADE BELOW THIS LINE.

PROPERTY VALUE	26. PROPERTY	A. CURRENCY	B. JEWELRY	C. FURS CLOTHING	D. VEHICLE (LOCAL)	E. OFFICE EQUIPMENT	F. RADIO, TV CAMERAS	G. FIREARMS	H. HOUSE-HOLD GOODS
	STOLEN	\$	\$	\$	\$	\$	\$	\$	\$
	RECOVERED	\$	\$	\$	\$	\$	\$	\$	\$
	26. PROPERTY	I. CONSUM-ABLES	J. LIVESTOCK	K. DRUGS	L. MARINE ITEMS	M. CONSTRUCTION ITEMS	N. LAWN AND GARDEN	O. SPORTING GOODS	P. MISC BICYCLE
	STOLEN	\$	\$	\$	\$	\$	\$	\$	\$
	RECOVERED	\$	\$	\$	\$	\$	\$	\$	\$

27. PROPERTY RECOVERED: LOCALLY _____ OTHER JURISDICTION _____ (INSERT O OR L)

PROPERTY ITEMIZATION	PROPERTY STOLEN/RECOVERED ITEMIZATION, USE THE FOLLOWING FORMAT				
	28. QUANTITY	29. ARTICLE NAME	30. BRAND NAME	31. SERIAL NUMBER	32. CODE
					S R <input type="checkbox"/> <input type="checkbox"/>
					S R <input type="checkbox"/> <input type="checkbox"/>
					S R <input type="checkbox"/> <input type="checkbox"/>
					S R <input type="checkbox"/> <input type="checkbox"/>

33. PROPERTY DAMAGE AMOUNT \$ _____ 34. INSURANCE COMPANY _____

35. OFFICER ASSAULTED Y N 36. ARSON Y N 37. STRUCTURE CODE _____ 38. DAMAGE \$ _____

47. CIB NCIC OTHER BROADCAST	ENTERED	CANCELLED	48. TOTAL AMOUNT PROPERTY STOLEN \$ _____
	<input type="checkbox"/>	<input type="checkbox"/>	
	<input type="checkbox"/>	<input type="checkbox"/>	
49. TOTAL AMOUNT PROPERTY RECOVERED \$ _____			

50. IS REPORT CONTINUED? YES NO

51. CAUTION INDICATORS, ATLS ETC.

52. DATA PROCESS INFORMATION:

COMPUTER ENTERED DATE 10/12/00
MICROFILM INDEXED INITIAL JS

53. FILE APPROVAL

IS CASE CLASSIFICATION CORRECT?
IF N HAS CORRECTION BEEN MADE? N

BY WRB DATE 10/12/00

Manitowoc County Sheriff's Department

Thomas H. Kocourek
SHERIFF



Kenneth J. Petersen
INSPECTOR



FAX

DATE 1-10-00

TO: Baraboo PD

FAX #: _____

FROM: LT Bushman

NUMBER OF PAGES SENT INCLUDING THIS ONE 3

CONFIDENTIALITY NOTICE

This message is intended only for the use of the individual or entity to which it is addressed and may contain information that is privileged, confidential, and exempt from disclosure under applicable law. If the reader of this message is not the intended recipient or the employee or agent responsible for delivering the message to the intended recipient, you are hereby notified that any dissemination, distribution, or copying of this communication is strictly prohibited. If you have received this communication in error, please notify us immediately by telephone and return the original message to us at the above address via the U.S. Postal Service. Thank you.

SHERIFF'S DEPT FAX NUMBERS: [REDACTED]

[REDACTED] - Detectives [REDACTED] - Dispatch [REDACTED] - Jail [REDACTED] - Juvenile
[REDACTED] - Metro [REDACTED] - Records/Administration

1. CASE # **S00 N# 00265** 2. CLASSIFICATION **6310.11** 3. CENSUS **5,210PP**

4. INCIDENT **CS / S99-00242**

5. INCIDENT LOCATION

6. NAME - LAST - FIRST - MI **ANONY.** 7. D.O.B. **(2)**

8. ADDRESS

9. TX-HOME

10. TX-BUSINESS

11. CITY STATE ZIP

12. DETAILS **See Attached.**

1745
01-09-00

14. REC'D	15. DISP	16. 10-23	17. 10-24
13. DAY			
SUN 1		THU 5	
MON 2		FRI 6	
TUE 3		SAT 7	
WED 4			

MANITOWOC COUNTY SHERIFF INCIDENT CARD

18. ASSIGNED **COLBORN** **41312**

19. REC. BY **938** 20. DIS. BY

21. HOW REC'D.
1. 911
2. POLICE RADIO
3. PHONE
4. TTY
5. ON PERSON
6. ON VIEW
7. OFF. OFF DUTY
8. C.B. RADIO
9. OTHER

22. TYPE OF REPORT
1. INCIDENT
2. ACCIDENT
3. CITATION
4. NONE

23. STATUS
1. UNFOUNDED
2. PNL
3. OTHER
4. CLEARED
5. EXCEPT CLEARED

24. DATE CLEARED **01/12/00**
25. OFFENSE TYPE
1. ADULT NA
2. JUVENILE
3. UNKNOWN

39. (CODE S-SUSPECT W-WITNESS V-VICTIM O-OTHER)					42. ADDRESS		43. TELEPHONE
CODE	40. NAME-LAST	FIRST	MI	41. C.O.B.			
0	KORINEK	THOMAS	D		Forest Home Dr, Francis Creek		

01/09/00: I, Deputy A. Colborn, responded to MTSO Jail Lobby where I made with a subject who at this time wishes to remain anonymous. The individual informed me he had a "gut feeling" that THOMAS KORINEK may be a suspect for the fatal hit and run from S99-00242.

The individual showed me some evidentiary type items that he felt may implicate KORINEK. After reviewing the items, I informed the individual that at this time, I did not feel the items that he showed me had any bearing on incident S99-00242. I informed him that I do not feel these items implicate KORINEK in that incident.

At this time, it does not appear KORINEK is a suspect in incident S99-00242. No further action taken at this time, pending new information and/or evidence implicating KORINEK and/or eliminating KORINEK as a suspect. A copy of this incident should be forwarded to Incident Commander, Lt. M. Bushman, upon completion of typing.

It should further be noted an alpha check through WI State Patrol was run. Results show no vehicle matching the description of the suspect vehicle for incident S99-00242 is registered to KORINEK (see attached results of alpha check). ALColborn /bjc

S00 N# 00265

45. IF COMPLAINANT DIFFERENT THEN CALLER, ENTER NAME, ADDRESS, D.O.B., TELEPHONE.

46. IF CODE O (OTHER) IS USED IN FIELD #39, EXPLAIN.

INCIDENT REPORT: NOTE: IF SECTION 22 ABOVE HAS NUMBER 4 CHECKED, DO NOT GO BEYOND THIS LINE WITHOUT RECORDS SECTION BEING ADVISED, OR NO RECORD ENTRIES WILL BE MADE BELOW THIS LINE.

PROPERTY VALUE	26. PROPERTY	A. CURRENCY	B. JEWELRY	C. FURS CLOTHING	D. VEHICLE (LOCAL)	E. OFFICE EQUIPMENT	F. RADIO, TV CAMERAS	G. FIREARMS	H. HOUSE-HOLD GOODS
	STOLEN	\$	\$	\$	\$	\$	\$	\$	\$
	RECOVERED	\$	\$	\$	\$	\$	\$	\$	\$
	26. PROPERTY	I. CONSUMABLES	J. LIVESTOCK	K. DRUGS	L. MARINE ITEMS	M. CONSTRUCTION ITEMS	N. LAWN AND GARDEN	O. SPORTING GOODS	P. MISC BICYCLE
	STOLEN	\$	\$	\$	\$	\$	\$	\$	\$
	RECOVERED	\$	\$	\$	\$	\$	\$	\$	\$

27. PROPERTY RECOVERED: LOCALLY ____ OTHER JURISDICTION ____ (INSERT O OR L)

PROPERTY ITEMIZATION	PROPERTY STOLEN/RECOVERED ITEMIZATION, USE THE FOLLOWING FORMAT				
	28. QUANTITY	29. ARTICLE NAME	30. BRAND NAME	31. SERIAL NUMBER	32. CODE
					S R <input type="checkbox"/> <input type="checkbox"/>
					S R <input type="checkbox"/> <input type="checkbox"/>
					S R <input type="checkbox"/> <input type="checkbox"/>
					S R <input type="checkbox"/> <input type="checkbox"/>
					S R <input type="checkbox"/> <input type="checkbox"/>

33. PROPERTY DAMAGE AMOUNT \$ _____ 34. INSURANCE COMPANY _____

35. OFFICER ASSAULTED Y N 36. ARSON Y N 37. STRUCTURE CODE _____ 38. DAMAGE \$ _____

47. CIB ENTERED CANCELLED
 NCIC
 OTHER BROADCAST

48. TOTAL AMOUNT PROPERTY STOLEN \$ _____

49. TOTAL AMOUNT PROPERTY RECOVERED \$ _____

50. IS REPORT CONTINUED? YES NO

51. CAUTION INDICATORS, ATLS ETC.

52. DATA PROCESS INFORMATION:

COMPUTER ENTERED DATE 11/12/00

MICROFILM INDEXED INITIAL *KS*

IS CASE CLASSIFICATION CORRECT?
 IF N HAS CORRECTION BEEN MADE?

Y N
 Y N

53. FILE APPROVAL

BY *[Signature]*

DATE 01/12/01

1. CASE # **S00 No 00270** | 2. CLASSIFICATION **6303** | 3. CENSUS **14011**

4. INCIDENT **CS/S99-00242 & CS/S99-00483**

5. INCIDENT LOCATION **CTH CR**

6. NAME-LAST-FIRST-MI **ANON** | 7. D.O.B.

8. ADDRESS | 9. TX-HOME

11. CITY | STATE | ZIP | 10. TX-BUSINESS

12. DETAILS
 Caller states that Brad R KUGEL m/w [REDACTED] owned the vehicle that struck and killed the Hochstetler boy. The suspect KUGEL runs a shop/dealership and does not register his vehicles. Would have to request his records.

2202 1-9-00

14. REC'D.	15. DISP	16. 10-23	17. 10-24
13. DAY			
SUN 1	THU 5		
MON 2	FRI 6		
TUE 3	SAT 7		
WED 4			

MANITOWOC COUNTY SHERIFF INCIDENT CARD

18. ASSIGNED **MITSO 929**

19. REC. BY **gab** | 20. DIS. BY

21. HOW REC'D.
 1. 911
 2. POLICE RADIO
 3. PHONE
 4. TTY
 5. IN PERSON
 6. ON VIEW
 7. OFF. OFF DUTY
 8. C.B. RADIO
 9. OTHER

22. TYPE OF REPORT
 1. INCIDENT
 2. ACCIDENT
 3. CITATION
 4. NONE

23. STATUS
 1. UNFOUNDED
 2. UNL
 3. OTHER
 4. CLEARED
 5. EXCEPT CLEARED

24. DATE CLEARED **15/7/00**

25. OFFENSE TYPE
 1. ADULT NA
 2. JUVENILE
 3. UNKNOWN

39. (CODE S-SUSPECT W-WITNESS V-VICTIM O-OTHER)				41. D.O.B.		42. ADDRESS		43. TELEPHONE	
CODE	40. NAME-LAST	FIRST	MI						

CASE No 00270

45. IF COMPLAINANT DIFFERENT THEN CALLER, ENTER NAME, ADDRESS, D.O.B., TELEPHONE.

46. IF CODE O (OTHER) IS USED IN FIELD #39, EXPLAIN.

INCIDENT REPORT: NOTE: IF SECTION 22 ABOVE HAS NUMBER 4 CHECKED, DO NOT GO BEYOND THIS LINE WITHOUT RECORDS SECTION BEING ADVISED, OR NO RECORD ENTRIES WILL BE MADE BELOW THIS LINE.

PROPERTY VALUE	26. PROPERTY	A. CURRENCY	B. JEWELRY	C. FURS CLOTHING	D. VEHICLE (LOCAL)	E. OFFICE EQUIPMENT	F. RADIO, TV CAMERAS	G. FIREARMS	H. HOUSE-HOLD GOODS
	STOLEN	\$	\$	\$	\$	\$	\$	\$	\$
	RECOVERED	\$	\$	\$	\$	\$	\$	\$	\$
	26. PROPERTY	I. CONSUM-ABLES	J. LIVESTOCK	K. DRUGS	L. MARINE ITEMS	M. CONSTRUCTION ITEMS	N. LAWN AND GARDEN	O. SPORTING GOODS	P. MISC BICYCLE
	STOLEN	\$	\$	\$	\$	\$	\$	\$	\$
	RECOVERED	\$	\$	\$	\$	\$	\$	\$	\$

27. PROPERTY RECOVERED: LOCALLY _____ OTHER JURISDICTION _____ (INSERT O OR L)

PROPERTY ITEMIZATION	PROPERTY STOLEN/RECOVERED ITEMIZATION, USE THE FOLLOWING FORMAT				
	28. QUANTITY	29. ARTICLE NAME	30. BRAND NAME	31. SERIAL NUMBER	32. CODE
					S R <input type="checkbox"/> <input type="checkbox"/>
					S R <input type="checkbox"/> <input type="checkbox"/>
					S R <input type="checkbox"/> <input type="checkbox"/>
					S R <input type="checkbox"/> <input type="checkbox"/>

33. PROPERTY DAMAGE AMOUNT \$ _____

34. INSURANCE COMPANY _____

35. OFFICER ASSAULTED Y N 36. ARSON Y N 37. STRUCTURE CODE _____ 38. DAMAGE \$ _____

47. CIB ENTERED CANCELLED
 NCIC
 OTHER BROADCAST

48. TOTAL AMOUNT PROPERTY STOLEN \$ _____

49. TOTAL AMOUNT PROPERTY RECOVERED \$ _____

50. IS REPORT CONTINUED? YES NO

51. CAUTION INDICATORS, ATLS ETC.

52. DATA PROCESS INFORMATION:

COMPUTER ENTERED DATE 15/17/08
 MICROFILM INDEXED INITIAL AS

53. FILE APPROVAL

IS CASE CLASSIFICATION CORRECT? N
 IF N HAS CORRECTION BEEN MADE? N

BY [Signature] DATE 05/16/08

1. CASE # **S00 N^o 00285** | 2. CLASSIFICATION **1a3011** | 3. CENSUS **140002**

4. INCIDENT **CS/S99-00242**
5. INCIDENT LOCATION

6. NAME - LAST - FIRST - MI **Anonymous** | 7. D.O.B.
8. ADDRESS | 9. TX-HOME

11. CITY | STATE | ZIP | 10. TX-BUSINESS

12. DETAILS
Owner of Astro Log Homes owned a Suburban until shortly after the HR and was reportedly in Mtwic that night and is a known drinker.

01/10/00 1338
01/02/00 110

MANITOWOC COUNTY SHERIFF INCIDENT CARD

18. ASSIGNED **WISO 929**
M. Bushman 441

19. REC. BY **920** | 20. DIS. BY
22. TYPE OF REPORT
1. INCIDENT
2. ACCIDENT
3. CITATION
4. NONE
23. STATUS
1. UNFOUNDED
2. PNL
3. OTHER
4. CLEARED
5. EXCEPT CLEARED
24. DATE CLEARED **1/5/00**
25. OFFENSE TYPE
1. ADULT NA
2. JUVENILE
3. UNKNOWN

39. (CODE S-SUSPECT W-WITNESS V-VICTIM O-OTHER)				42. ADDRESS		43. TELEPHONE
CODE	40. NAME-LAST	FIRST	MI	41. D.O.B.		

01/10/00 2143hrs Attempted contact with Jerry Dewane at [REDACTED] USH 151, Valders. There was a Cadillac in the driveway registered to him and a car in the garage, plate unknown. No lights on in the residence. Two dogs barked continuously while I was parked in the driveway but there was no response from the house. M.J. Bushman

01/14/00 2115hrs One set of vehicle tracks coming into the yard, lights on, dogs barking, call placed by phone from dispatch while I pounded on the door, no answer. M.J. Bushman

45. IF COMPLAINANT DIFFERENT THEN CALLER, ENTER NAME, ADDRESS, D.O.B., TELEPHONE.

46. IF CODE O (OTHER) IS USED IN FIELD #39, EXPLAIN.

INCIDENT REPORT: NOTE: IF SECTION 22 ABOVE HAS NUMBER 4 CHECKED, DO NOT GO BEYOND THIS LINE WITHOUT RECORDS SECTION BEING ADVISED, OR NO RECORD ENTRIES WILL BE MADE BELOW THIS LINE.

PROPERTY VALUE	26. PROPERTY	A. CURRENCY	B. JEWELRY	C. FURS CLOTHING	D. VEHICLE (LOCAL)	E. OFFICE EQUIPMENT	F. RADIO, TV CAMERAS	G. FIREARMS	H. HOUSE-HOLD GOODS
	STOLEN	\$	\$	\$	\$	\$	\$	\$	\$
	RECOVERED	\$	\$	\$	\$	\$	\$	\$	\$
	26. PROPERTY	I. CONSUMABLES	J. LIVESTOCK	K. DRUGS	L. MARINE ITEMS	M. CONSTRUCTION ITEMS	N. LAWN AND GARDEN	O. SPORTING GOODS	P. MISC BICYCLE
STOLEN	\$	\$	\$	\$	\$	\$	\$	\$	
RECOVERED	\$	\$	\$	\$	\$	\$	\$	\$	

27. PROPERTY RECOVERED: LOCALLY _____ OTHER JURISDICTION _____ (INSERT O OR L)

PROPERTY ITEMIZATION	PROPERTY STOLEN/RECOVERED ITEMIZATION, USE THE FOLLOWING FORMAT				
	28. QUANTITY	29. ARTICLE NAME	30. BRAND NAME	31. SERIAL NUMBER	32. CODE
					S R <input type="checkbox"/> <input type="checkbox"/>
					S R <input type="checkbox"/> <input type="checkbox"/>
					S R <input type="checkbox"/> <input type="checkbox"/>
					S R <input type="checkbox"/> <input type="checkbox"/>

33. PROPERTY DAMAGE AMOUNT \$ _____ 34. INSURANCE COMPANY _____

35. OFFICER ASSAULTED Y N 36. ARSON Y N 37. STRUCTURE CODE _____ 38. DAMAGE \$ _____

47. CIB	ENTERED <input type="checkbox"/>	CANCELLED <input type="checkbox"/>	48. TOTAL AMOUNT PROPERTY STOLEN \$ _____
NCIC	<input type="checkbox"/>	<input type="checkbox"/>	
OTHER BROADCAST	<input type="checkbox"/>	<input type="checkbox"/>	
			49. TOTAL AMOUNT PROPERTY RECOVERED \$ _____

50. IS REPORT CONTINUED? YES NO 51. CAUTION INDICATORS, ATLS ETC.

52. DATA PROCESS INFORMATION:

COMPUTER ENTERED DATE 15/17/00

MICROFILM INDEXED INITIAL *KS*

IS CASE CLASSIFICATION CORRECT? IF N HAS CORRECTION BEEN MADE? N N

53. FILE APPROVAL BY *R* DATE 05/16/00

1. CASE # **S00 N^o 00522** 2. CLASSIFICATION **6231071** 3. CENSUS **1H112**

4. INCIDENT **CS/S99-00272**

5. INCIDENT LOCATION **HWY CR**

6. NAME - LAST - FIRST - MI **Anonymous** 7. D.O.B.

8. ADDRESS 9. TX-HOME

11. CITY STATE ZIP 10. TX-BUSINESS

12. DETAILS **SEE ATTACHED.**

1-18-00 1435

**MANITOWOC COUNTY SHERIFF
INCIDENT CARD**

18. ASSIGNED **INFORMATION** **9/21/9**

MTSO **9/21/9**

19. REC. BY **939** 20. DIS. BY **-**

22. TYPE OF REPORT
 1. INCIDENT
 2. ACCIDENT
 3. CITATION
 4. NONE

21. HOW REC'D.
 1. 911
 2. POLICE RADIO
 3. PHONE
 4. TTY
 5. IN PERSON
 6. ON VIEW
 7. OFF. OFF DUTY
 8. C.B. RADIO
 9. OTHER

23. STATUS
 1. UNFOUNDED
 2. PNL
 3. OTHER
 4. CLEARED
 5. EXCEPT CLEARED

13. DAY
 SUN 1 THU 5
 MON 2 FRI 6
 TUE 3 SAT 7
 WED 4

24. DATE CLEARED **105/16/00**

25. OFFENSE TYPE
 1. ADULT NA
 2. JUVENILE
 3. UNKNOWN

21A. M.O.

39. (CODE S-SUSPECT W-WITNESS V-VICTIM O-OTHER)						
CODE	40. NAME-LAST	FIRST	MI	41. D.O.B.	42. ADDRESS	43. TELEPHONE

CASE # **S00 N^o 00522**

15-17-09

45. IF COMPLAINANT DIFFERENT THEN CALLER, ENTER NAME, ADDRESS, D.O.B., TELEPHONE.

46. IF CODE O (OTHER) IS USED IN FIELD #39, EXPLAIN.

INCIDENT REPORT: NOTE: IF SECTION 22 ABOVE HAS NUMBER 4 CHECKED, DO NOT GO BEYOND THIS LINE WITHOUT RECORDS SECTION BEING ADVISED, OR NO RECORD ENTRIES WILL BE MADE BELOW THIS LINE.

PROPERTY VALUE	26. PROPERTY	A. CURRENCY	B. JEWELRY	C. FURS CLOTHING	D. VEHICLE (LOCAL)	E. OFFICE EQUIPMENT	F. RADIO, TV CAMERAS	G. FIREARMS	H. HOUSE-HOLD GOODS
	STOLEN	\$	\$	\$	\$	\$	\$	\$	\$
	RECOVERED	\$	\$	\$	\$	\$	\$	\$	\$
	26. PROPERTY	I. CONSUMABLES	J. LIVESTOCK	K. DRUGS	L. MARINE ITEMS	M. CONSTRUCTION ITEMS	N. LAWN AND GARDEN	O. SPORTING GOODS	P. MISC BICYCLE
	STOLEN	\$	\$	\$	\$	\$	\$	\$	\$
	RECOVERED	\$	\$	\$	\$	\$	\$	\$	\$

27. PROPERTY RECOVERED: LOCALLY ____ OTHER JURISDICTION ____ (INSERT O OR L)

PROPERTY ITEMIZATION	PROPERTY STOLEN/RECOVERED ITEMIZATION, USE THE FOLLOWING FORMAT				
	28. QUANTITY	29. ARTICLE NAME	30. BRAND NAME	31. SERIAL NUMBER	32. CODE
					S R <input type="checkbox"/> <input type="checkbox"/>
					S R <input type="checkbox"/> <input type="checkbox"/>
					S R <input type="checkbox"/> <input type="checkbox"/>
					S R <input type="checkbox"/> <input type="checkbox"/>
					S R <input type="checkbox"/> <input type="checkbox"/>

33. PROPERTY DAMAGE AMOUNT \$ _____ 34. INSURANCE COMPANY _____

35. OFFICER ASSAULTED Y N 36. ARSON Y N 37. STRUCTURE CODE _____ 38. DAMAGE \$ _____

47. CIB	ENTERED <input type="checkbox"/>	CANCELLED <input type="checkbox"/>	48. TOTAL AMOUNT PROPERTY STOLEN \$ _____
NCIC	<input type="checkbox"/>	<input type="checkbox"/>	
OTHER BROADCAST	<input type="checkbox"/>	<input type="checkbox"/>	
49. TOTAL AMOUNT PROPERTY RECOVERED \$ _____			

50. IS REPORT CONTINUED? YES NO 51. CAUTION INDICATORS, ATLS ETC.

52. DATA PROCESS INFORMATION:

COMPUTER ENTERED DATE 15/17/09

MICROFILM INDEXED INITIAL KS

IS CASE CLASSIFICATION CORRECT? Y N

IF N HAS CORRECTION BEEN MADE? Y N

53. FILE APPROVAL

BY [Signature] DATE 05/16/09

1. CASE # **S00 No 00680** 2. CLASSIFICATION **6,3|0,1|** 3. CENSUS **5,2|0,0,0**

4. INCIDENT **CS/S99-00242**

5. INCIDENT LOCATION

6. NAME - LAST - FIRST - MI **Anonymous** 7. D.O.B. **2**

8. ADDRESS 9. TX-HOME

11. CITY STATE ZIP 10. TX-BUSINESS

12. DETAILS.
Details with information on a possible suspect.

012400 1350
 REC'D 14. 15. 16. 17.
 DISP 10-23 10-24
 13. DAY
 SUN 1 THU 5
~~MON 2~~ FRI 6
 TUE 3 SAT 7
 WED 4

MANITOWOC COUNTY SHERIFF INCIDENT CARD

18. ASSIGNED
MTSO Crime Stpr 923

19. REC. BY **923** 20. DIS. BY

21. HOW REC'D.
 1. 911
 2. POLICE RADIO
 3. PHONE
 4. TTY
 5. IN PERSON
 6. ON VIEW
 7. OFF. OFF DUTY
 8. C.B. RADIO
 9. OTHER

22. TYPE OF REPORT
 INCIDENT
 ACCIDENT
 CITATION
 NONE

23. STATUS
 UNFOUNDED
 PNL
 OTHER
 CLEARED
 EXCEPT CLEARED

24. DATE CLEARED **10/17/00**

25. OFFENSE TYPE
 1. ADULT NA
 2. JUVENILE
 3. UNKNOWN

21A.M.O.

39. (CODE S-SUSPECT W-WITNESS V-VICTIM O-OTHER)				41. D.O.B.		42. ADDRESS		43. TELEPHONE	
CODE	40.NAME-LAST	FIRST	MI						

CASE # No 00680

012002 304

45. IF COMPLAINANT DIFFERENT THEN CALLER, ENTER NAME, ADDRESS, D.O.B., TELEPHONE.

46. IF CODE O (OTHER) IS USED IN FIELD #39, EXPLAIN.

INCIDENT REPORT: NOTE: IF SECTION 22 ABOVE HAS NUMBER 4 CHECKED, DO NOT GO BEYOND THIS LINE WITHOUT RECORDS SECTION BEING ADVISED, OR NO RECORD ENTRIES WILL BE MADE BELOW THIS LINE.

PROPERTY VALUE	26. PROPERTY	A. CURRENCY	B. JEWELRY	C. FURS CLOTHING	D. VEHICLE (LOCAL)	E. OFFICE EQUIPMENT	F. RADIO, TV CAMERAS	G. FIREARMS	H. HOUSEHOLD GOODS
	STOLEN	\$	\$	\$	\$	\$	\$	\$	\$
	RECOVERED	\$	\$	\$	\$	\$	\$	\$	\$
	26. PROPERTY	I. CONSUMABLES	J. LIVESTOCK	K. DRUGS	L. MARINE ITEMS	M. CONSTRUCTION ITEMS	N. LAWN AND GARDEN	O. SPORTING GOODS	P. MISC BICYCLE
	STOLEN	\$	\$	\$	\$	\$	\$	\$	\$
	RECOVERED	\$	\$	\$	\$	\$	\$	\$	\$

27. PROPERTY RECOVERED: LOCALLY _____ OTHER JURISDICTION _____ (INSERT O OR L)

PROPERTY ITEMIZATION	PROPERTY STOLEN/RECOVERED ITEMIZATION, USE THE FOLLOWING FORMAT				
	28. QUANTITY	29. ARTICLE NAME	30. BRAND NAME	31. SERIAL NUMBER	32. CODE
					S R <input type="checkbox"/> <input type="checkbox"/>
					S R <input type="checkbox"/> <input type="checkbox"/>
					S R <input type="checkbox"/> <input type="checkbox"/>
					S R <input type="checkbox"/> <input type="checkbox"/>
					S R <input type="checkbox"/> <input type="checkbox"/>

33. PROPERTY DAMAGE AMOUNT \$ _____

34. INSURANCE COMPANY _____

35. OFFICER ASSAULTED Y N

36. ARSON Y N

37. STRUCTURE CODE _____

38. DAMAGE \$ _____

47. CIB ENTERED CANCELLED
 NCIC
 OTHER BROADCAST

48. TOTAL AMOUNT PROPERTY STOLEN \$ _____

49. TOTAL AMOUNT PROPERTY RECOVERED \$ _____

50. IS REPORT CONTINUED? YES NO

51. CAUTION INDICATORS, ATLS ETC.

52. DATA PROCESS INFORMATION:

COMPUTER ENTERED DATE 15/17/00
 MICROFILM INDEXED INITIAL KS

IS CASE CLASSIFICATION CORRECT?
 IF N HAS CORRECTION BEEN MADE?
 Y N

53. FILE APPROVAL

BY KS DATE 05/16/00

1. CASE # S00 No 00899 2. CLASSIFICATION 63011 3. CENSUS 14011

4. INCIDENT CS 1599-00242

5. INCIDENT LOCATION CTH CR 5 of Silver Creek

6. NAME - LAST - FIRST - MI Ford Dilac PD 7. D.O.B.

8. ADDRESS 9. TX-HOME

11. CITY STATE ZIP 10. TX-BUSINESS

12. DETAILS
 Officer Larden has info for possible suspect veh see attached

2015 1-31-00

MANITOWOC COUNTY SHERIFF INCIDENT CARD

18. ASSIGNED Lenk 21014

19. REC'D BY [Signature] 20. DIS. BY

21. HOW REC'D.
 1. 911
 2. POLICE RADIO
 3. PHONE
 4. TTY
 5. IN PERSON
 6. ON VIEW
 7. OFF. OFF DUTY
 8. C.B. RADIO
 9. OTHER

22. TYPE OF REPORT
 1. INCIDENT
 2. ACCIDENT
 3. CITATION
 4. NONE

23. STATUS
 1. UNFOUNDED
 2. RNL
 3. OTHER
 4. CLEARED
 5. EXCEPT CLEARED

24. DATE CLEARED 01/31/00
 25. OFFENSE TYPE
 1. ADULT NA
 2. JUVENILE
 3. UNKNOWN

14. REC'D 15. DISP 16. 10-23 17. 10-24
 13. DAY
 SUN 1 THU 5
 MON 2 FRI 6
 TUE 3 SAT 7
 WED 4

39. (CODE S-SUSPECT W-WITNESS V-VICTIM O-OTHER)						
CODE	40. NAME-LAST	FIRST	MI	41. D.O.B.	42. ADDRESS	43. TELEPHONE

This Crime Stopper is in reference to S99-00242, the hit and run of RICHARD HOCHSTETLER. The questionable vehicle in this Crime Stopper is a Chevy van, white in color, with front end damage. This vehicle is not consistent with what the FBI has considered for the suspect vehicle. This Crime Stopper can be considered closed. JMLenk /bjc

CASE # S00 No 00899

67000 517

45. IF COMPLAINANT DIFFERENT THEN CALLER, ENTER NAME, ADDRESS, D.O.B., TELEPHONE.

46. IF CODE O (OTHER) IS USED IN FIELD #39, EXPLAIN.

INCIDENT REPORT: NOTE: IF SECTION 22 ABOVE HAS NUMBER 4 CHECKED, DO NOT GO BEYOND THIS LINE WITHOUT RECORDS SECTION BEING ADVISED, OR NO RECORD ENTRIES WILL BE MADE BELOW THIS LINE.

PROPERTY VALUE	26. PROPERTY	A. CURRENCY	B. JEWELRY	C. FURS CLOTHING	D. VEHICLE (LOCAL)	E. OFFICE EQUIPMENT	F. RADIO, TV CAMERAS	G. FIREARMS	H. HOUSE-HOLD GOODS
	STOLEN	\$	\$	\$	\$	\$	\$	\$	\$
	RECOVERED	\$	\$	\$	\$	\$	\$	\$	\$
	26. PROPERTY	I. CONSUM-ABLES	J. LIVESTOCK	K. DRUGS	L. MARINE ITEMS	M. CONSTRUCTION ITEMS	N. LAWN AND GARDEN	O. SPORTING GOODS	P. MISC BICYCLE
	STOLEN	\$	\$	\$	\$	\$	\$	\$	\$
	RECOVERED	\$	\$	\$	\$	\$	\$	\$	\$

27. PROPERTY RECOVERED: LOCALLY _____ OTHER JURISDICTION _____ (INSERT O OR L)

PROPERTY ITEMIZATION	PROPERTY STOLEN/RECOVERED ITEMIZATION, USE THE FOLLOWING FORMAT			
	28. QUANTITY	29. ARTICLE NAME	30. BRAND NAME	31. SERIAL NUMBER

32. CODE
 S R
 S R
 S R
 S R
 S R
 S R

33. PROPERTY DAMAGE AMOUNT \$ _____

34. INSURANCE COMPANY _____

35. OFFICER ASSAULTED Y N

36. ARSON Y N

37. STRUCTURE CODE _____

38. DAMAGE \$ _____

47. CIB ENTERED CANCELLED
 NCIC
 OTHER BROADCAST

48. TOTAL AMOUNT PROPERTY STOLEN \$ _____

49. TOTAL AMOUNT PROPERTY RECOVERED \$ _____

50. IS REPORT CONTINUED? YES NO

51. CAUTION INDICATORS, ATLS ETC.

52. DATA PROCESS INFORMATION:

COMPUTER ENTERED DATE 9.16.09
 MICROFILM INDEXED INITIAL KS
 IS CASE CLASSIFICATION CORRECT? Y N
 IF N HAS CORRECTION BEEN MADE? Y N

53. FILE APPROVAL

BY [Signature] DATE 8/31/09

45. IF COMPLAINANT DIFFERENT THEN CALLER, ENTER NAME, ADDRESS, D.O.B., TELEPHONE.

46. IF CODE O (OTHER) IS USED IN FIELD #39, EXPLAIN.

INCIDENT REPORT: NOTE: IF SECTION 22 ABOVE HAS NUMBER 4 CHECKED, DO NOT GO BEYOND THIS LINE WITHOUT RECORDS SECTION BEING ADVISED, OR NO RECORD ENTRIES WILL BE MADE BELOW THIS LINE.

PROPERTY VALUE	26. PROPERTY	A. CURRENCY	B. JEWELRY	C. FURS CLOTHING	D. VEHICLE (LOCAL)	E. OFFICE EQUIPMENT	F. RADIO, TV CAMERAS	G. FIREARMS	H. HOUSE-HOLD GOODS
	STOLEN	\$	\$	\$	\$	\$	\$	\$	\$
	RECOVERED	\$	\$	\$	\$	\$	\$	\$	\$
	26. PROPERTY	I. CONSUMABLES	J. LIVESTOCK	K. DRUGS	L. MARINE ITEMS	M. CONSTRUCTION ITEMS	N. LAWN AND GARDEN	O. SPORTING GOODS	P. MISC BICYCLE
	STOLEN	\$	\$	\$	\$	\$	\$	\$	\$
	RECOVERED	\$	\$	\$	\$	\$	\$	\$	\$

27. PROPERTY RECOVERED: LOCALLY _____ OTHER JURISDICTION _____ (INSERT O OR L)

PROPERTY ITEMIZATION	PROPERTY STOLEN/RECOVERED ITEMIZATION, USE THE FOLLOWING FORMAT				
	28. QUANTITY	29. ARTICLE NAME	30. BRAND NAME	31. SERIAL NUMBER	32. CODE
					S R <input type="checkbox"/> <input type="checkbox"/>
					S R <input type="checkbox"/> <input type="checkbox"/>
					S R <input type="checkbox"/> <input type="checkbox"/>
					S R <input type="checkbox"/> <input type="checkbox"/>
					S R <input type="checkbox"/> <input type="checkbox"/>

33. PROPERTY DAMAGE AMOUNT \$ _____

34. INSURANCE COMPANY _____

35. OFFICER ASSAULTED Y N 36. ARSON Y N 37. STRUCTURE CODE _____ 38. DAMAGE \$ _____

47. CIB ENTERED CANCELLED
 NCIC
 OTHER BROADCAST

48. TOTAL AMOUNT PROPERTY STOLEN \$ _____

49. TOTAL AMOUNT PROPERTY RECOVERED \$ _____

50. IS REPORT CONTINUED? YES NO

51. CAUTION INDICATORS, ATLS ETC.

52. DATA PROCESS INFORMATION:

COMPUTER ENTERED DATE 01/29/01

MICROFILM INDEXED INITIAL GP

IS CASE CLASSIFICATION CORRECT?
 IF N HAS CORRECTION BEEN MADE? N

53. FILE APPROVAL

BY WPKS DATE 01/29/01

501-00203 163011 114012

4. INCIDENT
CS / SEE 599-00242

5. INCIDENT LOCATION
CTH CR

6. NAME - LAST - FIRST - MI
[REDACTED] (43828) 7. D.O.B. [REDACTED]

8. ADDRESS [REDACTED] 9. TX-HOME [REDACTED]

11. CITY STATE ZIP 10. TX-BUSINESS
MANITOWOC

12. DETAILS
COMPL. REPORTS FOR INFORMATION
HE HAS OBSERVED A SUSPECT
VEHICLE IN THE HOCHSTETLER HER
INCIDENT. SEE ATTACHED.

1130 01-09-01

INCIDENT CARD

18. ASSIGNED
MTSO 929

Leak 2104

19. REC. BY 20. DIS. BY
930 930

21. HOW REC'D.
1. 911
2. POLICE RADIO
3. PHONE
4. TTY
5. IN PERSON
6. ON VIEW
7. OFF. OFF DUTY
8. C.B. RADIO
9. OTHER

22. TYPE OF REPORT
 INCIDENT
2. ACCIDENT
3. CITATION
4. NONE

23. STATUS
1. UNFOUNDED
2. PNL
3. OTHER
4. CLEARED
5. EXCEPT CLEARED

24. DATE CLEARED
12/01/01

25. OFFENSE TYPE
1. ADULT NA
2. JUVENILE
3. UNKNOWN

21A. M.O.

ACTIVE

39. (CODE S-SUSPECT W-WITNESS V-VICTIM O-OTHER)						
CODE	40. NAME-LAST	FIRST	MI	41. D.O.B.	42. ADDRESS	43. TELEPHONE
O	PETERS	19203	JAMES	E	[REDACTED] CTH CR, Manitowoc	

This vehicle was previously examined in January 1999 (see incident S99-00616). This is not the suspect vehicle we are looking for. JMLenk *JMLenk* /bjc

45. IF COMPLAINANT DIFFERENT THEN CALLER, ENTER NAME, ADDRESS, D.O.B., TELEPHONE.

46. IF CODE O (OTHER) IS USED IN FIELD #39, EXPLAIN.

INCIDENT REPORT: NOTE: IF SECTION 22 ABOVE HAS NUMBER 4 CHECKED, DO NOT GO BEYOND THIS LINE WITHOUT RECORDS SECTION BEING ADVISED, OR NO RECORD ENTRIES WILL BE MADE BELOW THIS LINE.

PROPERTY VALUE	26. PROPERTY	A. CURRENCY	B. JEWELRY	C. FURS CLOTHING	D. VEHICLE (LOCAL)	E. OFFICE EQUIPMENT	F. RADIO, TV CAMERAS	G. FIREARMS	H. HOUSE-HOLD GOODS
	STOLEN	\$	\$	\$	\$	\$	\$	\$	\$
	RECOVERED	\$	\$	\$	\$	\$	\$	\$	\$
	26. PROPERTY	I. CONSUMABLES	J. LIVESTOCK	K. DRUGS	L. MARINE ITEMS	M. CONSTRUCTION ITEMS	N. LAWN AND GARDEN	O. SPORTING GOODS	P. MISC BICYCLE
STOLEN	\$	\$	\$	\$	\$	\$	\$	\$	
RECOVERED	\$	\$	\$	\$	\$	\$	\$	\$	

27. PROPERTY RECOVERED: LOCALLY _____ OTHER JURISDICTION _____ (INSERT O OR L)

PROPERTY ITEMIZATION	PROPERTY STOLEN/RECOVERED ITEMIZATION, USE THE FOLLOWING FORMAT				
	28. QUANTITY	29. ARTICLE NAME	30. BRAND NAME	31. SERIAL NUMBER	32. CODE
					S R <input type="checkbox"/> <input type="checkbox"/>
					S R <input type="checkbox"/> <input type="checkbox"/>
					S R <input type="checkbox"/> <input type="checkbox"/>
					S R <input type="checkbox"/> <input type="checkbox"/>

33. PROPERTY DAMAGE AMOUNT \$ _____ 34. INSURANCE COMPANY _____

35. OFFICER ASSAULTED Y N 36. ARSON Y N 37. STRUCTURE CODE _____ 38. DAMAGE \$ _____

47. CIB	ENTERED <input type="checkbox"/>	CANCELLED <input type="checkbox"/>	48. TOTAL AMOUNT PROPERTY STOLEN \$ _____
NCIC	<input type="checkbox"/>	<input type="checkbox"/>	
OTHER BROADCAST	<input type="checkbox"/>	<input type="checkbox"/>	
			49. TOTAL AMOUNT PROPERTY RECOVERED \$ _____

50. IS REPORT CONTINUED? YES NO

51. CAUTION INDICATORS, ATLS ETC.

52. DATA PROCESS INFORMATION:

COMPUTER ENTERED DATE 10/20/01
 MICROFILM INDEXED INITIAL RS

53. FILE APPROVAL

IS CASE CLASSIFICATION CORRECT?
 IF N HAS CORRECTION BEEN MADE? Y N

BY [Signature] DATE 10/01/01

S01 INZ 00120 5778 1141011

4. INCIDENT: CS 599-00242 6301

5. INCIDENT LOCATION: CTH CR

6. NAME - LAST - FIRST - MI: ANONYMOUS (2) 7. D.O.B.

8. ADDRESS 9. TX-HOME

11. CITY STATE ZIP 10. TX-BUSINESS

12. DETAILS: CALLER GAVE INFO THAT A SCHINDLER, THOMAS O. (13246) WAS DRIVING A WHITE BLAZER IN THAT DIRECTION THE NOC OF THE FATAL

1991
01-28-01

INCIDENT CARD

18. ASSIGNED: ALL 4010
MT50 929
Glaeser 4117

19. REC. BY: 946 20. DIS. BY: -

21. HOW REC'D.: 1. 911 2. POLICE RADIO 3. PHONE 4. TTY 5. IN PERSON 6. ON VIEW 7. OFF. OFF DUTY 8. C.B. RADIO 9. OTHER

22. TYPE OF REPORT: 1. INCIDENT 2. ACCIDENT 3. CITATION 4. NONE

23. STATUS: 1. UNFOUNDED 2. PNL 3. OTHER 4. CLEARED 5. EXCEPT CLEARED

24. DATE CLEARED: DSP 2-16-01

25. OFFENSE TYPE: 1. ADULT NA 2. JUVENILE 3. UNKNOWN

14. REC'D 15. DISP 16. 10-23 17. 10-24

13. DAY: SUN 1 THU 5, MON 2 FRI 6, TUE 3 SAT 7, WED 4

39. (CODE S-SUSPECT W-WITNESS V-VICTIM O-OTHER)	40. NAME-LAST	FIRST	MI	41. D.O.B.	42. ADDRESS	43. TELEPHONE
O	SCHINDLER	THOMAS	O		E Harding Dr #3, Appleton	
O	ZIPPERER	GEORGE	B		CTH B, Manitowoc	
O	SCHISEL	SALLY	K		Hamilton St, Manitowoc	

05/10/01 @ 1130 Hrs.: I, Deputy E. Glaeser, was assigned to follow-up on this Crime Stoppers report. In checking the information, it indicated that [redacted] heard information from [redacted] that THOMAS SCHINDLER was going home in the direction of the fatal accident that happened in Manitowoc Co. along CTH CR near Silver Creek Rd.

I checked our in-house FBI file. It did not provide any information on THOMAS SCHINDLER. A check was made of in-house records, and it showed an Appleton address for SCHINDLER but no phone number. In checking with State Patrol, Dispatch provided an alpha check and according to the State Patrol, they listed no vehicles to SCHINDLER. In checking with Information, they provided a telephone number for SCHINDLER from Menasha.

I made numerous attempts to contact SCHINDLER but was unsuccessful.

An attempt was made to contact [redacted]. After several attempts at contacting him, I was unsuccessful.

05/15/01 @ 0945 Hrs.: I spoke to [redacted] in regard to this complaint. [redacted] told me that she had been given the information about SCHINDLER being a suspect from [redacted]. She relayed that [redacted] could confirm the information.

05/16/01 @ 0740 Hrs.: I was contacted by [redacted] in regard to this complaint. I questioned [redacted] about any information he may have on SCHINDLER operating the vehicle as reported by an anonymous complainant. [redacted] told me that was report was false and that he had no information whatsoever about SCHINDLER. He did not have any idea who would have reported such a matter. I asked [redacted] if he ever said anything about SCHINDLER possibly driving a white Blazer on the night of the fatal 10-50 on 01/10/99 on CTH CR. [redacted] told me he had absolutely no information and he did not want to take a guess at who may have been responsible for that incident. [redacted] further relayed to me that he never made any statements in regard to any speculation about anyone being responsible for driving the suspect vehicle on the night in question.

45. IF COMPLAINANT DIFFERENT THEN CALLER, ENTER NAME, ADDRESS, D.O.B., TELEPHONE.

46. IF CODE O (OTHER) IS USED IN FIELD #39, EXPLAIN.

INCIDENT REPORT: NOTE: IF SECTION 22 ABOVE HAS NUMBER 4 CHECKED, DO NOT GO BEYOND THIS LINE WITHOUT RECORDS SECTION BEING ADVISED, OR NO RECORD ENTRIES WILL BE MADE BELOW THIS LINE.

PROPERTY VALUE	26. PROPERTY	A. CURRENCY	B. JEWELRY	C. FURS CLOTHING	D. VEHICLE (LOCAL)	E. OFFICE EQUIPMENT	F. RADIO, TV CAMERAS	G. FIREARMS	H. HOUSE-HOLD GOODS
	STOLEN	\$	\$	\$	\$	\$	\$	\$	\$
	RECOVERED	\$	\$	\$	\$	\$	\$	\$	\$
	26. PROPERTY	I. CONSUM-ABLES	J. LIVESTOCK	K. DRUGS	L. MARINE ITEMS	M. CONSTRUCTION ITEMS	N. LAWN AND GARDEN	O. SPORTING GOODS	P. MISC BICYCLE
	STOLEN	\$	\$	\$	\$	\$	\$	\$	\$
	RECOVERED	\$	\$	\$	\$	\$	\$	\$	\$

27. PROPERTY RECOVERED: LOCALLY _____ OTHER JURISDICTION _____ (INSERT O OR L)

PROPERTY ITEMIZATION	PROPERTY STOLEN/RECOVERED ITEMIZATION, USE THE FOLLOWING FORMAT				31. SERIAL NUMBER	32. CODE		
	28. QUANTITY	29. ARTICLE NAME	30. BRAND NAME			S	R	
							<input type="checkbox"/>	<input type="checkbox"/>
							<input type="checkbox"/>	<input type="checkbox"/>
							<input type="checkbox"/>	<input type="checkbox"/>
							<input type="checkbox"/>	<input type="checkbox"/>
							<input type="checkbox"/>	<input type="checkbox"/>

33. PROPERTY DAMAGE AMOUNT \$ _____ 34. INSURANCE COMPANY _____

35. OFFICER ASSAULTED Y N 36. ARSON Y N 37. STRUCTURE CODE _____ 38. DAMAGE \$ _____

47. CIB	ENTERED <input type="checkbox"/>	CANCELLED <input type="checkbox"/>	48. TOTAL AMOUNT PROPERTY STOLEN \$ _____
NCIC	<input type="checkbox"/>	<input type="checkbox"/>	
OTHER BROADCAST	<input type="checkbox"/>	<input type="checkbox"/>	
			49. TOTAL AMOUNT PROPERTY RECOVERED \$ _____

50. IS REPORT CONTINUED? YES NO 51. CAUTION INDICATORS, ATLS ETC.

52. DATA PROCESS INFORMATION:

COMPUTER ENTERED DATE 5/30/11

MICROFILM INDEXED INITIAL KS

IS CASE CLASSIFICATION CORRECT? Y N

IF N HAS CORRECTION BEEN MADE? Y N

53. FILE APPROVAL

BY JmL DATE 6/22/11

S01. NO 00126 571.8 11401.1

01-28-01 194

INCIDENT CARD

4. INCIDENT
CS 599-00242

5. INCIDENT LOCATION
CTN CR

6. NAME - LAST-FIRST-MI
Anonymous (2)

7. D.O.B.

8. ADDRESS

9. TX-HOME

10. TX-BUSINESS

11. CITY STATE ZIP

18. ASSIGNED
ALL 4010

12. DETAILS
CALLER GAVE INFO THAT A
SCHINDLER, THOMAS (13246) [REDACTED]
WAS DRIVING A WHITE BLAZER
IN THAT DIRECTION THE NOC OF
THE FATAL

14. REC'D
15. DISP
16. 10-23
17. 10-24

13. DAY
SUN (1) THU 5
MON 2 FRI 6
TUE 3 SAT 7
WED 4

19. REC. BY
946

20. DIS. BY

21. HOW REC'D.
1. 911
2. POLICE RADIO
3. PHONE
4. TTY
5. IN PERSON
6. ON VIEW
7. OFF. OFF DUTY
8. C.B. RADIO
9. OTHER

22. TYPE OF REPORT
1. INCIDENT
2. ACCIDENT
3. CITATION
4. NONE

23. STATUS
1. UNFOUNDED
2. PNL
3. OTHER
4. CLEARED
5. EXCEPT CLEARED

24. DATE CLEARED

25. OFFENSE TYPE
1. ADULT NA
2. JUVENILE
3. UNKNOWN

39. (CODE S-SUSPECT W-WITNESS V-VICTIM O-OTHER)						
CODE	40. NAME-LAST	FIRST	MI	41. D.O.B.	42. ADDRESS	43. TELEPHONE

Kathy was doing the Crime Stoppers update for the quarterly report and found this Complaint had slipped through without followup. Check the computer to see if contact was made at the time the original complaint came in. If not, would you followup? M.J. Bushman

PHN CALLS - (0640) 0638 HRS
LEFT MESSAGE FOR PARTY TO CALL BACK
COMPUTER FBI FILE - NEG
IN HOUSE SHOWS APLT. ADDRESS
INFO HAS NAME LISTED IN MENABHA
ALPHA CHECK SHOWS NO KEYS LISTED TO PARTY

110

501 11- 01100 P. 11/11, 11/00/10

4. INCIDENT *suspicious Vch 599-00242*

5. INCIDENT LOCATION *I-43 Nb Mtwc. River*

6. NAME- LAST-FIRST-MI [REDACTED] 31406 7. D.O.B. [REDACTED]

8. ADDRESS [REDACTED] 9. TX-HOME [REDACTED]

11. CITY [REDACTED] STATE ZIP 10. TX-BUSINESS [REDACTED]

12. DETAILS *reports Blazer Type vch in ditch*

11. 1037

12. 104

13. DAY

SUN 1 THU 5
 MON 2 FRI 6
 TUE 3 SAT 7
 WED 4

INCIDENT CARD

18. ASSIGNED *Novak 499*

19. REC. BY *493* 20. DIS. BY

21. HOW REC'D.
 1. 911
 2. POLICE RADIO
 3. PHONE
 4. TTY
 5. IN PERSON
 6. ON VIEW
 7. OFF. OFF DUTY
 8. C.B. RADIO
 9. OTHER

22. TYPE OF REPORT
 1. INCIDENT
 2. ACCIDENT
 3. CITATION
 4. NONE

23. STATUS
 1. UNFOUNDED
 2. PNL
 3. OTHER
 4. CLEARED
 5. EXCEPT CLEARED

24. DATE CLEARED *02/14/01*

25. OFFENSE TYPE
 1. ADULT NA
 2. JUVENILE
 3. UNKNOWN

21A. M.O.

ACTIVE

39. (CODE S-SUSPECT W-WITNESS V-VICTIM O-OTHER)				41. D.O.B.		42. ADDRESS		43. TELEPHONE	
CODE	40. NAME- LAST	FIRST	MI						

02/12/01 @ 1048 Hrs.: I, Deputy Novak, was sent to check on a vehicle parked in a ravine area on the east side of I-43, just south of CTH P. A caller to MTSO felt this vehicle may be connected to the HOCHSTETLER hit & run incident.

The vehicle in question clearly visible from I-43 has no front end damage and appears to be a junked vehicle parked at the rear of the property located at [REDACTED] CTH P. The vehicle is also a Dodge Ram which is not the suspect vehicle in the hit & run incident.

No further action taken. RANovak *[Signature]* /bjc

45. IF COMPLAINANT DIFFERENT THEN CALLER, ENTER NAME, ADDRESS, D.O.B., TELEPHONE.

46. IF CODE O (OTHER) IS USED IN FIELD #39, EXPLAIN.

INCIDENT REPORT: NOTE: IF SECTION 22 ABOVE HAS NUMBER 4 CHECKED, DO NOT GO BEYOND THIS LINE WITHOUT RECORDS SECTION BEING ADVISED, OR NO RECORD ENTRIES WILL BE MADE BELOW THIS LINE.

PROPERTY VALUE	26. PROPERTY	A. CURRENCY	B. JEWELRY	C. FURS CLOTHING	D. VEHICLE (LOCAL)	E. OFFICE EQUIPMENT	F. RADIO, TV CAMERAS	G. FIREARMS	H. HOUSEHOLD GOODS
	STOLEN	\$	\$	\$	\$	\$	\$	\$	\$
	RECOVERED	\$	\$	\$	\$	\$	\$	\$	\$
	26. PROPERTY	I. CONSUMABLES	J. LIVESTOCK	K. DRUGS	L. MARINE ITEMS	M. CONSTRUCTION ITEMS	N. LAWN AND GARDEN	O. SPORTING GOODS	P. MISC BICYCLE
	STOLEN	\$	\$	\$	\$	\$	\$	\$	\$
	RECOVERED	\$	\$	\$	\$	\$	\$	\$	\$

27. PROPERTY RECOVERED: LOCALLY _____ OTHER JURISDICTION _____ (INSERT O OR L)

PROPERTY ITEMIZATION	PROPERTY STOLEN/RECOVERED ITEMIZATION, USE THE FOLLOWING FORMAT				
	28. QUANTITY	29. ARTICLE NAME	30. BRAND NAME	31. SERIAL NUMBER	32. CODE
					S R <input type="checkbox"/> <input type="checkbox"/>
					S R <input type="checkbox"/> <input type="checkbox"/>
					S R <input type="checkbox"/> <input type="checkbox"/>
					S R <input type="checkbox"/> <input type="checkbox"/>
					S R <input type="checkbox"/> <input type="checkbox"/>

33. PROPERTY DAMAGE AMOUNT \$ _____ 34. INSURANCE COMPANY _____

35. OFFICER ASSAULTED Y N 36. ARSON Y N 37. STRUCTURE CODE _____ 38. DAMAGE \$ _____

47. CIB	ENTERED <input type="checkbox"/>	CANCELLED <input type="checkbox"/>	48. TOTAL AMOUNT PROPERTY STOLEN \$ _____
NCIC	<input type="checkbox"/>	<input type="checkbox"/>	
OTHER BROADCAST	<input type="checkbox"/>	<input type="checkbox"/>	
			49. TOTAL AMOUNT PROPERTY RECOVERED \$ _____

50. IS REPORT CONTINUED? YES NO 51. CAUTION INDICATORS, ATLS ETC.

52. DATA PROCESS INFORMATION:

COMPUTER ENTERED DATE 2/14/01

MICROFILM INDEXED INITIAL KS

IS CASE CLASSIFICATION CORRECT? N
IF N HAS CORRECTION BEEN MADE? N

53. FILE APPROVAL
BY JMZ DATE 2/14/01

SUPPLINE 00700 10.510.11 11.410.01

4. INCIDENT CS/S99-00242

5. INCIDENT LOCATION CTH CR

6. NAME-LAST [REDACTED] 7. D.O.B. [REDACTED]

8. ADDRESS [REDACTED] 9. TX-HOME [REDACTED]

10. TX-BUSINESS [REDACTED]

11. STATE [REDACTED]

12. DETAILS
Compl. who is Huber inmate reports
his mother [REDACTED]
who can be reached at [REDACTED] has
info re: suspect vehicle in fatal HR

7-12-01 0000

INCIDENT CARD

18. ASSIGNED
Sgt. Janssen 4114
MTSO 929
DET. SGT. LENK 294

19. REC. BY 957 20. DIS. BY

21. HOW REC'D.
 1. 911
 2. POLICE RADIO
 3. PHONE
 4. TTY
 5. IN PERSON
 6. ON VIEW
 7. OFF. OFF DUTY
 8. C.B. RADIO
 9. OTHER

22. TYPE OF REPORT
 1. INCIDENT
 2. ACCIDENT
 3. CITATION
 4. NONE

23. STATUS
 1. UNFOUNDED
 2. PNL
 3. OTHER
 4. CLEARED
 5. EXCEPT CLEARED

24. DATE CLEARED 09/06/01

25. OFFENSE TYPE
 1. ADULT NA
 2. JUVENILE
 3. UNKNOWN

21A. M.O.

ACTIVE

39. (CODE S-SUSPECT W-WITNESS V-VICTIM O-OTHER)	40. NAME-LAST	FIRST	MI	41. D.O.B.	42. ADDRESS	43. TELEPHONE
0	[REDACTED]	[REDACTED]	[REDACTED]	[REDACTED]	[REDACTED]	[REDACTED]
0	AHRENS	PETER	L	[REDACTED]	[REDACTED]	[REDACTED]

This information received from Corrections Officer William Stricklin while at Central Control at approx. 2230 on 7-11-01 when Huber inmate returned to jail. This information was relayed to Sgt. Janssen for follow up. LH 957

I, Det. Sgt. Lenk, spoke to [REDACTED] regarding information that she believed was vital to the hit & run homicide investigation of S99-00242. [REDACTED] stated she knows that PETER AHRENS [REDACTED] a 1985 GMC truck, blue and silver in color. She stated, in January 1999, PETER became a very strange-acting person which ultimately resulted in a [REDACTED]. [REDACTED] believes that since then, PETER had the 1985 GMC truck in his possession. She knows the truck at that time had over-sized tires and a snowplow on the front of it. [REDACTED] stated the grill was damaged, she believes, by the snowplow, according to PETER. [REDACTED] said the damage to the grill was in the lower left corner and was approximately 7" x 5-1/2" in size. [REDACTED] stated she knows the plow was on in December 1998 and that PETER kept the plow on for the entire winter months. [REDACTED] stated she also knows that the grill on the truck was painted a shiny, silver color with black in the areas that were not painted.

According to the description of the Evidence that was left at the crime scene, the information supplied by [REDACTED] on this vehicle does not match the vehicle Evidence which we currently have. This Crime Stopper report can be considered closed. JMLenk /bjc

45. IF COMPLAINANT DIFFERENT THEN CALLER, ENTER NAME, ADDRESS, D.O.B., TELEPHONE.

46. IF CODE O (OTHER) IS USED IN FIELD #39, EXPLAIN.

INCIDENT REPORT: NOTE: IF SECTION 22 ABOVE HAS NUMBER 4 CHECKED, DO NOT GO BEYOND THIS LINE WITHOUT RECORDS SECTION BEING ADVISED, OR NO RECORD ENTRIES WILL BE MADE BELOW THIS LINE.

PROPERTY VALUE	26. PROPERTY	A. CURRENCY	B. JEWELRY	C. FURS CLOTHING	D. VEHICLE (LOCAL)	E. OFFICE EQUIPMENT	F. RADIO, TV CAMERAS	G. FIREARMS	H. HOUSE-HOLD GOODS
	STOLEN	\$	\$	\$	\$	\$	\$	\$	\$
	RECOVERED	\$	\$	\$	\$	\$	\$	\$	\$
	26. PROPERTY	I. CONSUMABLES	J. LIVESTOCK	K. DRUGS	L. MARINE ITEMS	M. CONSTRUCTION ITEMS	N. LAWN AND GARDEN	O. SPORTING GOODS	P. MISC BICYCLE
	STOLEN	\$	\$	\$	\$	\$	\$	\$	\$
	RECOVERED	\$	\$	\$	\$	\$	\$	\$	\$

27. PROPERTY RECOVERED: LOCALLY _____ OTHER JURISDICTION _____ (INSERT O OR L)

PROPERTY ITEMIZATION	28. QUANTITY	29. ARTICLE NAME	30. BRAND NAME	31. SERIAL NUMBER	32. CODE	
					S	R
					<input type="checkbox"/>	<input type="checkbox"/>
					S	R
					<input type="checkbox"/>	<input type="checkbox"/>
					S	R
					<input type="checkbox"/>	<input type="checkbox"/>

33. PROPERTY DAMAGE AMOUNT \$ _____ 34. INSURANCE COMPANY _____

35. OFFICER ASSAULTED Y N 36. ARSON Y N 37. STRUCTURE CODE _____ 38. DAMAGE \$ _____

47. CIB	ENTERED <input type="checkbox"/>	CANCELLED <input type="checkbox"/>	48. TOTAL AMOUNT PROPERTY STOLEN \$ _____
NCIC	<input type="checkbox"/>	<input type="checkbox"/>	
OTHER BROADCAST	<input type="checkbox"/>	<input type="checkbox"/>	49. TOTAL AMOUNT PROPERTY RECOVERED \$ _____

50. IS REPORT CONTINUED? YES NO 51. CAUTION INDICATORS, ATLS ETC.

52. DATA PROCESS INFORMATION:

COMPUTER ENTERED DATE 19.13.01

MICROFILM INDEXED INITIAL KS

IS CASE CLASSIFICATION CORRECT? Y N

IF N HAS CORRECTION BEEN MADE? Y N

53. FILE APPROVAL

BY: [Signature] DATE 09.06.01

00111- 00110 0301 00000

4. INCIDENT: C/S (599-00242)

5. INCIDENT LOCATION:

6. NAME - LAST - FIRST - MI: ANON.

7. D.O.B.:

8. ADDRESS:

9. TX-HOME:

11. CITY STATE ZIP:

10. TX-BUSINESS:

12. DETAILS: INMATE @ MTSO STATED he believes Tim Christensen has a van that might be involved in 10-50 (Fatal) HTR.

June 30 2001

INCIDENT CARD

18. ASSIGNED: DET. Sgt. LENK 204

19. REC. BY: 204

20. DIS. BY: 204

21. HOW REC'D.:

- 1. 911
- 2. POLICE RADIO
- 3. PHONE
- 4. TTY
- 5. IN PERSON
- 6. ON VIEW
- 7. OFF. OFF DUTY
- 8. C.B. RADIO
- 9. OTHER

22. TYPE OF REPORT:

- 1. INCIDENT
- 2. ACCIDENT
- 3. CITATION
- 4. NONE

23. STATUS:

- 1. UNFOUNDED
- 2. PNL
- 3. OTHER
- 4. CLEARED
- 5. EXCEPT CLEARED

24. DATE CLEARED: 07/20/01

25. OFFENSE TYPE:

- 1. ADULT NA
- 2. JUVENILE
- 3. UNKNOWN

13. DAY:

SUN 1	THU 5
MON 2	FRI 6
TUE 3	SAT 7
WED 4	

39. (CODE S-SUSPECT W-WITNESS V-VICTIM O-OTHER)							
CODE	40. NAME - LAST	FIRST	MI	41. D.O.B.	42. ADDRESS	43. TELEPHONE	
0	CHRISTENSEN	TIMOTHY	D		S 20th St, Manitowoc		
0	MCCRACKEN	GREGORY	J		E River St, Two Rivers		

Information received from an anonymous source was that TIMOTHY CHRISTENSEN has a 1987 Chevy van with front end damage that he wants GREGORY MCCRACKEN to repair for him while he (CHRISTENSEN) is incarcerated at MTSO Jail. This van has been in storage for the last couple of years. CHRISTENSEN advised MCCRACKEN that he had the windshield replaced already but still needs the grill and front end repaired.

I, Det. Sgt. Lenk, checked the Jail records for January 1999 and found that CHRISTENSEN was not incarcerated during that time frame. In a record check for that time, it showed that CHRISTENSEN was the registered owner of a 1985 Chevy full-size van which at that time had WI RP TNM391, VIN [REDACTED].

I met with MCCRACKEN at an address of [REDACTED] 24th St, Two Rivers, to view the van which belonged to CHRISTENSEN. It was a mid-80s Chevy van with the entire front end replaced and no grill. The van was in poor condition. Several photos were taken of the van at this location. According to MCCRACKEN, CHRISTENSEN said he had some work done on this van at DRAMM COLLISION & REPAIR but that they did not finish the job.

This van was not the vehicle used in the hit & run fatal 10-50 due to the fact that the FBI Crime Lab has excluded vans from the list of possible vehicles. Also, the repairs done to this van would negate any possible evidence from this accident scene.

This Crime Stopper can be considered closed at this time. JMLenk /bjc

45. IF COMPLAINANT DIFFERENT THEN CALLER, ENTER NAME, ADDRESS, D.O.B., TELEPHONE.

46. IF CODE O (OTHER) IS USED IN FIELD #39, EXPLAIN.

INCIDENT REPORT: NOTE: IF SECTION 22 ABOVE HAS NUMBER 4 CHECKED, DO NOT GO BEYOND THIS LINE WITHOUT RECORDS SECTION BEING ADVISED, OR NO RECORD ENTRIES WILL BE MADE BELOW THIS LINE.

PROPERTY VALUE	26. PROPERTY	A. CURRENCY	B. JEWELRY	C. FURS CLOTHING	D. VEHICLE (LOCAL)	E. OFFICE EQUIPMENT	F. RADIO, TV CAMERAS	G. FIREARMS	H. HOUSE-HOLD GOODS
	STOLEN	\$	\$	\$	\$	\$	\$	\$	\$
	RECOVERED	\$	\$	\$	\$	\$	\$	\$	\$
	26. PROPERTY	I. CONSUM-ABLES	J. LIVESTOCK	K. DRUGS	L. MARINE ITEMS	M. CONSTRUCTION ITEMS	N. LAWN AND GARDEN	O. SPORTING GOODS	P. MISC BICYCLE
	STOLEN	\$	\$	\$	\$	\$	\$	\$	\$
	RECOVERED	\$	\$	\$	\$	\$	\$	\$	\$

27. PROPERTY RECOVERED: LOCALLY _____ OTHER JURISDICTION _____ (INSERT O OR L)

PROPERTY ITEMIZATION	PROPERTY STOLEN/RECOVERED ITEMIZATION, USE THE FOLLOWING FORMAT				
	28. QUANTITY	29. ARTICLE NAME	30. BRAND NAME	31. SERIAL NUMBER	32. CODE
					S R <input type="checkbox"/> <input type="checkbox"/>
					S R <input type="checkbox"/> <input type="checkbox"/>
					S R <input type="checkbox"/> <input type="checkbox"/>
					S R <input type="checkbox"/> <input type="checkbox"/>

33. PROPERTY DAMAGE AMOUNT \$ _____

34. INSURANCE COMPANY _____

35. OFFICER ASSAULTED Y N

36. ARSON Y N

37. STRUCTURE CODE _____

38. DAMAGE \$ _____

47. CIB	ENTERED <input type="checkbox"/>	CANCELLED <input type="checkbox"/>
NCIC	<input type="checkbox"/>	<input type="checkbox"/>
OTHER BROADCAST	<input type="checkbox"/>	<input type="checkbox"/>

48. TOTAL AMOUNT PROPERTY STOLEN \$ _____

49. TOTAL AMOUNT PROPERTY RECOVERED \$ _____

50. IS REPORT CONTINUED? YES NO

51. CAUTION INDICATORS, ATLS ETC.

52. DATA PROCESS INFORMATION:

COMPUTER ENTERED DATE 07 02 01

MICROFILM INDEXED INITIAL bju

IS CASE CLASSIFICATION CORRECT? Y N
IF N HAS CORRECTION BEEN MADE? Y N

53. FILE APPROVAL

BY WRB DATE 07 20 01

S01 N# 08131 163101 1141011

4. INCIDENT CS S99-00242

5. INCIDENT LOCATION CTH CR

6. NAME-LAST-FIRST-MI ANNA 7. D.O.B.

8. ADDR

9. TX-HOME

10. TX-BUSINESS

11. CITY STATE ZIP

12. DETAILS INFO ON CASE

100101 1031 1031

14. REC'D 15. DISP 16. 10-23 17. 10-24

13. DAY
 SUN 1 THU 5
 MON 2 FRI 6
 TUE 3 SAT 7
 WED 4

INCIDENT CARD

18. ASSIGNED Schetter 493
 MTSO 929
 Michel 284

19. REC. BY 923 20. DIS. BY

21. HOW REC'D.
 1. 911
 2. POLICE RADIO
 3. PHONE
 4. TTY
 5. IN PERSON
 6. ON VIEW
 7. OFF. OFF DUTY
 8. C.B. RADIO
 9. OTHER

22. TYPE OF REPORT
 INCIDENT
 ACCIDENT
 CITATION
 NONE

23. STATUS
 1. UNFOUNDED
 2. PNL
 3. OTHER
 4. CLEARED
 5. EXCEPT CLEARED

24. DATE CLEARED 10/26/01

25. OFFENSE TYPE
 1. ADULT NA
 2. JUVENILE
 3. UNKNOWN

39. (CODE S-SUSPECT W-WITNESS V-VICTIM O-OTHER)				41. D.O.B.		42. ADDRESS		43. TELEPHONE	
CODE	40. NAME-LAST	FIRST	MI						
0	VERTZ	RONALD SR	W. B. 1945	[REDACTED]		CTH K, Whitelaw			

10-01-01 @ 1031 hrs.: I, Lt. Schetter, was notified by dispatch that a party was providing information ref. Crime Stopper # S99-00242 (HOCKSTETLER death investigation.) The dispatcher indicated that the female party appears to have some information and is turning over to the shift commander to provide any possible further information. The caller did indicate that she would identify herself, but wants to remain strictly anonymous and would only want her information available to investigators if in fact they need to call her back for further information. With this, I received the following identification of the caller as [REDACTED] address [REDACTED], phone [REDACTED], cell phone [REDACTED]

Crime Stopper provided the following information. They believe that a person that should be looked at is identified as a RON VERTZ whose family lives on CTH K and is considered somewhat secluded or very quiet. Caller stated that she is familiar with RON VERTZ, as she used to work in a local restaurant with a friend and met him on occasion. At or about the time of the HOCKSTETLER death, the caller indicated that she knew RON VERTZ had drove around in a Chevy Suburban type vehicle. She stated that she also noted that approx. two months ago, there are two vehicles sitting in the yard and the third one is no longer there. Several months ago, they also ran into RON VERTZ and asked him what had happened to his third Chevy Suburban in which he indicated that he had transmission problems with it and was working on getting it fixed. This struck her somewhat suspiciously, as there was two other Suburban in the driveway that could be used for parts and the fact that the Suburban had come up missing shortly after the HOCKSTETLER incident.

The caller also indicated that RON VERTZ would brag on several occasions that he would get highly intoxicated or drunk and then would drive on "no name roads" throughout the night until he sobered up on several different occasions.

The caller then indicated that she wants the Sheriff's Dept. to be aware of this information, as she continues to think about the information she provided that RON VERTZ may be the suspect in this matter and due to the fact that the family does not have a lot of social ties or friends that it would be easy for the information to be kept more secret. I informed the caller that this information will be passed onto an investigator and that if

1083-PP2 20
 RD HTD

45. IF COMPLAINANT DIFFERENT THEN CALLER, ENTER NAME, ADDRESS, D.O.B., TELEPHONE.

46. IF CODE O (OTHER) IS USED IN FIELD #39, EXPLAIN.

INCIDENT REPORT: NOTE: IF SECTION 22 ABOVE HAS NUMBER 4 CHECKED, DO NOT GO BEYOND THIS LINE WITHOUT RECORDS SECTION BEING ADVISED, OR NO RECORD ENTRIES WILL BE MADE BELOW THIS LINE.

PROPERTY VALUE	26. PROPERTY	A. CURRENCY	B. JEWELRY	C. FURS CLOTHING	D. VEHICLE (LOCAL)	E. OFFICE EQUIPMENT	F. RADIO, TV CAMERAS	G. FIREARMS	H. HOUSE-HOLD GOODS
	STOLEN	\$	\$	\$	\$	\$	\$	\$	\$
	RECOVERED	\$	\$	\$	\$	\$	\$	\$	\$
	26. PROPERTY	I. CONSUM-ABLES	J. LIVESTOCK	K. DRUGS	L. MARINE ITEMS	M. CONSTRUCTION ITEMS	N. LAWN AND GARDEN	O. SPORTING GOODS	P. MISC BICYCLE
STOLEN	\$	\$	\$	\$	\$	\$	\$	\$	
RECOVERED	\$	\$	\$	\$	\$	\$	\$	\$	

27. PROPERTY RECOVERED: LOCALLY _____ OTHER JURISDICTION _____ (INSERT O OR L)

PROPERTY ITEMIZATION	PROPERTY STOLEN/RECOVERED ITEMIZATION, USE THE FOLLOWING FORMAT				
	28. QUANTITY	29. ARTICLE NAME	30. BRAND NAME	31. SERIAL NUMBER	32. CODE
					S R <input type="checkbox"/> <input type="checkbox"/>
					S R <input type="checkbox"/> <input type="checkbox"/>
					S R <input type="checkbox"/> <input type="checkbox"/>
					S R <input type="checkbox"/> <input type="checkbox"/>
					S R <input type="checkbox"/> <input type="checkbox"/>

33. PROPERTY DAMAGE AMOUNT \$ _____ 34. INSURANCE COMPANY _____

35. OFFICER ASSAULTED Y N 36. ARSON Y N 37. STRUCTURE CODE _____ 38. DAMAGE \$ _____

47. CIB	ENTERED <input type="checkbox"/>	CANCELLED <input type="checkbox"/>	48. TOTAL AMOUNT PROPERTY STOLEN \$ _____
NCIC	<input type="checkbox"/>	<input type="checkbox"/>	
OTHER BROADCAST	<input type="checkbox"/>	<input type="checkbox"/>	
			49. TOTAL AMOUNT PROPERTY RECOVERED \$ _____

50. IS REPORT CONTINUED? YES NO 51. CAUTION INDICATORS, ATLS ETC.

52. DATA PROCESS INFORMATION:

COMPUTER ENTERED DATE 12/29/01

MICROFILM INDEXED INITIAL RS

IS CASE CLASSIFICATION CORRECT? Y N

IF N HAS CORRECTION BEEN MADE? Y N

53. FILE APPROVAL

BY WES DATE 12/29/01

MANITOWOC COUNTY SHERIFF'S DEPARTMENT
FOLLOW-UP REPORT

Page: 2

CASE NUMBER: S01-08131 CLASSIFICATION: _____

INCIDENT: _____

DATE AND TIME: _____

REPORT CONTINUED:

further information is requested that they would be in contact with her. She also indicated that she would be checking back on the case and was provided with the above incident # and also believed that she is interested in the Crime Stoppers reward. Lt. GSchetter/
klf

10/03/01 Complaint forwarded to SGT.LENK, who assigned Det. Michel. Det. Michel and I discussed the incident and I agreed to accompany him to view the suspect vehicles when he makes contact. MJBushman

12/18/01: I, Det. Michel, along with D.I. M. Bushman went to the VERTZ residence located at [REDACTED] CTH K, Whitelaw, where we met with RONALD VERTZ, SR. Upon entering the yard, the 2 Suburbans mentioned in this report were observed parked amongst numerous other vehicles. Both Suburbans were facing the road and readily identified as not matching the grill description of the suspect vehicle.

In questioning VERTZ on the possession of Suburbans over the past 2 years, he identified the 2 currently at his residence and a third which he stated was not mechanically road-legal and had been transferred to use at a farm in northern WI. VERTZ stated this vehicle had been in inventory in his yard but had not been used due to its condition. VERTZ also stated that none of his vehicles received any front end damage, and he recalled having been checked near the time of the incident we were investigating by TRPD officers.

VERTZ was very cooperative and did allow us to look around the property as he has 10-20 vehicles in various conditions parked around the buildings. Most of these vehicles were Chevrolet products and appeared not to be operable. The vehicles of interest which were checked were: 1 Suburban bearing WI RP PCH319, expiring 2000; a second Suburban bearing WI RP HSM175, expiring 1993; a pickup truck bearing WI RP BE49539, expiring 1995; and 2 vans-- one a brown GMC, the second a white Chevrolet, each bearing no RPs. None of these vehicles displayed any indication that they were the suspect vehicle.

Through inspection of the vehicles located on the VERTZ residence and interview with VERTZ, it was concluded that the vehicles are not suspected in the investigation of incident S99-00242. There is no further follow-up intended reference this Crime Stoppers report.

JMMichel /bjc

501 17- 00710 43101 1051000

4. INCIDENT
@ RIMESTOPPER / S99-00242

5. INCIDENT LOCATION

6. NAME - LAST - FIRST - MI
ANON

7. D.O.B.

8. ADDRESS

9. TX-HOME

11. CITY STATE ZIP

10. TX-BUSINESS

12. DETAILS
Rec'd info of possible
veh. involved in H&R
incident.

INCIDENT CARD

18. ASSIGNED
GLAESER 4117

19. REC. BY
922

20. DIS. BY
N/A

22. TYPE OF REPORT
 INCIDENT
 ACCIDENT
 CITATION
 NONE

23. STATUS
 UNFOUNDED
 PNL
 OTHER
 CLEARED
 EXCEPT CLEARED

24. DATE CLEARED
10/17/01

25. OFFENSE TYPE
 1. ADULT
 2. JUVENILE
 3. UNKNOWN
 NA

21. HOW REC'D.
 1. 911
 2. POLICE RADIO
 3. PHONE
 4. TTY
 5. IN PERSON
 6. ON VIEW
 7. OFF. OFF DUTY
 8. C.B. RADIO
 9. OTHER

21A. M.O.

13. DAY
 SUN 1 THU 5
 MON 2 FRI 6
 TUE 3 SAT 7
 WED 4

14. REC'D
15. DISP
16. 10-23
17. 10-24

39. (CODE S-SUSPECT W-WITNESS V-VICTIM O-OTHER)

CODE	40. NAME-LAST	FIRST	MI	41. D.O.B.	42. ADDRESS	43. TELEPHONE
0	[REDACTED]	[REDACTED]	[REDACTED]	[REDACTED]	[REDACTED]	[REDACTED]
0	[REDACTED]	[REDACTED]	[REDACTED]	[REDACTED]	[REDACTED]	[REDACTED]

10/10/01 @ 0900 Hrs.: I, Deputy E. Glaeser, was given information referred to me by D.I. M. Bushman in regard to follow-up on a possible Crime Stopper complaint for incident S99-00242. The information was that a female TRPD officer had taken a complaint on a different matter from [REDACTED] while at TRPD. While this officer was speaking with [REDACTED], he noticed the reward poster for information in regard to the HOCHSTETLER case. Apparently, [REDACTED] relayed information that his father, [REDACTED] had several vehicles that matched the description of the suspect vehicle. Specific information was relayed to the TRPD officer that one vehicle in particular was repaired by [REDACTED] specifically the grill area, front bumper, and bug deflector.

Note: I checked the in-house FBI computer program on both [REDACTED] and [REDACTED]. I noted there were no entries for either one of these parties on vehicles that had been checked in regard to our original incident.

An attempt will be made to contact [REDACTED] in regard to the specifics of this information. Due to the fact I had other calls and follow-up work to do, I will complete follow-up of this particular case upon my return to work on 10/13/01.

10/13/01 @ 0800 Hrs.: I attempted telephone contact with [REDACTED] but met with negative results.

10/13/01 @ 0815 Hrs.: I attempted contact at the [REDACTED] residence on [REDACTED], but met with negative results.

10/14/01 @ 1015 Hrs.: I attempted telephone contact with [REDACTED] but met with negative results.

10/14/01 @ 1045 Hrs.: I attempted contact with [REDACTED] at his residence but met with negative results.

I will continue to attempt to contact [REDACTED]. It should be noted that on the attempts made on 10/13/01 and 10/14/01, I left my business card at the residence with a request on the

45. IF COMPLAINANT DIFFERENT THEN CALLER, ENTER NAME, ADDRESS, D.O.B., TELEPHONE.

46. IF CODE O (OTHER) IS USED IN FIELD #39, EXPLAIN.

INCIDENT REPORT: NOTE: IF SECTION 22 ABOVE HAS NUMBER 4 CHECKED, DO NOT GO BEYOND THIS LINE WITHOUT RECORDS SECTION BEING ADVISED, OR NO RECORD ENTRIES WILL BE MADE BELOW THIS LINE.

PROPERTY VALUE	26. PROPERTY	A. CURRENCY	B. JEWELRY	C. FURS CLOTHING	D. VEHICLE (LOCAL)	E. OFFICE EQUIPMENT	F. RADIO, TV CAMERAS	G. FIREARMS	H. HOUSE-HOLD GOODS
	STOLEN	\$	\$	\$	\$	\$	\$	\$	\$
	RECOVERED	\$	\$	\$	\$	\$	\$	\$	\$
	26. PROPERTY	I. CONSUMABLES	J. LIVESTOCK	K. DRUGS	L. MARINE ITEMS	M. CONSTRUCTION ITEMS	N. LAWN AND GARDEN	O. SPORTING GOODS	P. MISC BICYCLE
	STOLEN	\$	\$	\$	\$	\$	\$	\$	\$
	RECOVERED	\$	\$	\$	\$	\$	\$	\$	\$

27. PROPERTY RECOVERED: LOCALLY _____ OTHER JURISDICTION _____ (INSERT O OR L)

PROPERTY ITEMIZATION	PROPERTY STOLEN/RECOVERED ITEMIZATION, USE THE FOLLOWING FORMAT				
	28. QUANTITY	29. ARTICLE NAME	30. BRAND NAME	31. SERIAL NUMBER	32. CODE
					S <input type="checkbox"/>
					R <input type="checkbox"/>
					S <input type="checkbox"/>
					R <input type="checkbox"/>

33. PROPERTY DAMAGE AMOUNT \$ _____

34. INSURANCE COMPANY _____

35. OFFICER ASSAULTED Y N

36. ARSON Y N

37. STRUCTURE CODE _____ 38. DAMAGE \$ _____

47. CIB ENTERED CANCELLED
 NCIC
 OTHER BROADCAST

48. TOTAL AMOUNT PROPERTY STOLEN \$ _____

49. TOTAL AMOUNT PROPERTY RECOVERED \$ _____

50. IS REPORT CONTINUED? YES NO

51. CAUTION INDICATORS, ATLS ETC.

52. DATA PROCESS INFORMATION:

COMPUTER ENTERED DATE 10/17/01

MICROFILM INDEXED INITIAL *by*

IS CASE CLASSIFICATION CORRECT? Y N
 IF N HAS CORRECTION BEEN MADE? Y N

53. FILE APPROVAL

BY *[Signature]* DATE 10/17/01

MANITOWOC COUNTY SHERIFF'S DEPARTMENT
FOLLOW-UP REPORT

Page: 2

CASE NUMBER: 501-08413 CLASSIFICATION: _____

INCIDENT: _____

DATE AND TIME: _____

REPORT CONTINUED:

back that [REDACTED] contact me at MTSO.

10/15/01 @ 0500 Hrs.: I, Deputy Glaeser, received a telephone call from [REDACTED] and arrangements were made for me to speak with him at his residence at 0600 hours today.

10/15/01 @ 0600 Hrs.: I spoke to [REDACTED] at his residence in regard to this incident. Upon my first contact with [REDACTED] he was observed to be standing at the top of the staircase at his residence. He motioned for me to come into the residence. Upon entering the residence, I noted the heat was extremely intense in his apartment, and I estimated the temperature to be approximately 80 degrees. The subject identified himself as [REDACTED] and he told me that I would have to speak loudly because he was deaf and that his hearing aids did not work too good.

I entered [REDACTED]'S residence where he asked me to be seated in the living room. When I asked [REDACTED] if he knew why I was there to talk to him, he explained to me that he was "pissed off at [REDACTED] for not putting a new boiler in the residence. He stated his heat costs have been outrageous for the last year. He indicated that he was "pissed off" at his [REDACTED] for not purchasing a new boiler for the building. [REDACTED] told me, "I'm deaf, just about blind, and fucking crazy." [REDACTED] went on to tell me that he believes his father is "as crazy as he is."

When I asked [REDACTED] if he knew the reason I was there to speak to him, he indicated it had to do with the hit & run and the HOCHSTETLER case. I asked [REDACTED] if it was true that he spoke to a TRPD officer in regard to the information on the hit & run. He indicated he spoke to Officer Peters and that he did relay information to her in regard to possibly suspecting his father as being the driver of the hit & run vehicle. [REDACTED] told me he "just wishes he had some solid evidence" that would indicate who might be possibly involved in the incident.

I asked [REDACTED] if it was true that he told the TRPD officer that one of his father's vehicle had sustained damage consistent with the hit & run. He told me that the more he thought about it, the more he believes his father is "just crazy." In speaking specifically in regard to evidence linking his father to this possible suspect vehicle, [REDACTED] told me the truth of the matter was that his father is a rather odd individual and he has been known to paint his whole 27' boat by hand with a paint brush.

The truth of the matter in regard to damage to his father's Suburban was that [REDACTED] thought it was quite odd that his father [REDACTED] took a bug deflector off the vehicle because it had a chip in it or because one corner of it was broken. [REDACTED] stated he noted his father used a paint brush and touched up some paint on the bumper. [REDACTED] told me the truth of it was he really had no evidence implicating his father may have been the operator of the hit & run vehicle in this particular case.

[REDACTED] did, however, tell me that he had been thinking about the incident recently and his concern was that his father, [REDACTED] was a bad alcoholic who had 5-6 drunk driving convictions on his record. He indicated that his father also had a tendency to register

MANITOWOC COUNTY SHERIFF'S DEPARTMENT
FOLLOW-UP REPORT

Page: 3

CASE NUMBER: 50-08413 CLASSIFICATION: _____

INCIDENT: _____

DATE AND TIME: _____

REPORT CONTINUED:

vehicles in his, [REDACTED], name. [REDACTED] told me he was quite worried that through the police investigation, officers may find a vehicle that was operated by his father at the time of the hit & run but would have been registered to himself ([REDACTED]). [REDACTED] also told me that he knows his father, [REDACTED] has a Warrant out of SHSO for OWI. [REDACTED] told me that he has been trying to talk his father into coming back to WI to face up to his mistakes that he has made in the past and possibly enter an alcohol treatment facility.

I, Deputy Glaeser, asked [REDACTED] if he had any information that was pertinent to the hit & run investigation. He told me, at this time, he did not have any solid evidence or, for that matter, any evidence at all.

No further action taken. EJGlaeser *EJG* /bjc

TWO RIVERS POLICE CARE

Police Department

Two Rivers WI 54241-0087

EMERGENCY DIAL 911

Non-Emergency Police Response [REDACTED]

Police Business Office [REDACTED]

Mon.-Fri. 7:00 a.m. to 4:30 p.m.

Fax [REDACTED]

email [REDACTED]



FAX COVER SHEET

TO: Deputy Inspector Bushman

FROM: Two Rivers Police Department

SUBJECT: Suburban

DATE: 10-09-01

DESTINATION FAX NUMBER: [REDACTED]

NUMBER OF PAGES SENT (INCLUDING THIS COVER): 2

SPECIAL NOTES AND/OR COMMENTS:

This message is intended only for the use of the individual or entity to which it is addressed and may contain information that is privileged, confidential, and exempt from disclosure under applicable law. If the reader of this message is not the intended recipient or the employee or agent responsible for delivering the message to the intended recipient, you are hereby notified that any dissemination, distribution, or copying of this communication is strictly prohibited. If you have received this communication in error, please notify us immediately by telephone and return the original message to us at the above address via the U.S. Postal Service. Thank you.

INCIDENT TYPE: **Dept Info**
 INCIDENT LOCATION: **2300 ST.**
 NAME (last, first, middle): **[REDACTED]**
 ADDRESS: **[REDACTED]**
 CITY: **TWO RIVERS** STATE: **WI** ZIP: **54241**
 HOME TELEPHONE: **[REDACTED]**
 WORK TELEPHONE: **[REDACTED]**

REC'D 10-9-01
 DISP 10-23
 10-24
 1404
 1404
 1411
 1510

OFFICERS ASSIGNED:
Peters 87A

NARRATIVE:
Comp came to the PD to speak with an officer
MTSO COM # 501-08413

REC. BY	DIS. BY	TYPE/REPORT
956	956	1. ACCIDENT 2. OFFICER 3. NARRATIVE 4. CASE 5. ARREST 6. CITATION 7. INCIDENT
HOW RECEIVED		STATUS
ALM	ALARM	AC ACTIVE
SCN	AT THE SCENE	CA CLEARED/ARREST
CB	CB RADIO	CL CLOSED
DIS	DISPATCH	CO COMMENT
FAX	FAX	EMER DETEN
FOP	FOUND/PATROL	DA DETENTION/ALCOHOL
DSK	FRONT DESK	EC EX CLEAR
PER	IN PERSON	IN INACTIVE
MAIL	MAIL	OT OTHER
OFF	OFFICER/OFF DUTY	UL UNABLE/LOG
OTH	OTHER	UN UNFOUNDED
OTH	OTHER AGENCY	
RAD	RADIO	
TDD	TELEPHONE/DEAF	
TEL	TELEPHONE	
TTY	TELETYPE	
911	911 TELEPHONE	

IF COMPLAINANT DIFFERENT THEN CALLER, ENTER NAME, ADDRESS, D.O.B., TELEPHONE

T.I.M.E. SYSTEM ENTRY

	ENTERED	DATE	TIME	INITIALS	CANCELED	DATE	TIME	INITIALS
CIB	<input type="checkbox"/>				<input type="checkbox"/>			
NCIC	<input type="checkbox"/>				<input type="checkbox"/>			
OTHER BROADCAST	<input type="checkbox"/>				<input type="checkbox"/>			

ALL SHADED AREAS TO BE COMPLETED BY TWO RIVERS POLICE DEPARTMENT EMPLOYEES
 TWO RIVERS POLICE DEPARTMENT EMPLOYEES TO COMPLETE INFORMATION BELOW

INVESTIGATIVE PROCESSING INFORMATION:

EVIDENCE COLLECTED PROPERTY COLLECTED PHOTOGRAPHS TAKEN VIDEOS TAKEN STATEMENTS COMPLETED

NON-CONSENT FORM COMPLETED FINGERPRINTS LIFTED SUSPECT FINGERPRINTS TAKEN

ASSIGNMENTS:

OFFICER	TASK	DATE ASSIGNED	DATE DUE
#1.			
#2.			
#3.			
#4.			

INCIDENT # **95125**

CASE DISPOSITION: **mm** DATE COMPLETED: **10-09-01**

ARREST COMPLETED INACTIVE ACTIVE UNFOUNDED

Incident # 01-95125
Officer YJP
Supervisor AKK

Page 1

10-09-01 1404 hours

On the above date and time, I, Officer Peters, responded to the Police Department to speak with an individual who requested to speak to an officer. Upon arrival, I spoke with complainant, [REDACTED]. I escorted [REDACTED] into an interview room and asked him what the problem was today. [REDACTED] replied that the problem was booze. [REDACTED] stated that his father, [REDACTED], has a problem with alcohol and needs to be helped. [REDACTED] stated that his father, [REDACTED] has a warrant in Shawano County for OWI and is hiding out in Florida using a fake ID. [REDACTED] also stated that his father owes taxes, and [REDACTED] afraid that he will be kicked out of the place he is living, due to outstanding bills.

[REDACTED] then informed me that he may have information regarding a hit and run that happened approximately 2 ½ years ago. [REDACTED] indicated that approximately 2 ½ years ago [REDACTED] had owned 3 Suburbans. [REDACTED] recalled waking up in the middle of the night and observing his father replacing one of the grills in the Suburban. [REDACTED] also saw [REDACTED] repainting parts of the Suburban near the bumper on the passenger side, and also noticed that a part of the bug deflector was broken. [REDACTED] stated that the Suburban was either cream or light tan in color and the bug deflector was either smoke colored or red. [REDACTED] stated that it is possible that his father [REDACTED] may have been involved in this accident.

I did make contact with Deputy Inspector Bushman of Manitowoc County Sheriff's Dept. I informed Bushman of the information regarding the Suburban information I had received.

It should be noted that [REDACTED] is very hard of hearing, and also appeared to be somewhat mentally unstable.

Peters 874 10-12-01 1725 hours Jacquart 10-15-01 1015 hours

MANITOWOC COUNTY SHERIFF'S DEPARTMENT
FOLLOW-UP REPORT

Page: 2

CASE NUMBER: 502-00851 CLASSIFICATION: _____

INCIDENT: _____

DATE AND TIME: _____

REPORT CONTINUED:

O MARQUARDT ¹⁴¹²²⁰⁶ MANNON M [REDACTED] [REDACTED] N Maribel Rd, Maribel [REDACTED]
V HOCHSTETLER ¹⁴¹²²⁰⁶ RICHARD D 05/13/81

01/10/02: I, Deputy A. Colborn, received contact from an MTSO employee who resides in the Village of Maribel who informed me that he observed a full-size Chevy pickup truck bearing WI RP 494508 in Maribel. This individual also informed me that the truck, in December, had a missing front grill, a large dent in the front bumper, and another dent on the right front fender. This individual now informs me that the vehicle has since been repaired. The individual told me that he first noticed the damage to the truck around the end of November 2001 and that the truck was damaged at least until the end of December 2001. This individual informed me that the next time he observed the truck, the damage was repaired, somewhere around the first week of January 2002.

A check of the RP (494508) revealed that it is assigned on a 1987 Chevy pickup truck belonging to MANNON MARQUARDT of [REDACTED] N Maribel Rd, Maribel. This would be the residence where the complainant informed me that he observed the truck parked.

02/02/02: I was finally able to make contact with the owner of the vehicle, that being MANNON MARQUARDT. I further observed the 1987 Chevy pickup truck which was dark blue in color parked in the driveway. I observed the vehicle to not have any front end damage whatsoever. I observed a small dent in the right front fender. Looking under the vehicle, I did not observe any type of biological evidence. I further observed the truck to be a 4-wheel drive vehicle.

Contact was made with MARQUARDT who identified himself as the owner of the vehicle. MARQUARDT stated he has owned the vehicle for approximately 2 years and when he purchased the vehicle, there was no front end damage. MARQUARDT stated, in November 2001, he struck a deer. MARQUARDT stated there should be an accident report on file with MTSO, although he could not recall the name of the officer who handled the car-deer accident. MARQUARDT further stated that he purchased the grill and front bumper from TISLER'S AUTO SALVAGE. MARQUARDT stated he repaired the vehicle himself at his garage.

A check of MARQUARDT through MTSO in-house did reveal that on 11/11/01 at 0535 hours, he reported a car-deer accident to Deputy O'Connor who did complete a non-reportable WI driver report of accident (see attached). On the accident form, the front of the vehicle is circled, indicating that the damage occurred to the front of the MARQUARDT vehicle.

At this time, the damage to the MARQUARDT vehicle does appear to be consistent with the damage listed on the driver report of accident by Deputy O'Connor. It does not appear that the MARQUARDT vehicle is involved in incident S99-00242. No further action taken at this time. A copy of this incident should be forwarded to Det. Sgt. Lenk upon completion of typing. ✓ALColborn /bjc

030300

INCIDENT HISTORY DETAIL: X020110434

INITIATE: 21:57:38	01/11/02	CALL NUMBER:	X0434
ENTRY: 21:58:27		CURRENT STATUS:	CLOSED
DISPATCH:		PRIMARY UNIT:	
ONSCENE:		CASE NUMBER:	SO0200000259
CLOSE: 21:58:27		DISPOSITION:	

LOCATION: HY CR			
LOCATION COMMENTS:			
DAREA: MTSO		GEO OVERRIDE	
BEAT: UNK	TYPE: CS	S99-00242	
RD:	PRIORITY: 5		

21:58:27 DW04 ENTRY	TEXT:SEE ATTACHED CS FORM. \COMP:ANONYMOUS
21:58:27 DW04 CLOSE	CLOSED EVENT ENTERED
21:58:56 DW04 CASE	SO0200000259 Assigned

OPERATOR ASSIGNMENTS: DW04 D935 STECKMESSER, LYNN

MANITOWOC COUNTY SHERIFF'S DEPARTMENT
FOLLOW-UP REPORT

Page: 2

CASE NUMBER: 502-00259 CLASSIFICATION: _____

INCIDENT: _____

DATE AND TIME: _____

REPORT CONTINUED: _____

V HOCHSTETLER RICHARD ^{7/14/8034} D 05/13/81

01/31/02: I, D.I. M. Bushman, received this Crime Stoppers Interview Form and complaint. The caller is anonymous and did not give a call-back number. The caller believes that AL and JOANN HOLTZ may know something about the accident because they did not feel any remorse after hearing about the accident. I do not believe that this information is valid enough to go and question AL and JOANN about this hit & run accident. The caller advised, at the time this complaint was filed, they would call back on Monday in the p.m.; however, that call never came. It is now approximately 1 month since this complaint has been filed and we still have not received a call-back validating any information that would be suspicious.

This report can be closed out for now. MJBushman ^{HTB} /bjc

INCIDENT HISTORY DETAIL: X020110159

1-15-02
RP

INITIATE: 11:04:18 01/11/02 CALL NUMBER: X0159
ENTRY: 11:07:31 CURRENT STATUS: CLOSED
DISPATCH: PRIMARY UNIT:
ONSCEN: CASE NUMBER: SO0200000226
CLOSE: 11:07:31 DISPOSITION:

W
C
A

LOCATION: SILVER CREEK RD N/CR ,MTW (SILVER CREEK/CR)

LOCATION COMMENTS:

DAREA: MTSO
BEAT: S03 MAP PAGE: FIE TYPE: CS CRIME STOPPER
RD: 14012 PRIORITY: 5

11:07:31 DW01 ENTRY TEXT:1 MO. AGO COMPL NOTICED A CHEV PU WITH GRILL
KNOCKED OUT BROWNISH IN COLOR NO PLATES BUMPER HAS
DENT IN IT BROKE OUT UPPER RIGHT HEAD LIGHT AND PIECE
MISSING LOWER LEFT. IS WILLING TO SPEAK TO AN OFFICER
COMP:LAVERN (JACK) F GASSER 101833 \LOC: [REDACTED] CTH G
CRIVITZ \PH: [REDACTED]
11:07:31 DW01 CASE SO0200000226 493
11:07:31 DW01 CLOSE CLOSED EVENT ENTERED

OPERATOR ASSIGNMENTS: DW01 D923 KLOSTERMAN, LORI

MANITOWOC COUNTY SHERIFF'S DEPARTMENT
FOLLOW-UP REPORT

Page: 2

CASE NUMBER: 502-00226 CLASSIFICATION: _____

INCIDENT: _____

DATE AND TIME: _____

REPORT CONTINUED:

W GASSER LAVERNE (aka JACK) F [REDACTED] [REDACTED] CTH G, Crivitz [REDACTED]
V HOCHSTETLER RICHARD D 05/13/81

01/11/02 @ 1107 Hrs.: I, Lt. Schetter, was notified by Dispatch that a person was on the telephone, reporting information reference Crime Stoppers and the HOCHSTETLER hit & run fatal accident. With this, a phone call was placed through the Shift Commanders' Office to obtain further information.

I spoke with a male party who identified himself as LAVERNE (aka JACK) GASSER who resides on CTH G in Crivitz, WI. GASSER indicated that he observed a brownish Chevy pickup truck approximately 1 month ago in Marinette Co. that jogged his memory about the fatal accident which occurred in Manitowoc Co. GASSER further indicated that on yesterday's date, he observed a story on one of the local news stations, indicating that MTSO still has not located the suspect vehicle regarding this matter and provided a phone number. With this, GASSER once again checked the area where he last noted the Chevy pickup truck and confirmed that it was still at the location in Marinette Co. and wishes to notify MTSO of this possible vehicle.

GASSER also indicated that this vehicle is located approximately 20-25 miles east of Crivitz and that it is an older model Chevy pickup truck with damage to the front bumper, the grill is broken out in the upper right headlight area, and a piece of grill is missing in the lower left corner area. There also is no front RP attached to this pickup truck, and it appears to be parked on private property next to a lean-to.

GASSER further indicated that he would be willing to meet with an officer to take him to the vehicle in question so that they can inspect it further to see if it would be related to this criminal matter.

I made contact with MRSO and spoke to Sgt. Evancheck. I requested their assistance regarding this matter. Sgt. Evancheck indicated that they would assign an officer to meet up with GASSER, inspect the vehicle, take photos, and forward the photos to our dept. to see if further investigation is warranted. With this, I typed up a request and faxed it to MRSO, pursuant to the above information (see attached).

I request that the findings and any further information be forwarded to D.I. M. Bushman who is considered the lead investigator reference this matter. GJSchetter /bjc

01/28/02: I, D.I. M. Bushman, received a packet of information from MRSO Deputy Sgt. Matthew D. Evancheck. Sgt. Evancheck made contact with the witness in this complaint and was escorted to the suspect vehicle. There are 8 photos of a 1/2-ton red custom 1985-1988 Chevy pickup with MI RP 1469GQ, no expiration sticker is visible.

MANITOWOC COUNTY SHERIFF'S DEPARTMENT
FOLLOW-UP REPORT

Page: 3

CASE NUMBER: 502-00226 CLASSIFICATION: _____

INCIDENT: _____

DATE AND TIME: _____

REPORT CONTINUED:

The photos show pieces of the grill on the passenger and driver side which are missing. Several key pieces of grill found at the HOCHSTETLER hit & run scene are still intact on this truck. The chrome bumper has a rounded, impact dent with the RP should be which would be consistent with striking a rounded object, something like a tree. There was no hood or radiator damage which is apparent from the photos.

I do not believe that this is the suspect vehicle we are looking in the HOCHSTETLER incident.

Contact was made by phone with Sgt. Evancheck. I thanked him for his assistance and the photos. MJBushman /bjc

Noticed Marinette Co. S.O.
I month Ago Noticed Chevy
Pickup - Grill Knocked out

Pete Santalupo

Crivitz

"Jack" #
Laverne F. Gasper

[Redacted] Cth B

Crivitz

Yes
85-89 Chevrolet

Brownish - Parked Next ~~to~~

20 miles East

No Plates

Broken out - upper right
By Head light - Piece
missing lower left →

Bumper has Dent in it.

No Front Plate



MANTOWOC COUNTY SHERIFF'S DEPARTMENT

1025 South 9th Street
Manitowoc, Wisconsin 54220

Phone [REDACTED] ★ Fax [REDACTED]



F A X

DATE 01-11-02

TO: Marquette Co. Sheriff

ATTN: Sgt. EvancheK

FAX #: [REDACTED]

FROM: Lt. G. Schetter MTSO

NUMBER OF PAGES SENT INCLUDING THIS ONE 2

CONFIDENTIALITY NOTICE

This message is intended only for the use of the individual or entity to which it is addressed and may contain information that is privileged, confidential, and exempt from disclosure under applicable law. If the reader of this message is not the intended recipient or the employee or agent responsible for delivering the message to the intended recipient, you are hereby notified that any dissemination, distribution, or copying of this communication is strictly prohibited. If you have received this communication in error, please notify us immediately by telephone and return the original message to us via the U.S. Postal Service. Thank you.

SHERIFF'S DEPT FAX NUMBERS: [REDACTED]
[REDACTED] - Detectives [REDACTED] - Dispatch [REDACTED] - Jail [REDACTED] - Juvenile
[REDACTED] - Metro [REDACTED] - Records/Administration



MANITOWOC COUNTY SHERIFF'S DEPARTMENT

1025 South 9th Street
Manitowoc, Wisconsin 54220

Phone [REDACTED] ✖ Fax [REDACTED]



01-11-02

To: Marinette Co. S.O.

We received a Crime Stoppers call reference a fatal hit and run accident that occurred in our county on Jan 10th 1999. The person calling resides in your jurisdiction and we are requesting your assistance to get some information from the vehicle in question.

The suspect vehicle we are looking for should be a 85-89 Chevrolet pickup, blazer, or van style with square type front grill. There should be damage to front grill area, with pieces missing.

Our caller is a Laverne (Jack) F Gasser. He resides at [REDACTED] Cth G Crivitz WI with a phone number of [REDACTED]. Mr. Gasser would be willing to meet with an officer and take the officer to vehicle in question.

Gasser indicates that he has observed a brownish chev pickup truck parked on some property about 20-25 miles east of Crivitz. This vehicle appears abandoned and has pieces of the front grill missing along with damage to front bumper. There is no front reg. plate attached to vehicle. Mr. Gasser would be willing to meet with an officer and take him to the location of this truck for an officer to check it out.

We are asking if an officer could meet with Mr. Gasser and inspect the vehicle further and pass along any information available. Things of interest to us would be a VIN number, color, year of vehicle, description of damage and anything else that of interest. We would also greatly appreciate some pictures of vehicle, concentrating on the front of the vehicle. If you could forward your findings to our Department sending it attention to Deputy Inspector Bushman ASAP

If you have any questions you can contact us at [REDACTED] and ask to speak with the shift commander.

Thanks for all your assistance.

Lt. Gregg J Schetter

INCIDENT HISTORY DETAIL: X020460347

INITIATE: 20:49:07 02/15/02 CALL NUMBER: X0347
ENTRY: 20:54:49 CURRENT STATUS: CLOSED
DISPATCH: PRIMARY UNIT:
ONSCENE: CASE NUMBER: SO0200001186
CLOSE: 20:54:49 DISPOSITION:

LOCATION: 1025 S 9 ST ,MTW (MANITOWOC COUNTY)

LOCATION COMMENTS:

DAREA: MTSO

BEAT: UNK

RD: 52067

TYPE: CS

CRIME STOPPERS

PRIORITY: 5

20:54:49 DW02 ENTRY TEXT:CALLER IS AN EMPLOYEE OF MILLS FLEET FARM AND SAW
A BALCK SUBURBAN WITH NO GRILL AND DRIVER'S SIDE
DAMAGE. COULD NOT SEE THE OTHER SIDE. POSSIBLE PLATE
OF WI RP QRT821 OR QRZ821. \COMP: [REDACTED]
06231944 \LOC [REDACTED] PH: [REDACTED]

20:54:49 DW02 CLOSE CLOSED EVENT ENTERED
20:55:08 DW02 CASE SO0200001186 Assigned *146034*

OPERATOR ASSIGNMENTS: DW02 D935 STECKMESSER, LYNN

- 1 UNFOUNDED
- 2 INL
- 3 OTHER
- 4 CLEARED
- 5 EXCEPT (CLEAR)

OFFENSE TYPE

- 1 ADULT
- 2 JUVENILE
- 3 UNKNOWN

FILE APPROVAL

DV

02.15.02

MANITOWOC COUNTY SHERIFF'S DEPARTMENT
FOLLOW-UP REPORT

Page: 2

CASE NUMBER: 502-01180 CLASSIFICATION: _____

INCIDENT: _____

DATE AND TIME: _____

REPORT CONTINUED:

02/20/02: I, D.I. M. Bushman, received this Crime Stoppers report in my drawer with the Crime Stopper Interview Form attached. The caller is listed on the form and he is an employee of MILLS FLEET FARM. While working, the caller did observe a black Chevrolet Suburban with no grill and driver side damage. The caller felt the vehicle may have been involved in the HOCHSTETLER fatal hit & run accident (S99-00242). This call was placed on 02/15/02 while the caller had the vehicle inside at FLEET FARM. No squad was immediately sent, and the vehicle left the area.

A possible RP is QRT821 or QRZ821. Both RPs were run through DOT as an auto and as a truck RP by Dispatch. There is no record for that RP.

Five attempts were made to contact PHILIP KOCH at his home phone of [REDACTED] and his cell phone of [REDACTED]. Messages were left on the answering machine; however, there was no response.

At this time, this complaint can be closed, pending new leads. MJBushman /bjc

INCIDENT HISTORY DETAIL: X022280239

INITIATE: 13:18:23 08/16/02 CALL NUMBER: X0239
ENTRY: 13:19:45 CURRENT STATUS: CLOSED
DISPATCH: PRIMARY UNIT:
ONSCENE: CASE NUMBER: SO0200006668
CLOSE: 13:19:45 DISPOSITION:

LOCATION: [REDACTED] S RAPIDS RD ,MTW (MILLS FLEET FAR)

LOCATION COMMENTS:

DAREA: MTSO

BEAT: UNK

RD: 52091

TYPE: SUSP VEHICLE

PRIORITY: 2

6301 CS

13:19:45 DW01 ENTRY TEXT:REPORTS SEEING A VAN THAT MAY HAVE BEEN INVOLVED
IN THE RICHARD HOSTETLER INCIDENT S99-00242 \COMP:ANON
13:19:45 DW01 CLOSE CLOSED EVENT ENTERED
13:19:52 DW01 CASE SO0200006668 Assigned
13:23:56 DW01 MISC .239, SUSPECT VEH RP# RCY445
13:25:13 DW01 MISC .239, CHEVY OR GMC WHITE FULL SIZED FRONT END
DAMAGE-NO GRILL-LIGHTS WIRED YOUNGER DRIVER
POSSIBLY 30'S W/LONG HAIR

OPERATOR ASSIGNMENTS: DW01 D962 GROTEGUT, CARLA

1 UNCHARGED
2 OTHER
3 OTHER
4 CLEARED
5 EXCEPT CLARIFIED

OFFENSE TYPE
1 ADULT
2 JUVENILE
3 UNKNOWN

FILE APPROVAL

BY *WEB*

DATE *08/16/02*

MANITOWOC COUNTY SHERIFF'S DEPARTMENT
FOLLOW-UP REPORT

Page: 2

CASE NUMBER: 502-066128 CLASSIFICATION: _____

INCIDENT: _____

DATE AND TIME: _____

REPORT CONTINUED:

O	BEHRMANN	²³¹³⁷ JOHN	E	██████████	██████████	Main St, Mishicot	██████████
V	HOCHSTETLER	¹⁴¹⁰³⁴ RICHARD	D	██████████			

08/16/02 @ 1135 Hrs.: I, Deputy E. Glaeser, was informed by D.I. M. Bushman of a Crime Stoppers complaint with information on a vehicle that could be connected to the RICHARD HOCHSTETLER incident.

08/17/02 @ 0558 Hrs.: I ran the RP of RCY445, and it indicated that the vehicle was registered as a 1986 Chevy van to JOHN BEHRMANN from Main St in Mishicot.

I responded to ██████ S Main St, Mishicot, where I observed the front end of the vehicle. It should be noted the truck in question is a gray Chevy _____ van, full-size, and it did have damage to the grill area and a dent to the front bumper. Attempts to contact BEHRMANN at his residence met with negative results.

It should be noted that one of the members of Dispatch is familiar with BEHRMANN. This party relayed that BEHRMANN damaged the vehicle by striking a tree on his own property within the last year.

08/17/02 @ 1100 Hrs.: I received a telephone call from BEHRMANN. He indicated to me that his vehicle had been checked earlier, near the time of the HOCHSTETLER hit & run. The vehicle checked out at that time. BEHRMANN stated he struck a tree on his property and damaged the front grill within the last 6 months. He further relayed that just the other day, he removed the rest of the grill pieces because he was afraid of them falling out onto the roadway. BEHRMANN was advised that I checked the front of the vehicle and it did appear that the damage was inconsistent with our hit & run complaint.

Information on BEHRMANN'S vehicle, his date of birth, and his address were entered onto the FBI program.

No further action needed. EJGlaeser

/bjc

1410

INCIDENT HISTORY DETAIL: X021450229

INITIATE: 14:10:00 05/25/02 CALL NUMBER: X0229
ENTRY: 14:11:50 CURRENT STATUS: CLOSED
DISPATCH: PRIMARY UNIT:
ONSCENE: CASE NUMBER: SO0200004067
CLOSE: 14:11:50 DISPOSITION:

LOCATION: 1025 S 9 ST ,MTW (MANITOWOC COUNTY)

LOCATION COMMENTS:

DAREA: MTSO
BEAT: UNK TYPE: CS S99-00242
RD: 52067 PRIORITY: 5

14:11:50 DW01 ENTRY TEXT:CALLER HAD POSSIBLE SUSPECT IN THE FATAL HIT AND
RUN ACCIDENT OF RICK HOCHSTETLER. \COMP:ANONYMOUS
14:11:50 DW01 CLOSE CLOSED EVENT ENTERED
14:12:01 DW01 CASE SO0200004067 Assigned

OPERATOR ASSIGNMENTS: DW01 D935 STECKMESSER, LYNN

- 1 UNFOUNDED
- 2 PNL
- 3 OTHER
- 4 CLEARED
- 5 EXCEPT (CURRED)

OFFENSE TYPE
1 ADULT
2 JUVENILE
3 UNKNOWN

FILE APPROVAL

BY: WRB

DATE: 05/31/02

MANITOWOC COUNTY POLICE DEPARTMENT

MANITOWOC COUNTY SHERIFF'S DEPARTMENT
FOLLOW-UP REPORT

Page: 2

CASE NUMBER: 502-04067 CLASSIFICATION: _____

INCIDENT: _____

DATE AND TIME: _____

REPORT CONTINUED:

O	HAUCKE	4398	RICKEY	D	██████████	██████████	E Goodwin Rd, Manitowoc	██████████
V	HOCHSTETLER	146034	RICHARD	D	05/13/81			

05/30/02: Information on this Crime Stopper was that RICKEY HAUCKE got rid of a van shortly after the fatal accident involving RICHARD HOCHSTETLER (see incident S99-00242). This is an invalid complaint due to the lack of information. There is no call-back number. The person remained anonymous and hung up before any information could be received. According to the FBI lab analysis which was done on the parts and pieces from the grill, a van is not a vehicle to be looked at; therefore, this Crime Stopper can be closed.
JMLenk /bjc

INCIDENT HISTORY DETAIL: X033020181

INITIATE: 11:39:07 10/29/03 CALL NUMBER: X0181
ENTRY: 11:40:45 CURRENT STATUS: CLOSED
DISPATCH: PRIMARY UNIT:
ONSCENE: CASE NUMBER: SO0300009500
CLOSE: 11:40:45 DISPOSITION:

LOCATION: GREEN LAKE CO
LOCATION COMMENTS:
DAREA: MTSO
BEAT: UNK
RD:

GEO OVERRIDE
TYPE: PINFO H&R FOLLOW-UP
PRIORITY: 5

11:40:45 DW13 ENTRY TEXT:COMPLAINANT IS AN OVER-THE-ROAD TRUCKER WHO
SPOTTED A POSSIBLE SUSPECT VEHICLE FROM S99-00242 HIT
AND RUN PARKED AT THE INTERSECTION OF CTH A AND CTH S
IN GREEN LAKE CO. \COMP:RICHARD J BUDA \LOC: [REDACTED] S
26TH ST., MANITOWOC WI 54220 \PH: [REDACTED]
11:40:45 DW13 CLOSE CLOSED EVENT ENTERED
11:40:50 DW13 CASE SO0300009500 Assigned

OPERATOR ASSIGNMENTS: DW13 S592

MANITOWOC COUNTY SHERIFF'S DEPARTMENT INCIDENT

CASE No. 503 - 09500

- | | |
|-------------------|---------------|
| 1. Unfounded | 1. Adult |
| 2. PNL | 2. Juvenile |
| 3. Other | 3. Unknown |
| 4. Cleared | File Attached |
| 5. Except Cleared | Date 10/29/03 |

MANITOWOC COUNTY SHERIFF'S DEPARTMENT
FOLLOW-UP REPORT

Page: 2

CASE NUMBER: 303-09500 CLASSIFICATION: _____

INCIDENT: _____

DATE AND TIME: _____

REPORT CONTINUED:

V	HOCHSTETLER ^{H0084}	RICHARD	D	05/13/81		
W	BUDA ³²²³⁶	RICHARD	J	██████████	██████████ S 26th St, Manitowoc	██████████
O	GREEN LAKE CO SHERIFFS DEPT	⁸³²⁶		██████████	Hill St, Green Lake	██████████
O	LUEPTOW	TIMOTHY			c/o Green Lake Co Sheriff's Dept	██████████

10/28/03: I, D.I. M. Bushman, took a phone call from RICHARD BUDA reference the RICHARD HOCHSTETLER hit & run (refer to incident S99-00242). BUDA is an over-the-road trucker who has the occasion to be in the Markesan area, making deliveries to the DEL MONTE FOOD PLANT. BUDA observed a burgundy, 1980s Chevy van which appeared to fit the description of the suspect vehicle in the HOCHSTETLER fatality. The van had right front damage, and it appeared to have a grill which did not fit for that particular model held in place in the front. It was parked "For Sale" at a white house at the intersection of CTH A and CTH S in Green Lake Co.

Contact was made with GREEN LAKE CO. SHERIFF'S DEPT. to assist with follow-up, and Det. TIMOTHY LUEPTOW was assigned the case. Det. LUEPTOW went to the location and took 10 digital representations of the van and then E-mailed them to my E-mail address at MTSO.

Inspector R. Hermann and I viewed all 10 of the photos provided. Both agreed that the van should not be considered a suspect vehicle in the HOCHSTETLER fatality. Several quick reasons include the style of the van (that being more of a deluxe model) and the configuration of the headlights and the grill which would be original in the van (it does not match the description of the pieces of evidence found at the scene).

The E-mail correspondence and 2 of the printed 10 photos are attached. ^{H0084} MJBushman /bjc

Mike Bushman

From: Lueptow, Tim [REDACTED]
Sent: Tuesday, October 28, 2003 14:23
To: Mike Bushman (E-mail)
Subject: photos



P001266.BMP



P001267.BMP



P001268.BMP



P001269.BMP



P001270.BMP



P001271.BMP



P001272.BMP



P001273.BMP



P001274.BMP



P001275.BMP

<<P001266.BMP>> <<P001267.BMP>> <<P001268.BMP>> <<P001269.BMP>>
<<P001270.BMP>> <<P001271.BMP>> <<P001272.BMP>> <<P001273.BMP>>
<<P001274.BMP>> <<P001275.BMP>>

Green Lake County Sheriff's Department

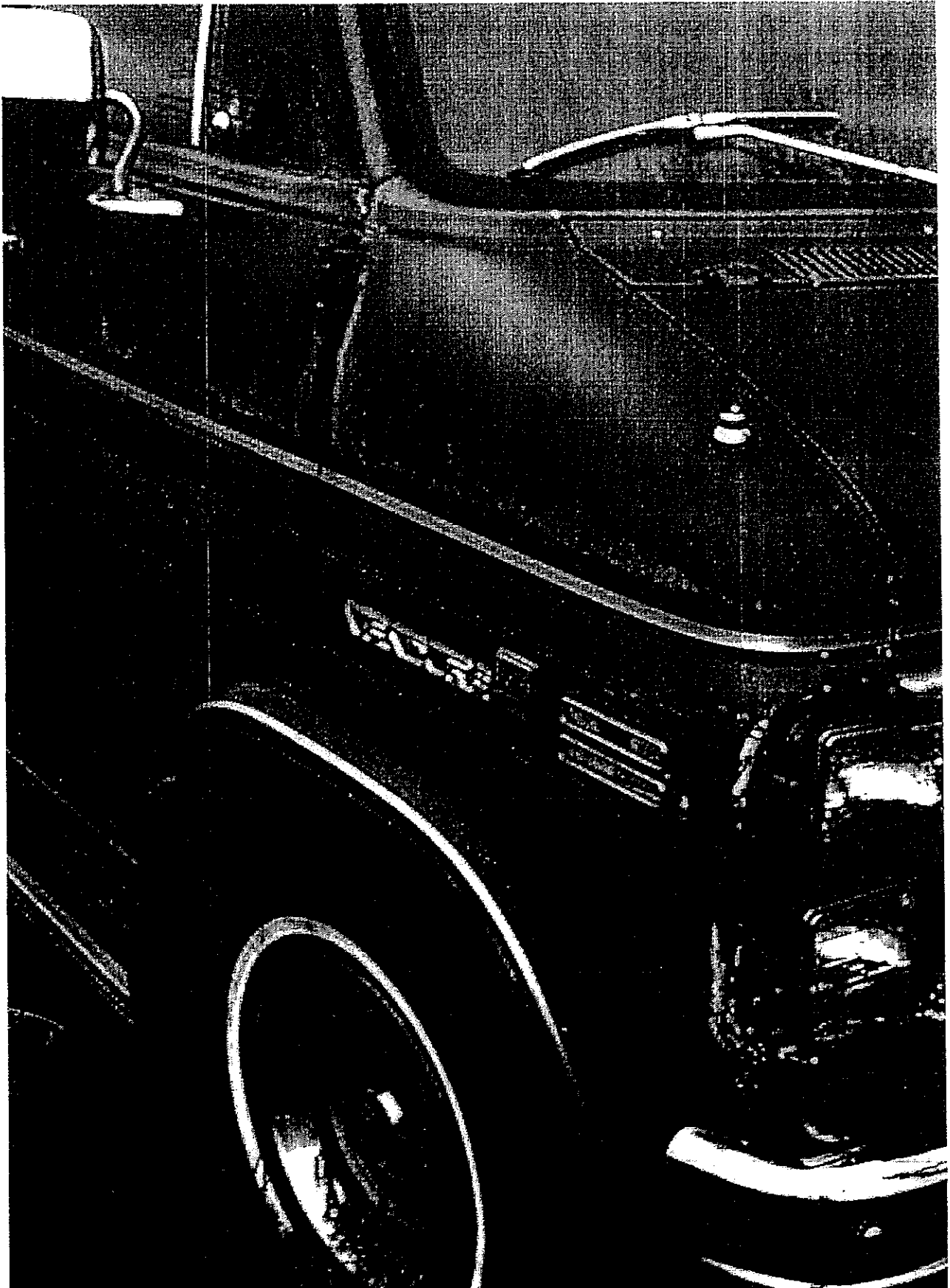



INCIDENT HISTORY DETAIL: X031950260

INITIATE: 15:38:10 07/14/03 CALL NUMBER: X0260
ENTRY: 15:39:07 CURRENT STATUS: CLOSED
DISPATCH: PRIMARY UNIT:
ONSCENE: CASE NUMBER: SO0300006090
CLOSE: 15:39:07 DISPOSITION:

LOCATION: [REDACTED] 26 ST ,TR (WEST & SCHOOL)

LOCATION COMMENTS:

DAREA: MTSO

BEAT: UNK

RD: 2160

TYPE: PINFO INFORMATION ONLY

PRIORITY: 5

549-00242

15:39:07 DW01 ENTRY COMP:DI BUSHMAN
15:39:07 DW01 CLOSE CLOSED EVENT ENTERED
15:39:15 DW01 CASE SO0300006090 Assigned

OPERATOR ASSIGNMENTS: DW01 D959 XXX

146034

MANTOWOC COUNTY SHERIFF'S DEPARTMENT INCIDENT

CASE No. S03 - 06090

JUVENILE
PNI
 OTHER
Cleared
EXCEPT

OFFENSE TYPE
1 ADULT
2 JUVENILE
3 UNKNOWN

OFFICER APPROVAL

WAB

DATE 07/17/03

INCIDENT HISTORY DETAIL: X031950250

INITIATE: 15:09:44 07/14/03 CALL NUMBER: X0250
 ENTRY: 15:11:09 CURRENT STATUS: CLOSED
 DISPATCH: 15:13:16 PRIMARY UNIT: T842
 ONSCENE: 15:15:19 CASE NUMBER: TR0300003477
 CLOSE: 15:38:05 DISPOSITION: HBO

LOCATION: [REDACTED] 26 ST ,TR (WEST & SCHOOL)

LOCATION COMMENTS:

DAREA: TRPD
 BEAT: T02 TYPE: AOLEA ASSIST OTHER LAW
 RD: 2160 PRIORITY: 4

15:11:09 DW02 ENTRY TEXT:DI BUSHMAN WOULD LIKE AN OFFICER TO RESPOND TO THE ABOVE LOCATON TO CHECK ON A VEHICLE RP#463193. DI BUSHMAN WOULD LIKE THE OWNER SPOKEN WITH TO SEE IF THERE IS AN EXPLANATION TO THE DAMAGE THAT IS ON THE VEHICLE AND TO SEE IF MAY \COMP:MTSO(DI BUSHMAN) PH:6834212

15:11:43 DW02 SUPP TEXT:BE RELATED TO INC#S99-00242

15:13:16 DW02 DISPATCH T842

15:13:16 DW02 ID T842 <T842>KEERY, DAVID

15:14:28 DW02 ENROUTE T842

15:15:19 DW02 ONSCENE T842

15:33:41 DW02 MISC T842, OFFICER MADE CONTACT WITH 141 AT MTSO

15:36:47 DW04 CASE TR0300003477 Assigned

15:38:05 DW02 CLEAR T842 HBO, NOT THE VEHICLE

15:38:05 DW02 CLOSE T842 HBO, NOT THE VEHICLE

OPERATOR ASSIGNMENTS: DW02 D956 XXX
 DW04 D949 XXX

CASE DISPOSITION:

ARREST COMPLETED INACTIVE ACTIVE UNFOUNDED

***COMPLAINANT NOTIFIED ***

DATE COMPLETED: 07-15-03 Jon

TWO RIVERS POLICE DEPARTMENT

Date: 7/16/2003

Page: 1

Case Number: 2003-00003477

Case Description:
Request From/To Outside Authorities

Primary Victim: NONE

Date/Time Reported: 7/14/03 15:09 Hrs. Dispatch Incident Type:
Date/Time Occurred: 7/14/03 15:09 Hrs. ReqFrom/To
Date/Time Between : 7/14/03 15:38 Hrs.
Location Occurred : █████ 26TH ST
Cross Street . . . :
Area: BEAT 2 Section: 2160 Grid:

Reporting Officer : 842 KEERY, DAVID, J,
Primary Unit Assigned to Investigate:
Scene Processed by:
Assigned Investigators:

Case Status: Closed Disposition: Disp. Date: 0/00/00
No. of Offenses: No. of Offenders: No. of Victims:

SUBJECTS:

Informatnl : Present Information
Primary JOHNSON, JAMES, J, Phone: ██████████
 █████ 26 ST
 TWO RIVERS WI 54241

Race : White Sex: Male D.O.B: ██████████ Age: 77
Hgt : 5'06" Wgt: 152 Hair: Eyes . . . :
Build: Complexion: Ethnicity:
Dr Lic #: St: Soc Sec #:

Business: Phone:

Residence Type : Residence Status :
Extent of Injury: Medical Treatment:
Injury Type . . . : Injury Type . . . :
Hospital/Clinic : Transported by . . . :
Statement Type : Related Offenses :

Suspect Vehicle:

Vehicle Year: 1978 Description: 78 CHEV TRUCK
Make . . . : CHEVROLET Model : Style . . . : Truck
Color Top . . : Unknown Bottom: Unknown Interior: Unknown
License # . . : ██████████ State : WI Year: 0 Type: Truck/Comm
Serial #/VIN: ██████████ OAN . . . :
Vehicle Type: Truck Engine #:
Reported . . : 7/14/03 15:09 Hrs. Venue . . : Two Rivers
Area . . . : BEAT 2 Section: 2160 Grid . . :
Location . . : █████ 26TH ST
Cross Street:

narrative

TWO RIVERS POLICE DEPARTMENT

Date: 7/16/2003

Page: 2

Case Description:
Request From/To Outside Authorities

Case Number: 2003-00003477

Deputy Inspector Bushman requested officer check a truck at [REDACTED] 26th St with WI registration [REDACTED]. He received an anonymous tip that this vehicle may have been involved in a fatal hit and run in Manitowoc County in 1999. I had phone contact with Dep Insp Bushman and confirmed this vehicle's grill did not match the grill of the suspect vehicle. Parts collected at the scene and retained as evidence. The owner stated he has owned the vehicle since at least 1989. Please forward to Dep Insp Bushman at MTSO ASAP.

INCIDENT HISTORY DETAIL: X033040116

INITIATE: 09:06:02 10/31/03 CALL NUMBER: X0116
ENTRY: 09:07:51 CURRENT STATUS: CLOSED
DISPATCH: PRIMARY UNIT:
ONSCENE: CASE NUMBER: SO0300009566
CLOSE: 09:07:51 DISPOSITION:

LOCATION: CR/SILVER CREEK RD N ,MTW (CR/SILVER CREEK RD N)
LOCATION COMMENTS:
DAREA: MTSO
BEAT: UNK MAP PAGE: FIE TYPE: PINFO FATAL
RD: 14012 PRIORITY: 5

09:07:51 DW01 ENTRY TEXT:RE: FATAL S99-00242 DET REMIKER \COMP:MARC
LECLAIR \LOC: [REDACTED] N 15 \PH: [REDACTED]
09:07:51 DW01 CLOSE CLOSED EVENT ENTERED
09:07:57 DW01 CASE SO0300009566 Assigned
OPERATOR ASSIGNMENTS: DW01 D901 XXX

278
/H1

MANITOWOC COUNTY SHERIFF'S DEPARTMENT INCIDENT

CASE No. S03 -

09566

- 1. Unfounded
 - 2. 2 INL
 - 3. 3 Other
 - 4. Cleared
 - 5. Except Cleared
- 1. Adult
 - 2. Juvenile
 - 3. Unknown
 - File Approval WAB
 - Date 12/2/03

MANITOWOC COUNTY SHERIFF'S DEPARTMENT
FOLLOW-UP REPORT

Page: 2

CASE NUMBER: 503-09566 CLASSIFICATION: _____

INCIDENT: _____

DATE AND TIME: _____

REPORT CONTINUED:

V	HOCHSTETLER ¹⁴⁶⁰³⁴	RICHARD	D	05/13/81		
W	LECLAIR ³⁶¹⁹¹	MARC	E	██████████	██████████ N 15th St, Manitowoc	██████████
O	NEFF ²⁴⁷⁰⁷	TODD	R	██████████	██████████ S 7th St, Manitowoc	██████████
S	HER ²⁰⁹⁹¹	CHOU	*NMI*	██████████	██████████ S 10th St, Manitowoc	

10/28/03: I, Det. Remiker, spoke with D.I. M. Bushman reference this complaint. D.I. Bushman stated an individual by the name of MARC LECLAIR came to MTSO to provide some information reference the fatal hit & run accident on CTH CR which occurred in 1999 (see incident S99-00242). D.I. Bushman provided the following information to me reference his contact with LECLAIR.

LECLAIR stated he had some information to provide reference the hit & run fatal accident on CTH CR in which a young male subject was struck and killed by a hit & run vehicle. LECLAIR was bothered by some observations that he had the day after the accident occurred. LECLAIR identified a male subject by the name of CHOU HER. LECLAIR stated HER worked at NATURAL OVENS with him at the time of the accident. LECLAIR stated the day after the accident occurred, HER was late for work. LECLAIR thought this was very unusual because HER normally would arrive prior to other individuals arriving for work. LECLAIR stated he believed HER operated a pickup truck with a cap.

LECLAIR stated a call was placed to HER'S residence a day after the accident occurred because HER was not into work yet. LECLAIR stated HER'S wife answered the phone and indicated that HER was not home at the time. LECLAIR indicated that a second phone call was placed to HER'S residence. At that time, LECLAIR talked with HER who indicated that he was on his way to work. LECLAIR believed that this was very suspicious because the first call indicated he was not home and the second call indicated he was home. LECLAIR stated HER arrived at NATURAL OVENS with his son's vehicle which LECLAIR identified as a Mitsubishi. LECLAIR thought this was very suspicious. LECLAIR indicated that HER always drove an old pickup truck (he indicated he did not know the make or model). LECLAIR stated HER then began operating a newer vehicle which he believed was a Toyota Tundra shortly after the accident.

LECLAIR stated, once HER arrived at work, several individuals were looking outside of NATURAL OVENS, toward the scene of the accident. LECLAIR indicated there were "a hundred squads" outside near the traffic accident scene. LECLAIR stated HER refused or did not look outside as others were looking at the traffic accident scene.

LECLAIR stated another individual who he worked with by the name of TODD NEFF may have also had similar observations and may be able to provide further information.

D.I. Bushman indicated to me that he placed a phone call to a subject at DOT. Arrangements

MANITOWOC COUNTY SHERIFF'S DEPARTMENT
FOLLOW-UP REPORT

Page: 3

CASE NUMBER: 503-09566 CLASSIFICATION: _____

INCIDENT: _____

DATE AND TIME: _____

REPORT CONTINUED:

were made to conduct a vehicle record check on CHOU HER which would indicate any vehicles registered or owned by CHOU HER in the past. Arrangements were made to have the record check faxed to MTSO.

10/28/03 @ 0939 Hrs.: The record check was faxed to D.I. Bushman. The record check dated back to 1996; and areas were highlighted on the record check, referring to CHOU HER'S vehicles. Upon reviewing the 8-page record check, it was noted that all vehicles registered and owned by HER were of a foreign make and model. One vehicle did reveal a 1993 Chevrolet make vehicle. Authorities have determined that the suspect vehicle involved in the hit & run is definitely a 1985-1989-year vehicle. Based on the records provided by DOT, CHOU HER did not have any vehicles owned or registered to him, similar to the vehicle being pursued as the hit & run vehicle.

It was determined to make contact with TODD NEFF in an attempt to obtain further information.

10/28/03 @ 1445 Hrs.: I, Det. Remiker, placed a phone call to TODD NEFF'S residence at [REDACTED] I received no answer at the residence.

10/28/03 @ 1820 Hrs.: I again attempted contact with NEFF but met with negative results.

10/31/03 @ 0850 Hrs.: I attempted contact at NEFF'S residence and again received no answer.

10/31/03 @ 1450 Hrs.: I placed a phone call to NEFF'S residence but met with negative results.

11/01/03 @ 0840 Hrs.: I called Information who provided me with the same phone number for NEFF at the S 7th St address.

11/03/03 @ 1905 Hrs.: I attempted contact with NEFF again but met with negative results.

11/07/03 @ 0915 Hrs.: I attempted contact with NEFF but met with negative results.

11/10/03 @ 0847 Hrs.: I again attempted contact with NEFF but met with negative results.

I will continue to attempt to contact NEFF for further follow-up on this incident. I believe contact with NEFF is vital, prior to conducting any further follow-up.
DERemiker /bjc

11/18/03: I, Det. Remiker, met with TODD NEFF at his address on S 7th St in the City of Manitowoc. I informed NEFF that I was investigating this incident reference the hit & run which occurred. NEFF was asked about an individual who he worked with at NATURAL OVENS around the time of the incident.

NEFF recalled CHOU HER as a co-worker of his. NEFF stated he recalled the date that the

MANITOWOC COUNTY SHERIFF'S DEPARTMENT
FOLLOW-UP REPORT

Page: 4

CASE NUMBER: 503-09566 CLASSIFICATION: _____

INCIDENT: _____

DATE AND TIME: _____

REPORT CONTINUED:

accident was being investigated by officers outside of NATURAL OVENS. NEFF stated he did not see anything out of the ordinary, nor does he recall any actions by HER that would lead him to be suspicious of his involvement in the accident. NEFF stated he does not recall HER operating an older pickup truck during this time. NEFF stated he is positive that the only vehicles HER was operating at this time were of a foreign make. NEFF stated he knows that HER did not own or operate a 1985-1989 model pickup truck or this type of vehicle during the time. NEFF assured me that HER only operated vehicles such as Nissan, Isuzu, and Toyota trucks. NEFF stated he would recontact me if he could remember any other specifics reference this complaint.

I, Det. Remiker, went to CHOU HER'S residence on S 10th St in the City of Manitowoc. HER was not home at this time, but I spoke with several family members who were present. I was advised by the family members that HER has never owned a vehicle similar to what was described to the family. HER'S family stated all vehicles that HER operated in the past were of a pickup type of vehicle and either Isuzu, Toyota, or Nissan types. HER'S family stated HER did not own a Chevrolet or GMC type of vehicle similar to the make and model being pursued. HER'S family requested my business card which was provided to them for HER to contact me at in the future.

At this point, I believe there is no evidence to link CHOU HER or any of CHOU HER'S vehicles to this incident. In speaking with NEFF, he was clear that HER did not own or operate a vehicle similar to the vehicle involved in the hit & run. Also, records through DOT do not show a vehicle owned or registered to CHOU HER similar to the vehicle involved in the hit & run.

I will speak with CHOU HER once he contacts me to verify some information.

At this point, this case can be closed, pending any new leads. DERemiker /bjc

Contact was made with CHOU HER at his residence. A discussion took place with HER reference him owning any vehicles within the time frame of the suspect vehicle involved in the hit & run accident. HER was very consistent with his information, including the vehicles that he owned and had registered at the time the accident occurred. HER stated he never owned a vehicle at the time of the accident between a 1985 and 1989 year of vehicle. HER indicated the only American-made vehicle that he owned around that time was a 1993 Chevrolet vehicle.

All indications are that CHOU HER or any vehicles owned by CHOU HER were not involved with this accident. This incident can be closed. DERemiker /bjc

ref. to
99-00242

SUC

~~ADVIS~~

S. 10TH

22997	HRN	CHOU	[REDACTED]	[REDACTED]	[REDACTED]
71471	HRN	CHOU	[REDACTED]	[REDACTED]	[REDACTED]
96750	HRN	CHAO L.	[REDACTED]	(C) noc's	[REDACTED]
102624	HRN	CHOUA	[REDACTED]	[REDACTED]	[REDACTED]

24207	NEFF	TODD R.	[REDACTED]	[REDACTED]	[REDACTED]
<u>WILL</u>	[REDACTED]	SO. 7TH	MTWC	[REDACTED]	[REDACTED]
26191	RECLAIM	E. MARG	[REDACTED]	[REDACTED]	[REDACTED]
<u>ADVIS</u>	[REDACTED]	N. 15TH	MTWC	[REDACTED]	[REDACTED]

10/28/03

0835 KANEY NAT QUENS HUMAN RESOURCES
 CHOU HRN STILL CURRENTLY EMPLOYED THESE
 VERIFIED JOB OF SUS. [REDACTED]
 0948 AOT "DOUG" GEP [REDACTED] WILL FAX WATER
 THIS MORNING. CHECK GOES BACK TO 1996

10-28-03 - 1445 hrs (-) contact w/ Todd Neff
 1820 (-)
 10-31-03 ~~0850~~ 0850 hrs. (-)

10/28/03
 11:12

"CHEWY" 30-40 E

CHOU HENK,

NATURAL OUVENS
TRUCK

~~WIFE
WAS
DRIVING
CAR
WAS
DRIVING~~

LATE FOR WORK

HAND TO REAK - (MUNG)

LET CALL WASN'T HOME WIFE ANSWERED / BROUGHT SON'S
MITSUBISHI IN

P/U w/ CAR

WASN'T HOME WIFE ANSWERED / BROUGHT SON'S
MITSUBISHI IN

WOULDN'T BE ABLE TO GIVE A STRAIGHT ANSWER
ALWAYS REAK RE CLATS TO AND WOULD SLEEP

LEOASA [REDACTED]

DET. [scribble]

- 1) ALWAYS INTO WORK EARLY, LATE THAT DAY
- 2) CALLED WIFE SHE SAID HE WASN'T HOME
- 3) JNA CALL ~~WIFE~~ TALKED WITH ~~HEM~~ "ON HIS WAY"
- 4) SHOWED UP W/ HIS SON'S MITSUBISHI (SPRO MOUNTING)
- 5) ALWAYS (DROVE) AN ^{OLD} P/U - SOON AFTER NEW VEH. TOYOTA TUNDRA

NOT FANCY LIKE AN
OLD / OLD FARM TRUCK / W/ TOP

WOULD NOT LOOK OUTSIDE "MUST
HAVE BEEN 100 SQUARES"

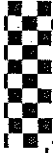

Total Pages Transmitted
Including Transmittal 14

FACSIMILE TRANSMITTAL

Date Transmitted
10-28-3

Please deliver the following page(s).

FAX: [REDACTED]

TELEPHONE:

FAX:

TELEPHONE:

TO: Mike Bushman

FROM: Wisconsin Department of Transportation
Doug N16

- MESSAGE -

INCIDENT HISTORY DETAIL: X033350192

INITIATE: 13:25:19 12/01/03 CALL NUMBER: X0192
ENTRY: 13:26:56 CURRENT STATUS: CLOSED
DISPATCH: PRIMARY UNIT:
ONSCENE: CASE NUMBER: SO0300010573
CLOSE: 13:26:56 DISPOSITION:

LOCATION: CITY OF MANITOWOC

LOCATION COMMENTS:

DAREA: MTSO

BEAT: UNK

RD:

GEO OVERRIDE

TYPE: PINFO RECVD INFOMATION

PRIORITY: 5

5718

S99-00242

13:26:56 DW04 ENTRY TEXT:RECEIVED INFO REFERENCE THE HIT AND RUN FATAL
S99-00242 \COMP:ANON
13:26:56 DW04 CLOSE CLOSED EVENT ENTERED
13:27:07 DW04 CASE SO0300010573 Assigned

278
432

OPERATOR ASSIGNMENTS: DW04 D920 XXX

MANITOWOC COUNTY SHERIFF'S DEPARTMENT INCIDENT

CASE No. S03 - 16573

- 1. Unfounded
- 2. PNL
- 3. Other
- 4. Cleared
- 5. Except Cleared

- 1. Adult
- 2. Juvenile
- 3. Unknown
- File Approval
- Date

LOEB
12/15/03

**MANITOWOC COUNTY SHERIFF'S DEPARTMENT
FOLLOW-UP REPORT**

Page: 2

CASE NUMBER: 503-10573 CLASSIFICATION: _____

NCIDENT: _____

DATE AND TIME: _____

REPORT CONTINUED:

V	HOCHSTETLER	RICHARD	D	05/13/81		
0	CHRISTENSEN	TIMOTHY	D	146034 7099	██████████ ██████████	Kemper St, Manitowoc ██████████
0	KLEIN	MARY	A	53444	██████████ ██████████	Marshall St, Manitowoc ██████████
0	MCCRACKEN	GREGORY	J	87764	██████████ ██████████	E River St, Two Rivers ██████████
0	DAMM	DENNIS	J	1156	██████████ ██████████	Hubbard Cir, Manitowoc ██████████
0	DAMM AUTO REPAIR			79065	██████████	E Hillcrest Rd, Two Rivers ██████████

11/17/03 @ 1845 Hrs.: I, Det. Remiker, received a phone call from an anonymous source, stating that he had some information reference the fatal hit & run accident on CTH CR in 1999. The informant advised me that he heard TIMOTHY CHRISTENSEN may have been involved in the fatal accident. The informant stated he has spoken to individuals who work with CHRISTENSEN at BURGER BOAT in the City of Manitowoc. The informant stated employees from BURGER BOAT are hesitant to contact law enforcement to provide the information because they are afraid of CHRISTENSEN. The informant stated the suspect vehicle involved in the accident was a green Chevrolet van which CHRISTENSEN purchased from FL and drove to Manitowoc with. The informant stated CHRISTENSEN received some repair work done on the van at a location on STH 42, north of Two Rivers. This was all of the information that was provided to me. The informant stated he wished to remain anonymous.

11/18/03 @ 1300 Hrs.: I contacted the DMV and spoke with a male subject by the first name of "DOUG." DOUG stated he would be able to provide information to me from the DMV records which would contain registered vehicles registered to TIMOTHY D. CHRISTENSEN from the City of Manitowoc.

11/18/03 @ 1350 Hrs.: I received a fax from the DMV. This information contained data, showing that TIMOTHY D. CHRISTENSEN from the City of Manitowoc had a 1985 Chevrolet truck registered to him. I was informed that the vehicle had been re-registered to a different owner, as of 07/28/03. The 1985 Chevrolet truck contained a VIN of ██████████ The vehicle previously contained a WI RP of TNM391.

Upon running the VIN from the 1985 Chevrolet van, I found that it is now registered to MARY KLEIN.

I was able to identify the location where the informant stated CHRISTENSEN received repair work done to the vehicle. I found that the repair shop located at the corner of STH 42 and E Hillcrest Rd is DAMM AUTO REPAIR.

I checked KLEIN'S residence on Marshall St in the City of Manitowoc on numerous occasions but was not able to locate the suspect van.

MANITOWOC COUNTY SHERIFF'S DEPARTMENT
FOLLOW-UP REPORT

Page: 3

CASE NUMBER: 503-10573 CLASSIFICATION: _____

INCIDENT: _____

DATE AND TIME: _____

REPORT CONTINUED:

11/18/03 @ 1530 Hrs.: A gold-colored van was parked on Marshall St, in front of [REDACTED] Marshall St. The van contained WI RP NJR245. Upon running this RP, I found the VIN matched the VIN on the van which had previously been owned by CHRISTENSEN. Upon visual inspection of the van, I was not able to identify any obvious damage or obvious repair work done to it.

I, Det. Remiker, was able to locate an MTSO incident from 06/30/01, during which Lt. Lenk conducted follow-up reference the same suspect vehicle (see incident #S01-05773). At that time, it was determined by Lt. Lenk that the van was not involved in the accident.

11/18/03: Sgt. A. Colborn and I went to DAMM AUTO REPAIR in an attempt to speak with the owner. We were not able to locate anyone at the repair shop.

We went to DENNIS DAMM'S residence in the City of Manitowoc, but we could not locate him.

11/19/03 @ 1420 Hrs.: Sgt. Colborn and I went to DAMM AUTO REPAIR where we met with DENNIS DAMM who was given the information reference our investigation. DAMM stated he would be willing to provide some paperwork for review reference some auto body repair done to the 1985 Chevrolet van. DAMM explained that the suspect van was on his property for a lengthy period of time, even prior to the accident.

DAMM recalled that CHRISTENSEN had been involved in a traffic accident with another vehicle and was awaiting some repair work done. CHRISTENSEN had a work estimate completed by DAMM on 06/15/99. The work estimate also detailed information that parts were ordered for the vehicle in 11/99. DAMM stated he knows that this vehicle was not involved in the pedestrian hit & run accident. DAMM stated this would not be possible because the vehicle was on his property, awaiting repair work, at the time the accident occurred. DAMM stated he also would be able to provide the VIN from the vehicle that he conducted repair work on. We asked DAMM to recontact us with the VIN to verify that the suspect vehicle was in fact the vehicle that he completed repair work on.

11/20/03: DAMM placed a phone call to me, verifying the same VIN as the 1985 Chevrolet van which is currently owned by MARY KLEIN.

MTSO in-house records were checked in an attempt to verify that CHRISTENSEN was involved in an accident which caused damage to his vehicle. There were 2 accidents in 1986 at which time accident reports were completed by MTPD. One accident was incident #M96-05787 which occurred on 06/17/96, Document #5130207.

Sgt. Colborn retrieved this Document from MTPD. The accident listed an accident date of 06/17/96 at 1814 hours. The individual listed as Unit #1 was CHRISTENSEN, operating a 1985 Chevrolet truck, brown in color. The vehicle's VIN matches the VIN on the vehicle which we have been investigating as a possible suspect vehicle. Upon further review of the accident report, it shows that CHRISTENSEN received moderate damage to the front and front quarter panel areas of the van. This information would be consistent with the information provided by DAMM, that CHRISTENSEN was involved in a different motor vehicle accident which would

MANITOWOC COUNTY SHERIFF'S DEPARTMENT
FOLLOW-UP REPORT

Page: 4

CASE NUMBER: 503-10573 CLASSIFICATION: _____

INCIDENT: _____

DATE AND TIME: _____

REPORT CONTINUED:

have caused damage to the van.

There are no indications to link CHRISTENSEN or the 1985 Chevrolet van to the fatal hit & run accident on CTH CR (incident #S99-00242). No further follow-up will be done.

This incident can be closed. DERemiker /bjc



Wisconsin Department of Transportation

Division of Motor Vehicles
Vehicle Records
P O Box 7911
Madison, WI 53707-7911
Telephone: [REDACTED]
Facsimile (FAX): [REDACTED]

November 18, 2003

DET REMIKER
1025 S 9TH ST
MANITOWOC WI 54220

VEHICLE RECORDS INFORMATION UNIT (drw)

~~THIS IS NOT A BILL-- SEND NO MONEY.~~

(drw)

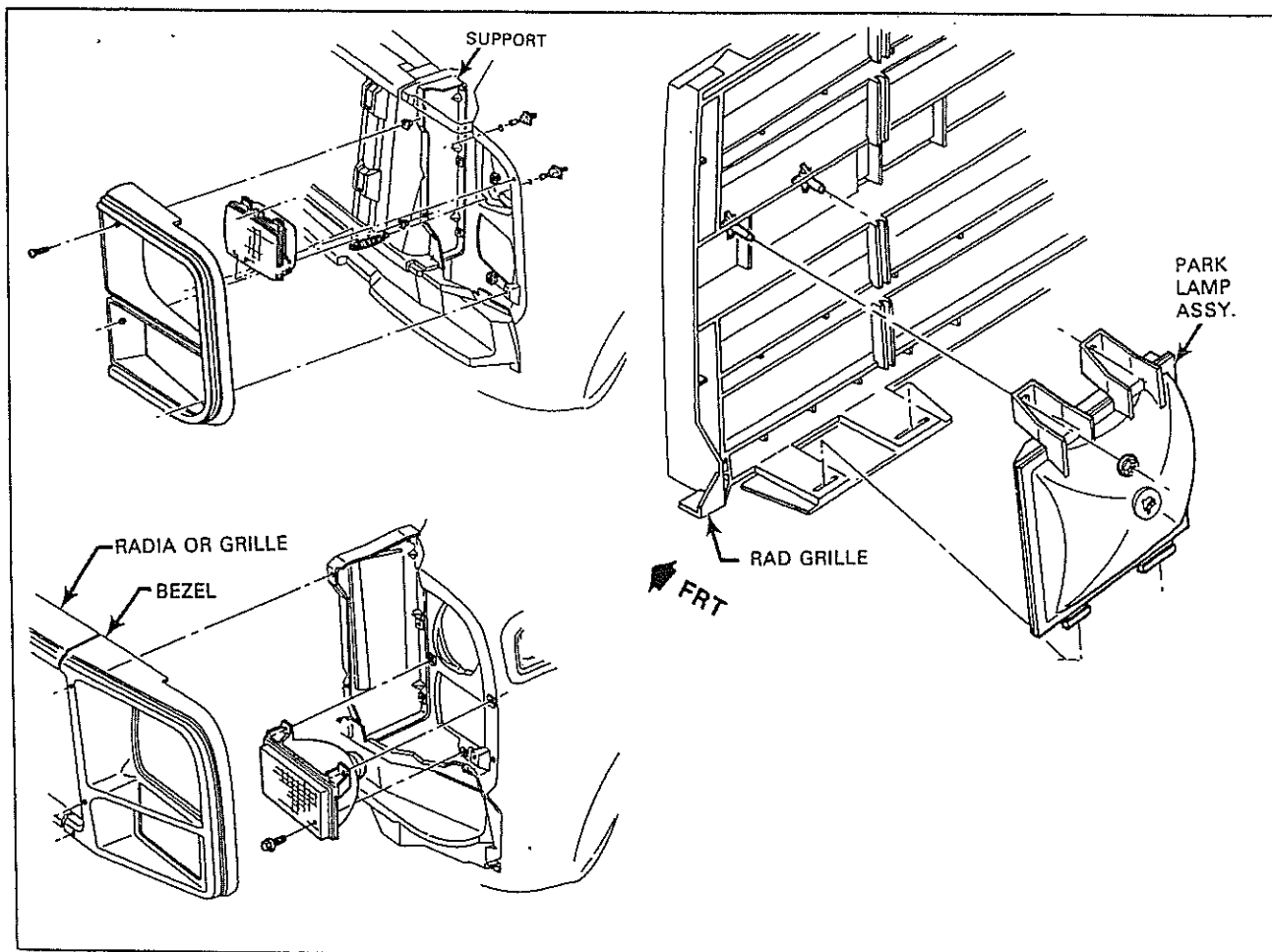

Fig. 8B-10--Front Lighting (G Models)

REAR SIDE MARKER LAMP BULB AND/OR HOUSING

C-K 03 models with E62 and G Models

Replacement

Same as Right Front Side Marker Lamp Bulb and/or Housing Replacement - All Vehicles. Bulb on G Models without interior trim may be removed from inside the vehicle.

C-K 16, 03 and 63 with E63, and 06 Models

Replacement

1. Remove lens to housing four screws.
2. Replace bulb and check operation.
3. Position lens and install four attaching screws.

Platform and Stake Rack Models (E56)

Exploded view of the different rear lighting arrangements are shown in Figures 8B-13 and 8B-14. The bulbs may be replaced by removing the lamp lens attaching screws and lamp lens. The lamp housings may be replaced by removing housing attaching nuts or screws, or by removing nuts and bolts from bracket.

TAIL, STOP AND BACKUP LAMP BULBS

Replacement

1. Remove lens to housing attaching screws.
2. Replace bulb and check operation.
3. Position lens and install attaching screws.

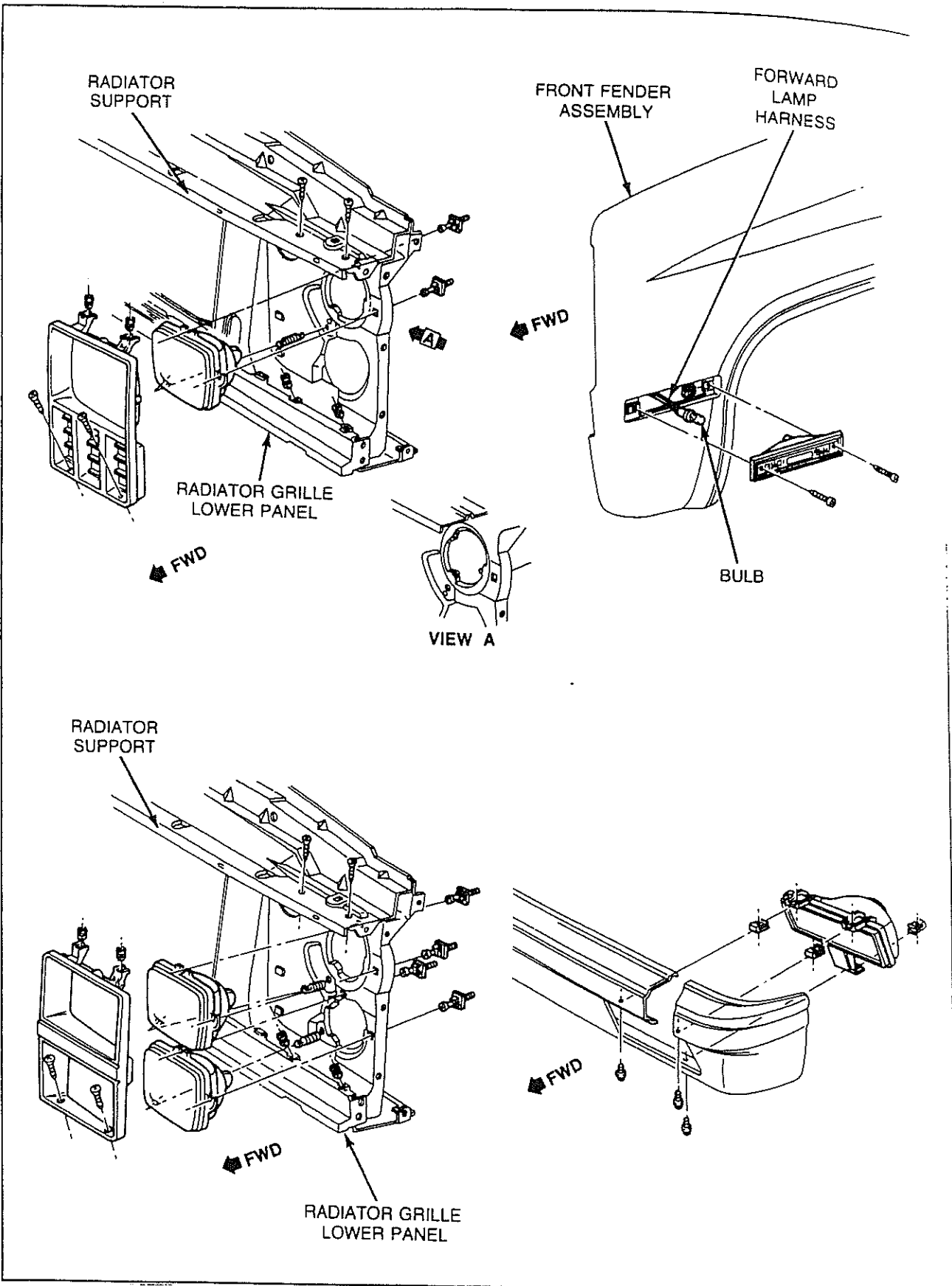

REA
AN
C-I
Re
H
W
C
F

Fig. 8B-9--Front lighting (C-K Models)

Wisconsin Motor Vehicle Accident Report

Document Number Override

Please Do Not Write In This Microfilm Space

Accident No. M96-05787

Police No. 52110

Date 06-17-96

2. Jason G. Cherney

1. Timothy Donald Christensen

Location

INSTRUCTIONS
Please use a Black Ink Pen or #2 Pencil.
Mark Areas as shown:
Correct Mark
Incorrect Marks

County: 3 6
MUN/TWP: 5 4

MON. Accident Date
MONTH DAY YEAR
1 7 9 6

Time of Accident (Military Time)
HOUR MIN.
1 8 1 4

Total Number
UNITS INJURED KILLED
0 2 0 2 0 0

Hit & Run Government Property Y
Fire (Narrative) Y
Photos Taken (Narrative) Y
Trailer or Towed (Narrative) Y
Truck or Bus (Last Page) Y
Load Spillage Y
Construction Zone Y
Names Exchanged Y

Sheet No. Of
1 1

ACCIDENT LOCATION
Public Highway, Intersection/Related
Public Highway, Non-Intersection
Parking Lot
Private Property or Road

LATITUDE (GPS) Degrees: Minutes: Seconds: LONGITUDE (GPS) Degrees: Minutes: Seconds:

ON Hwy No. and / Street Name Estimated FROM/AT Hwy No. and / Street Name
13 N. 17th St. 16 New York Ave.

House # Fire # Other Agency Space Special Study

Table with columns: Unit Number, Unit Type, Total Number of Occupants, Direction of Travel (Before the Accident)

Speed Limit OPERATOR Last NAME First M.I. ADDRESS Street & Number City & State ZIP Phone Number () Driver's License Number State Exp. Year

Date of Birth Sex Operating as Classified: Class (Mark Only One) Endorse (Mark All That Apply) On Duty Accident

Severity SEAT SAFETY AIRBAG EJECTED TRAPPED/ EXTRICATED Medical Transport

Vehicle Owner Last Name First M.I. Street Address City & State ZIP Phone Number ()

Year of Vehicle Make Model Body Style Color Year of Vehicle Make Model Body Style Color

Vehicle ID Number License Plate Number Plate Type State Exp. Year Policy Holder's Name

Liability Insurance Company Geico Insurance Stat. #

Occupant Unit Number NAME Last First M.I. Date of Birth Sex Severity SEAT SAFETY AIRBAG ADDRESS Street & Number City & State ZIP

Address Same as Operator EJECTED TRAPPED/ EXTRICATED Medical Transport Agency Space

Occupant Unit Number	NAME		M.I.	Date of Birth	Sex	Severity	SEAT Position	SAFETY Equipment	AIRBAG
	Last	First							
1 2 3 4 5 6 7 8 9 10						K N A B C			1 Deployed 2 Non Deployed 3 Not Applicable 4 Unknown
Address Same as Operator	Yes	EJECTED		TRAPPED/EXTRICATED		Medical Transport	Agency Space		
	No	1 Not Applicable 2 Not Ejected	3 Totally Ejected 4 Partially Ejected 5 Unknown	1 Not Applicable 2 Not Trapped	3 Trapped/Extricated 4 Trapped/Not Extricated 5 Unknown	Y N			

Occupant Unit Number	NAME		M.I.	Date of Birth	Sex	Severity	SEAT Position	SAFETY Equipment	AIRBAG
	Last	First							
1 2 3 4 5 6 7 8 9 10						K N A B C			1 Deployed 2 Non Deployed 3 Not Applicable 4 Unknown
Address Same as Operator	Yes	EJECTED		TRAPPED/EXTRICATED		Medical Transport	Agency Space		
	No	1 Not Applicable 2 Not Ejected	3 Totally Ejected 4 Partially Ejected 5 Unknown	1 Not Applicable 2 Not Trapped	3 Trapped/Extricated 4 Trapped/Not Extricated 5 Unknown	Y N			

Type of Accident

0 1 First Harmful Event
Most Harmful Event

Unit Number	Unit Number
2 3 4 5 6 7 8 9 10	1 2 3 4 5 6 7 8 9 10

(select one per vehicle)

Collision With Object Not Fixed

1 Motor Vehicle in Transport	2 Parked Motor Vehicle	3 Deer	4 Pedalcycle	5 Pedestrian	6 Railway Train	7 Other Animal	8 Motor Vehicle in Transport In Other Roadway	9 Other Object (Not Fixed)
------------------------------	------------------------	--------	--------------	--------------	-----------------	----------------	---	----------------------------

Collision With Fixed Object

10 Traffic Sign Post	11 Traffic Signal	12 Utility Pole	13 Lum. Light Support	14 Other Post	15 Tree	16 Mailbox	17 Guardrail Face	18 Guardrail End	19 Median Barrier	20 Bridge Parapet End	21 Bridge/Pier/Abut.	22 Impact Attenuator	23 Overhead Sign Post	24 Bridge Rail	25 Culvert	26 Ditch	27 Curb	28 Embankment	29 Fence	30 Other Fixed Object	31 Unknown
----------------------	-------------------	-----------------	-----------------------	---------------	---------	------------	-------------------	------------------	-------------------	-----------------------	----------------------	----------------------	-----------------------	----------------	------------	----------	---------	---------------	----------	-----------------------	------------

Non-Collision

32 Overturn	33 Fire/Explosion	34 Immersion	35 Jackknife	36 Other Non-Collision
-------------	-------------------	--------------	--------------	------------------------

Driver Condition

Unit Number	Unit Number
2 3 4 5 6 7 8 9 10	1 2 3 4 5 6 7 8 9 10

Driver Factors (Or Pedestrians)

1 Appeared Normal	2 Reduced Alertness	3 Ability Impaired	4 Not Observed
-------------------	---------------------	--------------------	----------------

Presence

5 Neither Alcohol nor Drugs Present	6 Yes—Alcohol Present	7 Yes—Drugs Present	8 Yes—Alcohol & Drugs Present	9 Unknown
-------------------------------------	-----------------------	---------------------	-------------------------------	-----------

Alcohol

AC Value	AC Value		
10 Test Not Given	11 Test Refused	12 Test Given, Alcohol Unknown	13 Test Given, No Alcohol Reported

Drugs

14 Test Not Given	15 Test Refused	16 Test Given, Drugs Unknown	17 Test Given, No Drugs Reported	18 Drugs Reported (Specify Below)	19 Marijuana	20 Cocaine	21 Opiates	22 Amphetamines	23 PCP	24 Other Drug Medication	25 Type Unknown
-------------------	-----------------	------------------------------	----------------------------------	-----------------------------------	--------------	------------	------------	-----------------	--------	--------------------------	-----------------

Pedestrian

Unit # 2 3 4 5 6 7 8 9 10

Location	Action
1 In Crosswalk	1 Walking not Facing Traffic
2 In Roadway	2 Disregarded Signal
3 Not in Roadway	3 Darting into Road
4 On Sidewalk	4 Dark Clothing
	5 Walking Facing Traffic

Manner of Collision

1 No Collision with Motor Vehicle in Transport	2 Rear-end	3 Head On	4 Rear to Rear	5 Angle	6 Sideswipe, Same Direction	7 Sideswipe, Opposite Direction	8 Unknown
--	------------	-----------	----------------	---------	-----------------------------	---------------------------------	-----------

Vehicle Damage

Unit # 2 3 4 5 6 7 8 9 10

Darken Numbered Area(s) of Vehicle Damage

9 None	10 Undercarriage	11 Total (Damage to all Areas)	12 Other	13 Unknown
--------	------------------	--------------------------------	----------	------------

Extent of Damage

1 None	2 Very Minor	3 Moderate	4 Severe	5 Very Severe	6 Unknown
--------	--------------	------------	----------	---------------	-----------

Vehicle Towed Due to Damage: Y
Vehicle Removed By: Friend

Vehicle Damage

Unit # 1 2 3 4 5 6 7 8 9 10

Darken Numbered Area(s) of Vehicle Damage

9 None	10 Undercarriage	11 Total (Damage to all Areas)	12 Other	13 Unknown
--------	------------------	--------------------------------	----------	------------

Extent of Damage

1 None	2 Very Minor	3 Moderate	4 Severe	5 Very Severe	6 Unknown
--------	--------------	------------	----------	---------------	-----------

Vehicle Towed Due to Damage: N
Vehicle Removed By: Gaffney Towing

Fixed Object Struck					PROPERTY OWNER	
Unit	Unit	Unit	Unit	Unit	Last	First
					M.I.	
ADDRESS Street & Number					City & State	
ZIP					Phone Number ()	
Inv. Damage Tag #					Gaffney Towing	



Draw Diagram of Accident & Indicate North with an arrow in the circle.

Pictorial Representation of Narrative

Supplemental Reports Witness Statements Measurements Taken

Skidmarks to Impact
Unit 1 10N Unit 2
FEET

Surface concrete
Type: Stop Sign

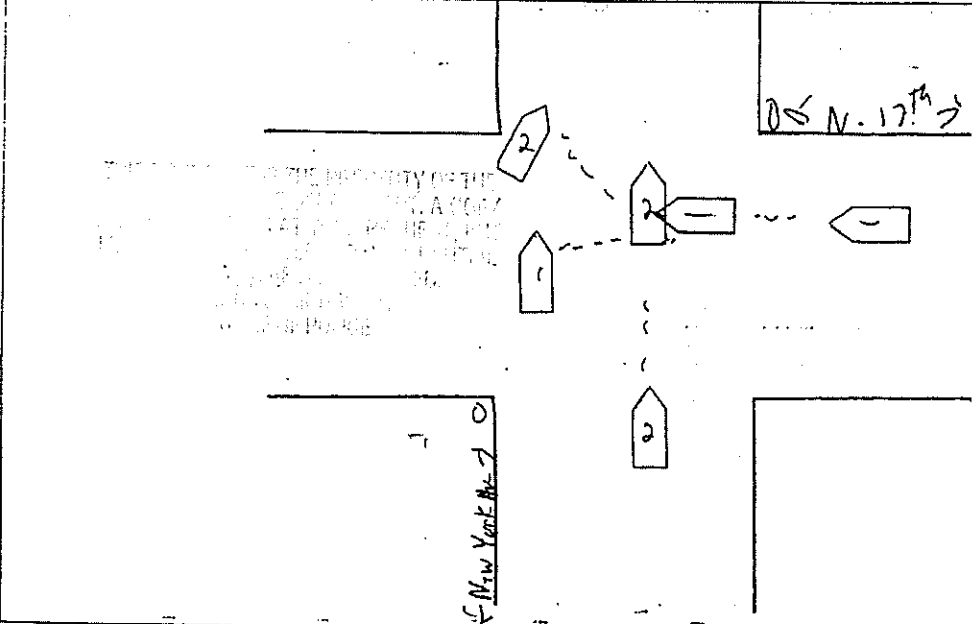

N Operator Unit #1 stated that as he braked, his vehicle
A started hydroplaning on the flooded street. It entered
R the intersection and struck Unit #2. Operator Unit #1
R suffered a bump and soreness to his right knee. Operator
A Unit #2 stated he was WB when Unit #1 went through the
A stop sign and struck his vehicle. Operator Unit #2
T had pain to his right cheek, left thigh, and a headache.
I He was transported to hospital by rescue squad.
V
E

Photos By: 105

What Drivers Were Doing	
Unit Number	Unit Number
<input checked="" type="radio"/> 1	<input type="radio"/> 1
<input type="radio"/> 2	<input type="radio"/> 2
<input type="radio"/> 3	<input type="radio"/> 3
<input checked="" type="radio"/> 4	<input type="radio"/> 4
<input type="radio"/> 5	<input type="radio"/> 5
<input type="radio"/> 6	<input type="radio"/> 6
<input type="radio"/> 7	<input type="radio"/> 7
<input type="radio"/> 8	<input type="radio"/> 8
<input type="radio"/> 9	<input type="radio"/> 9
<input type="radio"/> 10	<input type="radio"/> 10
<input type="radio"/> 11	<input type="radio"/> 11
<input type="radio"/> 12	<input type="radio"/> 12
<input type="radio"/> 13	<input type="radio"/> 13
<input type="radio"/> 14	<input type="radio"/> 14
<input type="radio"/> 15	<input type="radio"/> 15
<input type="radio"/> 16	<input type="radio"/> 16
<input type="radio"/> 17	<input type="radio"/> 17
<input type="radio"/> 18	<input type="radio"/> 18

Traffic Control	
Unit Number	Unit Number
<input checked="" type="radio"/> 1	<input type="radio"/> 1
<input type="radio"/> 2	<input type="radio"/> 2
<input type="radio"/> 3	<input type="radio"/> 3
<input checked="" type="radio"/> 4	<input type="radio"/> 4
<input type="radio"/> 5	<input type="radio"/> 5
<input type="radio"/> 6	<input type="radio"/> 6
<input type="radio"/> 7	<input type="radio"/> 7
<input type="radio"/> 8	<input type="radio"/> 8
<input type="radio"/> 9	<input type="radio"/> 9
<input type="radio"/> 10	<input type="radio"/> 10
<input type="radio"/> 11	<input type="radio"/> 11

WITNESS Last	First	M.I.
NAME 107		
ADDRESS Street & Number	Date of Birth	
108	109	
City & State	Phone	
110	Number 111 ()	

ACCESS CONTROL	112
<input checked="" type="radio"/> No Control (Unlimited Access)	
<input type="radio"/> Full Control (Only Ramp Entry/Exit)	
<input type="radio"/> Partial Control	

ROAD TERRAIN	113
Part A	
<input checked="" type="radio"/> Straight	
<input type="radio"/> Curve	
Part B	
<input checked="" type="radio"/> Level/Flat	
<input type="radio"/> Hill	

LIGHT CONDITION	114
<input checked="" type="radio"/> Daylight	
<input type="radio"/> Dark-Not Lighted	
<input type="radio"/> Dark-Lighted	
<input type="radio"/> Dawn	
<input type="radio"/> Dusk	
<input type="radio"/> Unknown	

TRAFFIC WAY	115
<input checked="" type="radio"/> Not Physically Divided (2-Way Traffic)	
<input type="radio"/> Divided Highway, Median Strip, without Traffic Barrier	
<input type="radio"/> Divided Highway, Median Strip, with Traffic Barrier	
<input type="radio"/> One-Way Traffic	
<input type="radio"/> Parking Lot or Private Property	

ROAD SURFACE CONDITION	116
<input type="radio"/> Dry	
<input checked="" type="radio"/> Wet	
<input type="radio"/> Snow/Slush	
<input type="radio"/> Ice	
<input type="radio"/> Sand, Mud, Dirt, Oil	
<input type="radio"/> Other	
<input type="radio"/> Unknown	

WEATHER	118
<input type="radio"/> Clear	
<input type="radio"/> Cloudy	
<input checked="" type="radio"/> Rain	
<input type="radio"/> Snow	
<input type="radio"/> Sleet, Hail (Freezing Rain or Drizzle)	
<input type="radio"/> Blowing Sand, Soil, Dirt, Snow	
<input type="radio"/> Severe Crosswinds	
<input type="radio"/> Other	
<input type="radio"/> Unknown	

RELATION TO ROADWAY	117
<input checked="" type="radio"/> On Roadway	
<input type="radio"/> Parking Lot or Private Property	
<input type="radio"/> Shoulder (Other than Shoulder within Median or Gore)	
<input type="radio"/> Median (Other than Median within Gore)	
<input type="radio"/> Outside Shoulder-Left	
<input type="radio"/> Outside Shoulder-Right	
<input type="radio"/> Off Roadway-Location Unknown	
<input type="radio"/> On Ramp	

Document Number Override
121

Officer's Opinion of Possible Contributing Circumstances

Driver Factors

Unit Number	Unit Number
1 2 3 4 5 6 7 8 9 10	1 2 3 4 5 6 7 8 9 10
<input type="radio"/> N/A	<input type="radio"/> N/A
1 Exceeding Speed Limit	1
2 Speed too Fast Condition	2
3 Fail to Yield Right of Way	3
4 Inattentive Driving	4
5 Following too Close	5
6 Improper Turn	6
7 Left of Center	7
8 Disregarded Traffic Control	8
9 Improper Overtaking	9
10 Unsafe Backing	10
11 Failure to have Control	11
12 Driver Condition	12
13 Physically Disabled	13
14 Other	14

Vehicle Factors

Unit Number	Unit Number
1 2 3 4 5 6 7 8 9 10	1 2 3 4 5 6 7 8 9 10
<input type="radio"/> N/A	<input type="radio"/> N/A
1 Brake System	1
2 Tires	2
3 Steering System	3
4 Turn Signals	4
5 Head Lamps	5
6 Stop Lamps	6
7 Tail Lamps	7
8 Disabled in Prior Accident	8
9 Other Disabled	9
10 Mirrors	10
11 Suspension System	11
12 Other	12

Highway Factors

Unit Number	Unit Number
1 2 3 4 5 6 7 8 9 10	1 2 3 4 5 6 7 8 9 10
<input type="radio"/> N/A	<input type="radio"/> N/A
1 Snow, Ice or Wet	1
2 Narrow shoulder	2
3 Low Shoulder	3
4 Soft Shoulder	4
5 Loose Gravel	5
6 Rough Pavement	6
7 Debris from Prior Accident	7
8 Other Debris	8
9 Sign Obscured or Missing	9
10 Narrow Bridge	10
11 Construction Zone	11
12 Visibility Obscured	12
13 Other	13

OFFICER INFORMATION

Last	First	M.I.
Schweigl,	Officer	
Law Enforcement Agency Address		
126 Jay St.		
City & State		
127 Manitowoc, WI 54220-4522		
Phone Number		
()		
Agency #	Enforcement Agency	Officer ID #
129 3601	130 Manitowoc P.D.	131 860

Date Notified			Time Notified (Military Time)		Time Arrived (Military Time)		Date of Report		
MONTH	DAY	YEAR	HOUR	MIN.	HOUR	MIN.	MONTH	DAY	YEAR
Jan			1	8	1	5	Jan		
Feb	7	96					Feb	7	96
Mar		0 0, 199 0	0	0	0	0	Mar	0	0, 199 0
Apr		1 1, 2 2	0	1	0	1	Apr		1 1, 2 2
May		3 3, 4 4	2	2	2	2	May		3 3, 4 4
June		5 5, 6 6	3	3	3	3	June		5 5, 6 6
July		7 7, 8 8	4	4	4	4	July		7 7, 8 8
Aug		9 9	5	5	5	5	Aug		9 9
Sept		0 0	6	6	6	6	Sept		0 0
Oct		1 1	7	7	7	7	Oct		1 1
Nov		2 2	8	8	8	8	Nov		2 2
Dec		3 3	9	9	9	9	Dec		3 3

Truck & Bus Accident Information (This Section Must Be Completed for Each Truck or Bus Involved in this Accident.)

When To Use This Section: *Did the accident involve...*

Part A

A truck with at least two axles and six tires? Y N

A truck with a hazardous materials placard? Y N

A bus designed to carry 16 or more persons, including the driver? Y N

STOP! If all the responses to Part A are "NO" do not complete this Truck & Bus Accident Information Section. If there are any "YES" answers, continue to Part B.

Part B

Any person who was fatally injured? Y N

Any injured person requiring transport for immediate medical treatment? Y N

One or more vehicles that had to be towed from the scene as a result of the accident? Y N

One or more vehicles that required repair or were provided assistance before proceeding from scene under own power? Y N

STOP! If all the responses to Part B are "NO" do not continue. If there are any "YES" answers, please complete this Truck & Bus Accident Information Section...

Hazardous Material Information

- Hazardous Material Class Numbers (1-2 digit):
- Hazardous Material "UN" Numbers (4 digit):
- Hazardous Material Placard Displayed? Y N
- Hazardous Cargo was Released? Y N

List the Hazardous Material(s) by name in this load:

List the Name(s) of Released Hazardous Material(s):

Carrier Information

Carrier Identification Numbers

US DOT 140	LC	Source: <input type="checkbox"/> Vehicle Side
ICC MC	IC	<input type="checkbox"/> Shipping Papers
Carrier Address 142		<input type="checkbox"/> Trip Manifest
		<input type="checkbox"/> Driver
		<input type="checkbox"/> Log Book

Interstate Carrier? Y N

Carrier Name 139

Vehicle Information

Gross Vehicle Weight Rating 144 LBS Total # of Axles 144

Vehicle Configuration

1 Bus	2 Single unit truck 3+ axles	3 Truck Tractor	4 Tractor Doubles	5 Unknown Heavy Truck
6 Single unit truck, 2 axles, 6 tires	7 Truck Trailer	8 Tractor Semi-Trailer	9 Tractor Triples	10 Log Truck

SEQUENCE OF EVENTS FOR THIS VEHICLE

Mark a total of one to four events in the order that they occurred

1 2 3 4	1 Ran off Road	1 2 3 4	1 Collision involving motor vehicle in transp.
1 2 3 4	2 Jackknife	1 2 3 4	2 Collision involving parked motor vehicle
1 2 3 4	3 Overturn (Rollover)	1 2 3 4	3 Collision involving train
1 2 3 4	4 Downhill Runaway	1 2 3 4	4 Collision involving pedalcycle
1 2 3 4	5 Cargo Loss or Shift	1 2 3 4	5 Collision involving animal
1 2 3 4	6 Explosion or Fire	1 2 3 4	6 Collision involving fixed object
1 2 3 4	7 Separation of Units	1 2 3 4	7 Collision involving other object
1 2 3 4	8 Collision involving pedestrian	1 2 3 4	8 Other

Cargo Body Type

1 Bus	6 Concrete Mixer
2 Van Enclosed box	7 Auto Transporter
3 Cargo Tank	8 Garbage Refuse
4 Flatbed	9 Other
5 Dump	10 Log Truck

Mark "Reiter" by NCS MMS9710B:321 A4100
Printed in U.S.A.

INCIDENT HISTORY DETAIL: X042590164

INITIATE: 09:50:16 09/15/04 CALL NUMBER: X0164
ENTRY: 09:51:24 CURRENT STATUS: CLOSED
DISPATCH: PRIMARY UNIT: 141-204
ONSCENE: CASE NUMBER: SO0400008302
CLOSE: 09:51:24 DISPOSITION:

LOCATION: CR/SILVER CREEK RD N ,MTW (CR/SILVER CREEK RD N)
LOCATION COMMENTS:
DAREA: MTSO
BEAT: UNK MAP PAGE: FIE TYPE: PINFO H&R INFO
RD: 14012 PRIORITY: 5

09:51:24 DW13 ENTRY TEXT:ANONYMOUS CALLER PROVIDED INFO THAT THEY BELIEVE
A VEHICLE OWNED BY MICHAEL WAUTELET OF KEWAUNEE MAY
HAVE BEEN INVOLVED IN THE S99-00242 H&R \COMP:ANONYMO-
US
09:51:24 DW13 CLOSE CLOSED EVENT ENTERED
09:51:30 DW13 CASE SO0400008302 Assigned
OPERATOR ASSIGNMENTS: DW13 S592

MANTOWOC COUNTY SHERIFF'S DEPARTMENT INCIDENT

CASE No. S04 - 08302

MANITOWOC COUNTY SHERIFF'S DEPARTMENT
FOLLOW-UP REPORT

Page: 2

CASE NUMBER: 504-08302 CLASSIFICATION: _____

INCIDENT: _____

DATE AND TIME: _____

REPORT CONTINUED:

V	HOCHSTETLER ¹⁴⁶⁰³⁴ RICHARD	D	05/13/81 Deceased	
O	WAUTELET ²²¹²⁸⁸ MICHAEL	K	██████████ 2nd St, Kewaunee 54216	██████████
O	WAUTELET ¹³⁶¹²⁶ CATHERINE	J	██████████ 2nd St, Kewaunee 54216	██████████
O	WAUTELET ²²¹²⁸⁹ KEVIN	M	██████████ Deceased (Suicide--03/20/04)	
O	WAUTELET ¹⁶⁹⁶⁰³ MATTHEW	J	██████████ 2nd St, Kewaunee 54216	██████████

09/12/04: An anonymous caller gave MTSO the following information. He would not say why he feels this way, but he thinks a 1991 Chevy 1/2 ton pickup truck, white in color, owned by MICHAEL WAUTELET of Kewaunee may be the truck from the RICHARD HOCHSTETLER hit & run fatality accident (see incident S99-00242). He said MICHAEL and CATHERINE WAUTELET recently bought a new truck and may have either traded this one in or given it to their son. If they gave it to their son, it would still be registered in their names. The caller would not provide a phone number to call him back at but stated he would call me, D.I. M. Bushman, on 09/13/04 or 09/14/04.

The vehicle that the anonymous caller is referring to is actually a 1992 Chevy truck, white in color, bearing a VIN of ██████████

I, D.I. M. Bushman, did not receive a phone call reference this compliant.

A 1991 Chevy truck would not match the suspect vehicle in the HOCHSTETLER case.

A call was placed to Vehicle Records at DOT, phone of ██████████ I spoke with JOE and requested that a check be made of all vehicles listing to MICHAEL, CATHERINE, and KEVIN WAUTELET for the years of 1997, 1998, and 1999.

Within an hour, I received a call-back and the following vehicle information listed below was obtained (also, a fourth party by the name of MATTHEW WAUTELET with the same address was noted):

- MICHAEL & CATHERINE
 - 1991 Dodge auto
 - 1985 Dodge auto
 - 1996 Chevy auto
 - 1992 Chevy truck
- KEVIN
 - None listed
- MATTHEW
 - 1991 Chevy auto
 - 1998 Motorcycle

Wautelet, Michael K. [REDACTED] [REDACTED] 2nd St., Kewaunee, WI 54216 [REDACTED]
Wautelet, Catherine J. [REDACTED] Same
Wautelet, Kevin M. [REDACTED] Same
Wautelet, Matthew

09/14/04 An anonymous caller gave MTSO the following information. He wouldn't say why he feels this way, but thinks a 91 white Chev. 1/2 ton pick-up truck owned by Michael Wautelet of Kewaunee may be the truck from the Hochstetler fatality. He said the Wautelet's recently bought a new truck and may either traded this one in or given it to their son. If they gave it to their son it would still be registered in their names. Caller would not provide a phone number to call back on but stated they will call DI Bushman 9-13 or 9-14. The vehicle the anonymous caller is referring to is actually a white 92 Chev. Truck with vin number [REDACTED]

I, DI Bushman, did not receive a phone call reference this complaint. A 91 Chev truck would not match the suspect vehicle in the Hochstetler case. A call was placed to Vehicle records at the DOT [REDACTED] and I spoke with Joe. A request was made to check all vehicles listing to Michael, Catherine, and Kevin in the year 1997, 1998, and 1999. Within an hour I received a call back and the following vehicle information listed below was obtained. Also a fourth party (Matthew) with the same address and last name was noted.

Michael & Catherine: 91 Dodge-Auto
85 Dodge-Auto
96 Chev-Auto
92 Chev-Truck

Kevin: None

Matthew: 91 Chev-Auto
98 Motorcycle

STATEMENT

STATEMENT OF:

INCIDENT#

NAME:

PAGE

OF

BIRTH DATE:

AGE:

DATE:

ADDRESS:

TIME:

CITY:

STATE:

ZIP:

PHONE:

IF JUVENILE:

FATHER:

MOTHER:

WITNESS:

SIGNATURE:

WITNESS:

TIME:



MANITOWOC COUNTY SHERIFF'S DEPARTMENT

South 9th Street
Manitowoc, Wisconsin 54220

Phone [redacted] Fax [redacted]



Date 09-01-04

TO: Postmaster
RE: Address Information Request

Please furnish this agency with the new address, if available, for the following individual(s) to verify whether or not the address given below is one at which mail for this individual is currently being delivered. If the following address is a post office box, please furnish the street address as recorded on the boxholder's application form.

I certify that the address information for this individual(s) is required for the performance of this agency's official duties.

DETECTIVE Dan [redacted] #206
Signature/Title of Agency Official

Name: GARY J RUELLE Name: _____

Last Known Address: [redacted] CHICAGO ST. Last Known Address: _____

MANITOWOC WI 54220

NEW ADDRESS: [redacted] PARKWAY CT. NEW ADDRESS: _____

TWO RIVERS, WI 54241

- Mail is delivered to address given
- Not known at address given
- Moved, left no forwarding address
- No such address
- Other (specify):

INCIDENT HISTORY DETAIL: X041830130

INITIATE: 08:39:38 07/01/04 CALL NUMBER: X0130
ENTRY: 08:43:25 CURRENT STATUS: CLOSED
DISPATCH: PRIMARY UNIT:
ONSCENE: CASE NUMBER: MT0400005727 and more
CLOSE: 08:43:25 DISPOSITION: 3004-5997

LOCATION: [REDACTED] S 9 ST ,MTW (MANITOWOC COUNTY)

LOCATION COMMENTS:

DAREA: MTPD

BEAT: M04

RD: 52067

TYPE: PINFO HIT AND RUN INFO
PRIORITY: 5

5718

08:43:25 DW01 ENTRY TEXT:RECVD INFORMATION REF HIT AND RUN FATAL IN
MANITOWOC COUNTY SEVERAL YEARS AGO POSIBLE S99-242
COMP:GBPD OFFICER BOURDELAIS

08:43:25 DW01 CASE MT0400005727

08:43:25 DW01 CLOSE CLOSED EVENT ENTERED

08:43:39 DW01 CASE S00400005997 Assigned OVR

OPERATOR ASSIGNMENTS: DW01 D928 SALES, LAURIE

MANITOWOC COUNTY SHERIFF'S DEPARTMENT INCIDENT

CASE No. S04 -

0599

- 1 Unfounded
- 2 PNL
- 3 Other
- 4 Cleared
- 5. Except Cleared

- 1 Adult
- 2. Juvenile
- 3. Unknown

File Approval: LUKAS
Date: 8/5/04

MANITOWOC COUNTY SHERIFF'S DEPARTMENT
FOLLOW-UP REPORT

Page: 2

CASE NUMBER: 504-05997 CLASSIFICATION: _____

INCIDENT: _____

DATE AND TIME: _____

REPORT CONTINUED:

V	HOCHSTETLER ¹⁴⁰³⁴ RICHARD	D	05/13/81
S	MANDERS ²¹⁹⁶⁶⁴ STEVEN	M	██████████ ██████████ Grant St, DePere 54115
O	██████████ ²¹⁹⁶⁶⁵ ██████████	█	██████████ ██████████ ██████████

06/25/04: I, Det. Remiker, received information from Lt. Lenk reference information that GBPD Officer Bourdelais may have reference a hit & run fatal accident in Manitowoc Co. I received the information that Officer Bourdelais spoke with a male subject about a hit & run fatal accident in Manitowoc Co. approx. 5-7 years ago. Officer Bourdelais may have some information on who committed the act and what happened to the vehicle. I received information that the vehicle that was involved in the fatal hit & run accident was a Chevrolet pickup truck. I also received some phone numbers to make contact with Officer Bourdelais.

06/25/04: I attempted contact with Officer Bourdelais' cell phone. I left a voice mail on the recording.

06/28/04 @ 1420 Hrs.: I again attempted contact with Officer Bourdelais. I received the voice mail on his cell phone. I previously was informed that Officer Bourdelais works the shift from 1900-0330 hours.

06/28/04 @ 2000 Hrs.: I made contact with GBPD Dispatch. I was advised that Officer Bourdelais was on his days off.

06/29/04 @ 1516 Hrs.: I received 2 voice mail messages from Officer Bourdelais. Officer Bourdelais stated he has a male informant by the name of ██████████ who lives in the City of Green Bay who provided information about a possible hit & run fatal accident which occurred approx. 5-7 years ago. Officer Bourdelais identified the male subject involved with the possible accident as STEVEN MANDERS who lives at a Grant St address in the City of DePere. Officer Bourdelais provided the following information about what information he received.

Officer Bourdelais stated the vehicle was a 1978 Chevrolet pickup truck which was light gray and blue in color. Officer Bourdelais stated the front grill was smashed and that there was flesh and hair located on the truck and/or grill area. Officer Bourdelais stated ██████████ was told that MANDERS claimed to have hit a deer. He parked the vehicle at an uncle's residence for approx. 3 years. Officer Bourdelais stated the vehicle was then taken to a location described as LASH STEEL & RECYCLING in Brown Co. Officer Bourdelais stated the information he received indicated that this accident occurred just outside the Village of Denmark. Officer Bourdelais stated he believed the accident happened on a "main drive" just inside Manitowoc Co. Officer Bourdelais stated MANDERS was living across from a cheese factory in Denmark when the accident occurred. Officer Bourdelais stated ██████████ is an informant of his and provided this information that ██████████ received directly from

MANITOWOC COUNTY SHERIFF'S DEPARTMENT
FOLLOW-UP REPORT

Page: 3

CASE NUMBER: 504-05997 CLASSIFICATION: _____

INCIDENT: _____

DATE AND TIME: _____

REPORT CONTINUED:

location in Calumet Co. but has since been directed to a location just outside of Denmark, inside Manitowoc Co.

Based on the information I received from Officer Bourdelais, there are several inconsistencies in the unsolved fatal hit & run accident involving RICHARD HOCHSTETLER (see incident S99-00242). The vehicle attempting to be located in the hit & run accident is a 1985-1989 truck. The unsolved fatal hit & run accident in Manitowoc Co. is not in the vicinity of the Denmark area, but there are some consistencies reference the time frame when the accident occurred.

I will conduct some further follow-up and attempt to make contact with MANDERS reference this incident. Further follow-up is forthcoming. DERemiker /bjc

- O KOZLOSKI 149889 PAUL B [REDACTED] Locust Rd, Little Suamico [REDACTED]
- O LASH STEEL & RECYCLING 220398 [REDACTED] Riverview Dr, Green Bay [REDACTED]

I, Det. Remiker, made contact with PAUL KOZLOSKI at LASH STEEL & RECYCLING in the City of Green Bay. KOZLOSKI stated he would check their records and determine the year of the vehicle which was turned over to the business for disposal.

I received a call-back which indicated that the vehicle which was turned over for disposal was definitely a 1978 Chevrolet pickup truck. Based on the information that was provided on the documents for the disposal records, there was no indication of any damage to the front portion of the vehicle. The vehicle has since been disposed of.

I have made several attempts to make contact with STEVEN MANDERS reference this complaint. I received information previously by Officer Bourdelais that MANDERS resides at various hotels within the City of Green Bay. MANDERS does not have a permanent residence where he can be contacted at.

Based on the information that I received from the GBPD officer and LASH STEEL & RECYCLING, all indications are that the information received is not consistent with the information from the HOCHSTETLER hit & run incident. The vehicle that was allegedly involved in the accident was prior to the time frame identified as the vehicle used in the accident. With the exception of the vague time frame when the accident occurred, there is no additional information that would be consistent with the unsolved hit & run accident.

Unless I receive further information on the whereabouts of STEVEN MANDERS, I believe that no further follow-up is necessary and this incident can be closed. DERemiker /bjc

MJD

INCIDENT HISTORY DETAIL: X040940190

INITIATE: 12:57:21 04/03/04 CALL NUMBER: X0190
ENTRY: 12:57:58 CURRENT STATUS: CLOSED
DISPATCH: 12:58:12 PRIMARY UNIT: S278
ONSCENE: CASE NUMBER: SO0400003213
CLOSE: 12:58:14 DISPOSITION: RPT

LOCATION: CR/SILVER CREEK RD N ,MTW (CR/SILVER CREEK RD N)

LOCATION COMMENTS:

DAREA: MTSO
BEAT: S03 MAP PAGE: FIE TYPE: PINFO FOLLOW UP
RD: 14012 PRIORITY: 5
PRIORS

12:57:58 DW01 ENTRY TEXT:RE; S99-0242 REC REQ FROM S278 TO START INC
COMP:MTSO
12:57:58 DW01 PRIOR XP T 02/23/04 @ 19:27:02 (7 MORE)
12:58:06 DW01 CASE SO0400003213 Assigned
12:58:12 DW01 DISPATCH S278
12:58:12 DW01 ID S278 <S278>REMIKER, DAVID
12:58:14 DW01 CLEAR S278 RPT
12:58:14 DW01 CLOSE S278 RPT

OPERATOR ASSIGNMENTS: DW01 D921 JEBAVY, PAM

MANTOWOC COUNTY SHERIFF'S DEPARTMENT INCIDENT

CASE No. S04 - 03213

- 1 Unfounded
- 2 PNL
- 3 Other
- 4 Cleared
- 5 Except Cleared

- 1 Adult
- 2 Juvenile
- 3 Unknown
- File Approval
- Date 4-7-04

[Handwritten signature]

MANITOWOC COUNTY SHERIFF'S DEPARTMENT
FOLLOW-UP REPORT

Page: 2

CASE NUMBER: 504-03213 CLASSIFICATION: _____

INCIDENT: _____

DATE AND TIME: _____

REPORT CONTINUED:

V HOCHSTETLER RICHARD D ¹⁴⁶⁰³⁴ 05/13/81

03/30/04 @ 1130 Hrs.: I, Det. Remiker, went to a location just south of [REDACTED] CTH CR, Manitowoc. I received information previously by Sgt. A. Colborn that there was a vehicle parked on the property which may be a suspect vehicle in the fatal hit & run accident from 1999 (incident S99-00242).

I walked the property and observed the vehicle which was severely damaged. The vehicle did not contain an engine. Based on my observations, it looked as though the vehicle had been parked at this location for several years. The vehicle contained a 13-digit VIN, that being [REDACTED]. Dispatch ran this VIN; however, it came back "Not on File." I was advised that the 13-digit VIN on this vehicle would indicate that the vehicle is a pre-1980s model. The vehicle also had a front end grill which contained a single, round headlight assembly.

All indications are that this would not be a suspect vehicle for the fatal hit & run accident on CTH CR in 1999. All indications are that the vehicle is a junked vehicle that has been parked at this location for numerous years.

No further follow-up is needed. DERemiker /bjc

INCIDENT HISTORY DETAIL: X041910159

INITIATE: 11:10:26 07/09/04 CALL NUMBER: X0159
ENTRY: 11:13:35 CURRENT STATUS: CLOSED
DISPATCH: 13:46:19 PRIMARY UNIT: S141
ONSCENE: 13:46:19 CASE NUMBER: SO0400006231
CLOSE: 13:46:26 DISPOSITION: HBO

LOCATION: 1025 S 9 ST ,MTW (MANITOWOC COUNTY)

LOCATION COMMENTS:

DAREA: MTSO
BEAT: UNK TYPE: SUSP 5718 Info SUSP VEHICLE
RD: 52067 PRIORITY: 2
PRIORS

11:13:35 DW01 ENTRY TEXT:2970F GMC TRUCK WITH CAP WAS DRIVING ERRATIC ON
147 BY THE SOD FARM. THERE IS DAMAGE TOT HE FRONT END.
TRUCK IS NOW PARKED NEAR THE BAR AT 141 SPEEDWAY.
SPEEDWAY 141 COMPL THINKS THIS MAY BE THE TRUCK FROM
THE HIT AND RUN \COMP:GEORGE MOTT \LOC: [REDACTED] ALBERT DR
PH: [REDACTED]

11:13:35 DW01 PRIOR XP ATTSUI TODAY @ 06:31:55 (98 MORE)
11:13:54 DW01 SUPP TEXT:SEVERAL YEARS AGO. HE IS WILLING TO SPEAK WITH AN
OFFICER AND WOULD LIKE TO KNOW THE OUTCOME

11:21:45 DW01 HOLD
11:31:53 DW01 HOLD
13:45:42 DW03 CASE SO0400006231 Assigned
13:46:19 DW01 DISP-ONS S141
13:46:19 DW01 ID S141 <S141>BUSHMAN, MICHAEL
13:46:26 DW01 CLEAR S141 HBO
13:46:26 DW01 CLOSE S141 HBO

OPERATOR ASSIGNMENTS: DW01 D928 SALES, LAURIE
DW03 D932 HEARLEY, MICHELLE

1 Unfounded
2. PNL
3 Other
4 Cleared
5. Except Cleared
1 Adult
2. Juvenile
3. Unknown
File Approval [Signature]
Date 7/13/04

MANITOWOC COUNTY SHERIFF'S DEPARTMENT INCIDENT

CASE No. S04 - 06231

MANITOWOC COUNTY SHERIFF'S DEPARTMENT
FOLLOW-UP REPORT

Page: 2

CASE NUMBER: 504-010231 CLASSIFICATION: _____

INCIDENT: _____

DATE AND TIME: _____

REPORT CONTINUED:

V	HOCHSTETLER	¹¹¹⁶⁰³⁴ RICHARD	D	05/13/81		
W	MOTT	²²⁰³⁵⁰ GEORGE			Albert Dr, Manitowoc	
O	141 SPEEDWAY	⁵¹⁴⁷			CTH R, Whitelaw	
O	ROZUM	⁹⁰⁷⁷ RONALD	G		Polifka Rd, Whitelaw	

07/09/04 @ 1130 Hrs.: I, D.I. M. Bushman, was handed this complaint reference the possibility of a RICHARD HOCHSTETLER hit & run fatal accident vehicle. I attempted several contacts with the complainant, GEORGE MOTT, from 1130-1225 hours. This resulted with no one answering at the phone number which MOTT provided.

I attempted contact with the vehicle by taking an unmarked unit and going to 141 SPEEDWAY. No vehicle matching the description provided was located.

According to the 10-28 attached to this complaint, the vehicle comes back to RONALD ROZUM from Polifka Rd, Whitelaw. I completed a drive-by of the residence, observing a 1988 GMC truck with front end damage parked in plain view in the driveway. It was obvious from a distance that the vehicle parked in the driveway was not involved in the HOCHSTETLER incident because of the design of the front end of the truck. I took a closer look at the vehicle. I matched the 297F Farm RP which was provided by the complainant. This is not the vehicle involved in the HOCHSTETLER incident.

The grill, headlight assemblies, and model do not match those which we are looking for.
MJBushman /bjc

INCIDENT HISTORY DETAIL: X040710198

INITIATE: 11:20:57 03/11/04 CALL NUMBER: X0198
ENTRY: 11:21:50 CURRENT STATUS: CLOSED
DISPATCH: 11:21:58 PRIMARY UNIT: S278
ONSCENE: CASE NUMBER: SO0400002488
CLOSE: 11:22:09 DISPOSITION: RPT

LOCATION: [REDACTED] NORTHEIM RD ,NEW (CARSTENS LAKE & CTY TK C)
LOCATION COMMENTS:
DAREA: MTSO
BEAT: S03 TYPE: PINFO HOCKSTETTLER
RD: 14023 PRIORITY: 5
PRIORS

5710

11:21:50 DW01 ENTRY TEXT:REC RQ FROM S278 TO START INC RE; INFO/HOCKSTETT-
LER INC \COMP:ANONYMOUS
11:21:50 DW01 PRIOR XP PRO 07/08/03 @ 18:51:45 (1 MORE)
11:21:58 DW01 DISPATCH S278
11:21:58 DW01 ID S278 <S278>REMIKER, DAVID
11:22:01 DW01 CASE SO0400002488 Assigned
11:22:09 DW01 CLEAR S278 RPT
11:22:09 DW01 CLOSE S278 RPT

OPERATOR ASSIGNMENTS: DW01 D921 XXX

MANTOWOC COUNTY SHERIFF'S DEPARTMENT INCIDENT

CASE No. S04 -

02488

- 1 Unfounded
- 2. PNL
- 3. Other
- 4 Cleared
- 5. Except Cleared
- 1 Adult
- 2. Juvenile
- 3. Unknown
- File Approval WHD
- Date 3/15/04

MANITOWOC COUNTY SHERIFF'S DEPARTMENT
FOLLOW-UP REPORT

Page: 2

CASE NUMBER: 504-02488 CLASSIFICATION: _____

INCIDENT: _____

DATE AND TIME: _____

REPORT CONTINUED:

V HOCHSTETLER ¹⁴⁶⁰³⁴ RICHARD D 05/13/81
O KRAEMER (24281) SCOTT P [REDACTED] [REDACTED] S 23rd St #1016, Manitowoc [REDACTED]

03/10/04 @ 1815 Hrs.: I, Det. Remiker, received information from a male subject who wished to remain anonymous. The male subject stated he had some information reference the fatal hit & run accident on CTH CR (incident S99-00242). The male subject stated he observed an older model Chevy Suburban parked in a yard on Northeim Rd, just south of Carstens Lake Rd. The informant stated he looked at the vehicle and he believed there was extensive front end damage and repair done on the Suburban. The informant stated the vehicle is parked in a yard with a "For Sale" sign displayed and he did not observe any RPs.

03/11/04: I went to Northeim Rd, south of Carstens Lake Rd. I observed a gray-colored Chevy Suburban parked in the yard at [REDACTED] Northeim Rd. Upon visual inspection of the Suburban, I noticed there was a WI RP displayed on the rear of the vehicle, that being WI RP 957ARP. I attempted to obtain a VIN from the vehicle but was unable to locate one. I observed the front grill area of the vehicle. It looked like repairs had been done to it which included a new front grill, and the front headlight assembly was a single headlight which was round in shape. The vehicle was a Custom Deluxe 10 Chevrolet Suburban which also had some parking stickers on it from the State of TX.

I ran a registration check on the displayed RP which came back on a 1974 Chevrolet truck registered to SCOTT KRAEMER from the City of Manitowoc. Investigators are looking for a 1985-1989 Chevrolet vehicle with a single headlight assembly. This vehicle is several years older than the suspect vehicle.

I met with Inspector R. Hermann who agreed to go to the location where the Suburban was to verify that it was in fact a 1974 model. Without obtaining a VIN, it is difficult to determine if the vehicle is in fact a 1974 model. Inspector Hermann and I went to Northeim Rd and looked at the vehicle. Inspector Hermann verified that the vehicle is in fact an early 1970s model Chevrolet Suburban and does not fall within the 1985-1989 range of the vehicle which is being attempted to be located.

Based on my investigation and the information provided by Inspector Hermann, it is clear that the vehicle parked on Northeim Rd is not a suspect vehicle in the fatal hit & run traffic accident in 1999.

This incident can be closed. DERemiker /bjc

INCIDENT HISTORY DETAIL: X040540230

INITIATE: 14:24:15 02/23/04 CALL NUMBER: X0230
ENTRY: 14:26:05 CURRENT STATUS: CLOSED
DISPATCH: PRIMARY UNIT:
ONSCENE: CASE NUMBER: SO0400001947
CLOSE: 14:26:05 DISPOSITION:

LOCATION: [REDACTED] 16 ST ,TR (UNIMART AMOCO)

LOCATION COMMENTS:

DAREA: MTSO

BEAT: UNK

RD: 1044

5718
TYPE: PINFO H&R FOLLOW UP
PRIORITY: 5

14:26:05 DW13 ENTRY TEXT:COMPLAINANT OBSERVED A WHITE VAN WITH RED PIN STRIPE WITH LICENSED APPLIED FOR REGISTRATION #AC1892 HAS CARBOARD IN GRILL AND NO FRONT PLATE WHICH COULD POSSIBLY BE RELATED TO S99-00242 \COMP:ANONYMOUS
14:26:05 DW13 CLOSE CLOSED EVENT ENTERED
14:26:11 DW13 CASE SO0400001947 Assigned

OPERATOR ASSIGNMENTS: DW13 S592

MANITOWOC COUNTY SHERIFF'S DEPARTMENT INCIDENT

CASE No. S04 -

01947

- 1 Unfounded
- 2. PNL
- ③ Other
- 4 Cleared
- 5. Except Cleared

- 1 Adult
- 2. Juvenile
- 3. Unknown

File Approval LO/12/15
Date 3/4/04

writing for callback from Budget Auto!
When info is obtained, return to DI
Bushman:

[REDACTED] - [REDACTED] - [REDACTED]
DOT

AC 1892

issued by → Budget Auto - Tim Smith
Sheb., WI

[REDACTED] - [REDACTED] - [REDACTED]

owner → Dodge Cargo van
Hiram Rosales Andrade
Sheridan Av #F8, Sheboygan 53081

MANITOWOC COUNTY SHERIFF'S DEPARTMENT
FOLLOW-UP REPORT

Page: 2

CASE NUMBER: 504-01947 CLASSIFICATION: _____

INCIDENT: _____

DATE AND TIME: _____

REPORT CONTINUED:

V	HOCHSTETLER	RICHARD	D	05/13/81	146034	
O	BUDGET AUTO (TIM SMITH)	217738				█████ Pennsylvania Ave, Sheboygan 53081
O	ROSALES ANDRADE	HIRAM	217739			█████ Sheridan Ave #F8, Sheboygan 53081

MTSO received an anonymous complaint of a vehicle seen at the UNI-MART located at █████ 16th St, Two Rivers, on 02/20/04, which matched the RICHARD HOCHSTETLER suspect hit & run vehicle. The suspect vehicle was described as a white van with a red pin stripe and "License Applied For Registration" on the rear of AC1892. There was cardboard in the grill, and there was no front RP. The caller felt this could be related to incident S99-00242.

Dispatch was able to obtain registration number AC1892 which was issued to BUDGET AUTO of █████ Pennsylvania Ave, Sheboygan.

Contact was made with TIM SMITH, a sales person at BUDGET AUTO. SMITH advised that the vehicle we are questioning is a Dodge cargo van, white in color. He was unsure if there was a red pin stripe. It may have been added since the vehicle was sold. SMITH advised there was cardboard in the grill because the current owner was having trouble with heating the vehicle. The current owner is HIRAM ROSALES ANDRADE of █████ Sheridan Ave #F8, Sheboygan.

Dodge cargo vans do not fit the description of the suspect vehicle we are looking for.
MJBushman /bjc

INCIDENT HISTORY DETAIL: X040330219

INITIATE: 13:01:18 02/02/04 CALL NUMBER: X0219
ENTRY: 13:04:23 CURRENT STATUS: CLOSED
DISPATCH: PRIMARY UNIT:
ONSCENE: CASE NUMBER: SO0400001128
CLOSE: 13:04:23 DISPOSITION:

LOCATION: [REDACTED] S 24 ST ,MTW (SHADY & DIVISION)
LOCATION COMMENTS:
DAREA: MTSO
BEAT: UNK TYPE: ACCHR H&R FOLLOWUP
RD: 52049 PRIORITY: 3

599-00242

13:04:23 DW13 ENTRY TEXT:COMPLAINANT PURCHASED A 1986 CHEVY VAN APPROX 6 MONTHS AGO WITH WIS RP #AN43711 WHICH MATCHES THE DESCRIPTION OF THE SUSPECT VEHICLE FOR HOCHSTETTLER FATALITY. DEPUTY SIDERS WAS ASSIGNED FOR FOLLOWUP. COMP:ADAM J HUSS \LOC:[REDACTED] S 24TH ST., MANITOWOC WI 54220 \PH:[REDACTED]
13:04:23 DW13 CLOSE CLOSED EVENT ENTERED
13:04:28 DW13 CASE SO0400001128 Assigned

420
432

OPERATOR ASSIGNMENTS: DW13 S592

MANITOWOC COUNTY SHERIFF'S DEPARTMENT INCIDENT

CASE No. S04 - 01128

- 1 Unfounded
- 2. PNL
- 3. Other
- 4 Cleared
- 5. Except Cleared

i Adult
2. Juvenile
3. Unknown
File Approval *WAB*
Date 2/13/04

MANITOWOC COUNTY SHERIFF'S DEPARTMENT
FOLLOW-UP REPORT

Page: 2

CASE NUMBER: 504-01128 CLASSIFICATION: _____

INCIDENT: _____

DATE AND TIME: _____

REPORT CONTINUED: _____

02/02/04 @ 1304 hrs. Deputy Siders received information from DI Bushman reference a male subject who had purchased a 1986 Chev van approx. six months ago with Wi RP of AN43711. Vehicle would match a description of a suspect vehicle used in the HOCHSTETLER hit and run fatality (homicide). He wanted to have deputies look at the vehicle to make sure this was not the vehicle used in the hit and run fatality.

I, Deputy Sider along with Sgt. Colborn, did respond to [REDACTED] S 24th St, Manitowoc. While at the residence, Deputy Sider and Sgt. Colborn did look at the vehicle. This was a 1986 Chev van, blue in color, the grill on this vehicle did not match the grill that was used in the hit and run fatality. The grill had the dual headlight pattern, we were looking for the head lamp over parking brake lamp grill. Also the damage to this grill was very minor, there was only one piece of the grill missing, this would be the top upper piece next to the hood. At that time we determined this was not the vehicle used in the hit and run fatality.

After leaving the residence, DI Bushman was contacted immediately and informed of the findings of this vehicle. No further law enforcement action taken. D. Siders /cb

INCIDENT HISTORY DETAIL: X040230111

INITIATE: 08:26:14 01/23/04 CALL NUMBER: X0111
ENTRY: 08:28:45 CURRENT STATUS: CLOSED
DISPATCH: PRIMARY UNIT:
ONSCENE: CASE NUMBER: SO0400000795
CLOSE: 08:28:45 DISPOSITION:

LOCATION: [REDACTED] MIRRO DR ,MTW (RONCALLI HIGH SCHOOL)

LOCATION COMMENTS:

DAREA: MTSO
BEAT: UNK TYPE: ACCHR S99-00242
RD: 52141 PRIORITY: 3

08:28:45 DW13 ENTRY TEXT:COMPL SAW HOCKSTEDLER INC ON TV ON ANNIV DATE AND
WANTED TO REPORT AN OLD PICKUP MATCHING THE
DESCRIPTION OWNED BY A JANITOR, WILLIAM KRAEMER,
PARKED IN AN OUTBUILDING AT RONCALLI. E GLAESER
ASSIGNED. \COMP:ANNOYMOUS

08:28:45 DW13 CLOSE CLOSED EVENT ENTERED
08:28:51 DW13 CASE SO0400000795 Assigned

OPERATOR ASSIGNMENTS: DW13 S597

204 410
209 403
141
184

MANTOWOC COUNTY SHERIFF'S DEPARTMENT INCIDENT

CASE No. S04 - 00795

- 1. Unfounded
- 2. PNL
- 3. Other
- 4. Cleared
- 5. Except Cleared

- 1. Adult
- 2. Juvenile
- 3. Unknown
- File Approval
- Date

[Handwritten signature]

MANITOWOC COUNTY SHERIFF'S DEPARTMENT
FOLLOW-UP REPORT

Page: 2

CASE NUMBER: 504-00795 CLASSIFICATION: _____

INCIDENT: _____

DATE AND TIME: _____

REPORT CONTINUED:

V	HOCHSTETLER ¹⁴⁶⁰³⁴ RICHARD	D	05/13/81	[REDACTED]
O	RONCALLI HIGH SCHOOL ¹²⁸⁰⁴		[REDACTED] Mirro Dr, Manitowoc	[REDACTED]
O	KRAEMER ⁴⁵⁶⁰ WILLIAM	M	[REDACTED] S 26th St, Manitowoc	[REDACTED]
O	KRAEMER ¹⁵⁵²⁶⁰ LUKE	E	[REDACTED] S 26th St, Manitowoc	[REDACTED]

01/12/04: I, D.I. M. Bushman, received a phone call from [REDACTED] who wished to remain anonymous. [REDACTED] wanted to report that shortly after the RICHARD HOCHSTETLER incident on 01/10/99, a Chevrolet pickup truck was parked in one of the outbuildings behind RONCALLI HIGH SCHOOL. The vehicle was owned by a janitor, WILLIAM KRAEMER. The truck remained in the garage for an extended period of time. [REDACTED] felt this truck matched the description which was given of the suspect vehicle in the HOCHSTETLER accident. No other information as far as color, year, or whether there was damage on the vehicle was given. [REDACTED] never saw the front of the vehicle; however, they thought it was suspicious because it was parked in the garage. [REDACTED] had no idea if the vehicle was still there or if it had been moved.

Contact was made with DOT, the Vehicle Records Division, phone of [REDACTED]. I explained to the representative what I was looking for as I have obtained information in the past in this fashion. They did a search for all vehicles which may match the description of the suspect vehicle.

Approx. 1 week later, information was received in the mail (see attached). The only vehicle that comes close to the description listing to WILLIAM was a 1987 Chevrolet truck. The attendant who did the search wrote in pen below the description "Chevy Suburban with auto plate--this is only one."

Information was provided to Deputy E. Glaeser who has assisted with numerous follow-up complaints in the HOCHSTETLER incident. He will make contact with WILLIAM at RONCALLI HIGH SCHOOL or at his residence to check the suspect vehicle. MJBushman /bjc

01/23/04 @ 0800 Hrs.: I, Deputy E. Glaeser, was given information from D.I. M. Bushman in regard to a possible suspect vehicle to check at RONCALLI HIGH SCHOOL. Information relayed to me was that there was a party by the name of WILLIAM KRAEMER who apparently owns a vehicle matching the description of our hit & run vehicle. This particular truck apparently has been stored in a garage on the west end of the property at RONCALLI HIGH SCHOOL. Further information relayed from D.I. Bushman was that the vehicle had been stored at this location for an extended period of time. The anonymous informant indicated they thought this was rather odd.

01/23/04 @ 0930 Hrs.: I made contact at the office of RONCALLI HIGH SCHOOL. Upon speaking with the Principal (MR. OLSON), I received permission to speak with WILLIAM KRAEMER in

MANITOWOC COUNTY SHERIFF'S DEPARTMENT
FOLLOW-UP REPORT

Page: 3

CASE NUMBER: 504-00795 CLASSIFICATION: _____

INCIDENT: _____

DATE AND TIME: _____

REPORT CONTINUED:

regard to this vehicle. In speaking with the Principal, prior to meeting with WILLIAM, he did acknowledge that WILLIAM is a maintenance employee/janitor for RONCALLI HIGH SCHOOL. He stated WILLIAM has permission to have several of his personal vehicles stored on RONCALLI HIGH SCHOOL property, in the garage facilities. According to the Principal, WILLIAM is a valued employee and they look at the storage of his vehicles as a type of "fringe benefit."

01/23/04 @ 0940 Hrs.: I, Deputy Glaeser, spoke with WILLIAM in regard to follow-up on a Crime Stopper complaint reference the suspect vehicle. WILLIAM explained to me that he did in fact store his 1987 Chevy Suburban in a garage on the west end of the RONCALLI HIGH SCHOOL property. He further relayed that he would be more than willing to allow this officer access to the vehicle so that it could be checked over.

WILLIAM escorted me to an outbuilding/garage which was on the west end of the RONCALLI HIGH SCHOOL property. Upon entering the building, WILLIAM explained that he realizes he had special privileges at the school and he considers himself very fortunate to be able to store some of his personal property in the storage buildings. It should be noted, while I was en route to this storage building, WILLIAM informed me that he was quite glad to hear that officers are still investigating Crime Stopper tips in regard to the RICHARD HOCHSTETTLER hit & run incident. WILLIAM stated his son, LUKE KRAEMER, originally called in the complaint. WILLIAM stated LUKE is now an officer for WSP and he is stationed out of Sheboygan.

Upon entering the storage building, I noted there was a dark-colored Jeep which had a trailer and several snowmobiles behind it. WILLIAM stated this vehicle belongs to LUKE. In the rear corner of the garage, I noted there was a blue tarp hanging from the ceiling and it appeared that a section of the room was cordoned off. WILLIAM directed me to the rear section of this garage. He indicated this is where the truck is stored. WILLIAM stated this particular vehicle was a 1987 Chevy Suburban. WILLIAM stated he uses the truck very seldom. He primarily uses it as a tow vehicle when he goes camping in the summer.

In observing the vehicle, it did appear to be a full-size Chevy Suburban, blue and light blue in color. The description of the vehicle, the front end specifically, would be rectangular headlamps with a square and rectangular grill. The center Chevy emblem inside the grill was large in nature and chrome in color. In observing the front headlights and headlight trim, I noted all parts did appear to be complete on the vehicle. In touching the front grill area, it did appear that one of the fasteners may have been broken from the right side of the grill, as the grill did swing out several inches, if it was manipulated by hand. There did not appear to be any missing parts of the grill or headlamp trim areas.

In speaking to WILLIAM, I noted to him that this particular vehicle was in quite nice condition and it was apparent that it had been well taken care of. WILLIAM stated the vehicle does not get used on a regular basis. He further stated that his son or his son-in-law rebuilt the vehicle for him in the past. In checking the body lines on the vehicle, I noted it was apparent the vehicle had been painted sometime in the past as in observing the door post between the front and back doors on the driver side, there was an area where

MANITOWOC COUNTY SHERIFF'S DEPARTMENT
FOLLOW-UP REPORT

Page: 4

CASE NUMBER: 504-00795 CLASSIFICATION: _____

INCIDENT: _____

DATE AND TIME: _____

REPORT CONTINUED:

the paint undercoat had not been feathered completely. It was apparent that the vehicle had been painted sometime within the recent past.

It should be noted, while I was checking the vehicle for damage, I was speaking to WILLIAM as he was standing in my near proximity. WILLIAM stated LUKE apparently had been coming home from the City of Manitowoc on the evening of the hit & run. LUKE apparently drove past the victim while he was traveling on CTH CR. According to WILLIAM, LUKE turned around and went back to the area where he located something on the side of the roadway. This was later determined to be the remains of RICHARD HOCHSTETLER. According to WILLIAM, when LUKE saw all of the blood, he realized it was a body. At that time, he traveled to the City of Manitowoc and called the incident in.

WILLIAM was asked to open the hood on the vehicle so that I could check the radiator and the fan cowling. He did comply with my request. In checking the engine compartment, I did note that the fan shroud was complete and it did not appear to be damaged.

At this point, I cross-referenced the VIN as provided by D.I. Bushman with the one displayed on the vehicle. The VIN was [REDACTED]. The RPs displayed on the vehicle were 324FBS. In running a 10-28, it did indicate that the RPs are for a 1987 Chevy Suburban, registered to WILLIAM M. or CINDY M. KRAEMER of [REDACTED] S 26th St, Manitowoc.

Upon confirming the VIN and the RP, I further asked WILLIAM if the vehicle had ever been checked during the hit & run investigation. WILLIAM stated he believed that Sgt. Senglaub had checked over the vehicle very early in the investigation. I noted that I would be checking that information, in the hopes it had been entered on our FBI program. WILLIAM also offered to me that his family owns another Suburban similar to the description of this one. He stated this was the plow truck that he keeps at his residence. I informed WILLIAM that at this point, I would not be checking that vehicle but I would note it in my report.

Upon exiting the RONCALLI HIGH SCHOOL facility, I made a telephone call to D.I. Bushman, relaying to him my findings reference inspection of the vehicle. I informed D.I. Bushman that this particular vehicle does appear to be a type match for our hit & run vehicle. I further indicated to him that WILLIAM KRAEMER was very cooperative in allowing access to the vehicle and with the vehicle's present condition, it did not appear to have damage, other than a loose grill piece on the front right side.

D.I. Bushman was informed that according to WILLIAM, it was his son, LUKE, who called the incident in. D.I. Bushman was able to acknowledge this fact. D.I. Bushman further stated that the anonymous caller who revealed the information of the vehicle's location relayed to him that LUKE apparently suffered some type of stress as a result of finding RICHARD HOCHSTETLER and allegedly sought out counseling or guidance from the priest at RONCALLI HIGH SCHOOL very near this incident time frame. I further indicated to D.I. Bushman that every attempt would be made to verify the contact information on WILLIAM'S vehicle and to attempt to verify if the vehicle had been checked in the past.

01/28/04 @ 2030 Hrs.: I, Deputy Glaeser, spoke to Deputy Raube in regard to the FBI

MANITOWOC COUNTY SHERIFF'S DEPARTMENT
FOLLOW-UP REPORT

Page: 5

CASE NUMBER: 504-00795 CLASSIFICATION: _____

INCIDENT: _____

DATE AND TIME: _____

REPORT CONTINUED:

program. I asked Deputy Raube to be sure that the program was accessible and available for verification of vehicles.

I, Deputy Glaeser, further spoke at this time with Sgt. Senglaub, asking him if he remembered a party by the name of WILLIAM KRAEMER. Sgt. Senglaub acknowledged in the affirmative that he realized who WILLIAM was. He stated WILLIAM is the janitor and maintenance man at RONCALLI HIGH SCHOOL. I asked Sgt. Senglaub if he ever checked any of WILLIAM'S vehicles in regard to the RICHARD HOCHSTETLER hit & run investigation. Sgt. Senglaub indicated to me that he could not recall ever checking any of WILLIAM'S vehicles in regard to the hit & run.

01/29/04 @ 0400 Hrs.: I, Deputy Glaeser, cross-referenced the FBI data program for information on WILLIAM KRAEMER'S vehicle. I met with negative results. The vehicle was checked by VIN, by RP, and by WILLIAM'S last name. All searches met with negative results. It does appear that the information on this particular vehicle or any vehicle owned by WILLIAM had never been entered into the system, although the possibility does exist that it may have been checked but the information was just not entered.

01/29/04 @ 1200 Hrs.: I, Deputy Glaeser, relayed the information in regard to this follow-up to D.I. Bushman.

This report can be ended, pending further follow-up. EJGlaeser /bjc

02/03/04: Deputy E. Glaeser believed there were several more questions that needed to be asked of LUKE KRAEMER, and they are listed below. LUKE is currently attending the WSP Academy and will be back to work on 02/17/04 at 1500 hours. On 02/18/04, LUKE works at 1400 hours; and on 02/19/04, he has a troop meeting to attend. LUKE works late nights on the weekends. Per District 3 Capt. Pichette, we should go ahead and call him through the District 3 radio and have him call or come to MTSO. LUKE may come in to MTSO on-duty.

Questions:

1. The 1987 Chevrolet Suburban is stored in a remote location which aroused suspicion. Even inside the building, a tarp was hung to shield the vehicle from view. If used seldom, by whom? For what? When? Where?

RESPONSE:

RONCALLI HIGH SCHOOL has an annual fund raising candle sale. When the product arrives, it is stored in the same building and is open to the public to pick up the product for delivery to their customers. WILLIAM KRAEMER does not wish to answer parents' questions about his special fringe benefit privilege to park the vehicle on the RONCALLI HIGH SCHOOL property, so it is shielded from view. The vehicle is driven by WILLIAM to pull his camper up north in the summer months, maybe 7-8 times a year.

2. The vehicle is spotless and shows sign of recent repairing. WILLIAM, the owner, acknowledges the vehicle had body work done recently by his son or father-in-law's son. Deputy Glaeser's comment was that the vehicle was "spic & span clean." When

MANITOWOC COUNTY SHERIFF'S DEPARTMENT
FOLLOW-UP REPORT

Page: 6

CASE NUMBER: 504-00795

CLASSIFICATION: _____

INCIDENT: _____

DATE AND TIME: _____

REPORT CONTINUED:

was it done?

RESPONSE:

The vehicle was repainted 5-6 years ago. There was no damage repaired, only rust fixed. As far as LUKE knows, the vehicle had never been repaired for front end damage. The vehicle was bought and used by WILLIAM.

3. LUKE located the victim while on his way home from the City of Manitowoc to his home address of [REDACTED] S 26th St. Where was he coming from? U-turn? LUKE left the scene and went into the City to report the accident. Why not home? Where was it reported?

RESPONSE:

LUKE and his friend (ANDREW SWETLIK) had gone to a dance club in Appleton the night of the incident. He was on his way home on CTH CR from dropping off friends in the City. He was driving a small Toyota car when he saw something unusual in the road. He thought it may be a body and turned around in the first driveway on Silver Creek Rd, east of CTH CR, to go back. He did not get out to check the body. He was now facing north and sped up into the City to report the incident at the SHELL STATION which he thought would be the closest phone open to the public at 0230 hours. When asked if he saw any police, he recalled seeing a squad EB on CTH CL, assuming they were headed for the gas pumps at DPW but did not see a squad at the gas station. He asked for a phone and was directed by the attendant to the pay phone. LUKE told the attendant he needed to call about a man struck by a car on CTH CR and was allowed use the regular line.

4. Deputy Glaeser felt the vehicle in storage is a very good match--the front grill, headlamp assembly, tires, and bumper height. Who checked it? WILLIAM stated he thought the truck may have been checked by Sgt. Senglaub. There is no record of the vehicle being checked in the FBI program on the computer. There is no in-house record it was checked. Sgt. Senglaub was questioned, and he responded, "I honestly don't remember. I know it wasn't at his house, maybe at school. I honestly don't remember."

RESPONSE:

WILLIAM told his son he was surprised no one from the police checked the Suburban.

5. A rumor reported LUKE needed extended counseling after finding the dead body. Counseled by whom? Can we talk to them?

RESPONSE: LUKE stated he did not receive counseling after the incident. He did talk with his parents throughout the weekend of the incident and for months after the incident, he admits he may have avoided driving through the area. He stated it still reminds him of the incident when he sees the cross which was erected on the side of the road near the accident site.

6. WILLIAM has a marriage relationship (father-in-law) with a body shop in Cleveland, that being KJ COLLISION REPAIR. The current body shop owner has a first name of "KEN" and is approx. 52 years old. The shop is in Cleveland, on Dairyland Dr, and is in the business subdivision just south of the old WAYSIDE.

RESPONSE:

WILLIAM'S Chevrolet Suburban was repainted at KJ COLLISION REPAIR. There was no impact damage, just rust.

MANITOWOC COUNTY SHERIFF'S DEPARTMENT
FOLLOW-UP REPORT

Page: 7

CASE NUMBER: 504-00795 CLASSIFICATION: _____

INCIDENT: _____

DATE AND TIME: _____

REPORT CONTINUED:

02/17/04 @ 1510 Hrs.: LUKE came to MTSO for an interview and to meet with Lt. Lenk, Det. Jacobs, and me (D.I. M. Bushman) in the Admin. Conference Room. No one was in their office, and the outer door was closed. I advised LUKE of the purpose for meeting her in private and explained the nature of the questions. LUKE showed minor symptoms of nervousness (slight finger twitch), until he was advised of the reason for our meeting. Immediately, LUKE began to relax and sit in an open posture, displaying desire to be very cooperative. He answered all questions completely and without hesitation.

Det. Jacobs and Lt. Lenk were requested to observe body language and analyze answers as I proceeded through the list. Det. Jacobs was asked if he had any additional questions, and his response was, "Absolutely not." Lt. Lenk asked LUKE if he knew how long the vehicle was stored at RONCALLI HIGH SCHOOL, and he stated he thought it was there since 1997 or 1998.

It was our group's unanimous opinion at the conclusion of this interview that LUKE was telling the truth and showed no signs of deception in his responses to our list of questions. The final question: Would WILLIAM allow officers to look at his Chevrolet Suburban one more time? The purpose of the final check is to have someone with body shop experience view it and check for replacement of front end parts. He responded, "No problem."

Contact was made with WILLIAM, and arrangements were made to view the Suburban on 03/02/04 at 1330 hours. Inspector R. Hermann will accompany me to RONCALLI HIGH SCHOOL.

03/02/04: WILLIAM, Inspector R. Hermann, and I met outside of the storage building west of RONCALLI HIGH SCHOOL. After the first look at the Chevrolet Suburban in the storage building, it was obvious that it was not the suspect vehicle. This vehicle has a different grill and headlamp design which indicated to us that it is not consistent with the parts found at the scene.

This incident can be closed. MJBushman  /bjc

MANITOWOC POLICE DEPARTMENT
STATEMENT FORM

CASE #: 599-242 OFFICER #: 158 DATE/TIME: 1/10/99 0247 hrs PAGE: 1

STATEMENT OF:

<input checked="" type="radio"/> MALE / <input type="radio"/> FEMALE	FULL NAME - Last, First & Middle Name <u>Kraemer Luke Eugene</u>	RACE <u>white</u>
ADDRESS/CITY/STATE/ZIP <u>South 26th Manitowoc WI 54220</u>	PHONE # [REDACTED]	D.O.B. [REDACTED]

On January 10th 1999 at approximately 2:10am I was traveling Southbound on County Trunk CR. I then witnessed a body laying in the middle of county Trunk CR and Silver Creek road. I turned around and headed North bound and went to Larry's Shell station to call the police to the location. I came back to the scene and noticed another vehicle stopped with her hazard lights on. I asked if she had called the police and she had called also. We then waited at the scene for police officers to arrive.

It also could be noted that as I was headed South bound the first time I did pass a ~~the~~ full size truck headed north bound, the truck did not have a cab.

SIGNATURE: Luke Kraemer WITNESS: Ben Morley

KEVIN JACKIE
WORKS FOR SAK

9/6-97 UNASSIGNED
NONE VET. FOR PROJECT

CLEVELAND BOX SHOP

~~LUKE~~ / SCOTT SENGELUB, CONSERVATION
SHOCK UN FOUND A DEAD BOAT
1ST ONE 1979
V. ACTIVE IN RELIGIOUS ACTIVITY

S99-00242

MANITOWOC POLICE DEPARTMENT
STATEMENT FORM

CASE #: 242 OFFICER #: _____ DATE/TIME: 1-10-99 0306 PAGE: _____

STATEMENT OF:

MALE / FEMALE	FULL NAME - Last, First & Middle Name	RACE
	Schindler Sandra Lee	F/W
ADDRESS/CITY/STATE/ZIP		D.O.B.
Chicago St Manitowoc, WI 54220		
PHONE #		

On 1-10-99 about 5-10 minutes after 2am I was traveling NB on HWY CR and observed someone walking SB on the west side of the road approx 1/2 mile N of Silver Creek Rd. I proceeded NB to Viebahn and made a left turn and then made another (L) turn onto Hecker Rd. I deliver papers and delivered 8 papers from the time I saw the subject and when I observed a subject lying in the middle of the road on HWY CR at Silver Creek Rd. After making the turn onto Hecker Rd. I traveled SB until Silver Creek Rd. and then made a left and proceeded to HWY CR. I made a (R) turn onto CR and observed some body laying in the middle of the road. There were no other vehicles around and I called 911 using my cellphone at 2:25 am. Between the time I observed the male walking and made a (L) turn on Viebahn I saw 2 cars and 2 trucks traveling SB on CR. I didn't observe the color or make of any of the vehicles. When I saw the body it was not moving. All 4 vehicles observed by me were not together and it was the 2 cars first and then the 2 trucks. Both trucks had caps on back. Written By Officer Jeff Hylar MPD

SIGNATURE: Sandra Schindler WITNESS: Jeffrey K Hylar

02/03/04

Reference: Questions for Luke Kraemer surrounding follow-up for S04-00795 and S99-00242. He is currently attending WSP academy until first day back to work, February 17. 17 on duty 3 PM, 18 on duty 2 PM, 19 troop meeting, late nights on the weekend. Per Capt. Pichette "go ahead and call him through District 3 radio and have him call you. He may come to MTSO on duty.

- 1) Vehicle stored in a remote location aroused suspicion, even inside the building a tarp was hung to shield it from view. Used seldom, By whom? For what? When? Where?
- 2) Vehicle is spotless, shows sign of repaint, owner acknowledges it had been redone recently by his son or son-in-law.
- 3) Luke Kraemer located the victim while on his way home from Mtwc-address [REDACTED] S.26th street. Where was he coming from? Luke left scene and went into the city to report the accident. Why not home? Where was it reported? 911?
- 4) Vehicle in storage is a very good match-front grille, headlamp, tires, and height.
- 5) Owner stated the truck was checked by Senglaub. No record through FBI file program. No in-house record it was checked. Senglaub questioned, "I honestly don't remember, I know I wasn't at his house, maybe at school, I honestly don't remember."
- 6) Luke needing extended counseling after finding a dead body.
- 7) Owner is related to (father in-law) body shop operator in Cleveland-KJ Collision Repair.

Pull tape if 911

STATEMENT

STATEMENT OF:	INCIDENT#
NAME:	PAGE OF
BIRTH DATE:	AGE: DATE:
ADDRESS:	TIME:
CITY:	STATE: ZIP:
PHONE:	
IF JUVENILE:	
FATHER:	MOTHER:
# 804-795	1-29-04 BY 417
#1 VEHICLE STORED IN REMOTE LOCATION - EVEN INSIDE BUILDING A TARP IS HUNG TO SHIELD VIEW OF TRUCK.	
#2. VEHICLE IS SPOTLESS - ALSO SHOWS SIGN OF REPAINT	
WHERE? OWNER ACK. IT HAD BEEN REDONE BY SON OR SON IN LAW	
#3. OWNER'S SON LOCATED VICTIM WHILE ON HIS WAY HOME FROM MANITOWOC - ADDRESS [REDACTED] S, 26th ST. - SON LEFT SCENE + WENT INTO CITY TO REPORT INCIDENT INSTEAD OF GOING HOME.	
#4. TYPE MATCH OF TRUCK - HEADLAMPS GRILL, ECT - INCLUDING TIRES + HEIGHT.	
#5. OWNER STATING TRUCK WAS CHECKED BY SENG LAB - SENG LAB DOESN'T REMEMBER + NO ENTRY ON FBI DATA PROGRAM	
#6. LUKE NEEDING EXTENDED COUNSELING AFTER FINDING DEAD BODY -	
#7. OWNER IS RELATED TO (FATHER IN LAW) BODY SHOP OPERATOR IN CLEVELAND - KJ COLLISION REPAIR	
WITNESS:	SIGNATURE:
WITNESS:	TIME:

1. why stoned @ Roncelli - doesn't want parents to know he parks it out there.
2. dad uses 7-8 times a year.
3. ^{repaired} ~~Asphalt~~ 5-6 years ago - no damage just rust.
- 4. '97-'98 already stoned in the Roncelli H.S.
5. truck was north bound. - not sure what kind.
6. turned around in 1st. driveway on Silver Creek Road.
7. I didn't get out to check the body at the time.
8. asked gas station attendant for the phone inside the phone.
9. father said I'm surprised they didn't check my car! (Wm. said that)
10. No counseling after contact. - just didn't drive by that area
11. for awhile.

Andy Switlik - friend

When did dad start stoning his vehicle?

02/03/04 Deputy Glaeser believed there were several more questions that needed to be asked of Luke Kraemer and they are listed below. He is currently attending Wisconsin State Patrol Academy and will be back to work, February 17, at 3 PM. On the 18th he works at 2 PM, and on the 19th he has a troop meeting to attend. He works late nights on the weekend. Per District Three Capt. Pichette, go ahead and call him through District 3 radio and have him call you or come to MTSO. He may come in to MTSO on duty.

Questions:

- 1) The 87 Chevrolet suburban is stored in a remote location which aroused suspicion. Even inside the building a tarp was hung to shield the vehicle from view. If used seldom, by whom? For what? When? Where? **Response:** Roncalli has an annual fund raising candle sale. When the product arrives, it is stored in the same building and is open to the public to pick-up the product for delivery to their customers. William Kraemer does not wish to answer parents questions about his special fringe benefit privilege to park the vehicle on Roncalli property, so it is shielded from view. The vehicle is driven by William Kraemer to pull his camper up north in the summer months, maybe 7-8 times a year.
- 2) The vehicle is spotless and shows sign of recent repainting. William Kraemer, the owner, acknowledges the vehicle had body work done recently by his son or father in-laws son. Deputy Glaeser's comment was that the vehicle was Spic & Span clean. When was it done? **Response:** The vehicle was repainted 5-6 years ago. There was no damage repaired, only rust fixed. As far as Luke knows the vehicle had never been repaired for front-end damage. The vehicle was bought used by William Kraemer.
- 3) Luke Kraemer located the victim while on his way home from the City of Manitowoc to his home address of [REDACTED] S. 2^{6th} street. Where was he coming from? U-turn? Luke left scene and went into the city to report the accident? Why not home? Where was it reported? **Response:** Luke Kraemer and friends (Andy Swetlik) had gone to a dance club in Appleton the night of the incident. He was on his way home on CTH CR from dropping off friends in the City. He was driving a small Toyota car when he saw something unusual in the road. He thought it may be a body and turned around in the first driveway on Silver Creek Road east of CTH CR to go back. He did not get out to check the body. He was now facing north and sped up into the city to report the incident at the Shell Station, which he thought would be the closest phone open to the public at 0230 hours. When asked if he saw any police he recalled seeing a squad eastbound on CTH CL assuming they were headed for the gas pump at DPW but did not see a squad at the gas station. He asked for a phone and was directed by the attendant to the pay phone. Kraemer told her he needed to call 911 about a man struck by a car on CR and was allowed to use the regular line.
- 4) Deputy Glaeser felt the vehicle in storage is a very good match. The front grille, headlamp assembly, tires, and bumper height. Who checked it? Owner stated he thought the truck may have been checked by Deputy Senglaub. There is no record of the vehicle being checked in the FBI program on computer. There is no in-house record it was checked. Deputy Senglaub was questioned, "I honestly don't remember, I know it wasn't at his house, maybe at school, I honestly don't remember." **Response:** William Kraemer told his son he was surprised no one from the police checked the suburban.

- 5) A rumor reported Luke Kraemer needed extended counseling after finding a dead body. Counseled by whom? Can we talk to them? **Response:** Luke Kraemer stated he did not receive counseling after the incident. He did talk with his parents throughout the weekend of the incident and for months after the incident he admits he may avoid driving through the area. He stated it still reminds him of the incident when he sees the cross which was erected on the side of the road near the accident sight.
- 6) William Kraemer has a marriage relationship (father in-law) with a body shop in Cleveland, the KJ Collision Repair. Current body shop owner has a first name of "Ken" and is approximately 52 years old. Shop is in Cleveland on Dairyland Drive is in the business subdivision just south of the old wayside. **Response:** William Kraemer's Chevrolet Suburban was repainted at the KJ Collision Repair. No impact damage, just rust.

02/17/04 1510 hours Luke Kraemer came to MTSO for interview and met with DI Bushman, Lt. Lenk and Det. Jacobs in the Administration conference room. No one was in their office and the outer door was closed. DI Bushman advised Luke of the purpose for meeting here in private and explained the nature of the questions. Trooper Kraemer showed minor symptoms of nervousness (slight finger twitch) until he was advised of the reason for our meeting. Immediately he began to relax and sat in an open posture displaying desire to be very cooperative. He answered all questions completely, without hesitation.

Det. Jacobs and Lt. Lenk were requested to observe body language and analyze answers as DI Bushman proceeded through the list. Det Jacobs was asked if he had any additional questions and his response was "Absolutely Not." Lt. Lenk asked Luke Kraemer if he knew how long the vehicle was stored at Roncalli? The answer; Luke thought since 97-98.

It was our groups unanimous opinion at the conclusion of this interview that Luke Kraemer was telling the truth and showed no signs of deception in his responses to our list of questions. The final question. Would William Kraemer allow officers to look at his Chevrolet Suburban one more time? The purpose of the final check is to have someone with body shop experience to view it and check for replacement of front-end parts. His response "No Problem."

Contact made with William Kraemer and arrangement made to view the suburban 03/02/04 at 1:30 PM. Inspector Hermann will accompany me to Roncalli.

03/02/04 Inspector Hermann, DI Bushman and William Kraemer met outside the storage building west of Roncalli High School. After the first look at the Chevrolet Suburban in the storage building it was obvious it was not the suspect vehicle. This vehicle has different grille and headlamp design which indicated to us it is not consistant with the parts found at the scene. This incident can be closed. M.J.Bushman

INCIDENT HISTORY DETAIL: X040330238

INITIATE: 13:58:58 02/02/04 CALL NUMBER: X0238
ENTRY: 14:00:37 CURRENT STATUS: CLOSED
DISPATCH: PRIMARY UNIT:
ONSCENE: CASE NUMBER: SO0400001130
CLOSE: 14:00:37 DISPOSITION:

LOCATION: MANITOWOC
LOCATION COMMENTS:
DAREA: MTSO
BEAT: UNK
RD:

GEO OVERRIDE
TYPE: MISC S99-000242
PRIORITY: 4

14:00:37 DW01 ENTRY TEXT:DET REMIKER REQUESTS INCIDENT
14:00:37 DW01 CLOSE CLOSED EVENT ENTERED
14:00:48 DW01 CASE SO0400001130 Assigned

OPERATOR ASSIGNMENTS: DW01 D951 XXX

MANITOWOC COUNTY SHERIFF'S DEPARTMENT INCIDENT

CASE No. S04 - 01130

- 1. Unfounded
- 2. PNL
- 3. Other
- 4. Cleared

- 1. Adult
- 2. Juvenile
- 3. Unknown
- File Approval
- Date 2-9-04



MANITOWOC COUNTY SHERIFF'S DEPARTMENT
FOLLOW-UP REPORT

Page: 2

CASE NUMBER: 504-01130 CLASSIFICATION: _____

NCIDENT: _____

DATE AND TIME: _____

REPORT CONTINUED:

V	HOCHSTETLER	146034	RICHARD	D	05/13/81		
O	HUSS	112707	ADAM	J		S 24th St, Manitowoc	

01/29/04: I, Det. Remiker, received this incident reference some follow-up to a hit & run accident that occurred in 1999. Information was received by MTSO reference a vehicle that may have been involved in the fatal hit & run accident on CTH CR (incident S99-00242).

01/29/04 @ 1620 Hrs.: I made telephonic contact with ADAM HUSS. HUSS stated he purchased a van approx. 6 months ago from an elderly female subject from the City of Two Rivers. HUSS stated he responded to an advertisement in the HERALD TIMES REPORTER and purchased the vehicle from the elderly female subject. HUSS stated, at this point, he does not know the names of the elderly couple who he purchased the vehicle from. HUSS stated he knows that the husband of the elderly couple recently passed away. HUSS stated he was told by the elderly couple that the van had been placed in storage for approx. 5 years, prior to HUSS' purchase. HUSS stated the bottom portion of the van has been recently painted.

The vehicle currently is bearing WI RP AN43711. The vehicle's VIN is [REDACTED]. The vehicle is a 1986 Chevrolet van.

HUSS stated the vehicle is normally kept in the garage at his S 24th St address in the City of Manitowoc. HUSS stated he is available at 1530 hours. HUSS stated I was welcome to stop at the residence and enter the garage to look at the van at any time.

02/02/04 @ 1530 Hrs.: I went to [REDACTED] S 24th St, Manitowoc, and attempted contact at the residence, but no one was home. I entered the north garage door entrance and observed a blue-colored Chevrolet van. The van is a Beauville model of van. The van is a full-size van. Upon inspection, the van has a 4-headlight system in front of the vehicle. The van has 2 fog lamps behind the front, plastic grill area. Also, upon inspection of the hood and windshield area, I noticed that the hood looked to be the original, factory hood. I did not observe any color discrepancies inconsistent with the other top color of the van.

Based on the information on the suspect grill and headlight assembly, I believe the vehicle that I inspected was not the vehicle involved in the fatal hit & run accident.

No further follow-up is necessary /bjc